



US00D681795S

(12) **United States Design Patent**
Huang

(10) **Patent No.:** **US D681,795 S**

(45) **Date of Patent:** **** May 7, 2013**

(54) **FAN**

(75) **Inventor:** **Ping Huang, Tainan (TW)**

(73) **Assignee:** **Sunpentown International, Inc., City of Industry, CA (US)**

(**) **Term:** **14 Years**

(21) **Appl. No.:** **29/431,101**

(22) **Filed:** **Sep. 4, 2012**

(51) **LOC (9) Cl.** **23-04**

(52) **U.S. Cl.**
USPC **D23/378; D23/328**

(58) **Field of Classification Search** D23/381-383,
D23/370-379, 385-388, 393, 394, 399, 411-414,
D23/355, 356; 454/237-253, 186, 228-236;
52/302.1; 417/423.1, 423.14; 415/182.1,
415/200, 90; 416/244 R, 246, 247 R; D6/309;
D21/430, 436, 442, 447, 450, 453, 458
See application file for complete search history.

(56) **References Cited**

U.S. PATENT DOCUMENTS

D316,599 S *	4/1991	Wang	D23/378
D416,081 S *	11/1999	Lee	D23/378
D418,913 S *	1/2000	Thakur	D23/378
D420,734 S *	2/2000	Thakur	D23/378

D424,681 S *	5/2000	Lozzio et al.	D23/378
D424,682 S *	5/2000	Thakur	D23/378
D426,631 S *	6/2000	Thakur	D23/378
D438,947 S *	3/2001	Wang	D23/378
D452,733 S *	1/2002	Thakur	D23/378
D459,467 S *	6/2002	Wilson, Jr.	D23/412
D480,130 S *	9/2003	Bucher et al.	D23/378
D482,770 S *	11/2003	Bucher et al.	D23/378
D484,965 S *	1/2004	Wong	D23/378

* cited by examiner

Primary Examiner — George D Kirschbaum

Assistant Examiner — Janice Hallmark

(74) *Attorney, Agent, or Firm* — Rosenberg, Klein & Lee

(57) **CLAIM**

The ornamental design for a fan, as shown and described.

DESCRIPTION

FIG. 1 is a perspective view of a fan showing my new design;
FIG. 2 is a front elevational view thereof;
FIG. 3 is a rear elevational view thereof;
FIG. 4 is a left side elevational view thereof;
FIG. 5 is a right side elevational view thereof;
FIG. 6 is a top plan view thereof; and,
FIG. 7 is a bottom plan view thereof.

The broken line showing of structure is included for the purpose of illustrating portions of the "article" and forms no part of the claimed design.

1 Claim, 7 Drawing Sheets

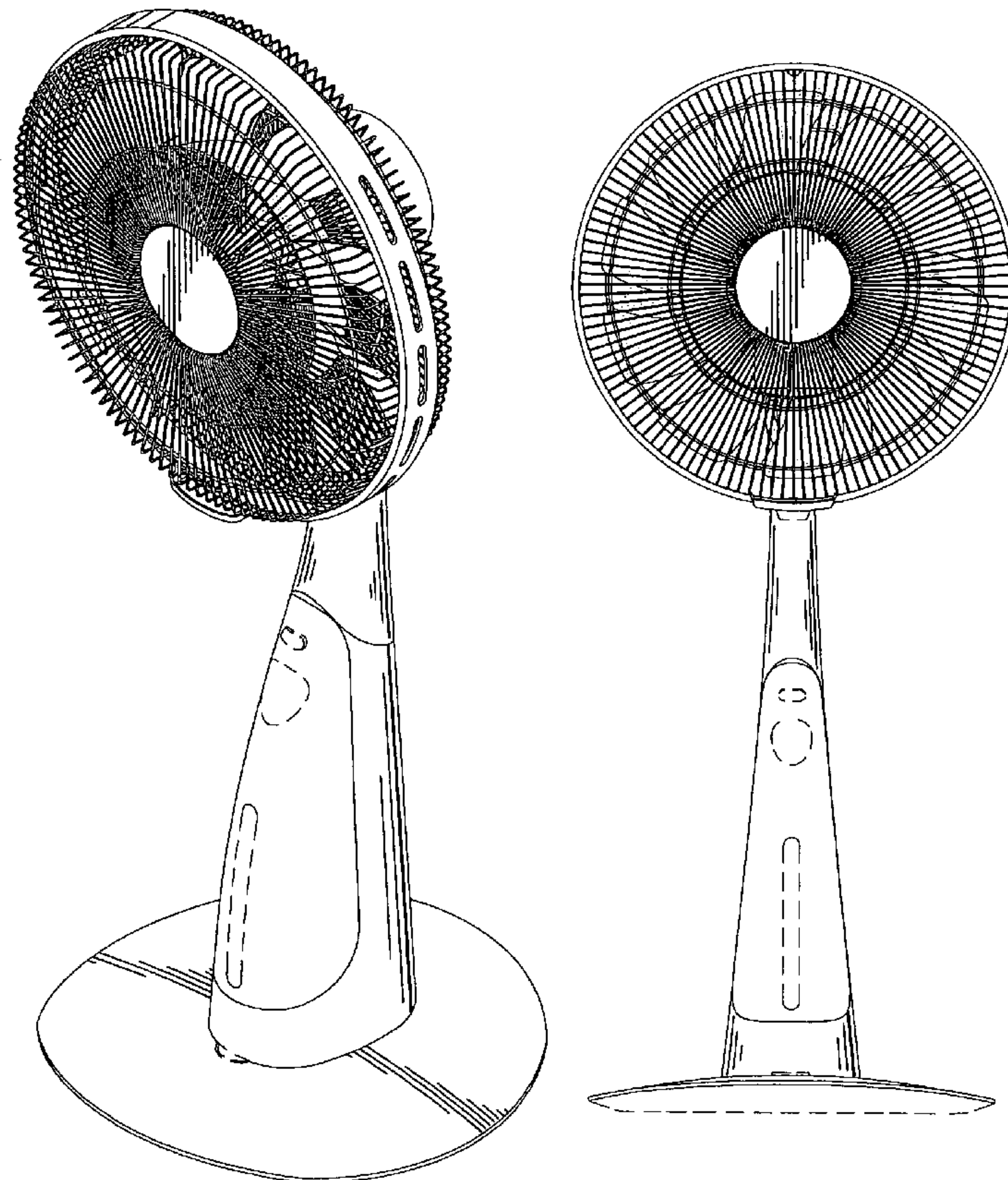

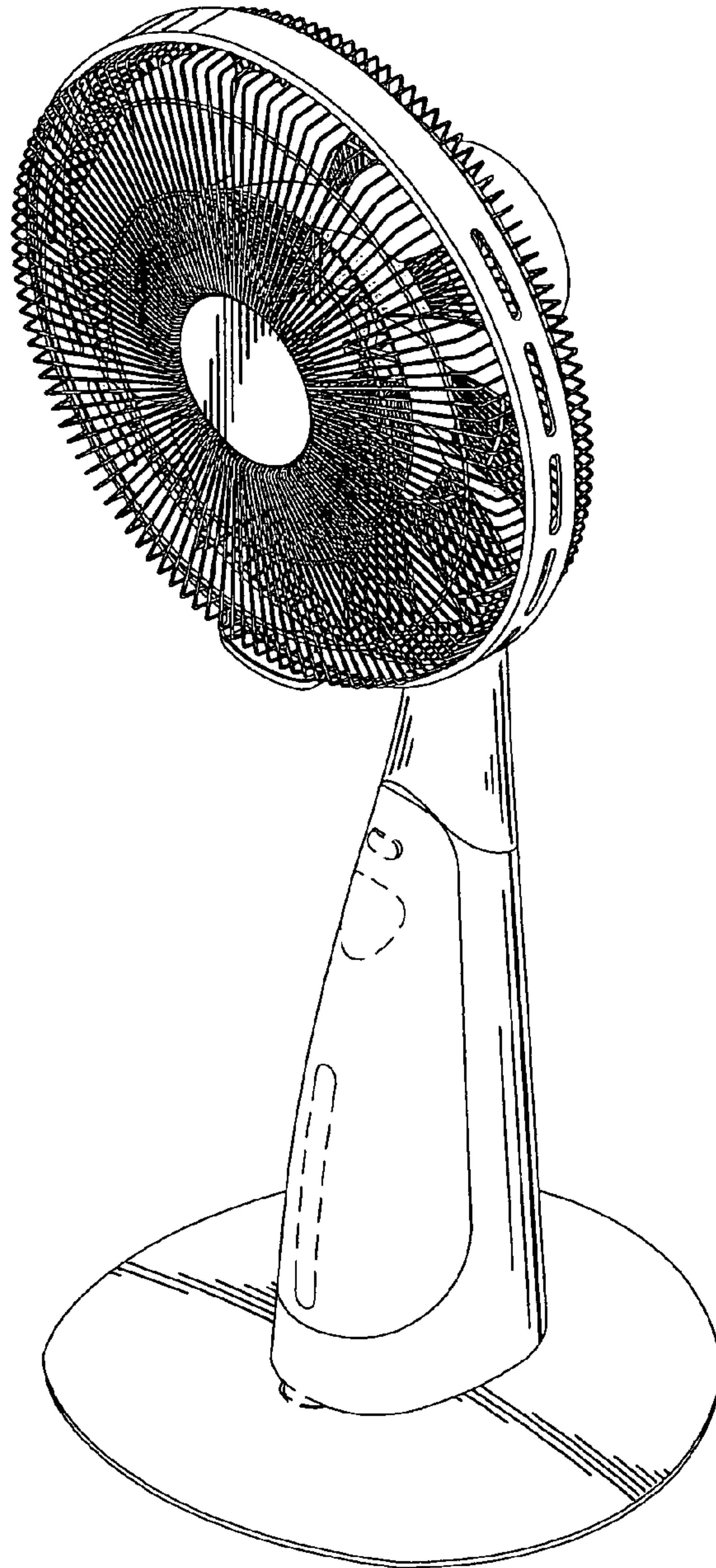

FIG. 1

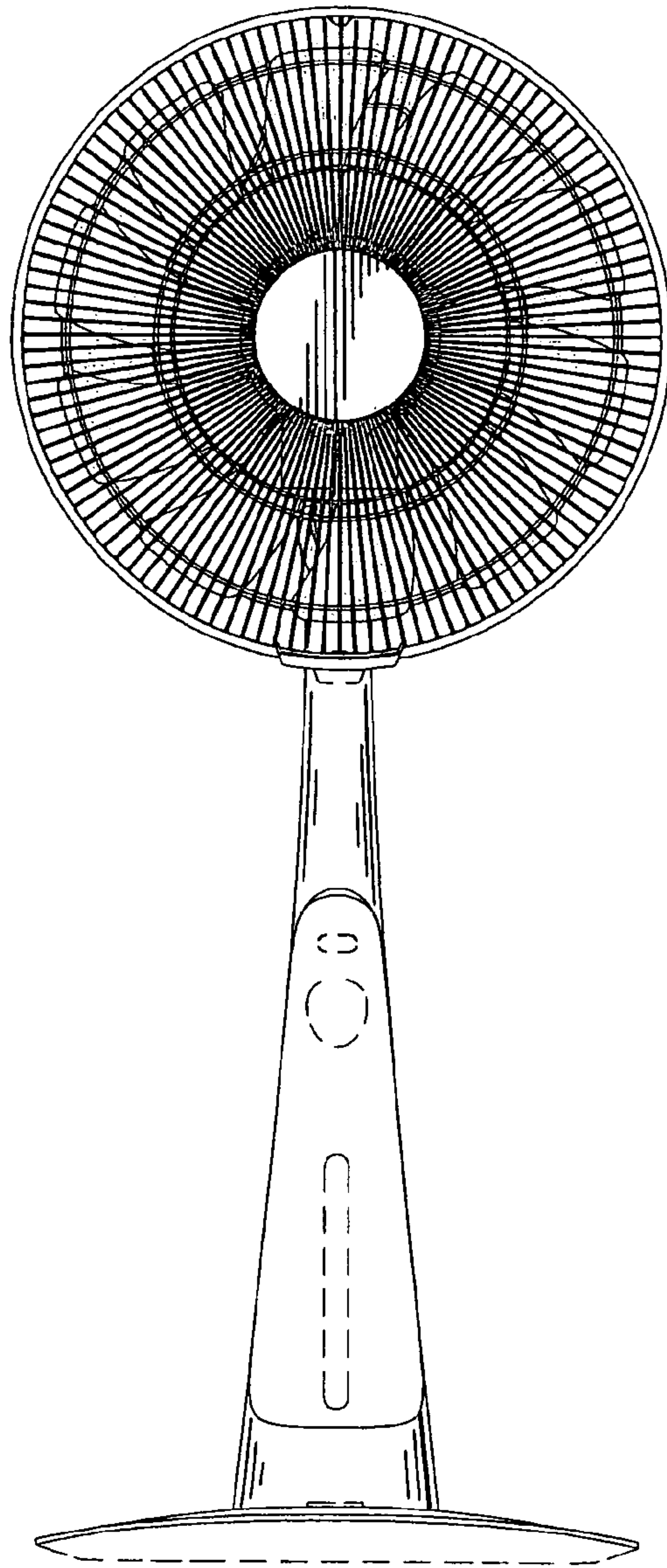

FIG. 2

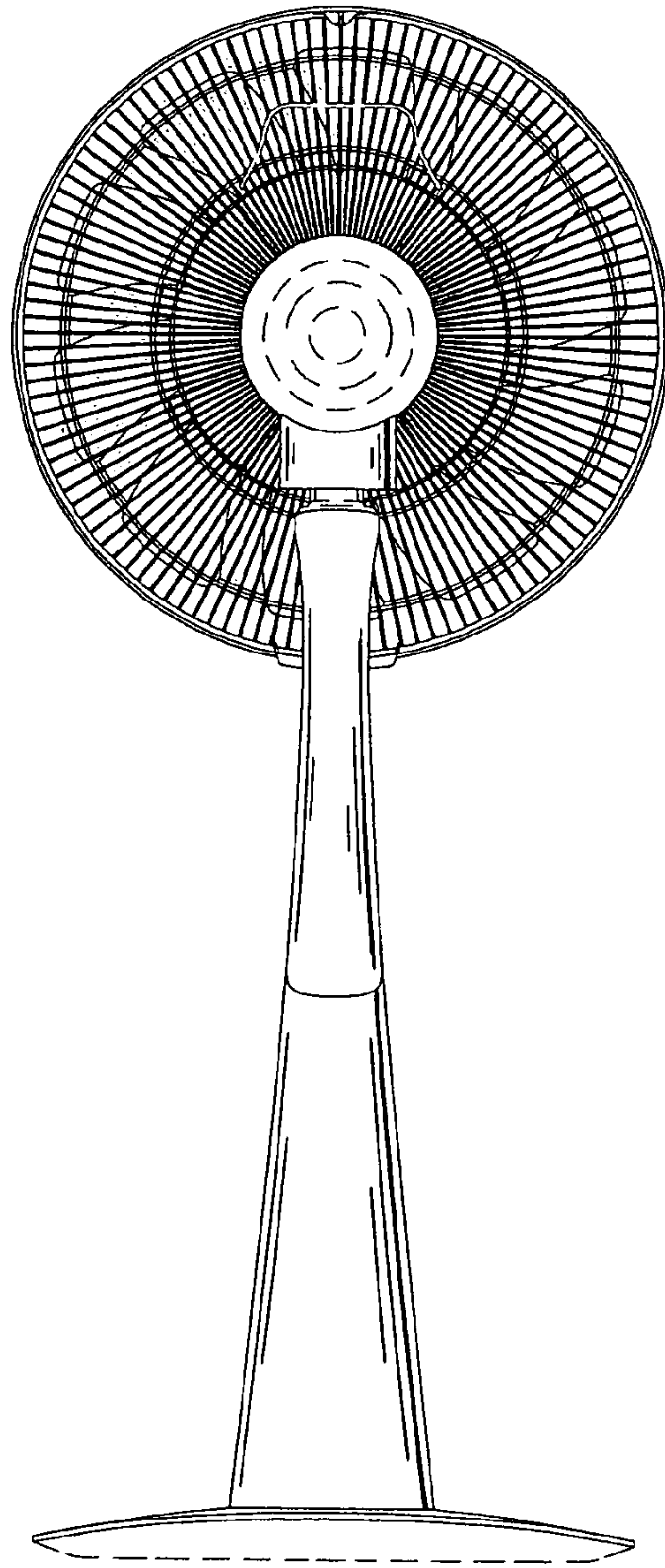

FIG. 3

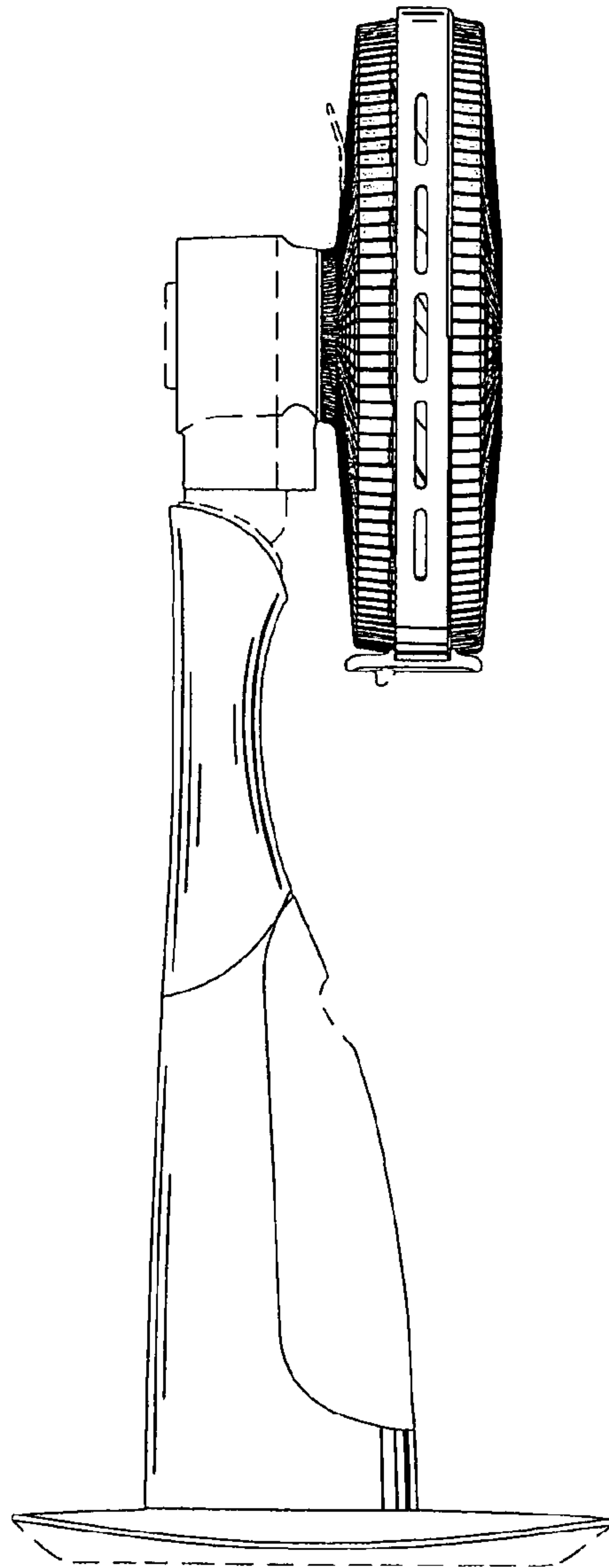

FIG. 4

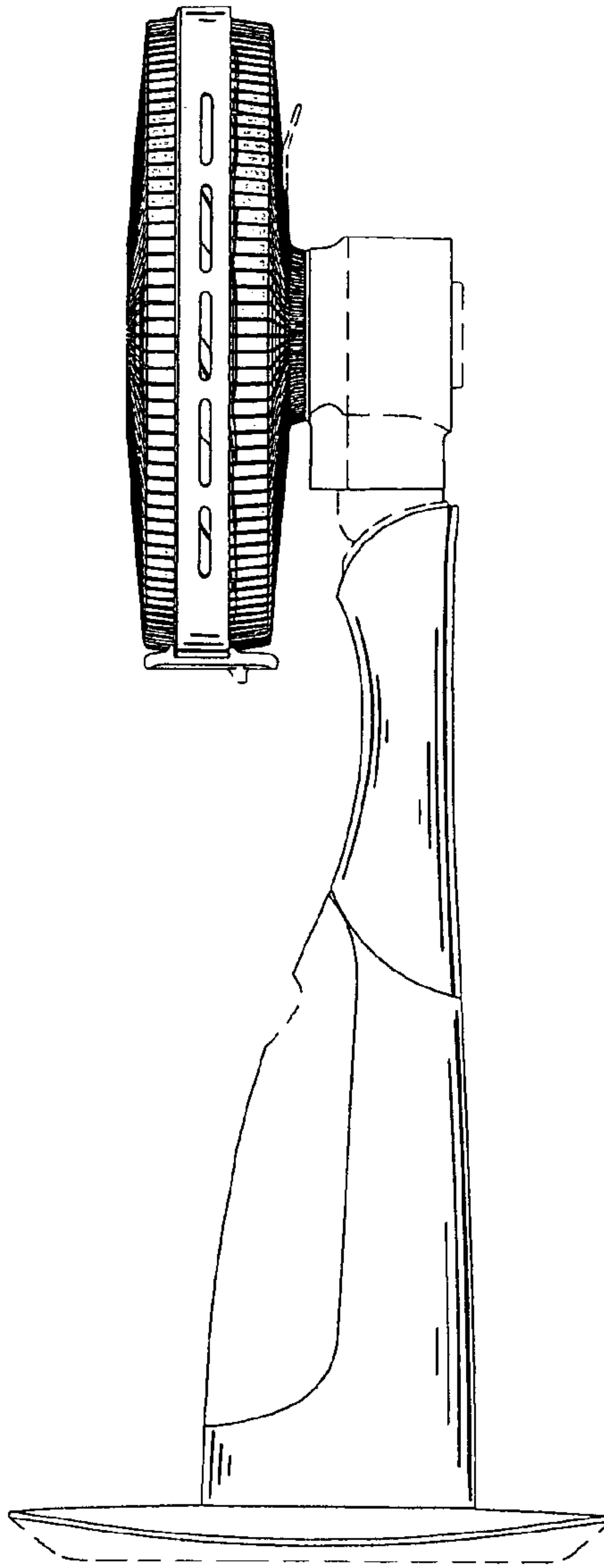

FIG. 5

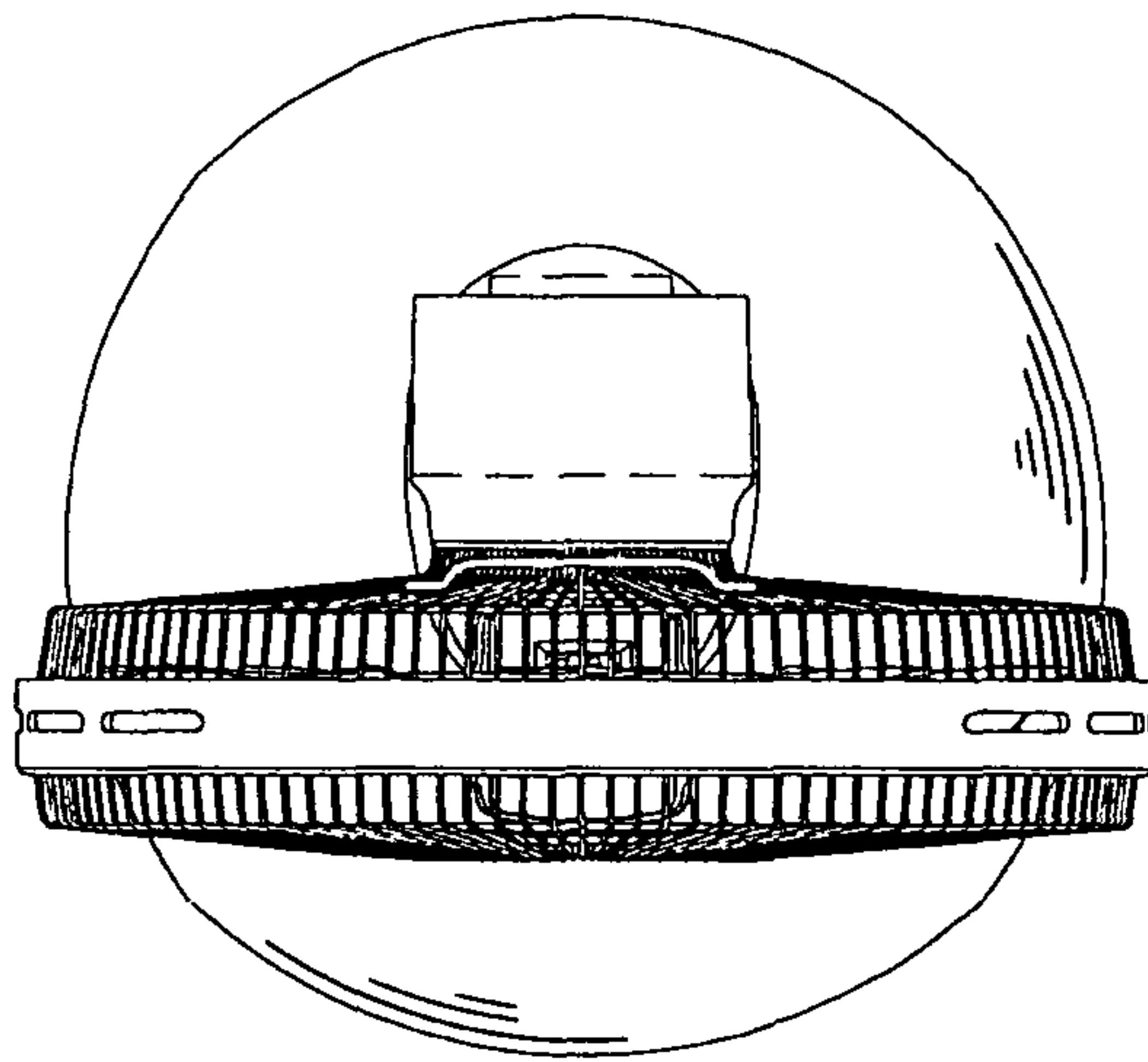

FIG. 6

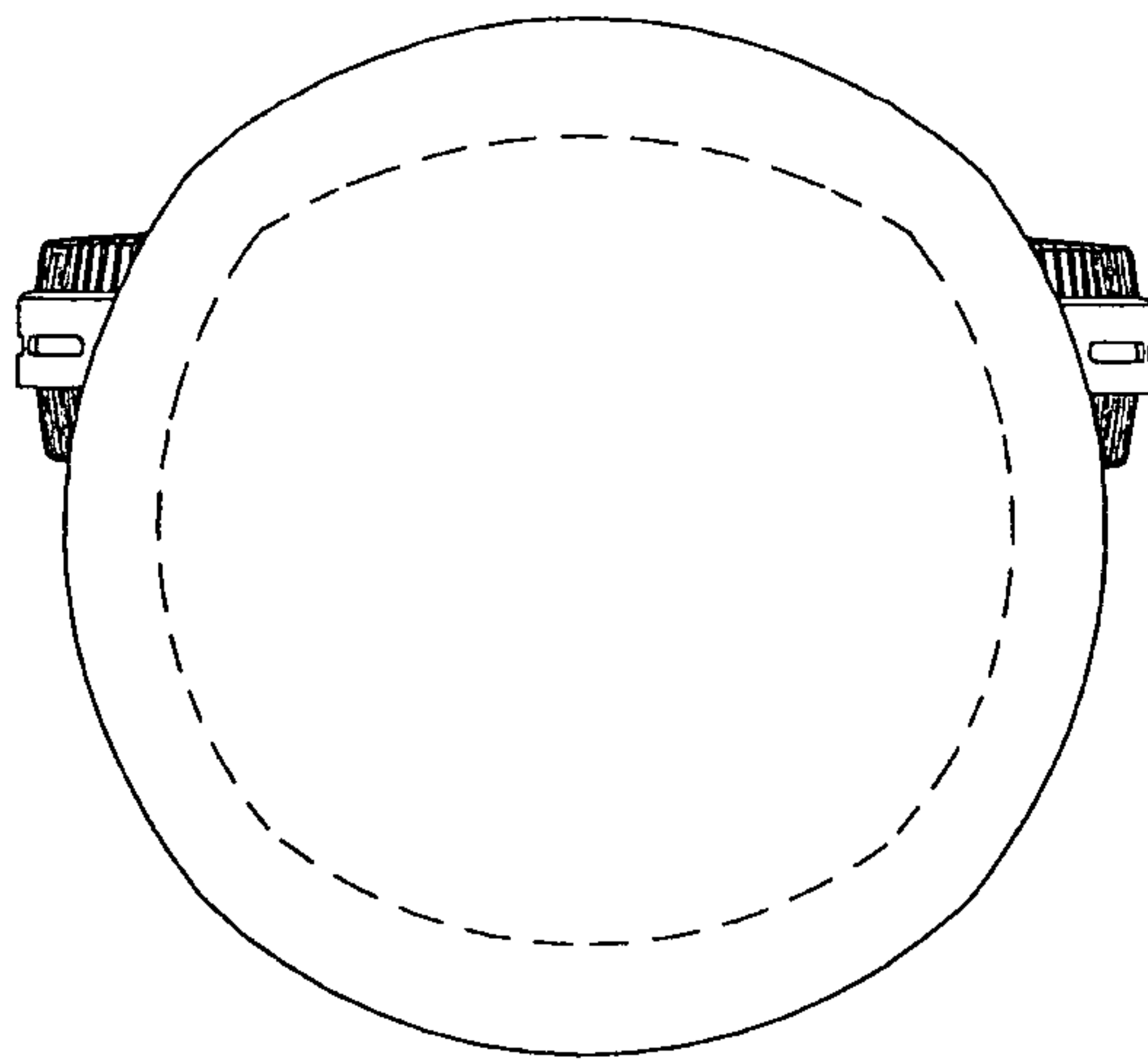

FIG. 7