



US00D681632S

(12) **United States Design Patent**
Akana et al.

(10) **Patent No.:** **US D681,632 S**
(45) **Date of Patent:** **** May 7, 2013**

(54) **ELECTRONIC DEVICE**

361/679.27, 679.3; 341/22; 348/168; 379/433.04,
379/433.07, 433.11, 916, 433.01, 433.06

(75) Inventors: **Jody Akana**, San Francisco, CA (US);
Bartley K. Andre, Menlo Park, CA
(US); **Jeremy Bataillou**, San Francisco,
CA (US); **Daniel J. Coster**, San
Francisco, CA (US); **Daniele De Iuliis**,
San Francisco, CA (US); **M. Evans**
Hankey, San Francisco, CA (US);
Julian Hoenig, San Francisco, CA (US);
Richard P. Howarth, San Francisco, CA
(US); **Jonathan P. Ive**, San Francisco,
CA (US); **Duncan Robert Kerr**, San
Francisco, CA (US); **Shin Nishibori**,
Kailua, HI (US); **Matthew Dean**
Rohrbach, San Francisco, CA (US);
Peter Russell-Clarke, San Francisco,
CA (US); **Mikael Silvanto**, San
Francisco, CA (US); **Christopher J.**
Stringer, Woodside, CA (US); **Eugene**
Antony Whang, San Francisco, CA
(US); **Rico Zorkendorfer**, San
Francisco, CA (US)

See application file for complete search history.

(56) **References Cited**

U.S. PATENT DOCUMENTS

2,424,630 A	7/1947	Perez
D262,151 S	12/1981	Sussman
D265,326 S	7/1982	Sugiyama
D270,061 S	8/1983	Ackeret
D270,062 S	8/1983	Ackeret
D270,063 S	8/1983	Ackeret
D270,066 S	8/1983	Ackeret
D278,276 S	4/1985	Bakic
4,545,023 A	10/1985	Mizzi
D284,084 S	6/1986	Ferrara, Jr.
D289,873 S	5/1987	Gemmell et al.
D306,583 S	3/1990	Krolopp et al.
D308,055 S	5/1990	Tedham et al.
D317,609 S	6/1991	Wei
D321,215 S	10/1991	Shamis
D332,328 S	1/1993	Lombardi, Jr.
D333,574 S	3/1993	Ackeret
D337,322 S	7/1993	Tso
D337,569 S	7/1993	Kando
D340,701 S	10/1993	Takeuchi
D340,917 S	11/1993	Sakaguchi et al.
D345,346 S	3/1994	Alfonso et al.
D346,589 S	5/1994	Andros
D346,793 S	5/1994	Iino et al.
5,345,543 A	9/1994	Capps et al.
5,347,295 A	9/1994	Agulnick et al.
5,398,310 A	3/1995	Tchao et al.
D361,552 S	8/1995	Iino
5,463,725 A	10/1995	Henckel et al.
5,488,204 A	1/1996	Mead et al.
5,495,566 A	2/1996	Kwatinetz
D395,639 S	6/1998	Ham et al.
D396,215 S	7/1998	Inukai
D408,372 S	4/1999	Ota et al.
D408,794 S	4/1999	Ogasawara
D409,185 S	5/1999	Kawashima
D410,440 S	6/1999	Carnell
D412,157 S	7/1999	Stevenson
D420,354 S	2/2000	Morales
D424,535 S	5/2000	Peltola
D425,887 S	5/2000	Edwards et al.
6,061,063 A	5/2000	Wagner et al.
6,067,068 A	5/2000	Hussain
D438,201 S	2/2001	Ogawa et al.
D444,465 S	7/2001	Do

(73) Assignee: **Apple Inc.**, Cupertino, CA (US)

(**) Term: **14 Years**

(21) Appl. No.: **29/429,478**

(22) Filed: **Aug. 11, 2012**

(51) **LOC (9) Cl.** **14-02**

(52) **U.S. Cl.**
USPC **D14/341**

(58) **Field of Classification Search** D14/341-347,
D14/137, 138, 138.1, 138 AA, 138 R, 138 AB,
D14/138 AD, 138 G, 138 A, 496, 426, 429,
D14/129, 130, 420, 439-441, 448, 125, 147,
D14/156, 218, 250, 389, 336, 203.1, 203.3,
D14/203.4, 203.7, 315; D21/324, 329, 330;
D10/65, 104; D18/6-7; 345/169, 901, 905,
345/156, 157, 168, 173; 361/814, 680, 686,

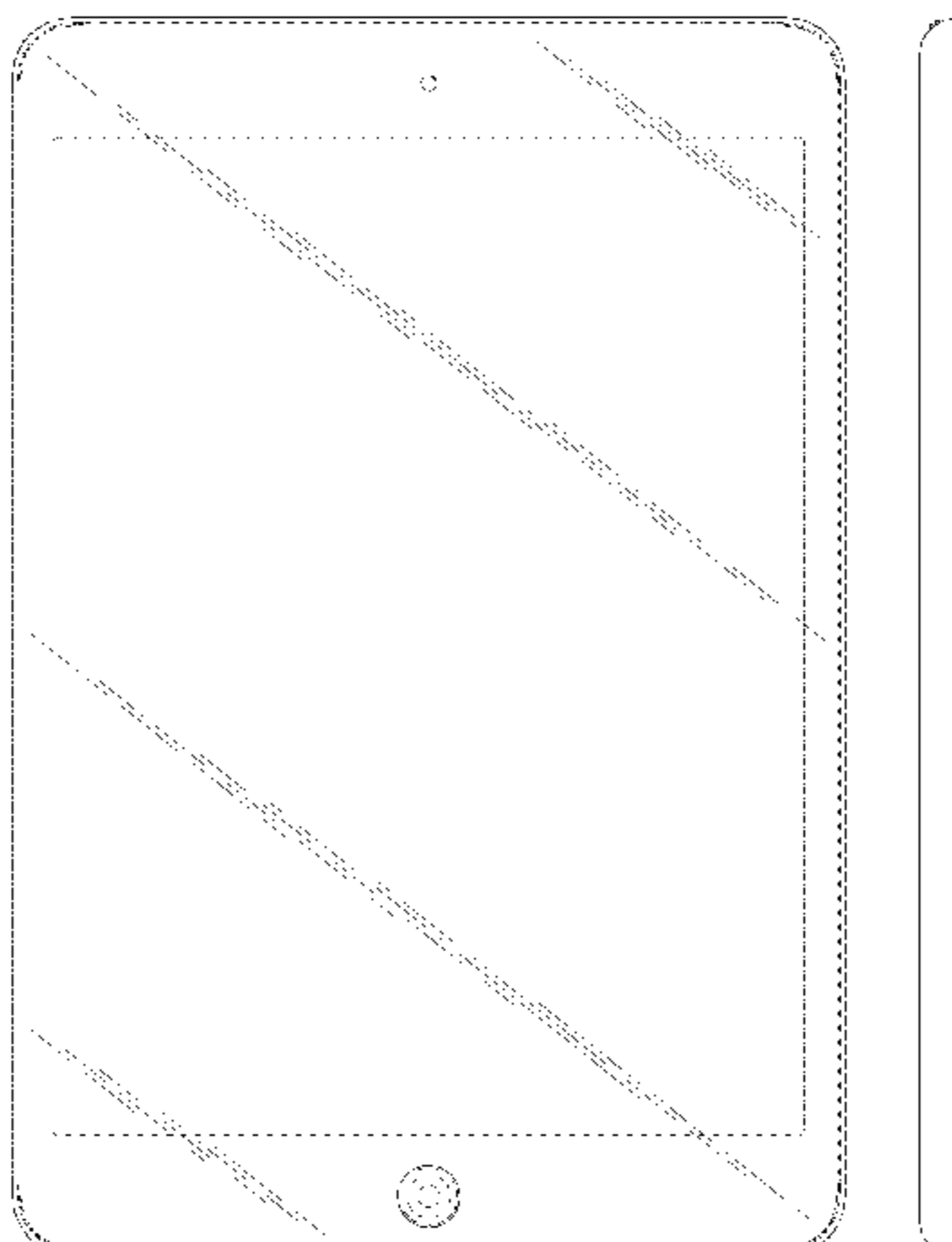

US D681,632 S

D448,764 S	10/2001	Marsalka et al.	D630,630 S	1/2011	Andre et al.
6,310,610 B1	10/2001	Beaton et al.	D633,090 S	2/2011	Andre et al.
D452,687 S	1/2002	Yeh	D633,091 S	2/2011	Andre et al.
6,337,698 B1	1/2002	Keely, Jr. et al.	D633,092 S	2/2011	Andre et al.
D453,333 S	2/2002	Chen	D634,319 S	3/2011	Andre et al.
D454,348 S	3/2002	Yeh	D634,742 S	3/2011	Andre et al.
D455,433 S	4/2002	Alviar et al.	D635,540 S	4/2011	Kim et al.
D456,023 S	4/2002	Andre et al.	D635,952 S	4/2011	Park et al.
D456,805 S	5/2002	Ono et al.	D636,390 S	4/2011	Andre et al.
D457,530 S	5/2002	Amron	D636,392 S	4/2011	Akana et al.
D458,252 S	6/2002	Palm et al.	D636,769 S	4/2011	Wood et al.
D461,175 S	8/2002	Yokota	D636,770 S	4/2011	Li
D461,802 S	8/2002	Tu	D637,596 S	5/2011	Akana et al.
D466,096 S	11/2002	Takada	D638,815 S	5/2011	Lee et al.
D466,501 S	12/2002	Hirota	D638,835 S	5/2011	Akana et al.
D467,890 S	12/2002	Lai et al.	D641,018 S	7/2011	Lee et al.
6,501,967 B1	12/2002	Mäkelä et al.	D642,563 S	8/2011	Akana et al.
D469,413 S	1/2003	To et al.	D644,218 S	8/2011	Akana et al.
6,509,907 B1	1/2003	Kuwabara	D645,017 S	9/2011	Kim et al.
D469,762 S	2/2003	Iwama et al.	D645,435 S	9/2011	Kim et al.
D483,032 S	12/2003	Bertrand et al.	D645,833 S	9/2011	Seflic et al.
D483,359 S	12/2003	Lin et al.	D645,835 S	9/2011	Lee et al.
D486,149 S	2/2004	Kawami et al.	D646,249 S	10/2011	Kim et al.
6,690,387 B2	2/2004	Zimmerman et al.	D646,252 S	10/2011	Kim et al.
D489,731 S	5/2004	Huang	D648,693 S	11/2011	Kim et al.
D490,420 S	5/2004	Solomon et al.	D649,968 S	12/2011	Li
D492,684 S	7/2004	Ozolins et al.	D650,381 S	12/2011	Park et al.
D496,362 S	9/2004	Ozolins et al.	D652,812 S	1/2012	Kim
D496,363 S	9/2004	Ozolins et al.	D652,813 S	1/2012	Song et al.
D497,364 S	10/2004	Ozolins et al.	D653,230 S	1/2012	Kim et al.
6,822,625 B2	11/2004	Shahoian et al.	D653,642 S	2/2012	Han
D502,944 S	3/2005	Kawami et al.	D653,645 S	2/2012	Park
D504,889 S	5/2005	Andre et al.	D654,041 S	2/2012	Jung et al.
D534,516 S	1/2007	Lheem	D654,049 S	2/2012	Chung
D534,517 S	1/2007	Cho et al.	D654,460 S	2/2012	Kim et al.
D540,203 S	4/2007	Jeon	D654,461 S	2/2012	Kim et al.
D543,183 S	5/2007	Cho et al.	D654,463 S	2/2012	Han
D543,979 S	6/2007	Lee	D654,497 S	2/2012	Lee
D548,713 S	8/2007	Lee et al.	D654,889 S	2/2012	Kim et al.
D548,747 S	8/2007	Andre et al.	D654,890 S	2/2012	Jung et al.
D556,211 S	11/2007	Howard	D654,891 S	2/2012	Kim et al.
D557,259 S	12/2007	Hirsch	D654,894 S	2/2012	Kim
D560,227 S	1/2008	Bennett et al.	D654,898 S	2/2012	Kim
D572,694 S	7/2008	Park	D654,899 S	2/2012	Jung
D573,143 S	7/2008	Park et al.	D654,900 S	2/2012	Jung
D575,760 S	8/2008	Kim et al.	D656,136 S	3/2012	Lee
D577,703 S	9/2008	Lee et al.	D662,100 S	6/2012	Van Den Nieuwenhuizen et al.
D580,387 S	11/2008	Andre et al.	D663,287 S *	7/2012	Kim et al. D14/218
D580,431 S	11/2008	Morita	D663,298 S	7/2012	Song et al.
D583,346 S	12/2008	Jung et al.	D664,540 S	7/2012	Kim et al.
D583,373 S	12/2008	Chen	D669,077 S *	10/2012	McManigal et al. D14/374
D584,711 S	1/2009	Kim et al.	D670,692 S	11/2012	Akana et al.
D592,211 S	5/2009	Ichise et al.	D676,819 S *	2/2013	Choi D14/138 G
D592,212 S	5/2009	Hamada et al.	D676,824 S *	2/2013	Lee D14/138 G
D593,059 S	5/2009	Kim et al.	D677,255 S *	3/2013	McManigal et al. D14/341
D594,863 S	6/2009	Ichise et al.	D677,644 S *	3/2013	Park D14/138 G
D597,067 S	7/2009	Oh et al.	D677,658 S *	3/2013	Akana et al. D14/341
D600,690 S	9/2009	Miyaji	D677,659 S *	3/2013	Akana et al. D14/341
D601,558 S	10/2009	Andre et al.	2003/0125079 A1	7/2003	Park et al.
D602,015 S	10/2009	Andre et al.	2003/0125094 A1	7/2003	Hyun et al.
D602,486 S	10/2009	Andre et al.	2003/0125959 A1	7/2003	Palmquist et al.
D602,488 S	10/2009	Jiang et al.	2003/0184525 A1	10/2003	Tsai
D604,297 S	11/2009	Andre et al.	2003/0206202 A1	11/2003	Moriya
D607,428 S	1/2010	Kim et al.	2004/0021676 A1	2/2004	Chen et al.
7,658,675 B2	2/2010	Hotta	2004/0041504 A1	3/2004	Ozolins et al.
7,688,574 B2	3/2010	Zadesky et al.	2005/0156902 A1	7/2005	McPherson et al.
D613,735 S	4/2010	Andre et al.			
D613,736 S	4/2010	Andre et al.			
D615,083 S	5/2010	Andre et al.			
D620,004 S	7/2010	Andre et al.			
D621,825 S	8/2010	Andre et al.			
D623,184 S	9/2010	Green et al.			
D624,914 S	10/2010	Wang			
D625,307 S	10/2010	Cheng			
D627,343 S	11/2010	Andre et al.			
D627,777 S	11/2010	Akana et al.			
D627,778 S	11/2010	Akana et al.			
D629,799 S	12/2010	Andre et al.			
D630,207 S	1/2011	Seong			

FOREIGN PATENT DOCUMENTS

AU	315078	7/2007
CA	72548	5/1993
CA	89155	3/2000
CA	101263	1/2004
CN	1695105 A	11/2005
CN	301499241 S	3/2011
DE	40104198-0001	9/2001
DE	40301867-0001	9/2003
DE	40705936-0001	5/2008
EH	000748280-0001	8/2007
EM	00048061-0001	8/2003

US D681,632 S

Page 3

EM	00046198-0001	11/2003	JP	D1188041	10/2003
EM	000181607-0001	8/2004	JP	2003-330613	11/2003
EM	000317490-0001	5/2005	JP	D1194485	1/2004
EM	000328265-0001	6/2005	JP	D1204221	5/2004
EM	000257621-0004	7/2005	JP	2004-290256	10/2004
EM	000375191-0001	9/2005	JP	001235888	4/2005
EM	000401898-0003	11/2005	JP	001241638	6/2005
EM	000493721-0002	5/2006	JP	D1241383	6/2005
EM	000569157-0005	9/2006	JP	D1247215	8/2005
EM	000614565-0001	12/2006	JP	D1250487	9/2005
EM	00066789-0001	3/2007	JP	D1263649	2/2006
EM	000718770-0007	6/2007	JP	001280315	9/2006
EM	000748280-0006	8/2007	JP	D1285057	10/2006
EM	000767959-0001	8/2007	JP	D1295003	2/2007
EM	000748314-0001	10/2007	JP	D1302929	6/2007
EM	000891809-0003	4/2008	JP	D1325539	3/2008
EM	000939731-0001	6/2008	JP	D1351273	2/2009
EM	001005839-0007	3/2009	KP	30-0418422-1	7/2006
EM	001098149-0001	4/2009	KR	30-0037851	8/1982
EM	001143010-0005	7/2009	KR	30-0109896	11/1990
EM	001677816-0002	4/2010	KR	30-0110034	11/1990
EM	001214290-0003	6/2010	KR	30-0213519	4/1998
EM	001222905-0001	10/2010	KR	30-0222985-1	2/1999
EM	001222905-0002	10/2010	KR	30-0237641	6/1999
EM	001767435-0001	10/2010	KR	30-0241312	7/1999
EM	001772252-0001	10/2010	KR	30-0243584	8/1999
EM	001000152-0001	11/2010	KR	30-0288858	1/2002
EM	001140115-0001	11/2010	KR	30-0291915	2/2002
EM	001802315-0001	1/2011	KR	30-0294002	3/2002
EM	001884156-0001	7/2011	KR	30-0296928	5/2002
EP	0 701 220 B1	7/2001	KR	30-0297741	5/2002
ES	I0147763	3/2001	KR	30-0304213	8/2002
ES	D0505712-01	4/2008	KR	30-0307008	9/2002
ES	D0511177	11/2010	KR	30-0307235	9/2002
FI	4897	7/1980	KR	30-0307307	9/2002
FR	990052-001	5/1999	KR	30-0309692	10/2002
FR	985598-001	10/2001	KR	30-0312151	11/2002
FR	985598-002	10/2001	KR	30-0312152	11/2002
FR	985598-003	10/2001	KR	30-0327126	6/2003
FR	985598-004	10/2001	KR	30-0330831	8/2003
GB	1042780	12/1986	KR	30-0332851	9/2003
GB	1058720	11/1989	KR	30-0336260	10/2003
GB	1058721	11/1989	KR	30-0338781	11/2003
GB	2030050	10/1992	KR	2003-0088374	11/2003
GB	2033245	8/1993	KR	30-0338886	12/2003
GB	2101448	10/2000	KR	30-0326632-2	1/2004
GB	2103809	2/2001	KR	30-0398307	11/2005
GB	3009998	1/2003	KR	30-0394921-1	12/2005
GB	3010002	1/2003	KR	30-0418547	7/2006
GB	3014024	8/2003	KR	30-0422221	8/2006
GB	3022447	10/2005	KR	30-0422222	8/2006
JP	61-69284	4/1986	KR	30-0424148	9/2006
JP	4-370868	12/1992	KR	30-0441230	2/2007
JP	886431	12/1993	KR	30-0452432	6/2007
JP	887388	12/1993	KR	30-0452985	8/2007
JP	6-102341	4/1994	KR	30-0529167	5/2009
JP	000921403	3/1995	KR	30-0533504	7/2009
JP	949744	3/1996	KR	30-0546031	11/2009
JP	953136	5/1996	KR	30-0598018	5/2011
JP	9-325180	12/1997	KR	30-0598021	5/2011
JP	001009317	5/1998	NO	082652	11/2010
JP	11-112918	4/1999	SE	55044	10/1993
JP	11-126149	5/1999	SE	2001/0343	9/2002
JP	11-289169	10/1999	TW	584453	4/2004
JP	1056385	12/1999	TW	D106137	8/2005
JP	2000-163031	6/2000	TW	D137754	11/2010
JP	2000-322495	11/2000	WO	WO 00/74240 A1	12/2000
JP	2001-22471	1/2001	WO	WO 01/88679	11/2001
JP	2001-22704	1/2001	WO	WO 2004/023272 A2	3/2004
JP	001104685	3/2001			
JP	D1124750	10/2001			
JP	D1142127	5/2002			
JP	D1143615	6/2002			
JP	D1145748	7/2002			
JP	2002-254614	9/2002			
JP	D1155168	10/2002			
JP	D1155176	10/2002			
JP	D1159881	12/2002			
JP	D1178470	7/2003			

OTHER PUBLICATIONS

“A Day in the Life of InfoLink,” Stanford University Libraries, published May 1, 2003.
 “The Oracle: The Personal Computer of the Year 2000,” Stanford University Libraries.
 “The Organizer: The Personal Computer of the Year 2000,” Stanford University Libraries.
 01net, “Fiche Technique Philips SPH8008,” (<http://www.01net.com/fiche-produit/fiche-technique-7075/cadres-numeriques-philips-sph8008/>), retrieved Nov. 21, 2011, 7 pages.

- 01net, "Fiche Technique Philips SPH8008," (<http://www.01net.com/images/produit/full/philips-sph8008-1.jpg>), retrieved Nov. 21, 2011, 1 page.
- 01net, "Fiche Technique Philips SPH8008," (<http://www.01net.com/images/produit/full/philips-sph8008-2.jpg>), retrieved Nov. 21, 2011, 1 page.
- 01net, "Fiche Technique Philips SPH8008," (<http://www.01net.com/images/produit/full/philips-sph8008-3.jpg>), retrieved Nov. 21, 2011, 1 page.
- 01net, "Fiche Technique Philips SPH8008," (<http://www.01net.com/images/produit/full/philips-sph8008-4.jpg>), retrieved Nov. 21, 2011, 1 page.
- Akihabara News Team, "Electricpig Gets Hands On Hannspad Android Tablet," (<http://en.akihabaraneews.com/73543/tablet-pda/electricpig-gets-hands-on-hannspad-android-tablet>), published Nov. 22, 2010, 1 page.
- Aliexpress.com, "WACOM PL-500 15" LCD Tablet Mint," (<http://www.aliexpress.com/product-fm/430172068-WACOM-PL-500-15-LCD-Tablet-Mint-Worldwide-Free-Shipping-wholesalers.html>), accessed Nov. 14, 2011, 3 pages.
- Allan, "Hannspad Android tablet: photos and video," Electricpig.co.uk, (<http://www.electricpig.co.uk/2010/11/18/hannspad-android-tablet-photos-and-video/>), published Nov. 18, 2010, 6 pages.
- Amazon, "Developing Tablet PC Applications—(Charles River Media Programming)," (<http://www.amazon.co.uk/Developing-Tablet-Applications-Charles-Programming/dp/1584502525>), retrieved Jul. 20, 2011, 4 pages.
- Amazon, "STL Deutschland Digitaler Bilderrahmen DF-711 B," (<http://www.amazon.de/STL-Deutschland-Digitaler-Bilderrahmen-DF-711/dp/B002D5K6YK>), retrieved Nov. 21, 2011, 4 pages.
- Amazon.com, "Digitalway MPIO FL100 128 MB MP3 Player" (<http://www.amazon.com/Digitalway-MPIO-FL100-128-Player/dp/B00008V6NI>), accessed Nov. 17, 2011, 7 pages.
- Amazon.com, "Whirlpool Gold : GH7208XRS 2.0 cu. ft. Velos Speedcook Over the Range Microwave Oven," (<http://www.amazon.com/Whirlpool-Gold-GH7208XRS-Speedcook-Microwave/dp/B000ZIPHM8>), accessed May 23, 2012, 5 pages.
- AndroidTabletFanatic.com "16 Old-Skool Tablets Rocking it Before the iPad," (<http://www.androidtabletfanatic.com/android-tablet-news/16-old-skool-tablets-rocking-it-before-the-ipad/>), published May 16, 2011, 10 pages.
- Apple Computer, Inc., "Apple Cinema Display," 1999, 21 pages.
- Apple Computer, Inc., "Setting Up Your Studio Display 15-Inch flat panel monitor," 1999, 37 pages.
- Apple, Inc., "iPod touch (2nd generation)," (<http://support.apple.com/kb/ht1353>), retrieved Nov. 21, 2011, 1 page.
- Arrington, M., TechCrunch, "We Want A Dead Simple Web Tablet for \$200. Help Us Build It.," (<http://techcrunch.com/2008/07/21/we-want-a-dead-simple-web-tablet-help-us-build-it/>), published Jul. 21, 2008, 4 pages.
- Arrington, Michael, CrunchPad: The Launch Prototype, 17 pages, <http://techcrunch.com/2009/06/03/crunchpad-the-launch-prototype/>, Jun. 3, 2009.
- Arrington, Michael, TechCrunch Tablet Update: Prototype B, 25 pages, <http://techcrunch.com/2009/01/19/techcrunch-tablet-update-prototype-b/>, Jan. 19, 2009.
- Association for Computing Machinery, The Open Video Project, "ACM CHI 1995—The Tablet Newspaper: A vision for the Future," (<http://www.open-video.org/details.php?videoid=8315&surrogate=storyboard>), 3 pages (1994).
- ASUS Computer Inc., "ASUS Tablet Computers—Providing Choice through Innovation at CES 2011," (<http://milandesignweek2011.asus.com/archives/ces-2011/asus-tablet-computers-providing-choice-through-innovation-at-ces-2011/>), published Jan. 4, 2011, 4 pages.
- Aumente, J., American Journalism Review, "Panel Vision," (<http://www.ajr.org/Article.asp?id=1257>), published Oct. 1994, 7 pages.
- Axiotron, Macworld Expo 2009 Wrap-Up, 4 pages, <http://www.axiotron.com/index.php?id=events>.
- Ballmer, S., Spiegel Online, "Bill Gates, Tablet PC: "Mira" war 2002 die große Vision des Microsoft-Gründers—kam aber wohl zu früh für den Markt," (<http://www.spiegel.de/netzwelt/gadgets/bild-670427-46770.html>), product announced 2002, 4 pages.
- Ballmer, S., Spiegel Online, "Tablet PC," (<http://www.spiegel.de/netzwelt/gadgets/0,1518,670427,00.html>), published Jan. 6, 2010, 6 pages.
- Blandford, "Nokia N92 Preview," (http://www.allaboutsymbian.com/features/item/Nokia_N92_Preview.php), published Nov. 23, 2005, 10 pages.
- Blickenstorfer, C., PenComputing Magazine, "Tablet PCs: HP Compaq Tablet PC TC1000," (http://pencomputing.com/frames/tpc_compaq.html), 3 pages (Dec. 2002).
- Blickenstorfer, C., PenComputing Magazine, "Tablet PCs: Motion Computing M1200," (http://pencomputing.com/frames/tpc_motion1200.html), 3 pages (Dec. 2002).
- Blickenstorfer, C., PenComputing Magazine, "Tablet PCs: ViewSonic V1100," (http://pencomputing.com/frames/tpc_viewsonic.html), 3 pages (Dec. 2002).
- Block, "Olympus @ CES Hands-on with the m:robe MR-500i and MR-100," Engadget.com, (<http://www.engadget.com/2005/01/10/olympus-ces-hands-on-with-the-m-robe-mr-500i-and-mr-100>), published Jan. 10, 2005, 3 pages.
- Block, "Philips PET830 and PET1030 media players," Engadget, (<http://www.engadget.com/2006/11/29/philips-pet830-and-pet1030-media-players/>), published Nov. 29, 2006, 2 pages.
- Boggs, "Electrovaya Scribbler SC4000 Review," Tablet PC Review, (<http://www.tabletpcreview.com/default.asp?newsID=1130>), published Apr. 15, 2008, 6 pages.
- Bookeen, "New Cybook OPUS," (<http://www.bookeen.com/ebook/ebook-reading-deviceaSPX>), retrieved Apr. 26, 2010, 2 pages.
- Bower, G., MacPredictions, "iPod Tablet [Mockup]," (<http://www.macpredictions.com/2009/04/ipod-tablet-mockup.html>), published Apr. 18, 2009, 8 pages.
- Bray, "LG Optimus Pad review: first look," PCPro.com, (<http://www.pcpro.co.uk/blogs/2011/02/14/lg-optimus-pad-review-first-look/>), published Feb. 14, 2011, 3 pages.
- Cashmore, P., Mashable, "Apple Tablet: Ultimate Gallery of Concept Designs and Prototypes," (<http://mashable.com/2009/08/07/apple-tablet-gallery/>), published Aug. 7, 2009, 28 pages.
- Cell phones.About.com, "More pictures of the LG KG800," (http://cellphones.about.com/library/bl-pi-lg_kg800.htm), accessed Feb. 13, 2012, 1 page.
- Cesweb, "MPIO," (http://www.cesweb.org/shared_files/innovations/innovations_2003/1616/mainphoto1616.jpg), retrieved Feb. 24, 2012, 1 page.
- Chi-atheneum, "Good Design 2003, An International Industrial and Graphic Design Competition," (<http://www.chi-atheneum.org/gdesign/winners03.htm>), retrieved Sep. 23, 2011, 7 pages.
- Chip Online, "VIA: Zwitter-PC für Schöngesteier," (http://www.chip.de/ii/202812385_78f68afa8e.jpg), published May 8, 2002, 1 page.
- Chip Online, "VIA: Zwitter-PC für Schöngesteier," (http://www.chip.de/news/VIA-Zwitter-PC-fuer-Schoengeister_34204096.html), published May 8, 2002, 3 pages.
- Chubb, Daniel, Amtek's iTablet T221: new to the tablet and UMPC scene, 4 pages, <http://www.product-reviews.net/2008/01/11/amteks-itablt-t221-new-to-thetablet-and-umpc-scene/>, Jan. 11, 2008.
- Clarke, "Newspad by Authur C. Clarke from 2001: A Space Odyssey," (<http://www.technovelgy.com/ct/content.asp?Bnum=529>), published 1968, 3 pages.
- Cnet, "HP Compaq Tablet PC TC1000 Review," http://reviews.cnet.com/tablet-pcs/hp-compaq-tablet-pc/4505-3126_7-20627295.html, published Nov. 6, 2002, 8 pages.
- Cnet, "Sony Clie," (<http://reviews.cnet.com/sc/30733801-2-440-overview-1.gif>), retrieved Feb. 26, 2012, 1 page.
- Coldeway, Devin, TechCrunch Tablet makes an early debut, 26 pages, <http://www.crunchgear.com/2009/04/09/crunchtablet-hits-the-net-a-little-early/>, Apr. 9, 2009.
- Computer Museum, "Toshiba Dynapad T100X (1992)," <http://www.computermuseum.li/Testpage/Toshiba-Dynapad-1992.htm>, product announced Nov. 1992, 1 page.
- ComputerWeekly.com, "Why the Blackberry Playbook is for enterprise users," (<http://www.computerweekly.com/news/1280097215/Why-the-Blackberry-Playbook-is-for-enterprise-users>), published Sep. 28, 2010, 1 page.

- Computex.biz, "Tatung Tablet PC," (http://www.computex.biz/tatung/Default.aspx?pagetype=ProductDetail&pdt_id=36&cid=3...), accessed Nov. 4, 2011, 3 pages.
- Computing History, "GRidPad 1910," (<http://computinghistory.org.uk/det/6565/GRidPad-1910>), retrieved Sep. 12, 2011, 2 pages.
- Davies, Chris, Are Dell planning a keyboard-less UMPC?, 15 pages, <http://www.slashgear.com/are-dell-planning-a-keyboard-less-umpc-096130/>, Jul. 9, 2007.
- De Herrera, C., tabletpctalk, "Tatung Tablet PC Picture," (<http://www.tabletpctalk.com/pictures/tatung.shtml>), 2003, 3 pages.
- Dg2000, Flickr, "Sony CLIE PEG-TH55/E1," (<http://www.flickr.com/photos/derekwilkinson/1323901259/>), photo taken Sep. 4, 2007, 2 pages.
- Digibarn Computer Museum, "Image of the GO tablet," (<http://www.digibarn.com/collections/systems/go/DSC02917.JPG>), retrieved Feb. 24, 2012, 1 page.
- Digibarn Computer Museum, "Image of the GO tablet," (<http://www.digibarn.com/collections/systems/go/DSC02942.JPG>), retrieved Feb. 24, 2012, 1 page.
- Digibarn Computer Museum, "PenPoint tablet pen computer by GO Corporation," (<http://www.digibarn.com/collections/systems/go/index.html>), retrieved Jul. 18, 2011, 6 pages.
- DigiBarn Systems, "GRiDpad Pen Computer," (<http://www.digibarn.com/collections/systems/gridpad/index.html>), retrieved Sep. 23, 2011, 2 pages.
- Dunn, Jason, Ultra-Portable Concept PC Shown at WinHEC 2005, 1 page, <http://www.digitalhomethoughts.com/news/show/27459/ultra-portable-concept-pc-shown-at-winhec-2005.html>, Apr. 26, 2005.
- Edible Apple, "The first Apple Tablet . . . from 1979," (<http://www.edibleapple.com/the-first-apple-tablet-from-1979/>), published Nov. 23, 2009, 8 pages.
- Electricpig, "IFA 2010: Toshiba booth tour—Folio 100, Jacob Jensen and a few extra treats," Electricpig.co.uk, (<http://www.electricpig.co.uk/2010/09/03/ifa-2010-toshiba-booth-tour-folio-100-jacob-jensen-and-a-few-extra-treats/ifa-2010-toshiba-booth-tour-8/>), published Sep. 3, 2010, 1 page.
- Electronista, "LG/Prada phone revealed?," (<http://www.electronista.com/articles/06/12/20/lg.prada.phone.revealed/>), updated Dec. 20, 2006, 9 pages.
- Electrovaya, "Electrovaya Launches Scribbler® SC4000 Series Tablet PC," Jan. 9, 2008, 2 pages.
- EngineerBoy, CleverDonkey.com, "2001: A Space Odyssey and the iPad (or is it tamPod?)," (<http://www.cleverdonkey.com/1499-2001a-space-odyssey-and-the-ipad-or-is-it-tampod/>), published Feb. 2, 2010, 5 pages.
- Falcone, J., Cnet, "Digitalway MPIO-FL100 (128 MB)," (http://reviews.cnet.com/mp3-players/digitalway-mpio-fl100-128/4505-6490_7-20763548.html), published Apr. 18, 2003, 8 pages.
- Fidler, "Mediamorphosis: Understanding New Media," pp. 220, 222-225, and 236-242, Pine Forge Press, Thousand Oaks, CA (1997).
- Fidler, "Predicting e-readers in 1981: A look back at the future," Associated Press Managing Editors, (<http://www.snd.org/2010/01/predicting-e-readers-in-1981-a-look-back-at-the-future/>) published Jan. 14, 2010, 5 pages.
- Flatley, "BoEye MID700 unveiled with Android OS, vaguely familiar form factor," Engadget.com, (http://engadget.com/2009/11/11/boeye-mid700-unveiled-with-android-os-vaguely-familiar-form-fac/?icid=eng_Dubai_art), published Nov. 11, 2009, 2 pages.
- Flickr.com, "Apple Graphics Tablet" (http://farm3.static.flickr.com/2691/4126733086_b24c987b0e_o.jpg), accessed Nov. 15, 2011, 1 page.
- Focus Online, "Rollei DF8 DVB-T," (http://www.focus.de/digital/foto/rollei-df8-dvb-t-fernsehen-im-bilderrahmen__did_27152.html), published Feb. 18, 2010, 3 pages.
- Foto-Branche.de, "Kodak EasyShare S730: Digitaler Bilderrahmen mit integrierter Akku," (<http://www.foto-branche.de/news/singleview/browse/2/article/kodak-easyshare-s730-digitaler-bilderrahmen-mit-integrierter-akku/2.html>), published Jul. 13, 2009, 2 pages.
- Fotofabrikas, "AgfaPhoto AF 5087 MS 8," (http://www.fotofabrikas.lt/data/images/catalog_pics/n_preview/Skaitmeniniai%20remeliai%20AgfaPhoto%20AF%20587%20MS%208%20skaitmeninis%20r%20melis_01.jpg), retrieved Nov. 22, 2011, 1 page.
- Fotofabrikas, "AgfaPhoto AF 5087 MS 8," (<http://www.fotofabrikas.lt/en/items/Digital-Frames/Digital-photo-frames/2636ee4.2-AgfaPhoto-AF-5087-MS-8.html>), retrieved Nov. 21, 2011, 5 pages.
- Fried, "Live-blogging Steve Ballmer," CNET, (http://www.cnet.com/8301-31045_1-10426723-269.html?tag=mncol%3btxt), published Jan. 6, 2010, 6 pages.
- Funamizu, M., Petitinvention, "(iPod Touch + iMac + Macbook Air)/3," (<http://petitinvention.wordpress.com/2008/05/03/ipod-touch-imac-macbook-air-3/>), published May 3, 2008, 4 pages.
- GadgetFolder, "iRex Digital Reader 800 with 8-inch touchscreen and wireless," (<http://www.gadgetfolder.com/irex-digital-reader-800-with-8-inch-touchscreen-and-wireless.html>), published Aug. 9, 2009, 5 pages.
- Ganapati, "Hands On With the JooJoo, Formerly Known as CrunchPad," (<http://www.wired.com/gadgetlab/2009/12/hands-on-joo-joo-crunchpad/all/1>), published Dec. 7, 2009, 3 pages.
- Gilder, G. "Digital Dark Horse—Newspapers," Forbes ASAP, published Oct. 25, 1993, 2 pages.
- Gizmodo, "Kurztest: JooJoo (Crunchpad)—riesiges Internet-Tablet," (<http://www.gizmodo.de/2009/12/09/kurztest-joojoo-crunchpad-riesiges-internet-tablet.html>), retrieved Sep. 26, 2011, 13 pages.
- Gollwitzer, M., et al., Chip Online, "Microsofts CeBIT-Neuheiten 2002," (http://www.chip.de/artikel/c_druckansicht_9668117.html), published Mar. 13, 2002, 5 pages.
- Goss, "ViewSonic ViewPad 100 with Windows and Android shown," TechRadar.com, (<http://www.techradar.com/news/mobile-computing/viewsonic-viewpad-100-with-windows-and-android-shown-714182>), published Sep. 3, 2010, 2 pages.
- Grabham, "Hands on: Toshiba Folio 100 review," TechRadar.com, (<http://www.techradar.com/news/mobile-computing/tablets/hands-on-toshiba-folio-100-review-714014>), published Sep. 2, 2010, 4 pages.
- Grabham, "Hands on: Viewsonic ViewPad 10 review," TechRadar.com, (<http://www.techradar.com/news/mobile-computing/tablets/hand-on-viewsonic-viewpad-10-review-714205>), published Sep. 3, 2010, 3 pages.
- Hagen, R., GadgetZone, "iHolic portable mediaspeler," (<http://www.gadgetzone.nl/nieuws.php?id=3191>), published Jan. 4, 2007, 3 pages.
- Heimi, "MPIO," (<http://www.heimi.net/FlashPlayer/MPIOFL100/pics/01a%20FL100Backlight.jpg>), retrieved Feb. 24, 2012, 1 page.
- Heimkino Markt, "CeBIT 2004 News: FLATRON Tablet—TFT-Monitor von LG mit Stifteingabemöglichkeit / Ideal für Industrie- und Designanwendungen," (<http://www.heimkinomarkt.de/News/643/LG/CeBIT%202004%20News%20FLATRON%20TabletTFT%20Monitor%20von/>), published Mar. 25, 2004, 3 pages.
- Henderson, "LG Optimus Pad to take on Samsung and Apple," Pocket-lint.com, (<http://www.pocket-lint.com/news/35287/lg-optimus-pad-samsung-apple>), published Aug. 31, 2010, 1 page.
- HP Compaq Tablet PC TC1000, <http://www.hardwarezone.com.au/reviews/view.php?cid=45&id=533&pg=2>. Downloaded Apr. 20, 2010, 1 page.
- HP Compaq Tablet PC TC1000, <http://www.tc-one-thousand.com>. Downloaded Apr. 20, 2010, 2 pages.
- HP Compaq Tablet PC TC1000-TM5800 1GHz-10.4" TFT, CNET Reviews, http://reviews.cnet.com/tablet-pcs/hp-compaq-tablet-pc/4505-1707_7-20627295.html. Downloaded Apr. 20, 2010, 13 pages.
- Itbusiness.ca, "Microsoft Mira eHome Wireless Smart Display," (http://www.itbusiness.ca/images/articles/Jun10/clip_image003_0087.jpg), accessed Nov. 15, 2011, 1 page.
- iTechNews.net, "Samsung K3 MP3 Player," (<http://www.itechnews.net/2006/12/02/samsung-k3-mp3-player/>), published Dec. 2, 2006, 9 pages.
- Jarrett, R. et al., Building Tablet PC Applications, pp. 38, Microsoft Press, Redmond, Washington, (2003).
- JKKMobile.com, "Hanvon TouchPad BC10C tablet review," (<http://www.ikkmobile.com/2010/03/hanvon-touchpad-bc10c-tablet-review.html>), published Mar. 13, 2010, 2 pages.

- Justia, “*Apple v. Samsung Electronics Co. Ltd. et al.*, Filing: 427 Attachment: 42,” (<http://docs.justia.com/cases/federal/district-courts/california/candce/5:2011cv01846/239768/427/42.html>), dated Nov. 28, 2011, 3 pages.
- Justia, “*Apple v. Samsung Electronics Co. Ltd. et al.*, Filing: 427 Attachment: 43,” (<http://docs.justia.com/cases/federal/district-courts/california/candce/5:2011cv01846/239768/427/43.html>), dated Nov. 28, 2011, 3 pages.
- Justia, “*Apple v. Samsung Electronics Co. Ltd. et al.*, Filing: 427 Attachment: 44,” (<http://docs.justia.com/cases/federal/district-courts/california/candce/5:2011cv01846/239768/427/44.html>), dated Nov. 28, 2011, 3 pages.
- Justia, “*Apple v. Samsung Electronics Co. Ltd. et al.*, Filing: 166 Attachment: 10,” (<http://docs.justia.com/cases/federal/district-courts/california/candce/5:2011cv01846/239768/166/10.html>), dated Aug. 22, 2011, 2 pages.
- Justia, “*Apple v. Samsung Electronics Co. Ltd. et al.*, Filing: 166 Attachment: 11,” (<http://docs.justia.com/cases/federal/district-courts/california/candce/5:2011cv01846/239768/166/11.html>), dated Aug. 22, 2011, 2 pages.
- Justia, “*Apple v. Samsung Electronics Co. Ltd. et al.*, Filing: 166 Attachment: 14,” (<http://docs.justia.com/cases/federal/district-courts/california/candce/5:2011cv01846/239768/166/14.html>), dated Aug. 22, 2011, 2 pages.
- Justia, “*Apple v. Samsung Electronics Co. Ltd. et al.*, Filing: 166 Attachment: 15,” (<http://docs.justia.com/cases/federal/district-courts/california/candce/5:2011cv01846/239768/166/15.html>), dated Aug. 22, 2011, 2 pages.
- Justia, “*Apple v. Samsung Electronics Co. Ltd. et al.*, Filing: 166 Attachment: 16,” (<http://docs.justia.com/cases/federal/district-courts/california/candce/5:2011cv01846/239768/166/16.html>), dated Aug. 22, 2011, 2 pages.
- Justia, “*Apple v. Samsung Electronics Co. Ltd. et al.*, Filing: 166 Attachment: 9,” (<http://docs.justia.com/cases/federal/district-courts/california/candce/5:2011cv01846/239768/166/9.html>), dated Aug. 22, 2011, 2 pages.
- Justia, “*Apple v. Samsung Electronics Co. Ltd. et al.*, Filing: 456 Attachment: 5,” (<http://docs.justia.com/cases/federal/district-courts/california/candce/5:2011cv01846/239768/456/5.html>), dated Dec. 7, 2011, 3 pages.
- Justia, “*Apple v. Samsung Electronics Co. Ltd. et al.*, Filing: 456 Attachment: 6,” (<http://docs.justia.com/cases/federal/district-courts/california/candce/5:2011cv01846/239768/456/6.html>), dated Dec. 7, 2011, 3 pages.
- Justia, “*Apple v. Samsung Electronics Co. Ltd. et al.*, Filing: 456 Attachment: 7,” (<http://docs.justia.com/cases/federal/district-courts/california/candce/5:2011cv01846/239768/456/7.html>), dated Dec. 7, 2011, 3 pages.
- Justia, “*Apple v. Samsung Electronics Co. Ltd. et al.*, Filing: 166 Attachment: 2,” (<http://docs.justia.com/cases/federal/district-courts/california/candce/5:2011cv01846/239768/166/2.html>), dated Aug. 22, 2011.
- Justia, “*Apple v. Samsung Electronics Co. Ltd. et al.*, Filing: 166 Attachment: 3,” (<http://docs.justia.com/cases/federal/district-courts/california/candce/5:2011cv01846/239768/166/3.html>), dated Aug. 22, 2011.
- Justia, “*Apple v. Samsung Electronics Co. Ltd. et al.*, Filing: 166 Attachment: 4,” (<http://docs.justia.com/cases/federal/district-courts/california/candce/5:2011cv01846/239768/166/4.html>), dated Aug. 22, 2011.
- Justia, “*Apple v. Samsung Electronics Co. Ltd. et al.*, Filing: 943 Attachment: 5,” (<http://docs.justia.com/cases/federal/district-courts/california/candce/5:2011cv01846/239768/943/5.html>), dated May 18, 2012, 3 pages.
- Kahney, L., Cult of Mac, “Mac Air Tablet Mockup From Isamu Sanada,” (<http://www.cultofmac.com/1952/mac-air-tablet-mockup-from-isamu-sanada/>), published May 6, 2008, 13 pages.
- Kahney, L., Wired, “Apple’s Newton Just Won’t Drop,” (<http://www.wired.com/gadgets/mac/commentary/cultofmac/2002/08/54580>), published Aug. 29, 2002, 2 pages.
- KingVision, “Digital Photo Frame,” (http://www.sz-kingvision.com/product.php?type_id=1&weblan=e), retrieved Nov. 21, 2011, 2 pages.
- KingVision, “DPF-1902,” (http://www.sz-kingvision.com/product_disp.php?productid=24&weblan=e), retrieved Nov. 21, 2011, 3 pages.
- Knowyourmobile.com, “LG KG800 technical specifications,” (http://www.knowyourmobile.com/lg/lgkg800chocolate/lgkg800reviews/137/lg_kg800_technical_specifications.html), published Mar. 9, 2007, 3 pages.
- Kowalski, M., “Review: Kodak EasyShare S730,” Digital Picture Frame Review, (<http://www.digitalpictureframereview.com/2009/07/review-kodak-easyshre-s730>), published Jul. 17, 2009, 14 pages.
- Lazar, L., Cult of Mac, “Mac Pad Mock Up,” (<http://www.cultofmac.com/4921/mac-pad-mock-up/>), published Nov. 19, 2008, 12 pages.
- Leachon, “IFA 2010: Toshiba’s FOLIO 100 Tablet has Android, Flash and nice price tag,” ShinyShiny.tv, (http://www.shinyshiny.tv/2010/09/ifa_2010_toshiba_folio_100.html), published Sep. 2, 2010, 2 pages.
- Lerg, Andreas, Billig-Tablet-Computer vom Grabbeltisch, 2 pages, http://digitalleben.t-online.de/tablet-pc-von-jay-tech-fuer-140-euro-bei-rossmann/id_43326132/index, Nov. 3, 2010.
- Long, B., Macworld, “PL500 LCD Pen Tablet System,” (<http://images.macworld.com/images/legacy/2001/02/images/content/wacom.gif>), published Feb. 1, 2001, 1 page.
- Long, B., Macworld, “PL500 LCD Pen Tablet System,” (<http://www.macworld.com/article/1938/2001/02/wacomtablet.html>), published Feb. 1, 2001, 1 page.
- Loyola, Roman, Macworld Video: Axiotron Modbook Pro first look, 4 pages, <http://www.macworld.com/article/137878/2009/01/mwvodcast86.html>, Jan. 5-9, 2009.
- Markoff, J., “A Media Pioneer’s Quest: Portable Electronic Newspapers,” The New York Times, published Jun. 28, 1992, p. 11.
- Martin, T., “The Tablet Newspaper: A Vision for the Future,” Human Factors in Computing Systems, Chi ’95 Conference Companion, pp. 425, Colorado, United States (May 1995).
- McCracken, “The iPad. Of 2000. As Envisioned in 1988,” Technologizer.com, (<http://technologizer.com/2010/05/14/the-ipad-of-2000-as-envisioned-in-1988/>), published May 14, 2010, 12 pages.
- Mel et al., “Tablet: Personal Computer in the Year 2000,” *Communications of the ACM* 31:638-646, ACM (Jun. 1988).
- Microsoft, “Bill Gates Highlights the Magic of Consumer Software And the Coming Digital Decade at Consumer Electronics Show,” (<http://www.microsoft.com/presspass/press/2002/jan02/01-07ces2002keynotepr.mspx>), published Jan. 7, 2002, 3 pages.
- Miles, “56 Apple iTablet concept designs: Could any be real?,” (<http://www.pocket-lint.com/news/26500/56-apple-itablenet-concept-designs>), published Aug. 21, 2009, 14 pages.
- Miles, “BlackBerry PlayBook: RIM launches tablet,” Pocket-lint.com, (<http://www.pocket-lint.com/news/35893/rim-blackberry-playbook-tablet-device>), published Sep. 27, 2010, 8 pages.
- Miller, “MSI shows off 10-inch Android tablet running new Tegra chipset,” Engadget.com, (<http://www.engadget.com/2010/01/08/msi-shows-off-10-inch-android-tablet-running-new-tegra-chipset/>), published Jan. 8, 2010, 11 pages.
- Mobilegazette.com, “Nokia N92,” (<http://www.mobilegazette.com/nokia-n92-051102.htm>), published Nov. 2, 2005, 2 pages.
- Monitor4u, “Flatron L1530TM,” (<http://www.monitor4u.co.kr/review/review4u/content.asp?idx=580&leftcode=16>), published Mar. 17, 2004, 7 pages.
- My Burmese Blog, “Apple Touch Screen Netbook Prototypes Hit The Web,” (<http://www.htootayzar.com/myblog/2009/03/apple-touch-screen-netbook-prototypes-hit-the-web/>), published Mar. 12, 2009, 10 pages.
- Needleman, “Hands-on with the JooJoo,” (http://news.cnet.com/8301-19882_3-10410960-250.html), CNET News, published Dec. 7, 2009, 31 pages.
- Netzwelt, “Rollei DF8 DVB-T,” (<http://www.netzwelt.de/news/81537-rollei-df8-dvb-t-test-digitaler-bilderrahmen-mini-fernseher.html>), retrieved Nov. 21, 2011, 10 pages.
- Newgadgets.de, Mysteriöser Tablet-PC?, 6 pages, <http://www.newgadgets.de/6072/mysteriöser-tablet-pc/>, Nov. 10, 2009.
- NewLaunches, “LG Prada cell phones are truly iconic,” (http://www.newlaunches.com/archives/lg_prada_cell_phones_are_truly_iconic.php), retrieved Sep. 12, 2011, 3 pages.

- NewLaunches, "LG Wears Prada," (http://www.newlaunches.com/archives/lg_wears_prada.php), retrieved Sep. 23, 2011, 2 pages.
- Newlaunches.com, "PIDION BM-200 sleek Windows CE PDA phone from Bluebird," (http://www.newlaunches.com/archives/pidion_bm200_sleek_windows_ce_pda_phone_from_bluebird.php), published Dec. 15, 2005, 3 pages.
- Nguyen, "Hannspree's Hannspad Tablet Runs Android 2.2 with Custom UI," Ubergizmo.com, (<http://www.ubergizmo.com/2010/11/hannsprees-hannspad-tablet-runs-android-2-2-with-custom-ui/>), published Nov. 18, 2010, 1 page.
- NotebookCheck, "Fujitsu-Siemens Stylistic ST5022," (<http://www.notebookcheck.com/typo3temp/pics/d675d29c1f.jpg>), retrieved Sep. 26, 2011, 1 page.
- NYTimes.com, "iRiver U10 (1GB)," (<http://www.nytimes.com/technology/personaltech/music-players/iRiver-U10-1GB-/31432102.html>), published Feb. 12, 2012, 2 pages.
- NYTimes.com, "iRiver U10 (1GB)," (<http://www.nytimes.com/technology/personaltech/music-players/iRiver-U10-1GB-/31432102.html>), published Feb. 12, 2012, 2 pages.
- Old Computers, "Toshiba T100-X Dynapad," (<http://www.old-computers.com/museum/computer.asp?st=1&c=801>), product released 1993, 2 pages.
- Oullette, D., "Dynapad weighs in at just 3.3 pound," Info World, vol. 15, Issue 31, Aug. 2, 1993, 2 pages.
- Patel, "The HP Slate" (<http://www.engadget.com/2010/01/06/the-hp-slate/>), Engadget.com, published Jan. 6, 2010, 4 pages.
- PC Magazine, "HP Compaq Tablet PC TC1000," (<http://www.pcmag.com/article2/0,2817%20,939500,00.asp>), published Apr. 8, 2003, 3 pages.
- PDA Museum, "Sony Clie," (http://www.pdamuseum.com/sony_clie/clie_pics/th-55j2.jpg), retrieved Feb. 26, 2012, 1 page.
- PDADB.net, "Acer n20 Specs," (<http://pdadb.net/index.php?m=specs&id=257&c=acern20>), published May 13, 2005, 3 pages.
- PDADB.net, "Casio Cassiopeia IT-10 M20BR Specs," (http://pdadb.net/index.php?m=specs&id=95&c=casio_cassiopeia_it-10_m20br), published Dec. 30, 2004, 3 pages.
- PDADB.net, "Dell Axim X3 Basic Specs," (http://pdadb.net/index.php?m=specs&id=81&c=dell_axim_x3_basic), published Dec. 30, 2004, 3 pages.
- PDADB.net, "MiTAC Mio 338 Plus Digi-Walker Specs," (http://pdadb.net/index.php?m=specs&id=60&c=mitac_mio_338_plus_digi-walker), published Dec. 25, 2004, 3 pages.
- PDADB.net, "O2 XDA (HTC Wallaby) Specs," (http://pdadb.net/index.php?m=specs&id=117&c=o2_xda_htc_wallaby), published Feb. 3, 2005, 3 pages.
- PDADB.net, "Sony Clie PEG-SL10 / PEG-SL10U / PEG-SL10E Specs," (http://pdadb.net/index.php?m=specs&id=1198&c=sony_clie_peg-s110_peg-S110u_peg-s110e), published Mar. 4, 2008, 3 pages.
- PDADB.net, "Sony Clie PEG-T665C / PEG-T675C Specs," (http://pdadb.net/index.php?m=specs&id=1192&c=sony_clie_peg-t665c_peg-t675c), published Mar. 4, 2008, 3 pages.
- PDADB.net, "Toshiba Genio e330 Specs," (http://pdadb.net/index.php?rn=specs&id=29&c=toshiba_genio_e330), published Dec. 9, 2004, 3 pages.
- PDADB.net, "Toshiba Genio e570 Specs," (http://pdadb.net/index.php?m=specs&id=229&c=toshiba_genio_e570), published May 4, 2006, 3 pages.
- Perton, "Samsung digital picture frame stores pics, movies, music," Engadget, (<http://www.engadget.com/2006/03/09/samsung-digital-picture-frame-stores-pics-movies-music/>), published Mar. 9, 2006, 1 page.
- Presstime, "Life After Viewtron? Enter the E-Paper," Presstime, published Aug. 1993, p. 18-19.
- Radioshack, Motorola DEFY with MOTOBLUR Black, 1 page, http://radioshackwireless.com/eCommerce/SpecialOffer.aspx?cid=25578_47f08265355e4a8a92dcd57eed6cbc69.
- Receipt of an Invalidity Application Notification to the Holder of the Contested RCD, Community Design No. 001222905-0002, File No. ICD 8453, 1 page, mailed May 23, 2011.
- Request for declaration of invalidity of design No. 001222905-0002, 6 pages, May 5, 2011.
- Request for Re-examination of Australian Design Registration Nos. 337931, 337833, 337832, 3 pages.
- Ricker, "LG's KE850 PRADA official: iPhone says, wha?" Engadget.com, (<http://www.engadget.com/2007/01/18/lgs-ke850-prada-official-iphone-says-wha/>), published Jan. 18, 2007, 4 pages.
- Ricker, "The Pidion BM-200: It's time to move to Seoul," (<http://www.engadget.com/2005/10/04/the-pidion-bm-200-its-time-to-move-to-seoul/>), Engadget.com, published Oct. 4, 2005, 4 pages.
- Rojas, "Hands-on with the Nokia N92," Engadget.com, (<http://www.engadget.com/2005/12/01/hands-on-with-the-nokia-n92/>), published Dec. 1, 2005, 4 pages.
- Rothman, W., Gizmodo, "HP's Windows 7 Slate Device Revealed by Steve Ballmer," (<http://gizmodo.com/5442200/hps-windows-7-slate-device-revealed-by-steve-ballmer>), published Jan. 6, 2010, 8 pages.
- S. Dimitris, "Pidion BM200 Smartphone," PDASNews, (www.pdasnews.com/articles/pidion-bm200-smartphone.html), accessed Mar. 7, 2012, 2 pages.
- Salestores.com, "LG L1530TM Tablet LCD Monitor," (<http://salestores.com/lg11talcdmos.html>), accessed Nov. 17, 2011, 2 pages.
- Samsung, "Samsung F700 is razendsnelle alleskunner voor mobiel breedband van Vodafone," (http://www.samsung.com/nl/mobile/pressView.do?ptype=press&page=13&news_seq=22544), published May 25, 2008, 2 pages.
- Samsung, "Samsung Introduces Ultra Thin Touch of Color Photo Frame," (http://www.samsung.com/us/news/newsPreviewRead.do?news_seq=13462), published May 23, 2009, 2 pages.
- Samsung, "Samsung Unveils Revolutionary Ultra Smart F700," (http://www.samsung.com/us/news/newsRead.do?news_seq=3516), published Nov. 23, 2009, 2 pages.
- Samsung, "Samsung's Digital Photo Frames," (http://www.samsung.com/hk_en/consumer/detail/productPreviewRead.do?model_cd=LP08IPLSB/XK&group=photography&type=photo-frame&subtype=photo-frame), retrieved Nov. 21, 2011, 4 pages.
- Sandeep, "LG Optimus Pad with Honeycomb Launching at MWC 2011," Fonearena.com, (<http://www.fonearena.com/blog/30270/lg-optimus-pad-with-honeycomb-launching-at-mwc-2011.html>), published Feb. 4, 2011, 1 page.
- Savov, "LG Pad coming in Q1 2011, with Android Honeycomb, dual-core Tegra 2, and 8.9-inch screen," Engadget.com, (<http://www.engadget.com/2010/11/03/lg-pad-coming-in-early-2011-with-android-honeycomb-dual-core-t/>), published Nov. 3, 2010, 1 page.
- Savov, V., Engadget, "NVIDIA Tegra tablet prototype hands-on," (<http://www.engadget.com/2009/11/27/nvidia-tegra-tablet-prototype-hands-on/>), published Nov. 27, 2009, 5 pages.
- Savov, V., Engadget, "NVIDIA Tegra tablet prototype hands-on," (<http://www.engadget.com/photos/nvidia-tegra-tablet-prototype/#2485983>), published Nov. 27, 2009, 2 pages.
- Savov, V., Engadget, "NVIDIA Tegra tablet prototype hands-on," (<http://www.engadget.com/photos/nvidia-tegra-tablet-prototype/#2485984>), published Nov. 27, 2009, 2 pages.
- Savov, V., Engadget, "NVIDIA Tegra tablet prototype hands-on," (<http://www.engadget.com/photos/nvidia-tegra-tablet-prototype/#2485985>), published Nov. 27, 2009, 2 pages.
- Savov, V., Engadget, "NVIDIA Tegra tablet prototype hands-on," (<http://www.engadget.com/photos/nvidia-tegra-tablet-prototype/#2485986>), published Nov. 27, 2009, 2 pages.
- Savov, V., Engadget, "NVIDIA Tegra tablet prototype hands-on," (<http://www.engadget.com/photos/nvidia-tegra-tablet-prototype/#2485987>), published Nov. 27, 2009, 2 pages.
- Savov, V., Engadget, "NVIDIA Tegra tablet prototype hands-on," (<http://www.engadget.com/photos/nvidia-tegra-tablet-prototype/#2485988>), published Nov. 27, 2009, 2 pages.
- Savov, V., Engadget, "NVIDIA Tegra tablet prototype hands-on," (<http://www.engadget.com/photos/nvidia-tegra-tablet-prototype/#2485989>), published Nov. 27, 2009, 2 pages.
- Savov, V., Engadget, "NVIDIA Tegra tablet prototype hands-on," (<http://www.engadget.com/photos/nvidia-tegra-tablet-prototype/#2485990>), published Nov. 27, 2009, 2 pages.
- Savov, V., Engadget, "NVIDIA Tegra tablet prototype hands-on," (<http://www.engadget.com/photos/nvidia-tegra-tablet-prototype/#2485991>), published Nov. 27, 2009, 2 pages.

- Savov, V., Engadget, "NVIDIA Tegra tablet prototype hands-on," (<http://www.engadget.com/photos/nvidia-tegra-tablet-prototype/#2485992>), published Nov. 27, 2009, 2 pages.
- Schulze, S. and Gratz, I., "1999 | Studio Display," in Apple Design, pp. 144-145, Hatje Cantz Verlag, Ostfildern, Germany (2011).
- Scott, "LG Announces LG Optimus Pad at Dealer Days in Brussels," Netbooknews.com, (<http://www.netbooknews.com/7518/lg-announces-lg-optimus-pad-at-dealer-days-in-brussels/>), published Aug. 31, 2010, 4 pages.
- Scott, "Motorola Xoom Android 3.0 Tablet Goes Official," Netbooknews.com, (<http://www.netbooknews.com/17229/motorola-xoom-android-3-0-tablet-goes-official/>), published Jan. 6, 2011, 6 pages.
- Scrapin_frame, s10forum, "fs: 2 lg flatron tablet monitors," (<http://www.s10forum.com/forum/f296/fs-2-lg-flatron-tablet-monitors-483210/>), published Nov. 27, 2011, 5 pages.
- Shanghaiist.com "ZOMG! Maker of Chinese iPad clone P88 to sue Apple for cloning its tablet!," <<http://shanghaiist.com/2010/01/29/p88-chinese-ipad-clone-sues-apple.php>>, Jan. 29, 2010, 5 pages.
- Sierra, Amtek Releases the iTablet T221 Tablet PC, Laptops Arena, 5 pages, <http://www.laptopsarena.com/amtek-releases-the-itablet-t221-tablet-pc/>, Dec. 22, 2007.
- Smith, C., HuffPost Tech, "History of Tablet PCs (Photos): A Pictorial Timeline of Tablets, From RAND To The iPad," (http://www.huffingtonpost.com/2010/04/15/history-tablet-pc-photos_n_538806.html), published Apr. 15, 2010, 5 pages.
- Smith, T., RegHardware.com, "First fondleslab found in 1970s kids TV sci-fi gem," (http://www.reghardware.com/2011/02/07/apple_ipad_tomorrow_people/print.html), published Feb. 7, 2011, 3 pages.
- Softgate, "Fujifilm FinePix Real 3D V1," (http://www.softgate.ch/ger_details_31383/Fujifilm_FinePix_Real_3D_V1_Viewer_8_TFT.html), published Apr. 16, 2010, 2 pages.
- Sony, "The Sony CliéPEG-TH55 heralds The Next Generation Of Digital Organisers," (<http://dpnow.com/595.html>), published Feb. 13, 2004, 2 pages.
- Stevens, "ICD confirms Vega tablet, includes Android 2.0, Tegra processor, our hearts," Engadget.com, (<http://www.engadget.com/2009/11/13/icd-confirms-vega-tablet-includes-android-2-0-tegra-processor/>), published Nov. 13, 2009, 2 pages.
- Stromer, G., "CES 2010: Plastic Logic zeigt superflachen und -teuren eBook-Reader Que," (<http://www.cnet.de/41525409/ces-2010-plastic-logic-zeigt-superflachen-und-teuren-ebook-reader-que/>), published Jan. 10, 2010, 2 pages.
- Sung, "Motorola Xoom vs. Apple iPad," Pocket-lint.com, (<http://www.pocket-lint.com/news/37732/motorola-xoom-vs-apple-ipad/>), published Jan. 6, 2011, 3 pages.
- Sze, Amtek has five iTablets for the Computex 2010, iTech News Net, 13 pages, <http://www.itechnews.net/2010/05/27/amtek-has-five-itables-for-the-computex-2010/>.
- Tatung, "Comdex Fall 2003 Tatung Booth# 10248," (<http://www.tatung.com/en/news/comdex2003.htm>), published Nov. 17, 2003, 2 pages.
- TechLahore.com, "China's Boeye releases "Apple tablet" before Apple can—TechLahore@GITEX," (<http://www.techlahore.com/2009/11/08/chinas-boeye-releases-apple-tablet-before-apple-can-techlahoregitex/>), published Nov. 8, 2009, 3 pages.
- Testberichte.de, "Fuji FinePix REAL 3D V1," (<http://www.testberichte.de/p/philips-tests/digital-photoframe-sph8008-testbericht.html>), retrieved Nov. 21, 2011, 3 pages.
- Testberichte.de, "Philips Digital PhotoFrame SPH8008," (<http://www.testberichte.de/p/philips-tests/digital-photoframe-sph8008-testbericht.html>), retrieved Nov. 21, 2011, 4 pages.
- The Apple Collection, "Apple PowerPad G3 Pro—Apple Design & Prototype," (www.theapplecollection.com/design/macdesign/Apple_PowerPad_G3_Pro.shtml), updated Oct. 31, 2011, 2 pages.
- The Apple Collection, "MyPal," (www.theapplecollection.com/design/macdesign/MyPal.shtml), updated Oct. 31, 2011, 2 pages.
- The Apple Collection, "PowerPad," (www.theapplecollection.com/design/macdesign/PowerPad2.shtml), updated Oct. 31, 2011, 2 pages.
- The Internet Movie Database, "The Tomorrow People," (<http://www.imdb.com/title/tt0069647/>), retrieved Oct. 11, 2011, 5 pages.
- Tingle, "ICD Vega Android 2.0 Tablet Available in 2010 [Vega Android Tablet, Nvidia Tegra Chipset Touting 'Low Cost Tablet' Confirmed]," (<http://nexus404.com/Blog/2009/11/13/icd-vega-android-2-0-tablet-available-in-2010-vega-android-tablet-nvidia-tegra-chipset-touting-low-cost-tablet-confirmed/>), TFTS, published Nov. 13, 2009, 2 pages.
- To, "Boeye MID 700 tablet runs android with Apple-esque-aesthetics," Pocketables.com, (<http://www.pocketables.net/2009/11/boeye-mid-700-tablet-runs-android-with-applesque.aesthetics.html>), published Nov. 12, 2009, 2 pages.
- Topolsky, "Leaked pics of the CrunchPad make it look dangerously close to availability," Engadget.com, (<http://www.engadget.com/2009/04/09/leaked-pics-of-the-crunchpad-make-it-look-dangerously-close-to-a/>), published Apr. 9, 2009, 2 pages.
- Topolsky, "NVIDIA CEO shows off mystery tablet, makes zero statements about mystery tablet," Engadget.com, (<http://www.engadget.com/2009/11/09/nvidia-ceo-shows-off-mystery-tablet-makes-zero-statements-about/>), published Nov. 9, 2009, 1 page.
- Topolsky, Joshua, Amtek intros the iTablet T221 UMPC, 3 pages, <http://www.engadget.com/2007/12/18/amtek-intros-the-itablet-t221-umpc/>, Dec. 18, 2007.
- Toshiba, "Dynapad T100X," product announced Nov. 1992, 2 pages.
- Touch User Guide, "What will the new Apple Tablet look like? Apple tablet images leaked?," (<http://www.touchuserguide.com/2009/07/29/what-will-the-new-apple-tablet-look-like/>), published Jul. 29, 2009, 29 pages.
- Toxel.com, "12 Cool Apple Tablet Concepts," (<http://www.toxel.com/tech/2009/08/12-cool-apple-tablet-concepts/>), published Aug. 31, 2009, 16 pages.
- Van Reeth, J., "Vantage is showing its colours!," *Home automation journal* 11:1-8, Vantage Emea, Belgium (Jun. 2003).
- Verkehrsrundschau, "Details zum Digitalen Bilderrahmen," (http://www.verkehrsrundschau.de/fotowettbewerb-mein-tag-der-logistik-835123.html?_apg=2), published Apr. 27, 2009, 1 page.
- Vilas-Boas, R., "Nokia I.D.," (<http://rdvb-designshowcase.blogspot.com/p/cheddar-1-2009.html>), retrieved Nov. 7, 2011, 6 pages.
- Wacom, "Company History, PL-500," (<http://wacom.jp/en/company/history/>), product released Jun. 2000, 1 page.
- WebdesignerDepot.com, "The Evolution of Cell Phone Design Between 1983-2009" (<http://www.webdesignerdepot.com/2009/05/the-evolution-of-cell-phone-design-between-1983-2009/>), accessed May 6, 2011, 56 pages.
- Weiss, "Hands-On: NVIDIA Tegra Tablet Prototyp ICD Vega (Video)," (<http://de.engadget.com/2009/11/28/hands-on-nvidia-tegra-tablet-prototyp-icd-vega-video/>), Engadget German, published Nov. 28, 2009, 13 pages.
- Wikimedia, "MPIO," (http://upload.wikimedia.org/wikipedia/commons/e/e9/M-Pio_FL100.jpg), retrieved Feb. 24, 2012, 1 page.
- Wikipedia, "Etch A Sketch," (http://en.wikipedia.org/wiki/Etch_a_sketch), last modified Aug. 24, 2011, 4 pages.
- Wikipedia, "MessagePad," (<http://en.wikipedia.org/wiki/Messagepad>), retrieved Sep. 12, 2011, 10 pages.
- Wikipedia, Axiotron Modbook, 4 pages, http://en.wikipedia.org/wiki/Axiotron_Modbook.
- Wikipedia, Datei:Modbook pro.jpg, 4 pages, http://de.wikipedia.org/wiki/Datei:Modbook_pro.jpg, Feb. 21, 2009.
- Wikipedia, Datei:VIA Tablet PC Reference Design.jpg, 3 pages, http://de.wikipedia.org/wiki/Datei:VIA_Tablet_PC_Reference_Design.jpg, Mar. 10, 2009.
- Wikipedia, Dynabook, 2 pages, <http://de.wikipedia.org/wiki/Dynabook>, last updated Apr. 2, 2011.
- Wikipedia, Tablet-Computer, 3 pages, <http://de.wikipedia.org/wiki/Tablet-Computer>, Apr. 7, 2011.
- Wikipedia, Tablet-PC, 2 pages, <http://de.wikipedia.org/wiki/Tablet-PC>, Apr. 14, 2011.
- Wikipedia.org, "CLIÉ," (<http://en.wikipedia.org/wiki/CLI%C3%89>), last modified Feb. 12, 2011, 3 pages.
- Wikipedia.org, "E-Ten" (<http://en.wikipedia.org/wiki/E-Ten>), last modified Dec. 15, 2010, 2 pages.
- Wikipedia.org, "File:LG KE850 Prada Hauptmenü.jpg," (http://en.wikipedia.org/wiki/File:LG_KE850_Prada_Hauptmen%C3%BC.jpg), accessed Feb. 12, 2012, 4 pages.

Wikipedia.org, "iPAQ" (<http://en.wikipedia.org/wiki/IPAQ>), last modified May 4, 2011, 7 pages.
 Wikipedia.org, "Pocket viewer," (http://en.wikipedia.org/wiki/Pocket_viewer), last modified Apr. 10, 2011, 4 pages.
 Wikipedia.org, "Zire Handheld" (http://en.wikipedia.org/wiki/Zire_Handheld), last modified Dec. 11, 2010, 4 pages.
 Wiley, M., IGN, "MPIO FL100 Review," (<http://uk.ign.com/articles/2003/01/21/mpio-fl100-review>), published Jan. 21, 2003, 4 pages.
 Yatego Shopping, "Lenco Digitaler Bilderrahmen DF-911 B," (<http://www.yatego.com/index.htm?cl=spotshopping&popup=media&pid=4a13d0ce891ff>), retrieved Nov. 21, 2011, 1 page.
 ZDNet, "Viewsonic V1100," (<http://www.zdnet.nl/reviews/24712/viewsonic-v1100/>), published Feb. 17, 2003, 9 pages.
 Ziegler, C., Engadget, "The LG KE850: touchable chocolate," (<http://mobile.engadget.com/2006/12/15/the-lg-ke850-touchable-chocolate/>), published Dec. 15, 2006, 5 pages.
 U.S. Appl. No. 29/423,180, inventors Akana, J., et al., filed on May 29, 2012 (Not Published).

* cited by examiner

Primary Examiner — Barbara Fox
 (74) *Attorney, Agent, or Firm* — Sterne, Kessler, Goldstein & Fox PLLC

(57) **CLAIM**
 The ornamental design for an electronic device, as shown and described.

DESCRIPTION

FIG. 1 is a bottom front perspective view of an electronic device showing our new design;
 FIG. 2 is a bottom rear perspective view thereof;
 FIG. 3 is a top rear perspective view thereof;
 FIG. 4 is a front view thereof;
 FIG. 5 is a rear view thereof;

FIG. 6 is a left side view thereof;
 FIG. 7 is a right side view thereof;
 FIG. 8 is a top view thereof;
 FIG. 9 is a bottom view thereof;
 FIG. 10 is an enlarged view of a portion of the left corner of FIG. 9;
 FIG. 11 is a bottom front perspective view of another embodiment of an electronic device showing our new design;
 FIG. 12 is a bottom rear perspective view thereof;
 FIG. 13 is a top rear perspective view thereof;
 FIG. 14 is a front view thereof;
 FIG. 15 is a rear view thereof;
 FIG. 16 is a left side view thereof;
 FIG. 17 is a right side view thereof;
 FIG. 18 is a top view thereof;
 FIG. 19 is a bottom view thereof;
 FIG. 20 is an enlarged view of a portion of the left corner of FIG. 19;
 FIG. 21 is a bottom front perspective view of an electronic device showing our new design;
 FIG. 22 is a bottom rear perspective view thereof;
 FIG. 23 is a top rear perspective view thereof;
 FIG. 24 is a front view thereof;
 FIG. 25 is a rear view thereof;
 FIG. 26 is a left side view thereof;
 FIG. 27 is a right side view thereof;
 FIG. 28 is a top view thereof;
 FIG. 29 is a bottom view thereof; and,
 FIG. 30 is an enlarged view of a portion of the left corner of FIG. 29.

The broken lines in the Figures show portions of the electronic device which form no part of the claimed design.
 The shade lines in the Figures show contour or a transparent, reflective, or shiny surface, and not surface ornamentation.

1 Claim, 24 Drawing Sheets

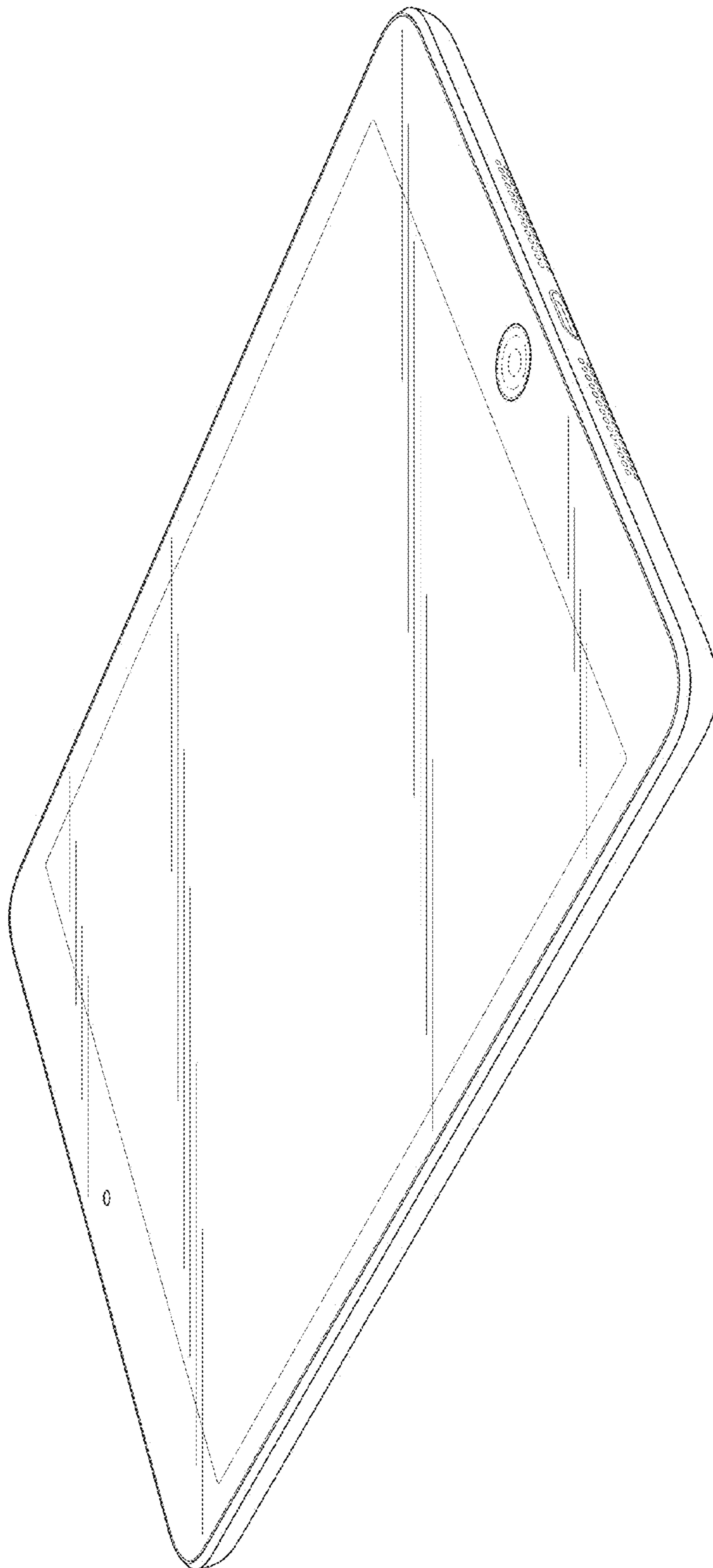

FIG. 1

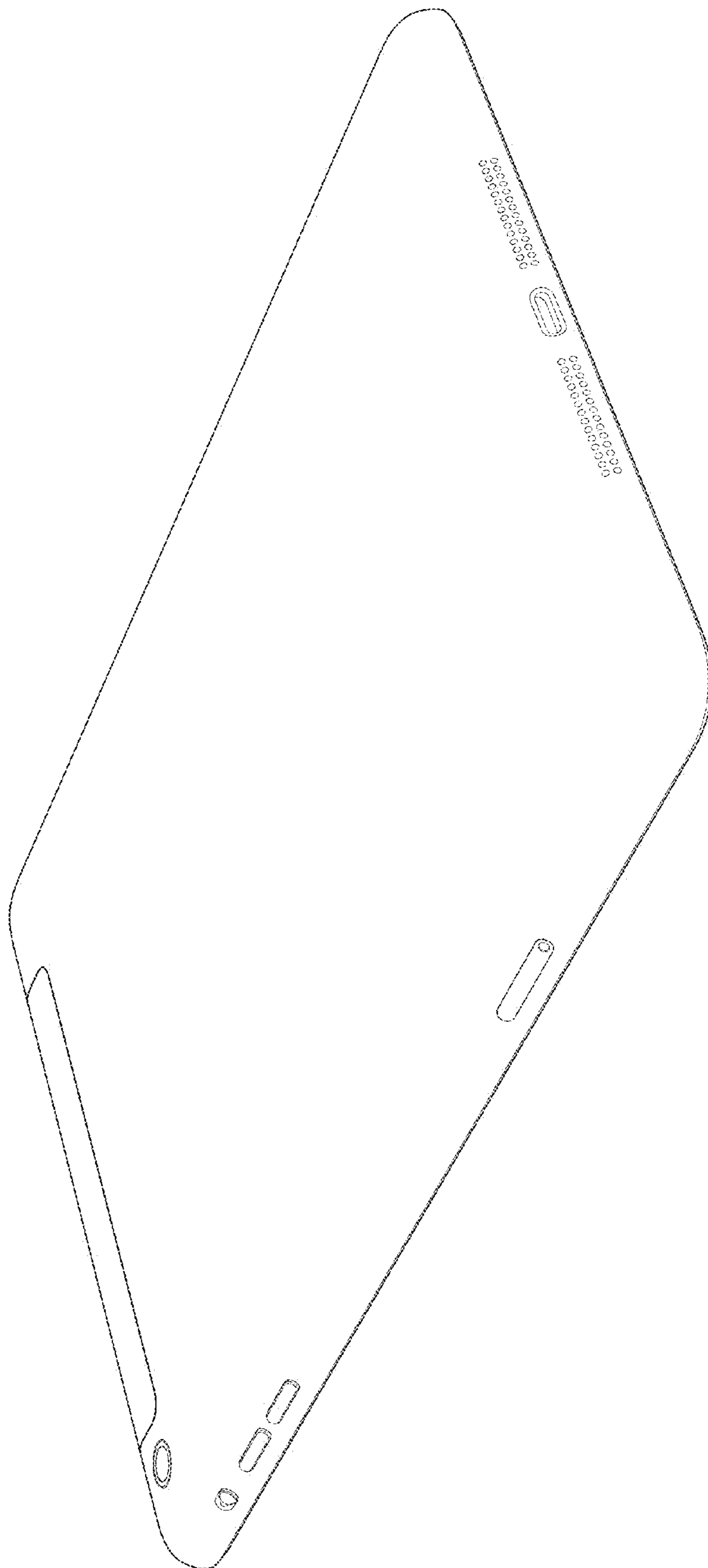

FIG. 2

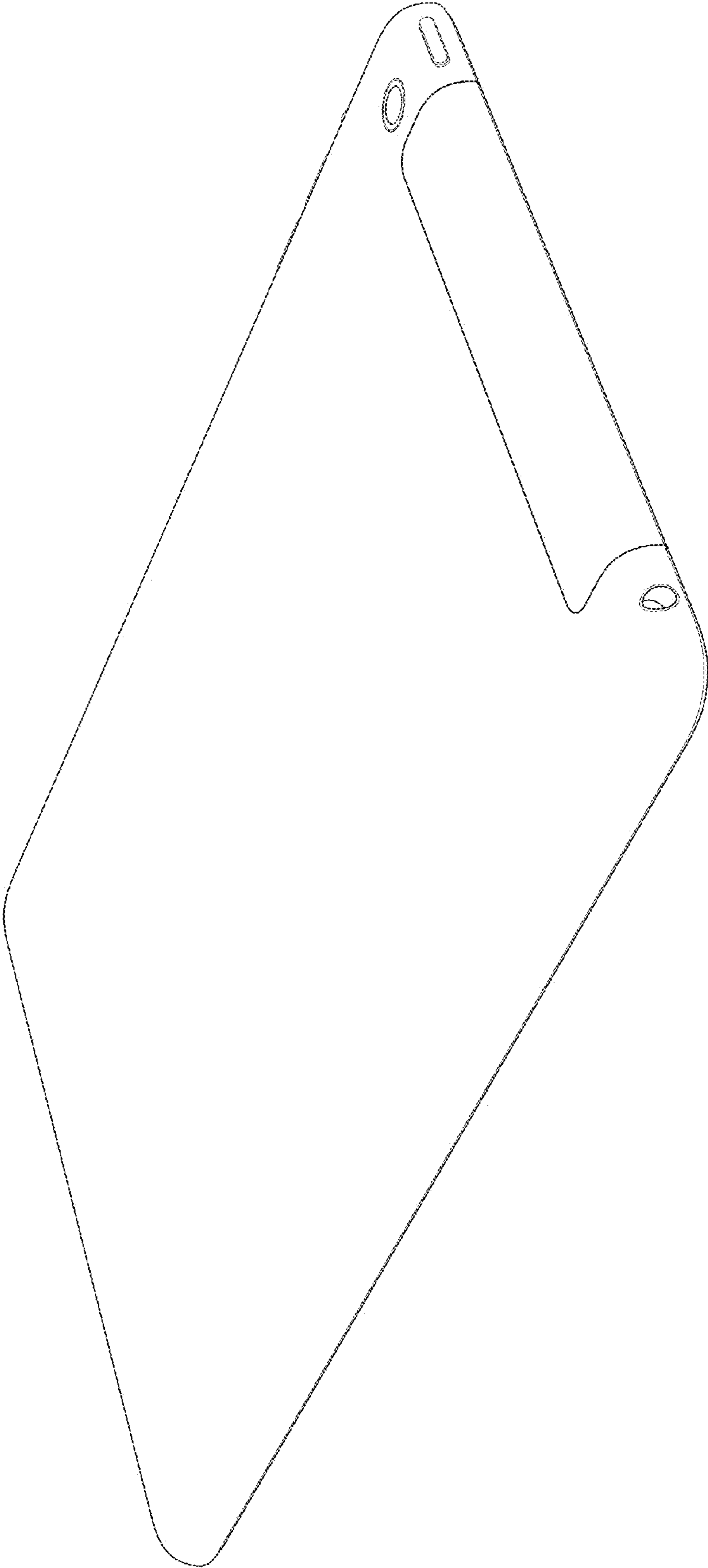

FIG. 3

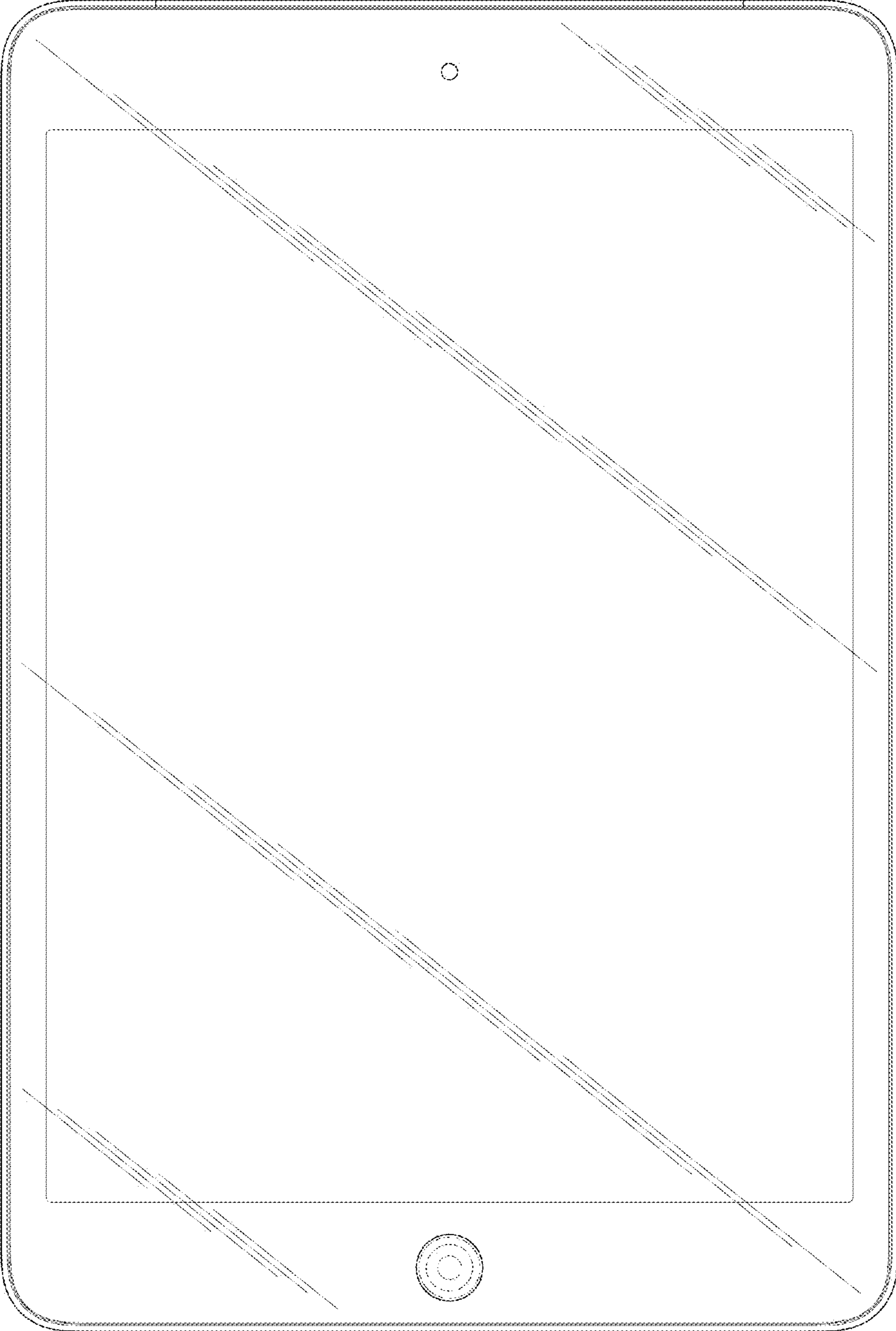

FIG. 4

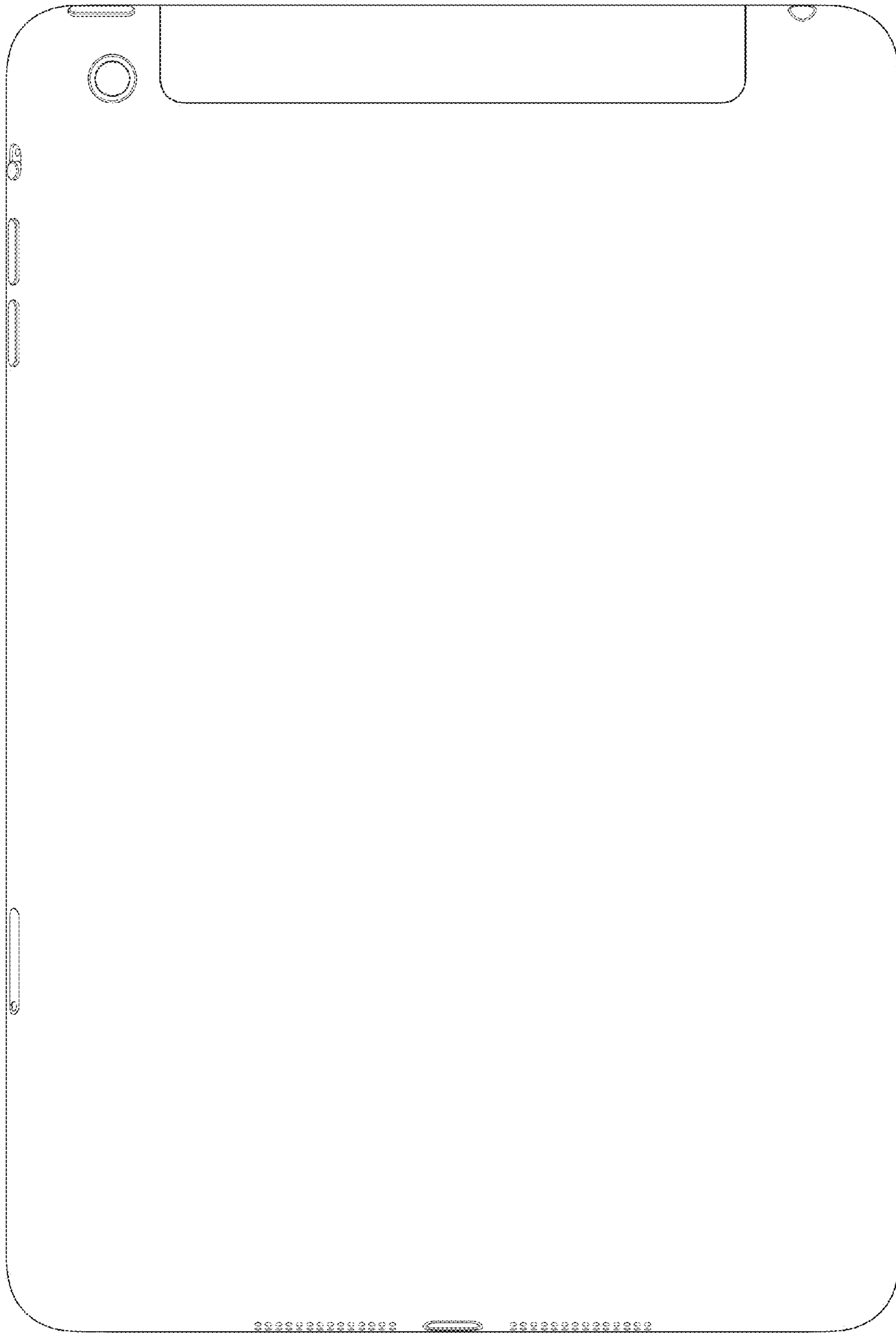

FIG. 5



FIG. 6

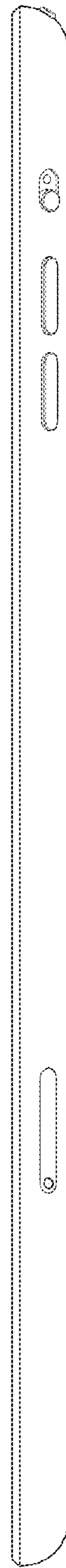

FIG. 7



FIG. 8



FIG. 9

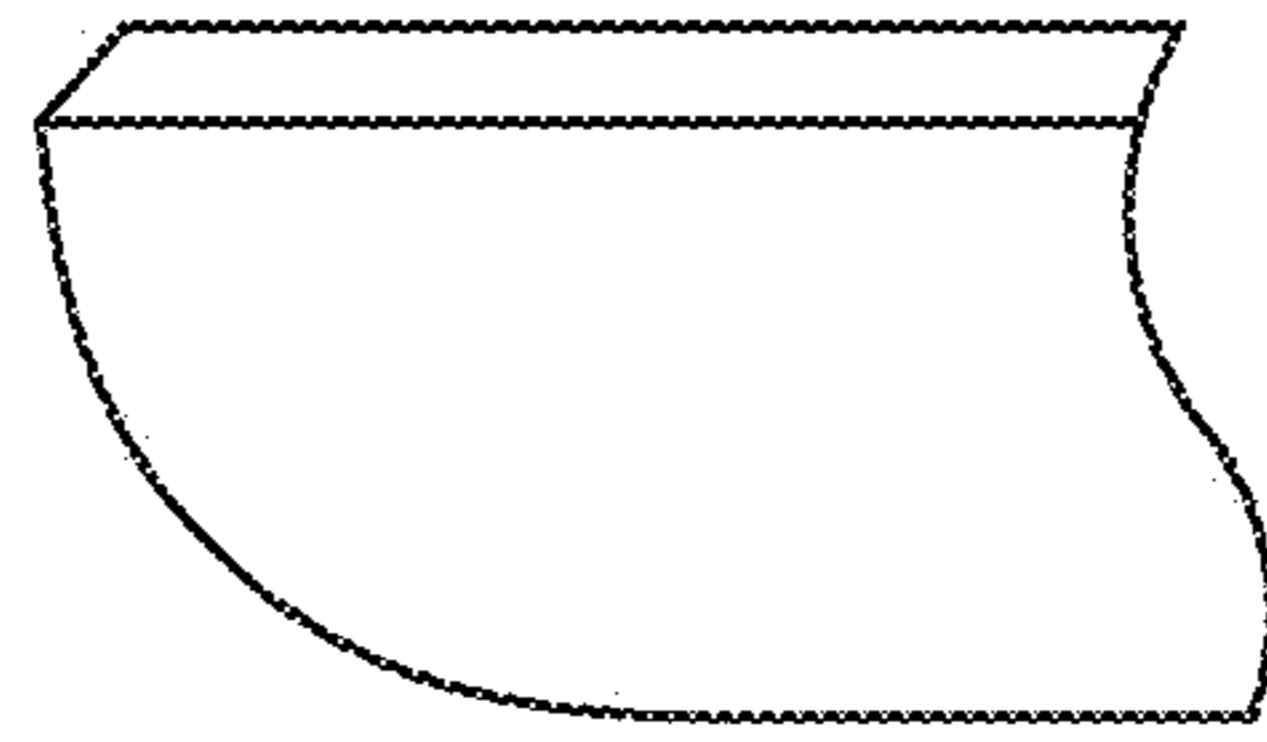

FIG. 10

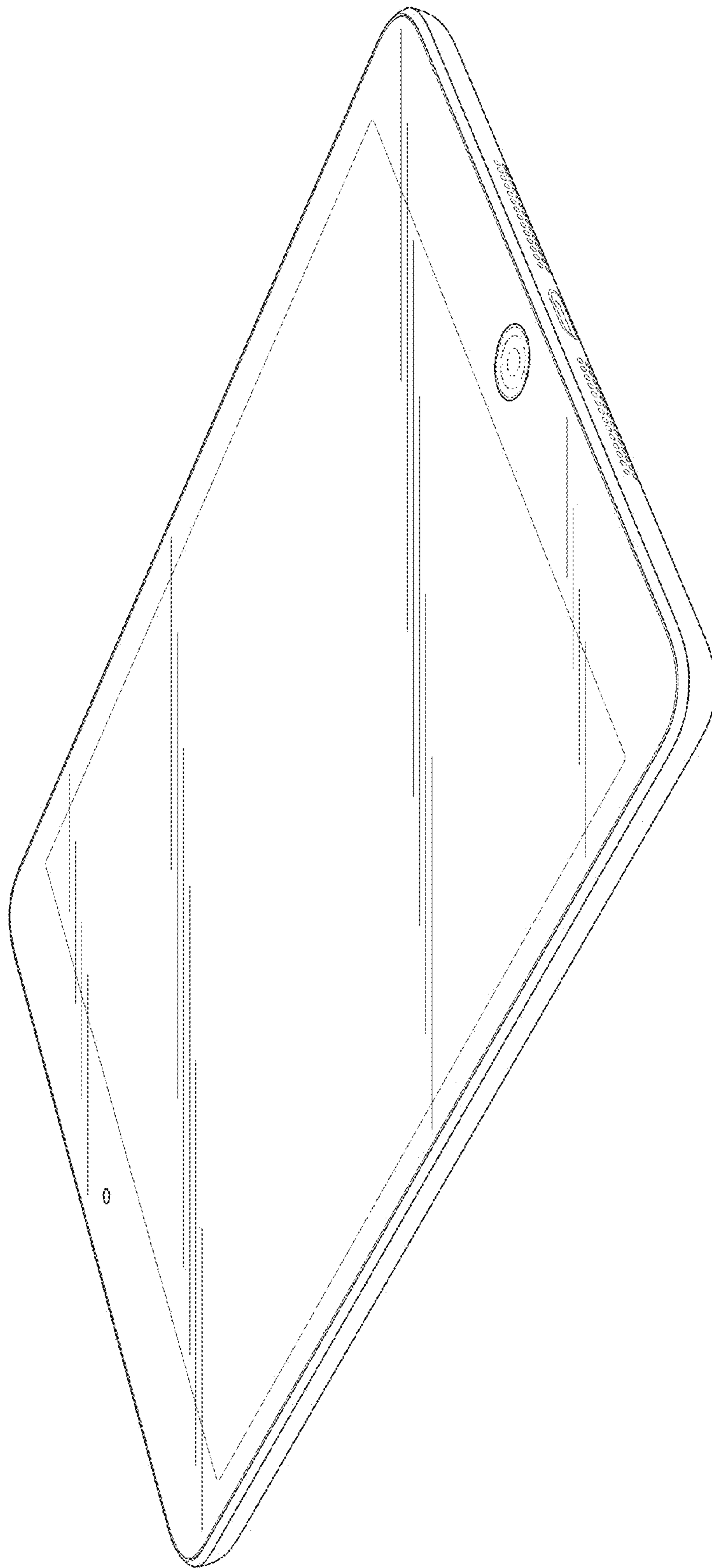

FIG. 11

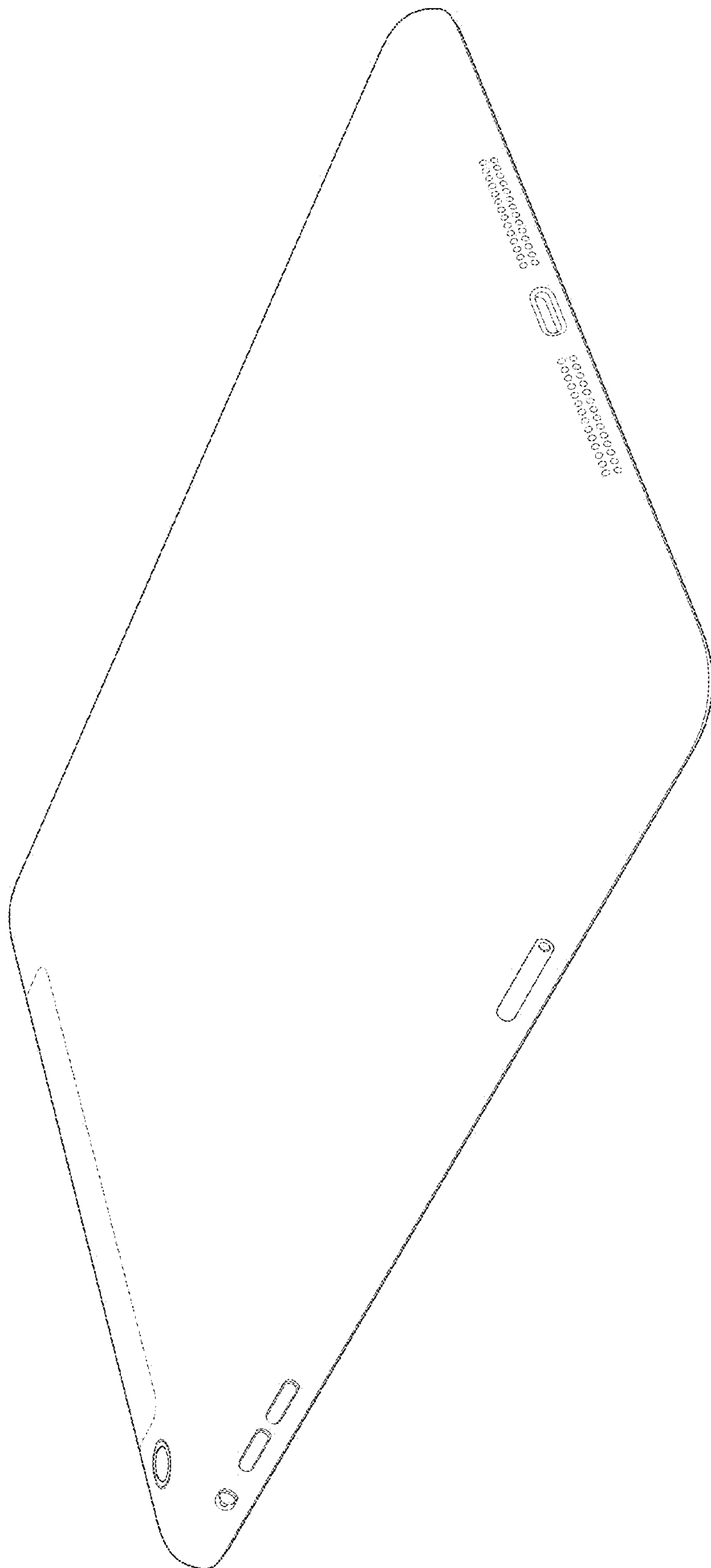

FIG. 12

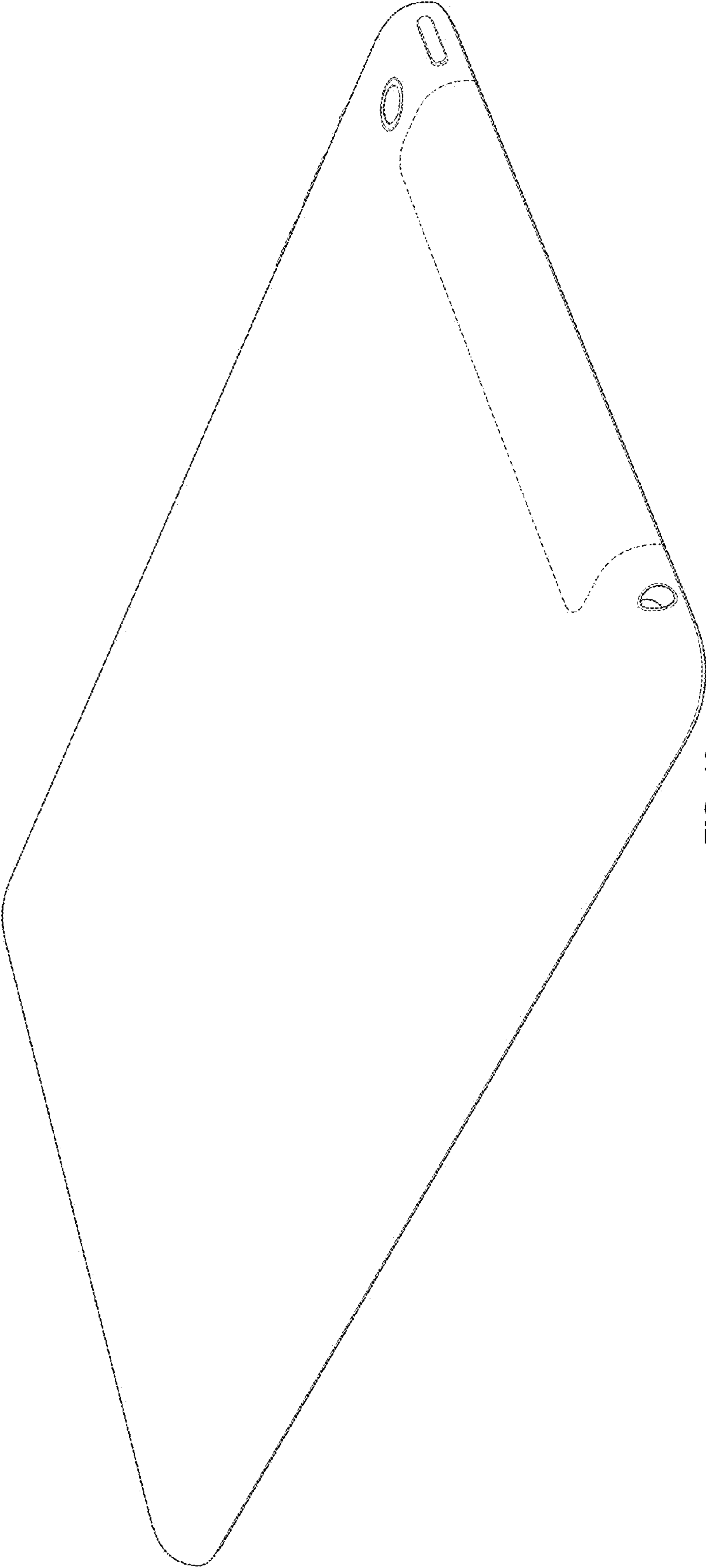

FIG. 13

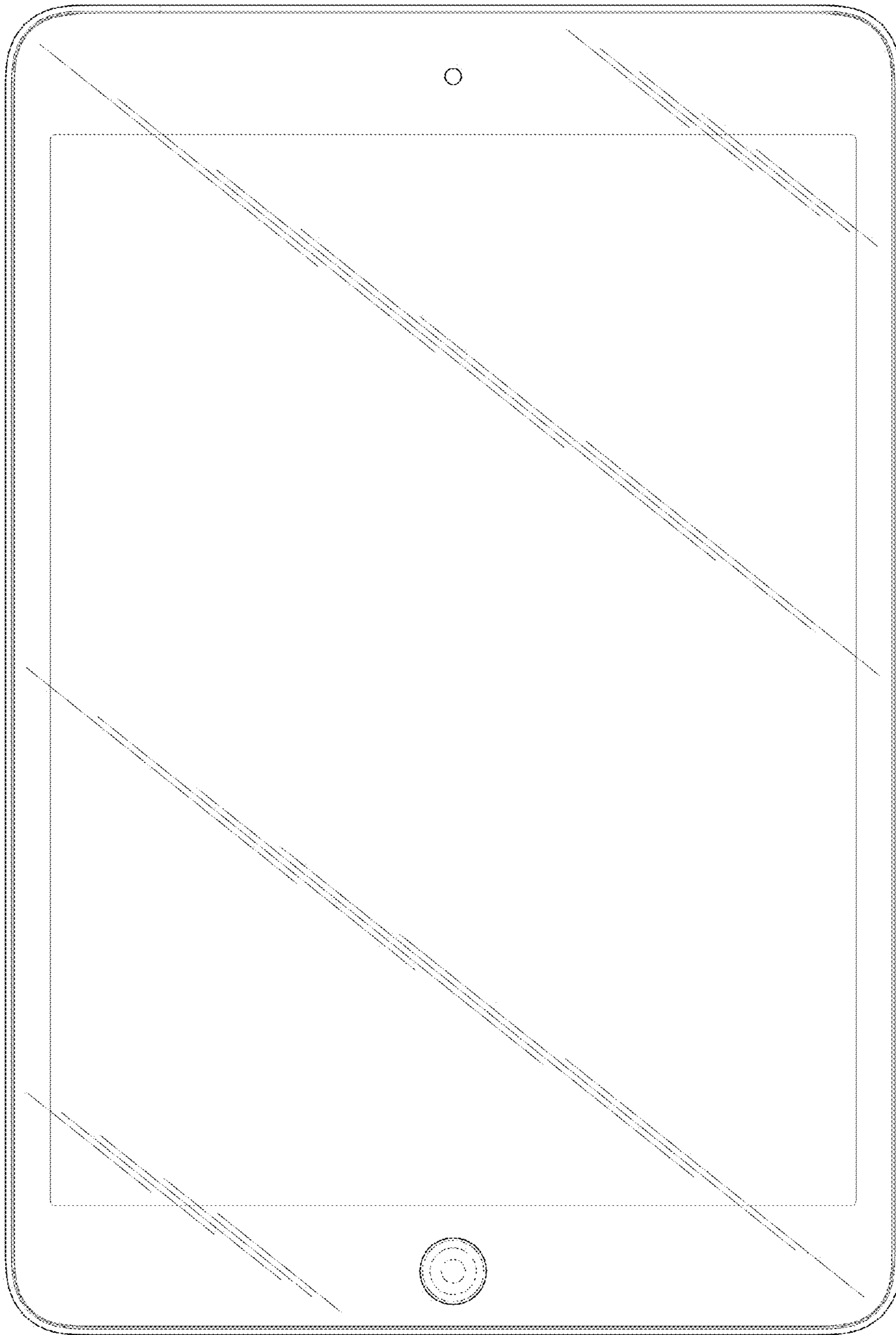

FIG. 14

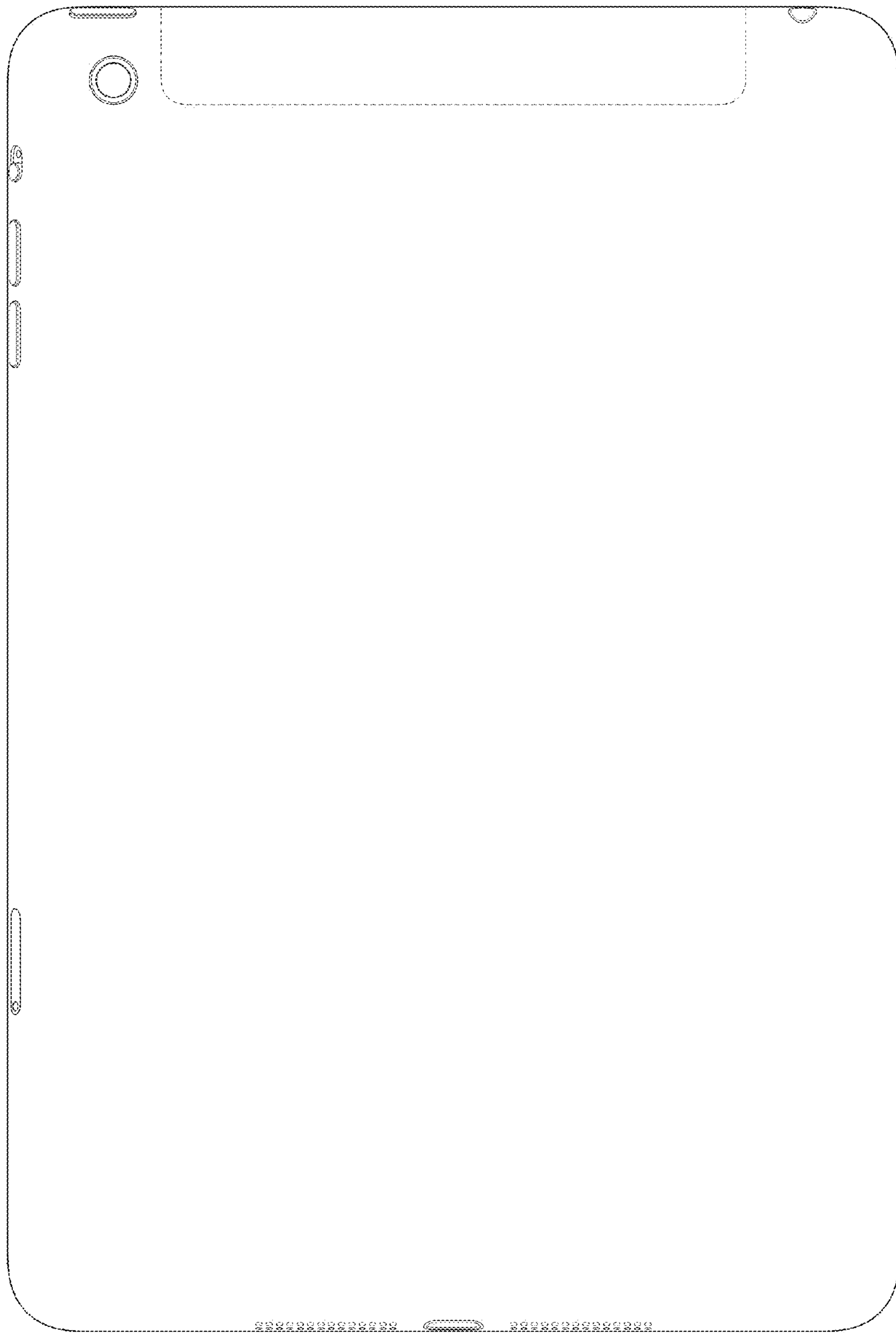

FIG. 15

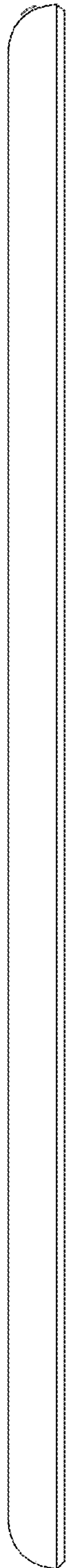

FIG. 16



FIG. 17



FIG. 18

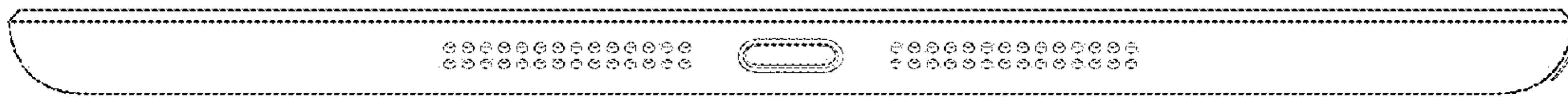

FIG. 19

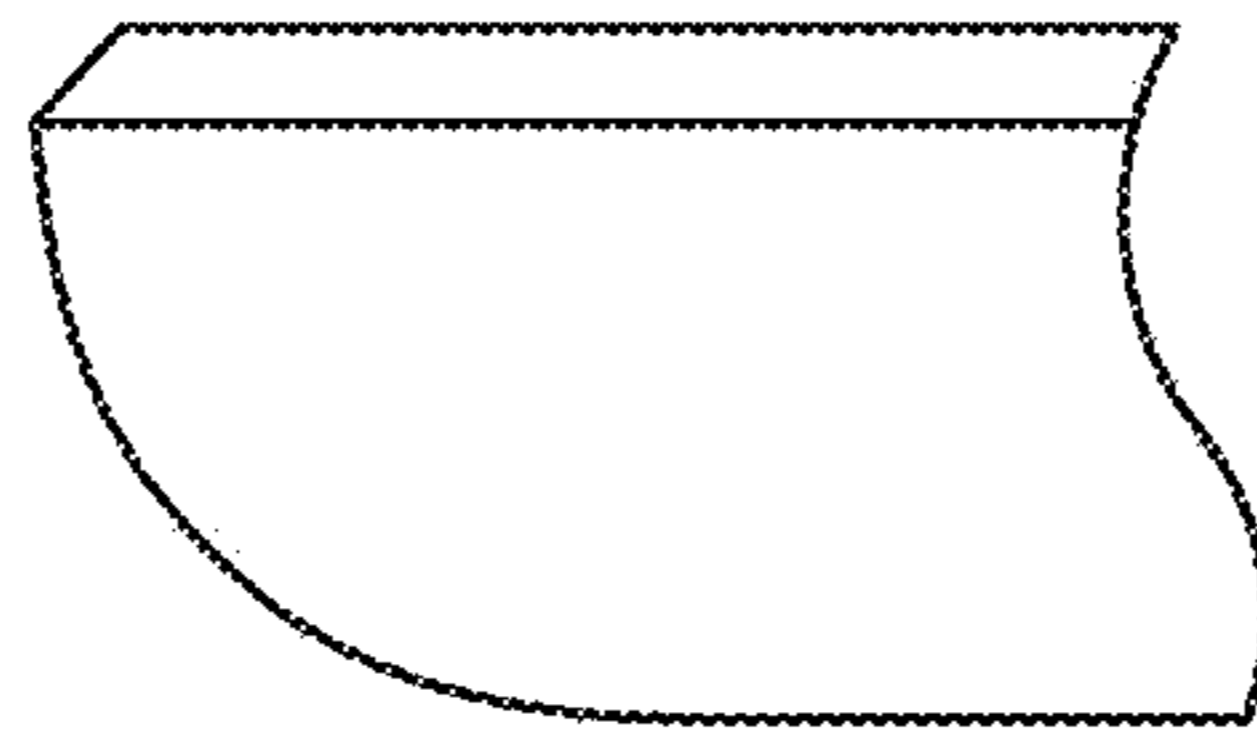

FIG. 20

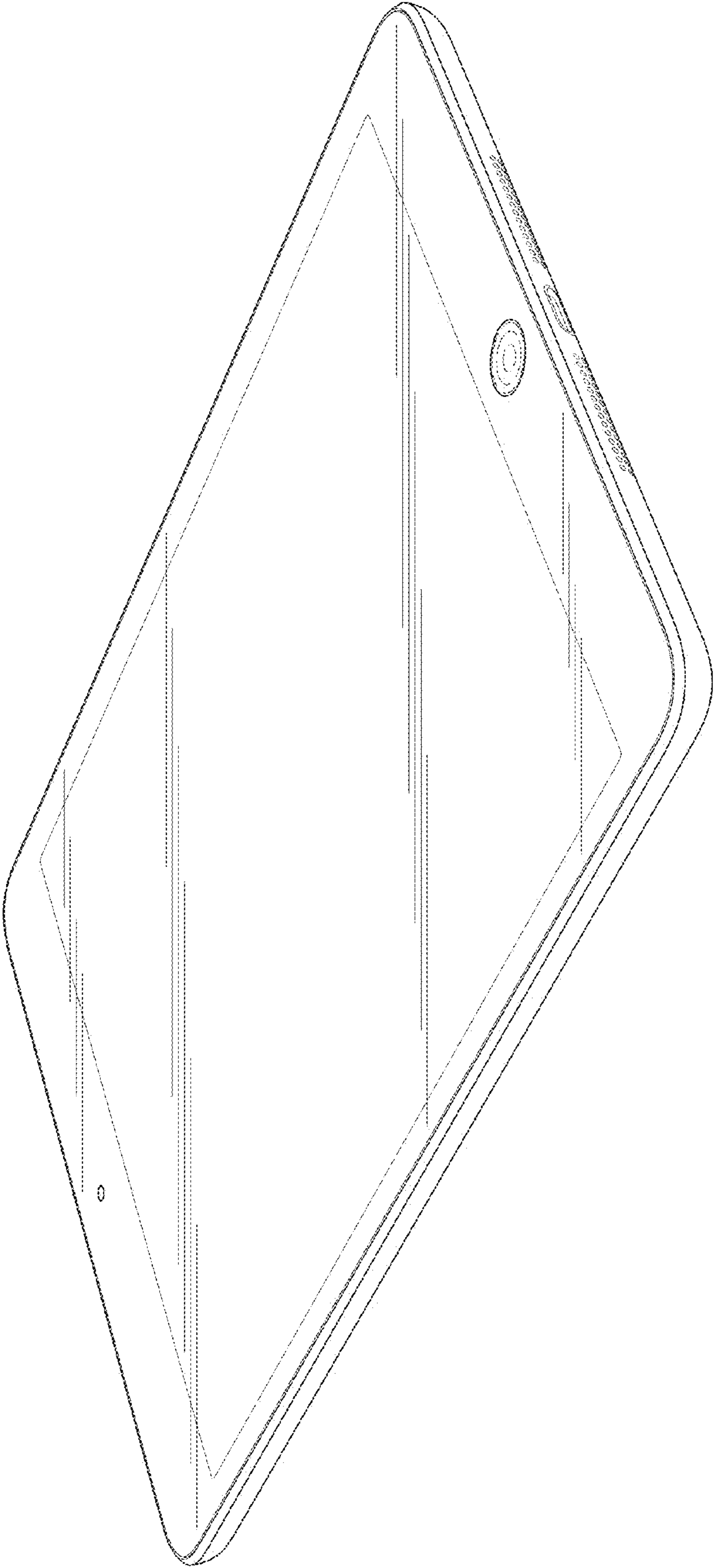

FIG. 21

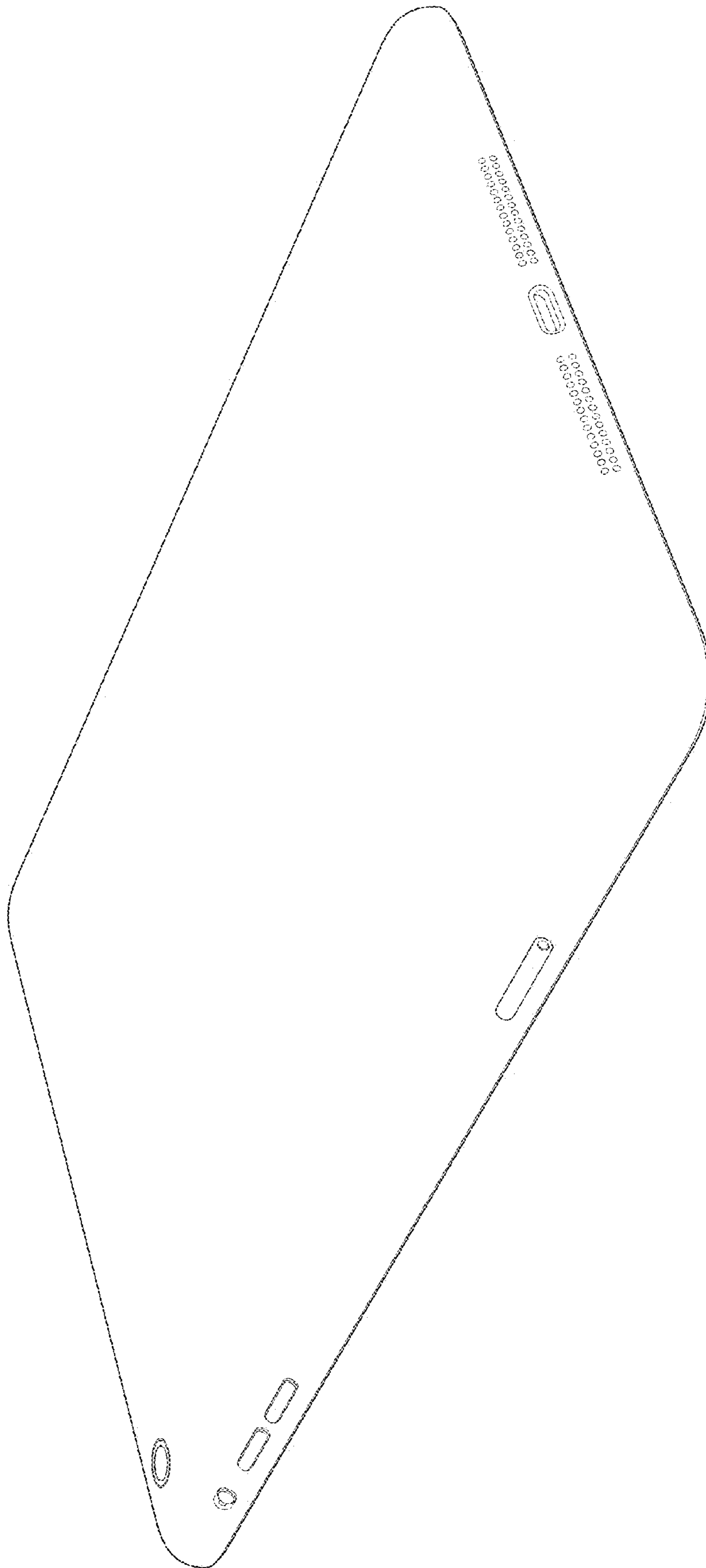

FIG. 22

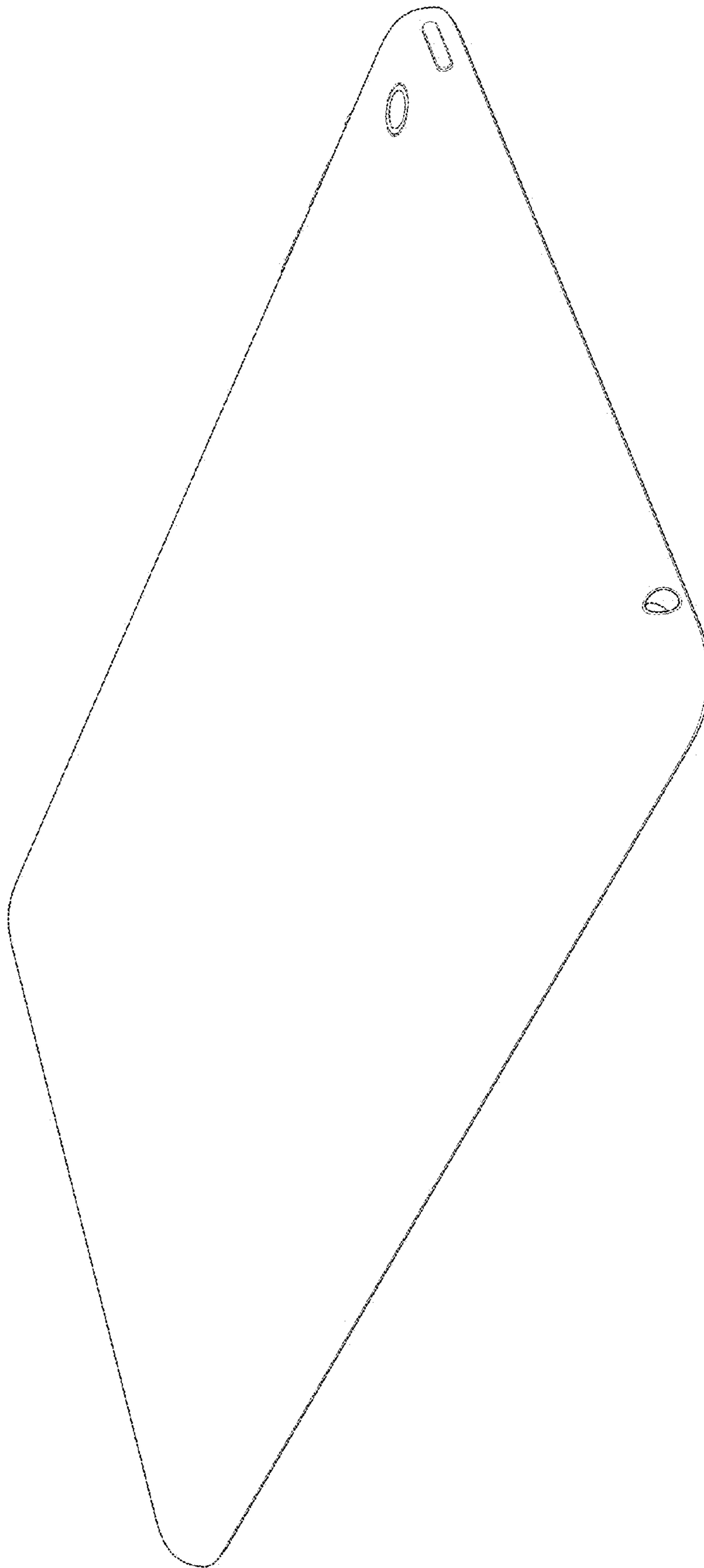

FIG. 23

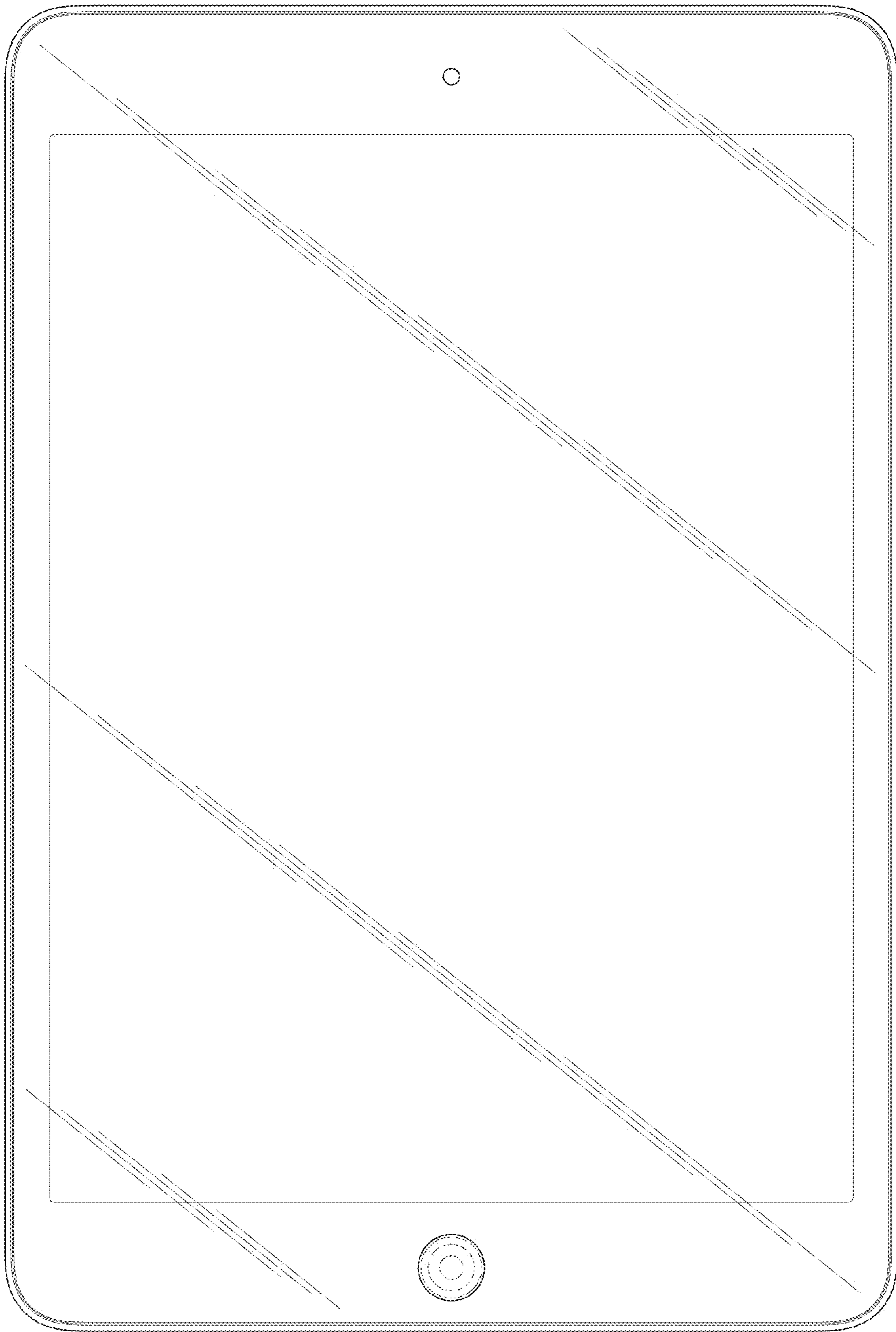

FIG. 24

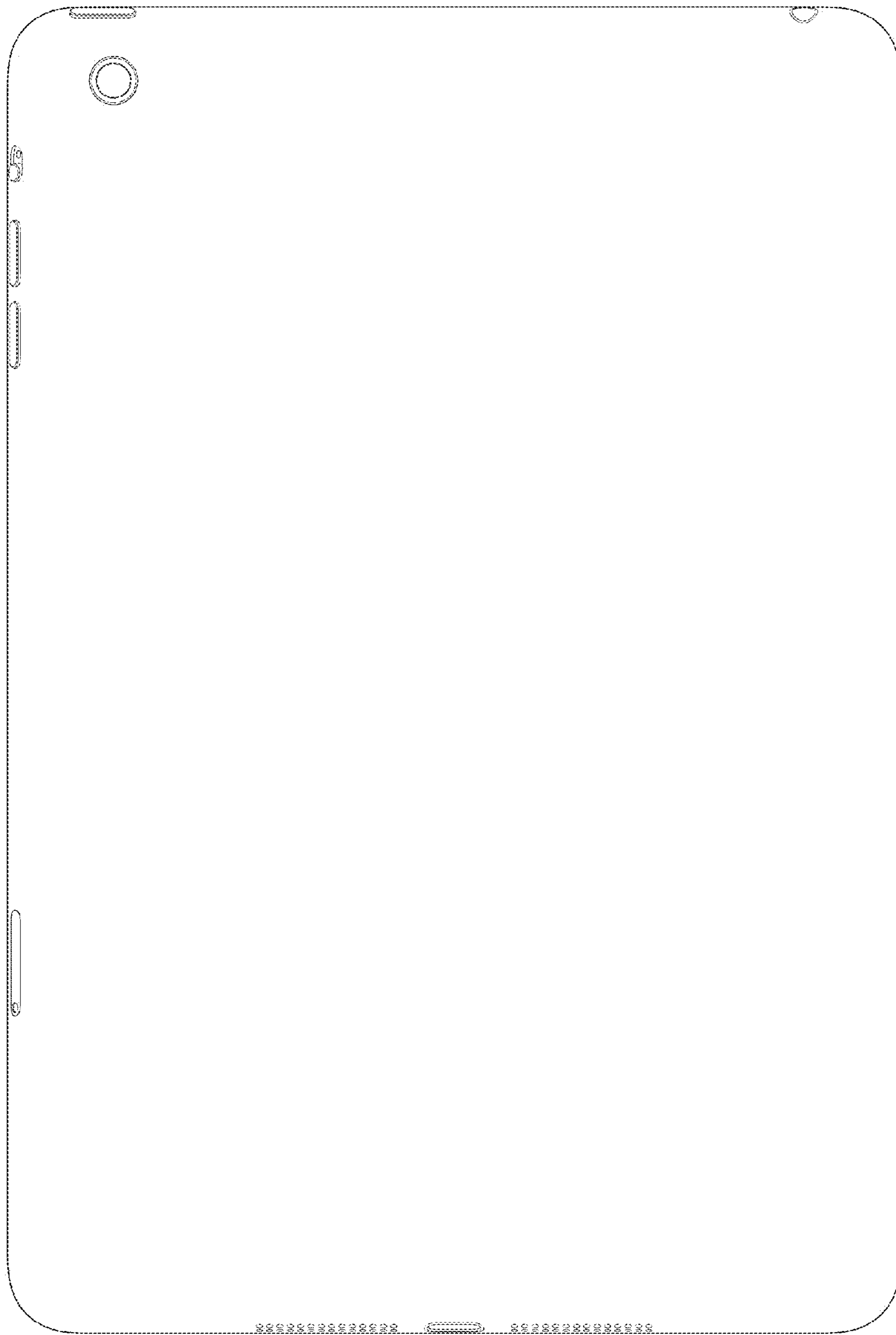

FIG. 25

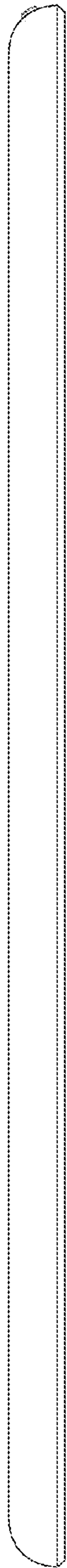

FIG. 26

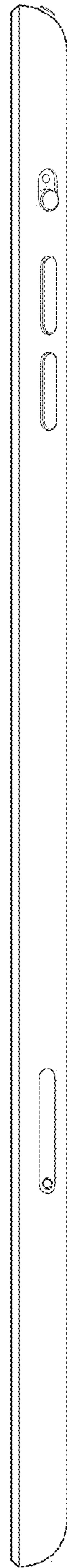

FIG. 27



FIG. 28

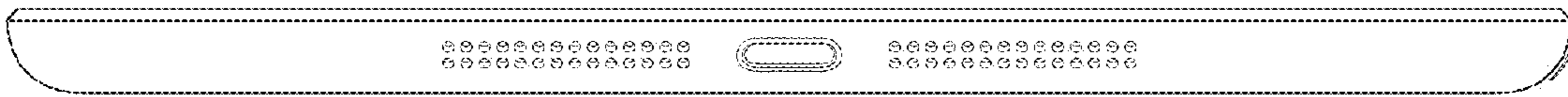

FIG. 29

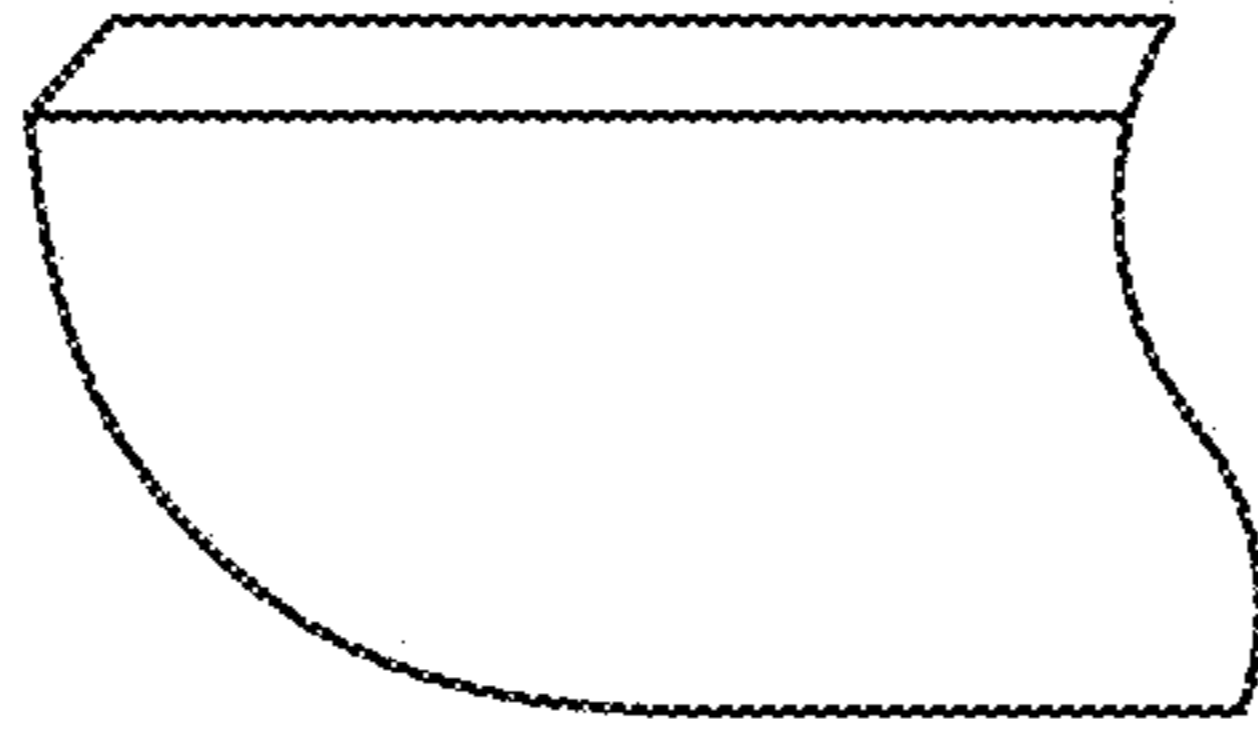

FIG. 30