



US00D681576S

(12) **United States Design Patent**
Lee et al.

(10) **Patent No.:** **US D681,576 S**
(45) **Date of Patent:** **** May 7, 2013**

(54) **TELEVISION RECEIVER**

(75) Inventors: **Yongho Lee**, Seoul (KR); **Jinhee Kim**, Seoul (KR); **Nari Lee**, Seoul (KR); **Yeonga Lee**, Seoul (KR)

(73) Assignee: **LG Electronics Inc.**, Seoul (KR)

(**) Term: **14 Years**

(21) Appl. No.: **29/423,826**

(22) Filed: **Jun. 5, 2012**

(30) **Foreign Application Priority Data**

Dec. 6, 2011 (KR) 30-2011-0051784

(51) **LOC (9) Cl.** **14-03**

(52) **U.S. Cl.**
USPC **D14/126**

(58) **Field of Classification Search** D14/125-134,
D14/239, 371, 374-377; 312/7.2; 341/12;
248/917-924; 345/104, 133, 156, 168, 87,
345/173; 720/605, 669, 600, 655; 369/99,
369/197; 455/344, 347; D21/329, 515, 577,
D21/622, 333, 433, 448, 452, 450, 331; D6/477,
D6/479, 300; 273/148 B; 446/484, 175,
446/356; D10/15, 26

See application file for complete search history.

(56) **References Cited**

U.S. PATENT DOCUMENTS

D616,400	S	*	5/2010	Lee et al.	D14/126
D618,640	S	*	6/2010	Won et al.	D14/126
D620,901	S	*	8/2010	Won et al.	D14/126
D624,512	S	*	9/2010	Kim et al.	D14/126
D635,976	S	*	4/2011	Lee et al.	D14/374
D639,256	S	*	6/2011	Lee et al.	D14/126
D646,243	S	*	10/2011	Honda	D14/126
D658,613	S	*	5/2012	Lee et al.	D14/126

* cited by examiner

Primary Examiner — Raphael Barkai

(74) *Attorney, Agent, or Firm* — Birch, Stewart, Kolasch & Birch, LLP

(57) **CLAIM**

The ornamental design for a television receiver, as shown and described.

DESCRIPTION

FIG. 1 is a perspective view of a television receiver showing our new design;
FIG. 2 is a front view thereof;
FIG. 3 is a rear view thereof;
FIG. 4 is a left side view thereof;
FIG. 5 is a right side view thereof;
FIG. 6 is a top plan view thereof;
FIG. 7 is a bottom plan view thereof; and,
FIG. 8 is a rear perspective view thereof.

1 Claim, 7 Drawing Sheets

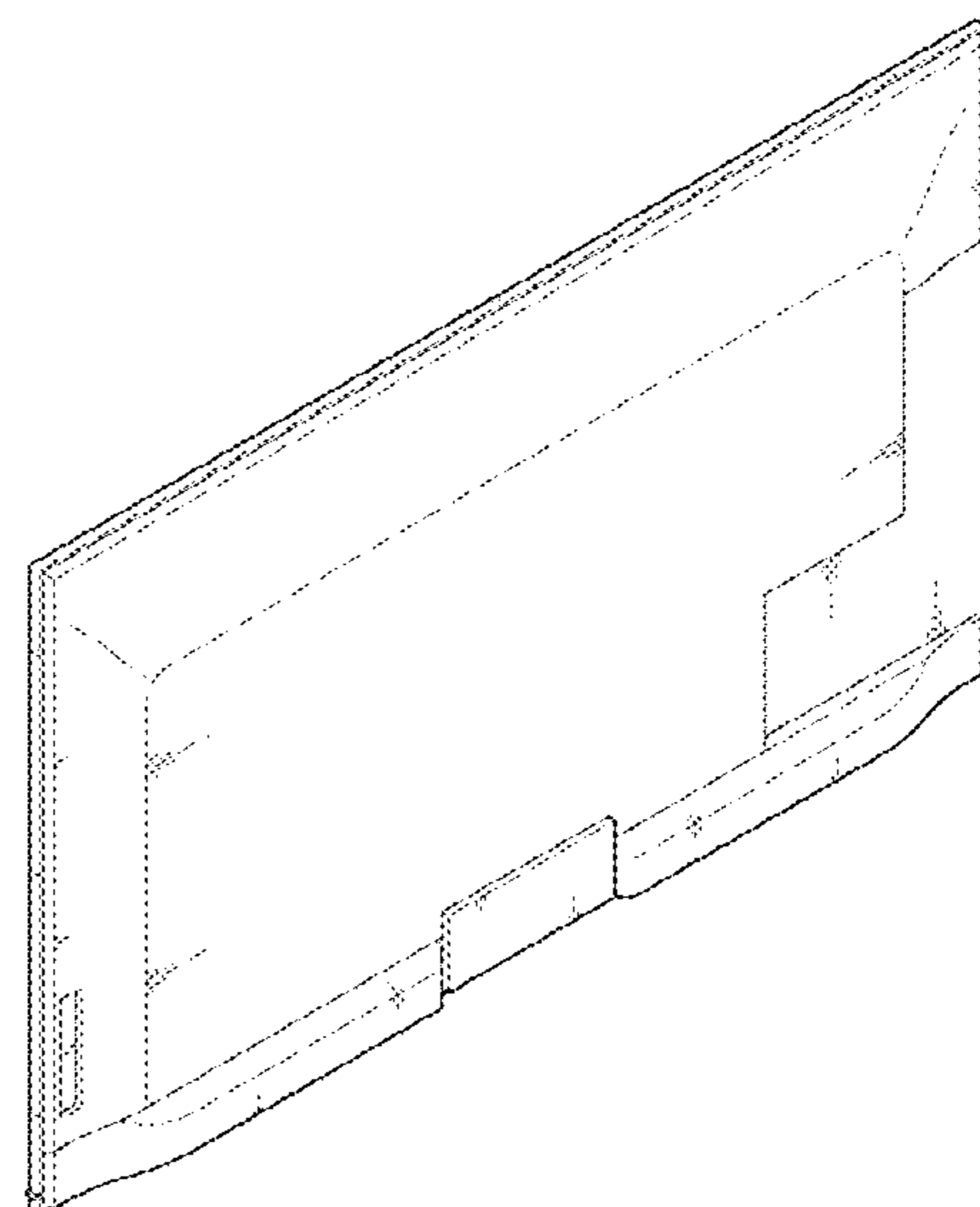
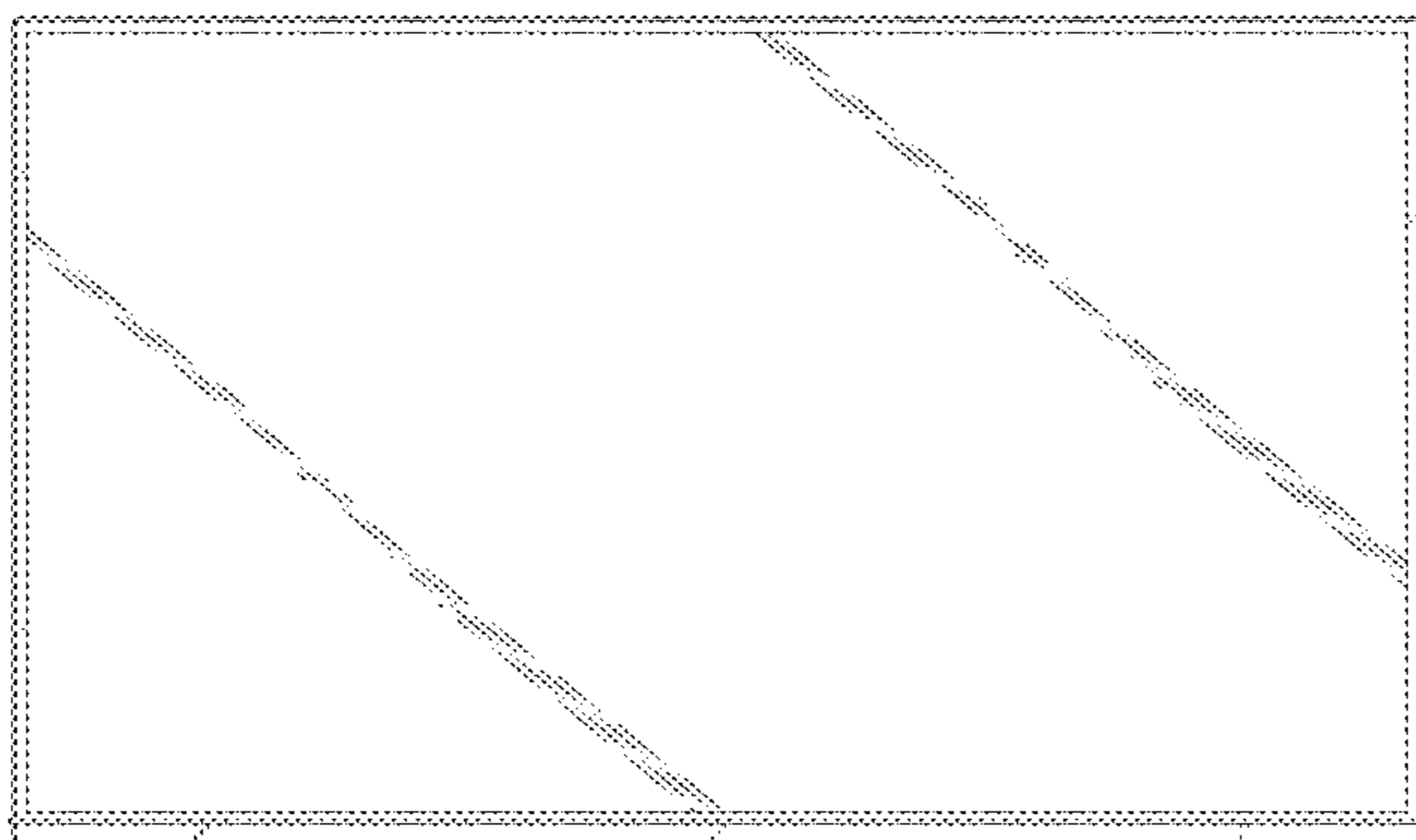

FIG. 1

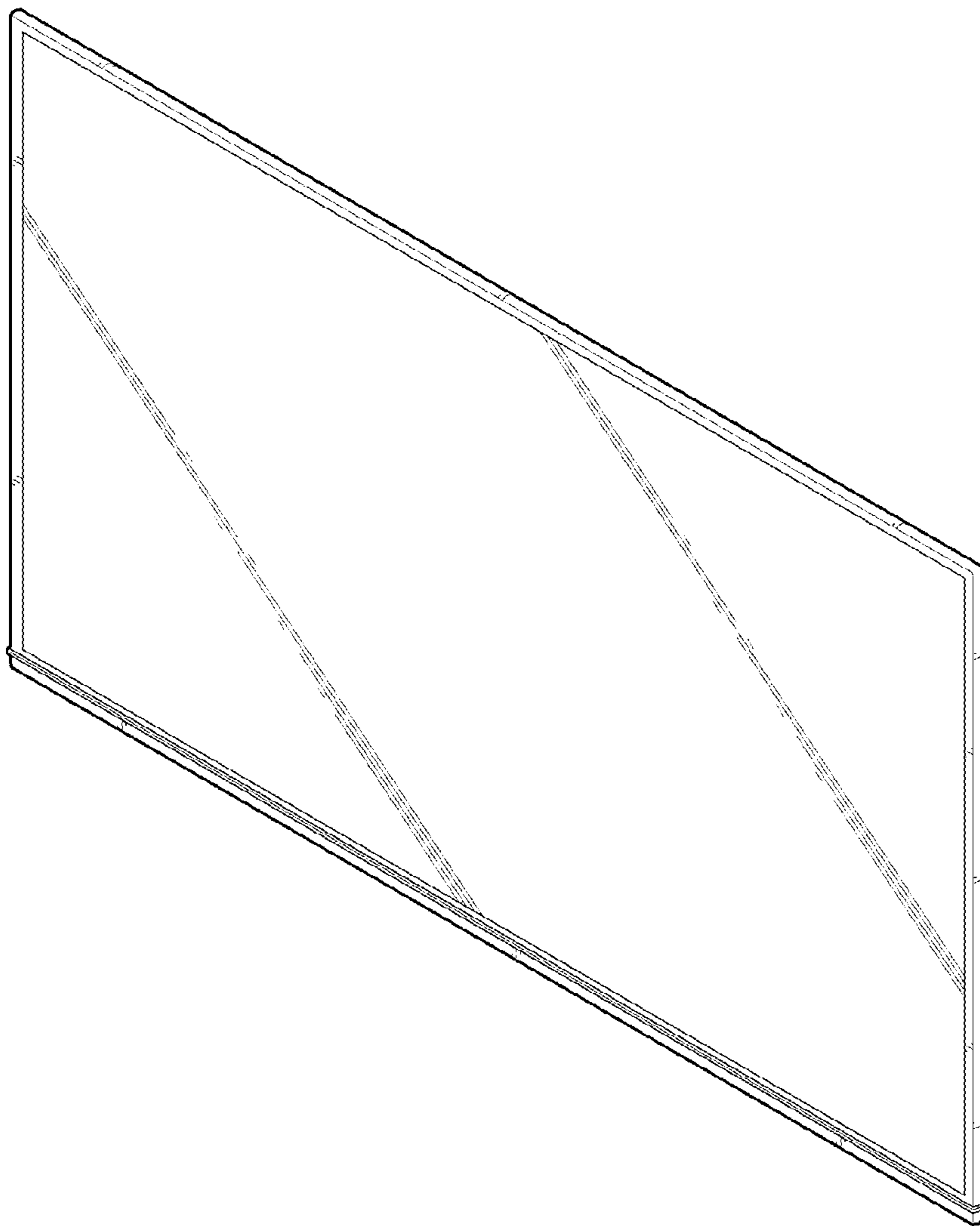

FIG. 2

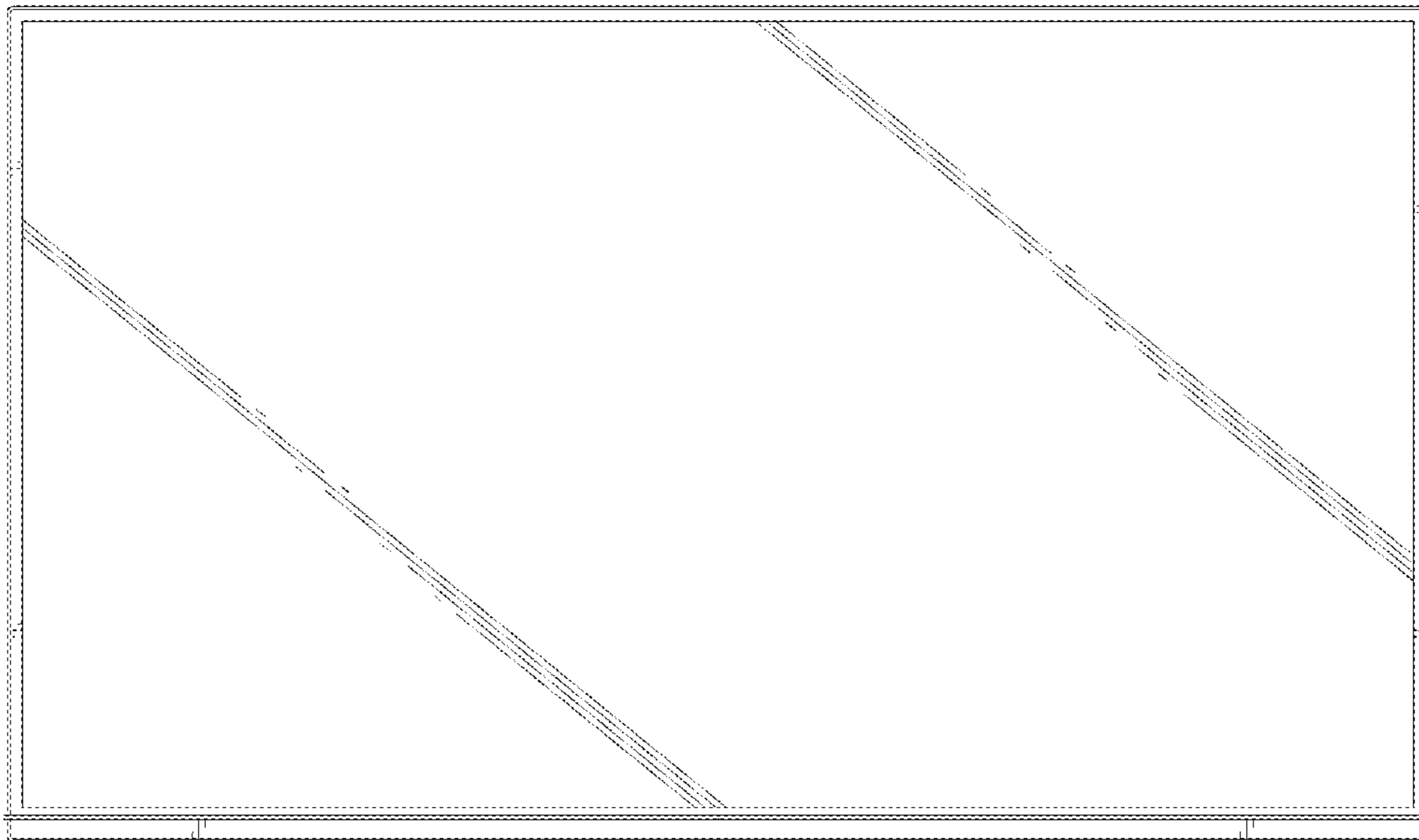

FIG. 3

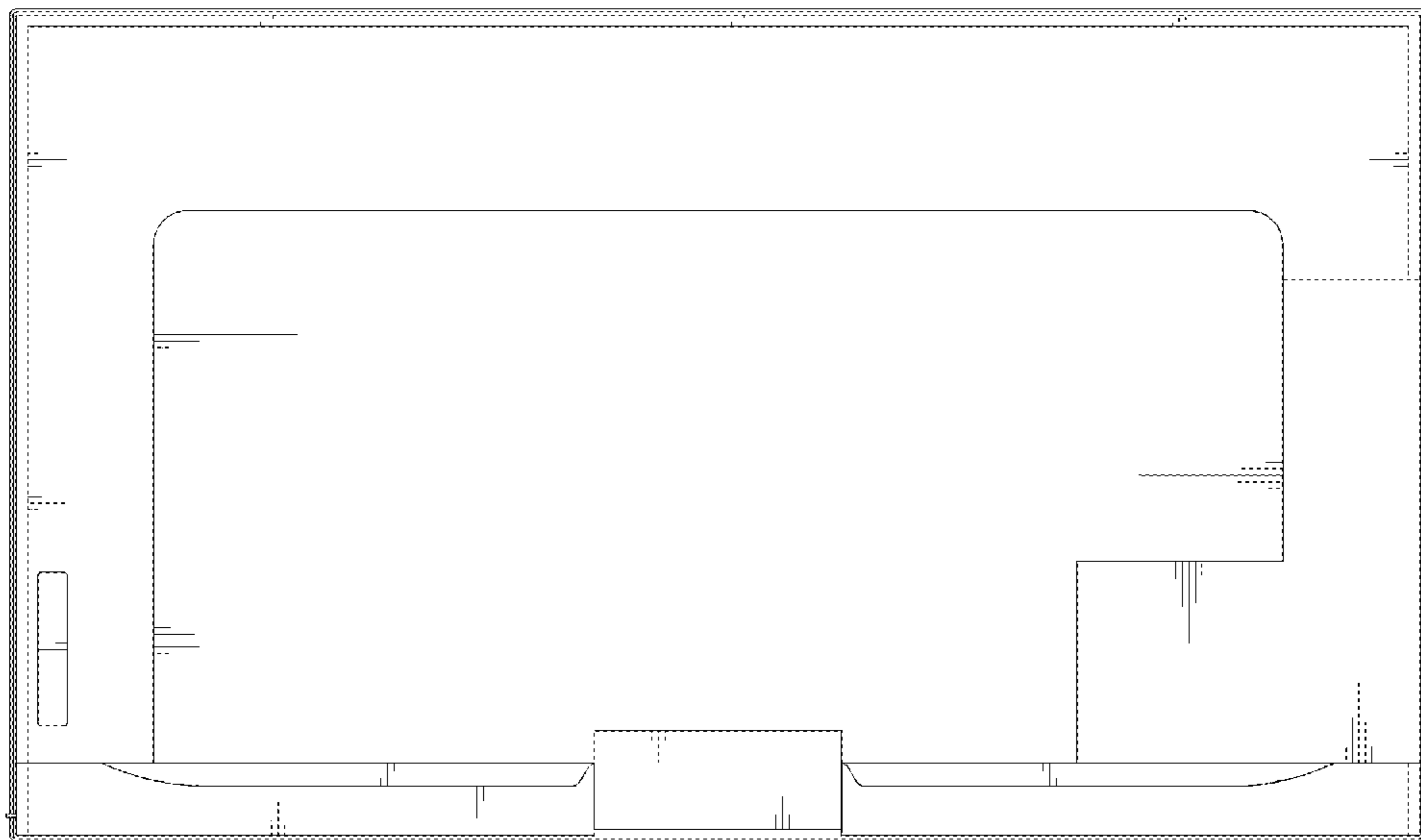

FIG. 4

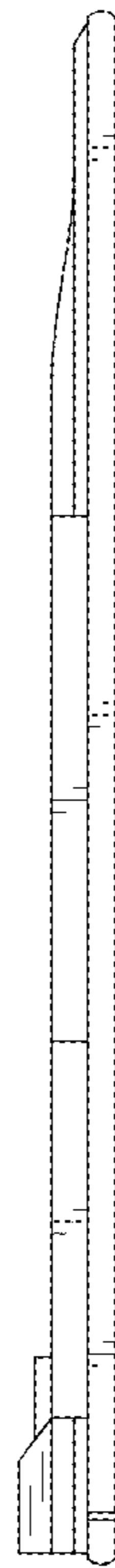

FIG. 5

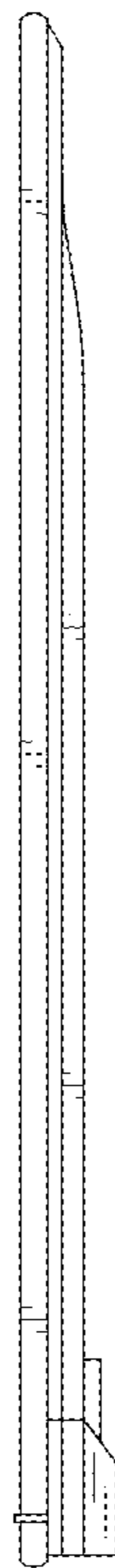

FIG. 6

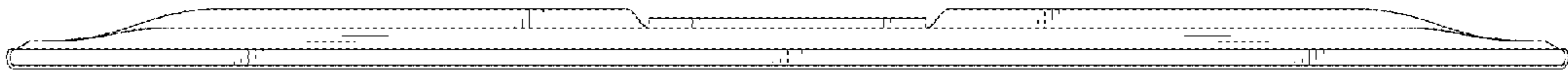

FIG. 7

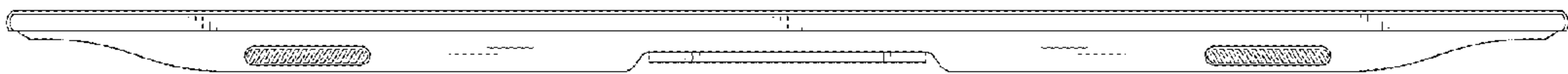

FIG. 8

