



US00D681460S

(12) **United States Design Patent**  
**Kim**

(10) **Patent No.:** **US D681,460 S**

(45) **Date of Patent:** **\*\* May 7, 2013**

(54) **CONTAINER CAP**

*Primary Examiner* — Susan Bennett Hattan

(76) Inventor: **Jeong-seon Kim**, Santa Fe Springs, CA  
(US)

(74) *Attorney, Agent, or Firm* — John K. Park; Park Law Firm

(\*\*) Term: **14 Years**

(21) Appl. No.: **29/410,513**

(57) **CLAIM**

The ornamental design for a container cap, as shown and described.

(22) Filed: **Jan. 9, 2012**

(51) **LOC (9) Cl.** ..... **09-07**

(52) **U.S. Cl.**  
USPC ..... **D9/452; D9/443**

**DESCRIPTION**

(58) **Field of Classification Search** ..... D9/667,  
D9/454, 453, 452, 450, 449, 445, 443, 441,  
D9/435; D23/253, 250; 220/270–276; 215/228,  
215/217–223, 209

See application file for complete search history.

FIG. 1 is a perspective view of a container cap showing my new design;

FIG. 2 is a front plan view thereof;

FIG. 3 is a front plan view of a container cap showing my new design;

FIG. 4 is a rear plan view thereof;

FIG. 5 is a side plan view thereof;

FIG. 6 is a top plan view thereof;

FIG. 7 is a bottom plan view thereof; and,

FIG. 8 is a perspective partially cross-sectional view thereof with half cutout.

The broken line showing of environment is for illustrative purposes only and forms no part of the claimed design.

(56) **References Cited**

U.S. PATENT DOCUMENTS

D9,309 S *	5/1876	Burnham	.....	D23/253
D252,339 S *	7/1979	Okano	.....	D23/253
D274,084 S *	5/1984	Yanagi	.....	D23/253
D491,063 S *	6/2004	Hicks et al.	.....	D9/443
D579,332 S *	10/2008	Krivoshein	.....	D9/453
D644,105 S *	8/2011	Thielman et al.	.....	D9/452

\* cited by examiner

**1 Claim, 4 Drawing Sheets**

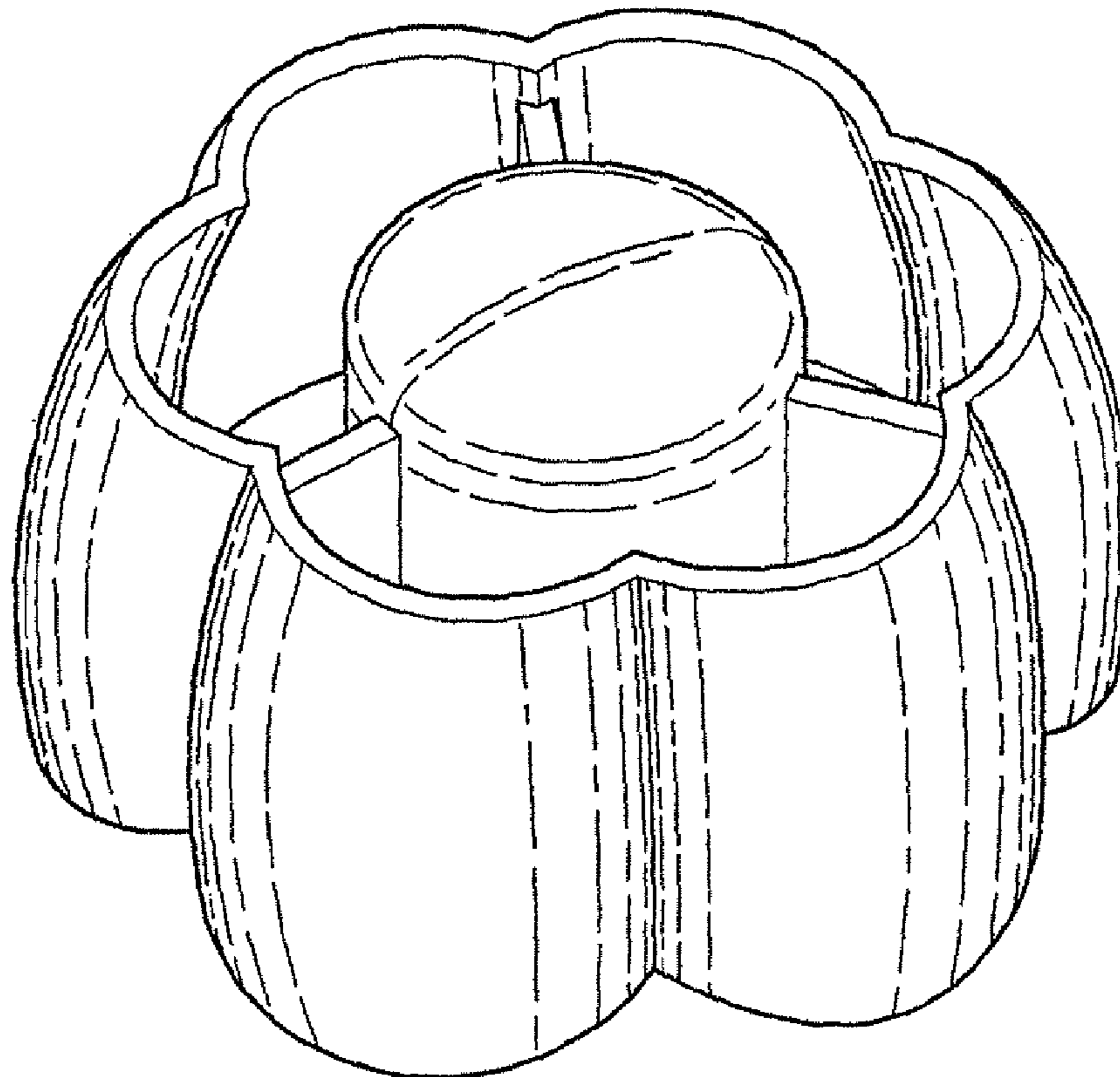

FIG. 1

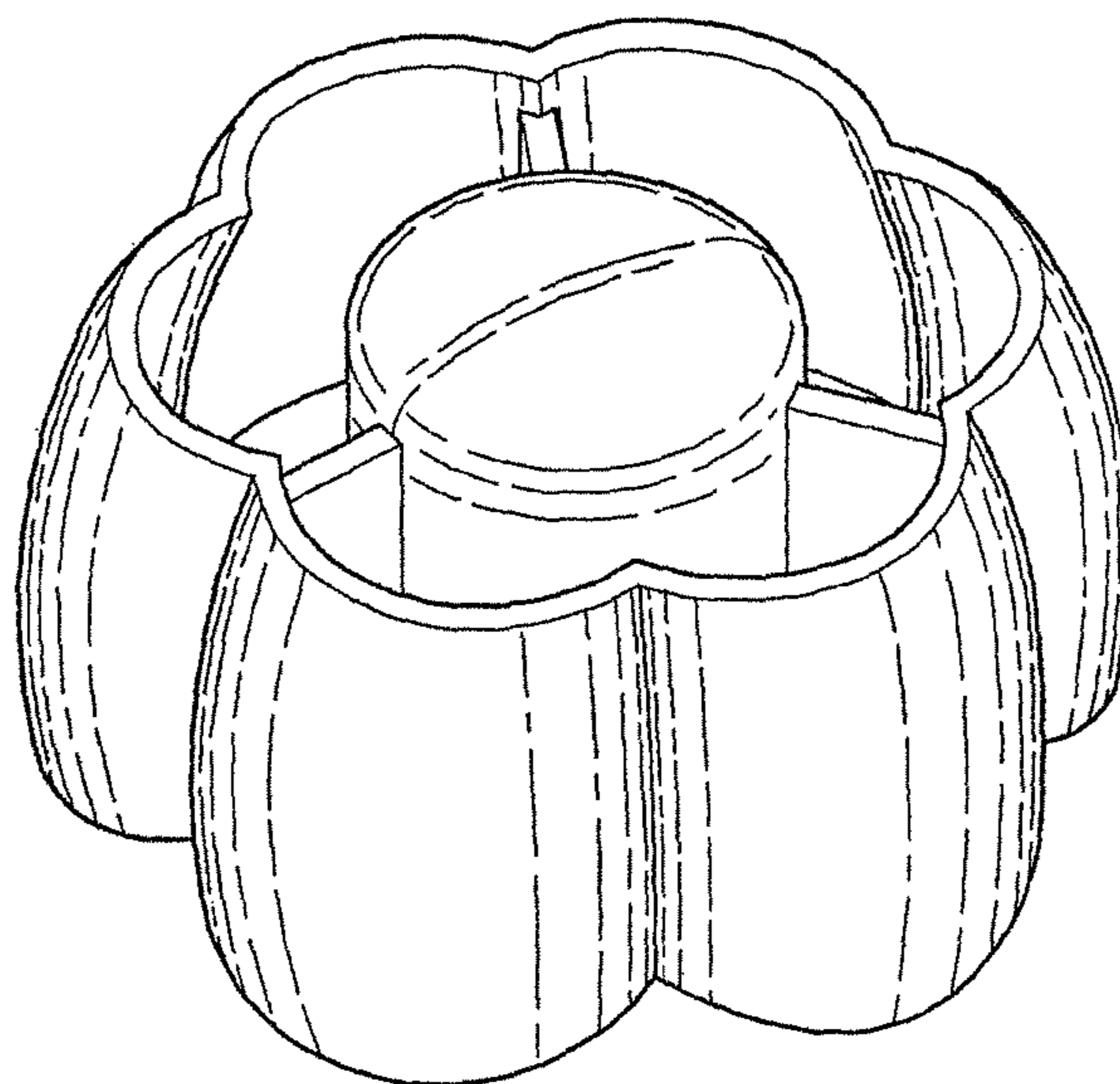

FIG. 2

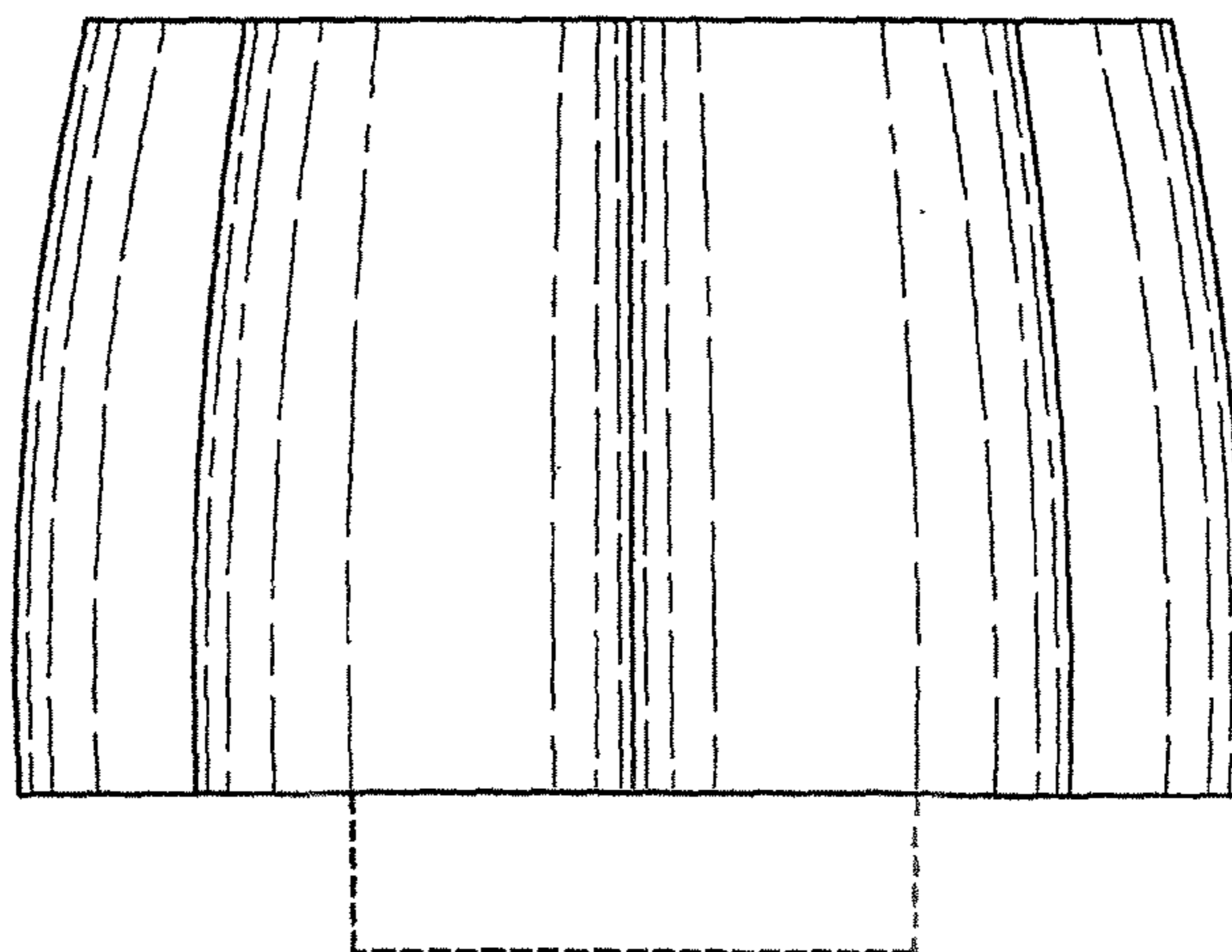

FIG. 3

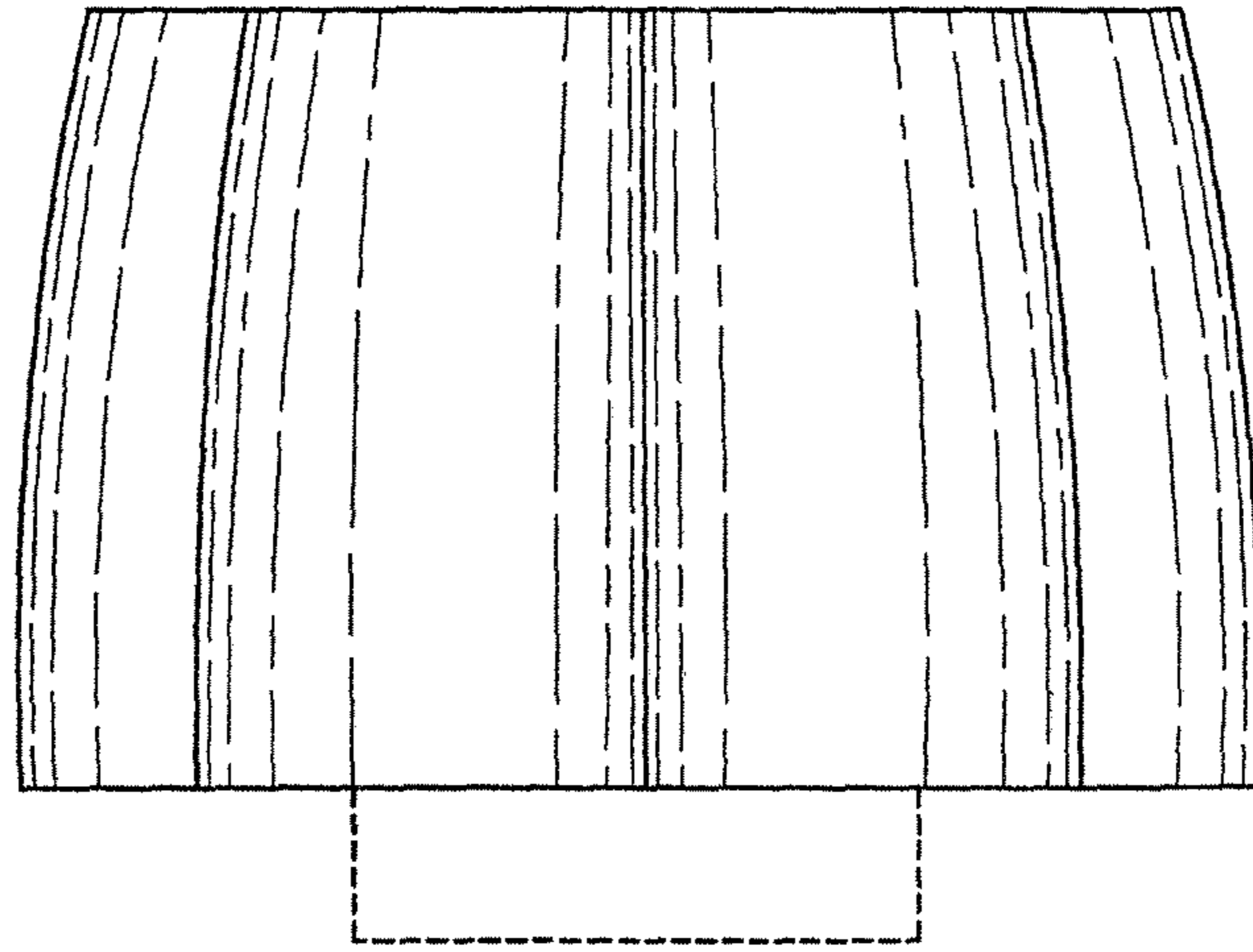

FIG. 4

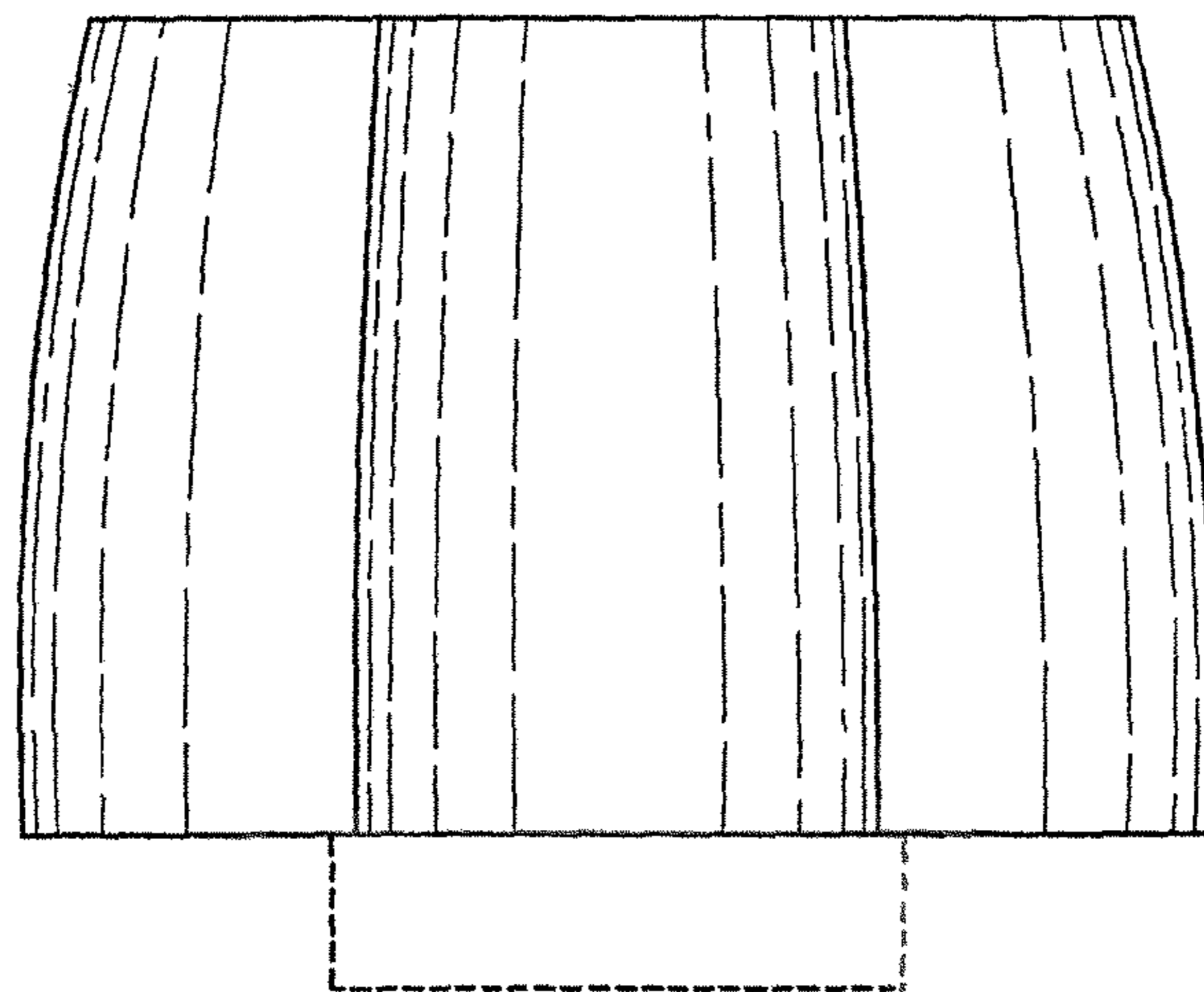

FIG. 5

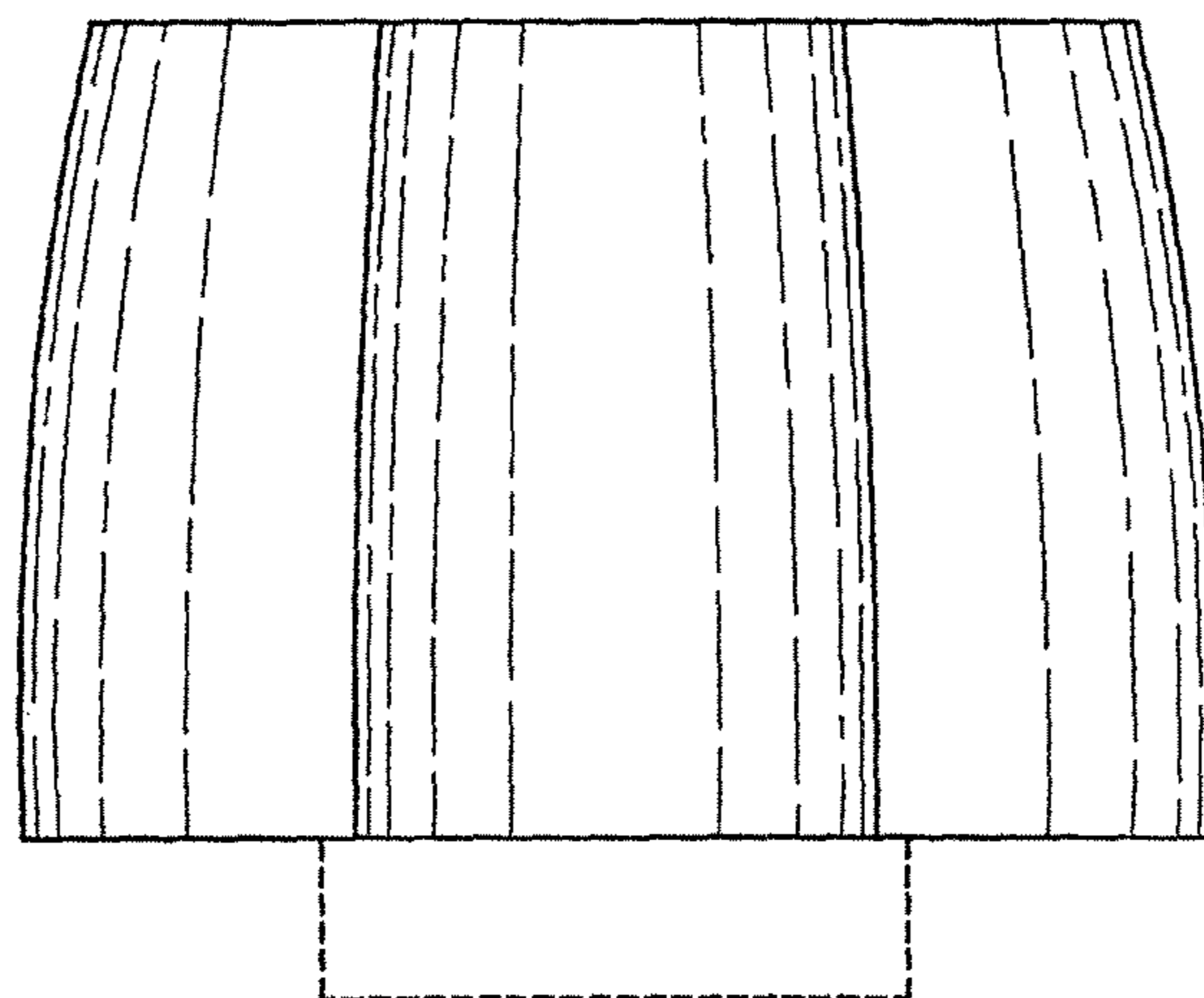

FIG. 6

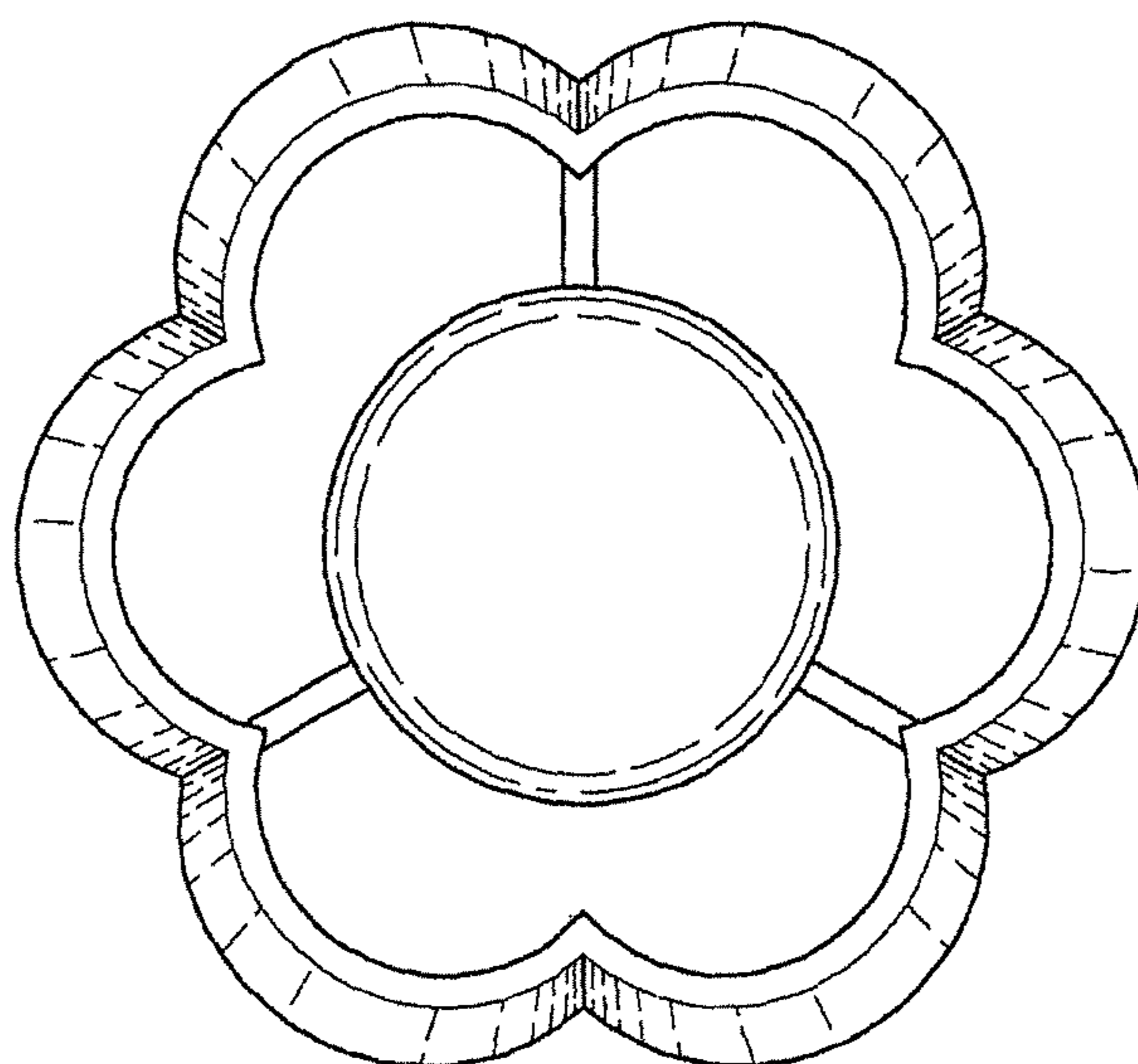

FIG. 7

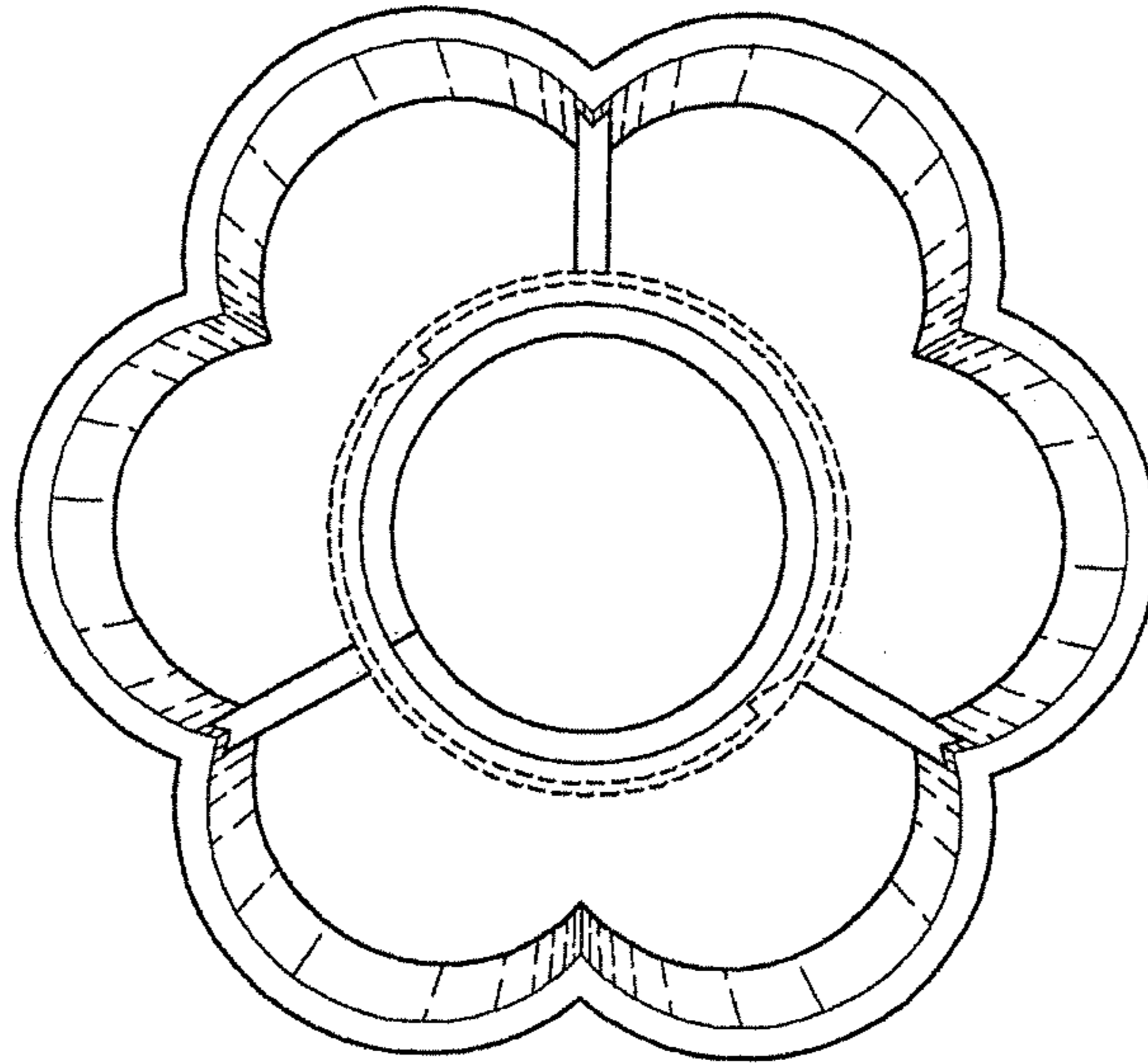

FIG. 8

