



US00D681452S

(12) **United States Design Patent**
Dennen et al.

(10) **Patent No.:** **US D681,452 S**

(45) **Date of Patent:** **** May 7, 2013**

(54) **PIZZA BOX**

(75) Inventors: **Robert P. Dennen**, Prosper, TX (US);
John Pesti, St. Charles, MO (US); **Owen Glock**, Valparaiso, IN (US)

(73) Assignee: **Pizza Hut, Inc.**, Plano, TX (US)

(**) Term: **14 Years**

(21) Appl. No.: **29/406,308**

(22) Filed: **Nov. 11, 2011**

(51) **LOC (9) Cl.** **09-03**

(52) **U.S. Cl.**
USPC **D9/433**

(58) **Field of Classification Search** D9/414,
D9/416, 418, 420-424, 430-433; D3/272,
D3/273, 302; 206/267, 269, 270, 273, 299,
206/737, 740, 822; 229/100, 101, 101.3,
229/106, 108-122, 122.3-123.3

See application file for complete search history.

(56) **References Cited**

U.S. PATENT DOCUMENTS

5,209,392 A * 5/1993 Anatro 229/117.01
D349,049 S * 7/1994 Gulliver D9/416
5,358,174 A * 10/1994 Antczak et al. 229/110
6,305,533 B1 * 10/2001 Welty et al. 206/278

6,851,603 B1 2/2005 Carlson et al.
D506,671 S * 6/2005 Tilley et al. D9/432
D510,264 S * 10/2005 Tilley et al. D9/432
7,051,919 B1 * 5/2006 Walsh 229/103
D542,647 S * 5/2007 Walter D9/414
D549,093 S * 8/2007 Weakland D9/420
2004/0222278 A1 * 11/2004 Correll 229/110

* cited by examiner

Primary Examiner — Susan Bennett Hattan

Assistant Examiner — Vy Koenig

(74) *Attorney, Agent, or Firm* — Stites & Harbison, PLLC;
David W. Nagle, Jr.

(57) **CLAIM**

The ornamental design for a pizza box, as shown and described.

DESCRIPTION

FIG. 1 is a perspective view of a pizza box incorporating the design of the present invention and with the lid open; FIG. 2 is another perspective view of the pizza box of FIG. 1 with the lid closed; FIG. 3 is a front view of the pizza box of FIG. 2; FIG. 4 is a rear view of the pizza box of FIG. 2; FIG. 5 is a left side view of the pizza box of FIG. 2; FIG. 6 is a right side view of the pizza box of FIG. 2; FIG. 7 is a top view of the pizza box of FIG. 2; and, FIG. 8 is a bottom view of the pizza box of FIG. 2.

1 Claim, 6 Drawing Sheets

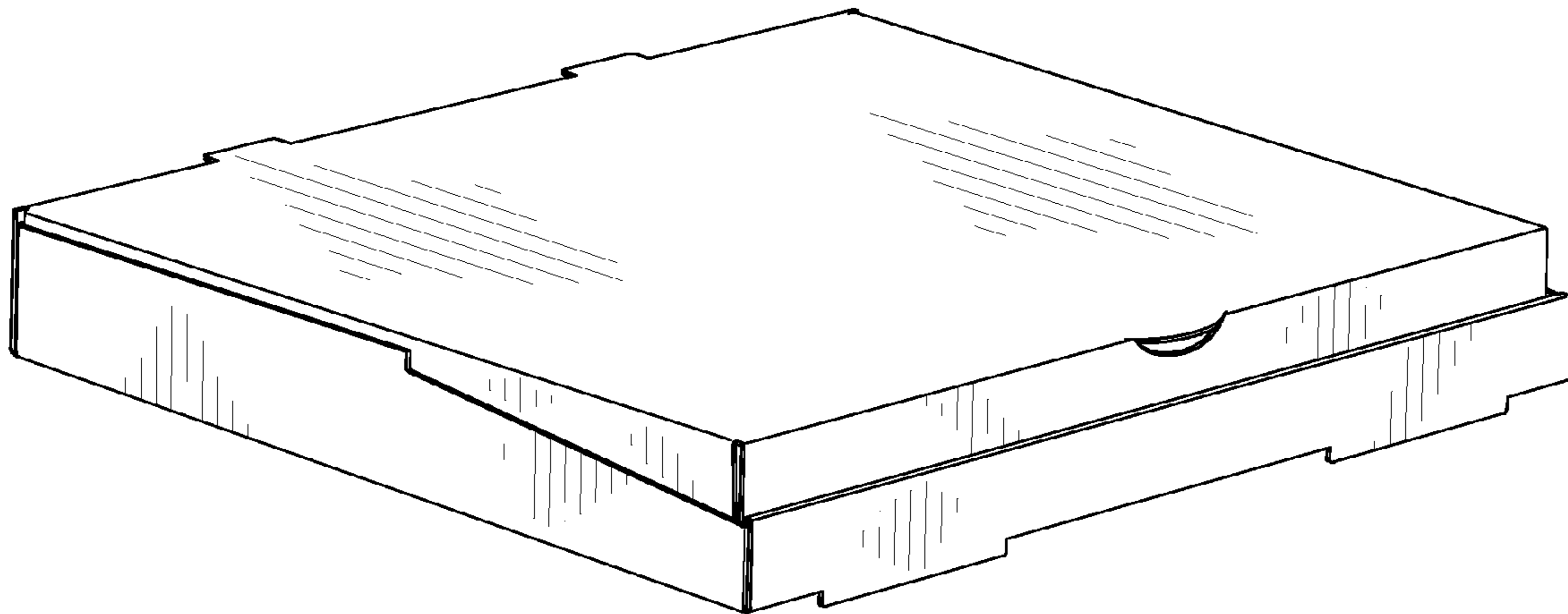

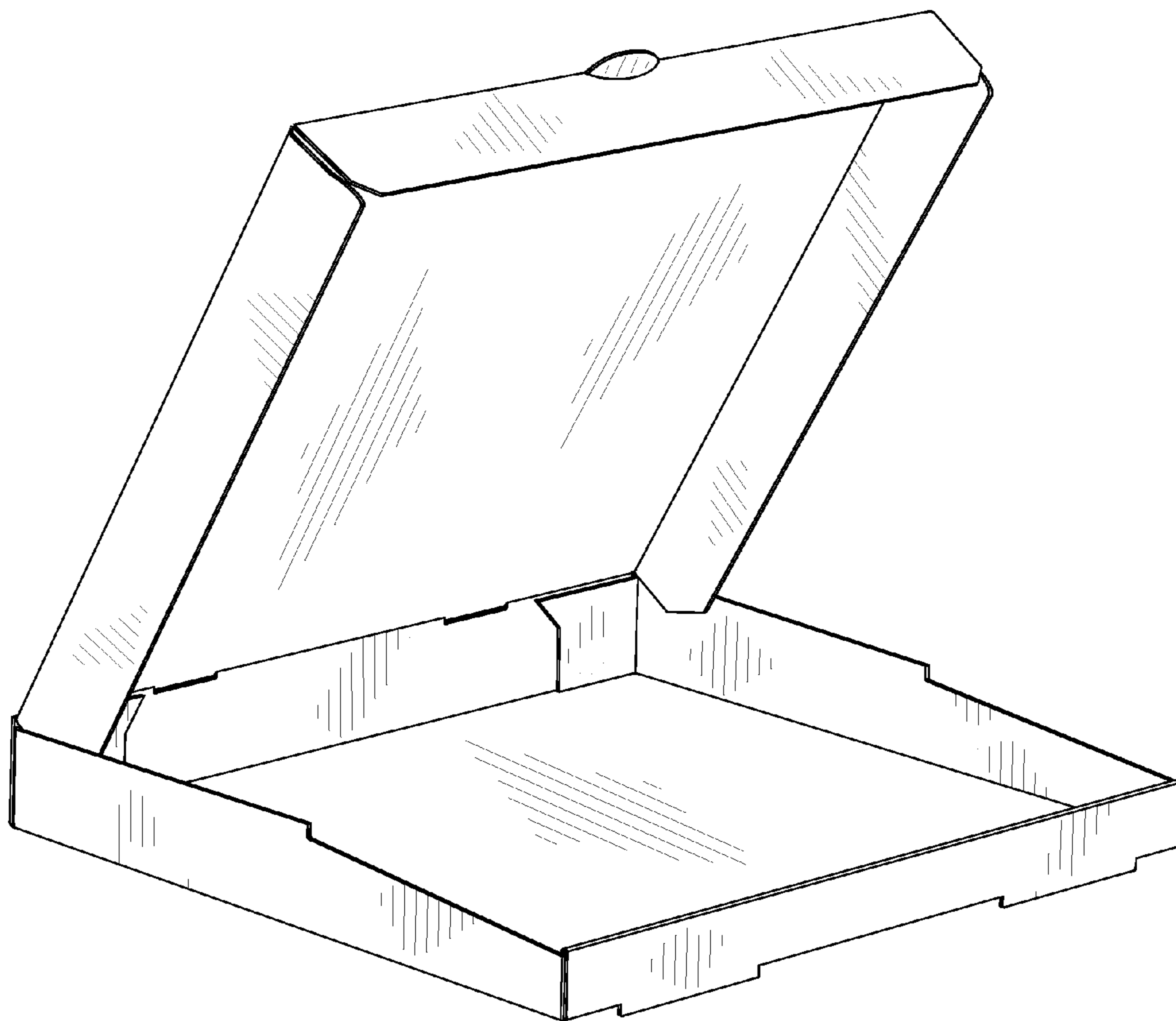

FIG. 1

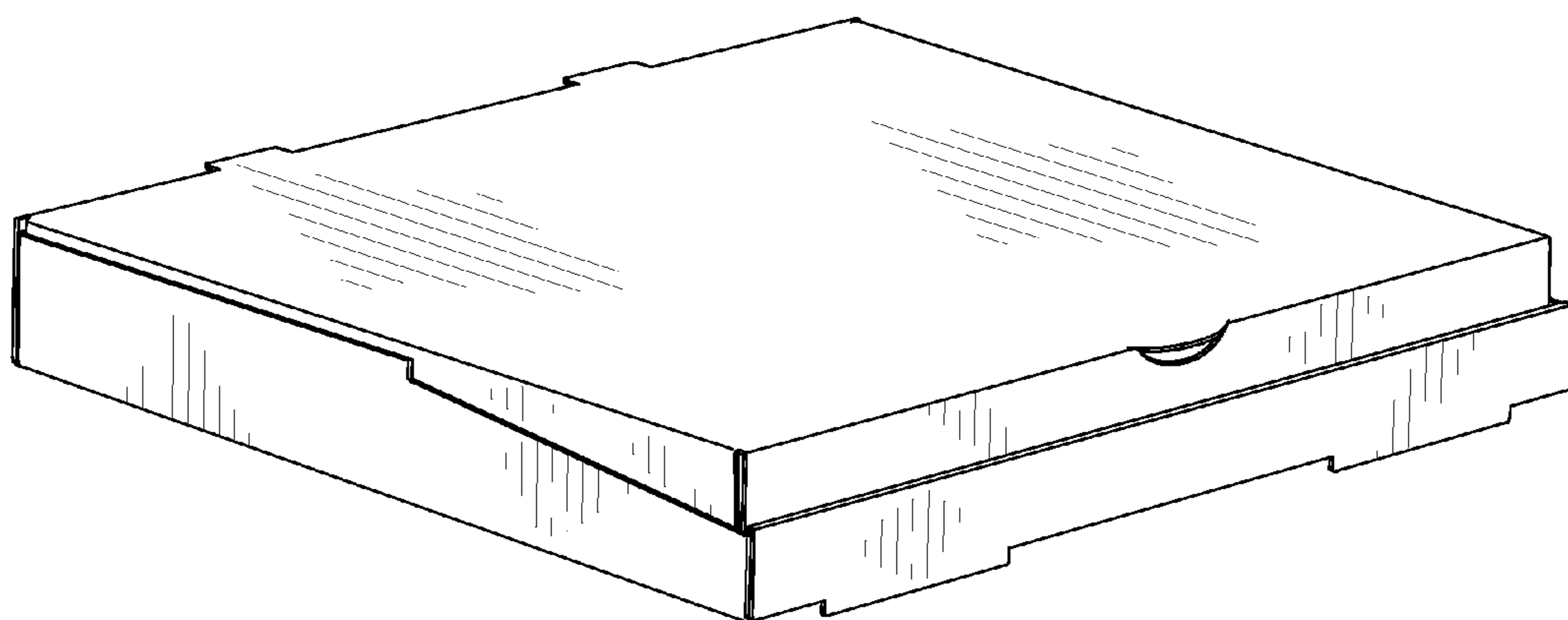

FIG. 2

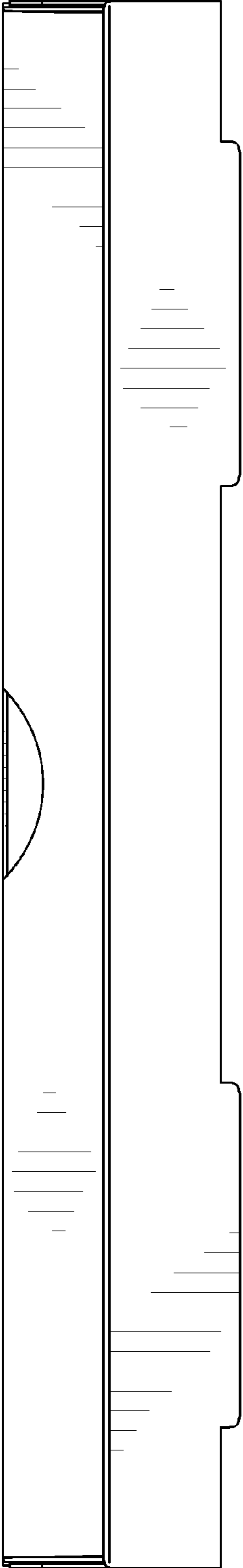

FIG. 3

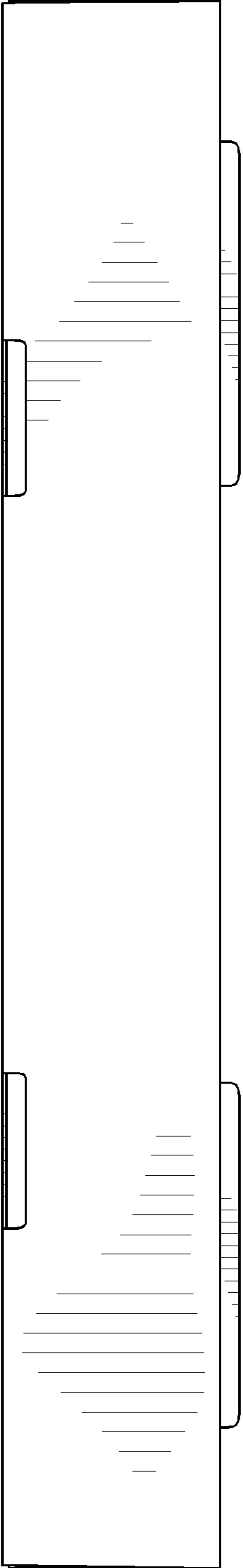

FIG. 4

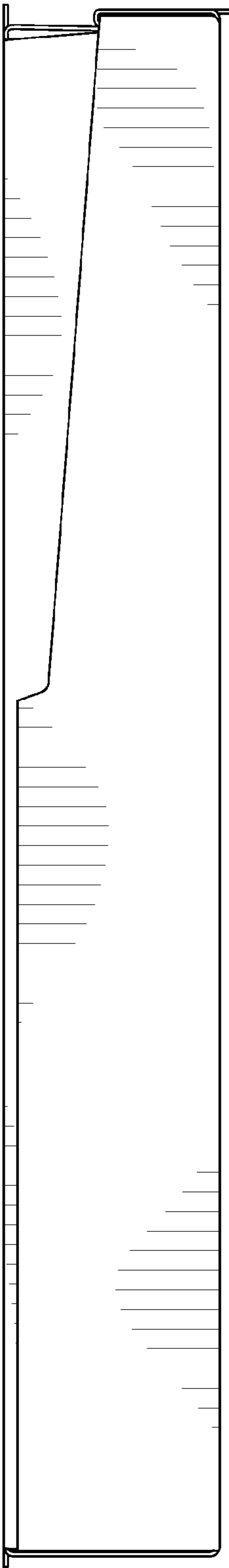

FIG. 5

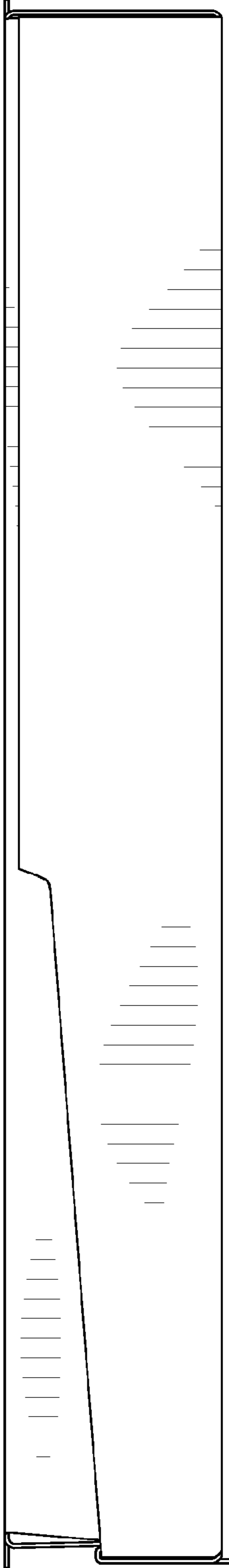

FIG. 6

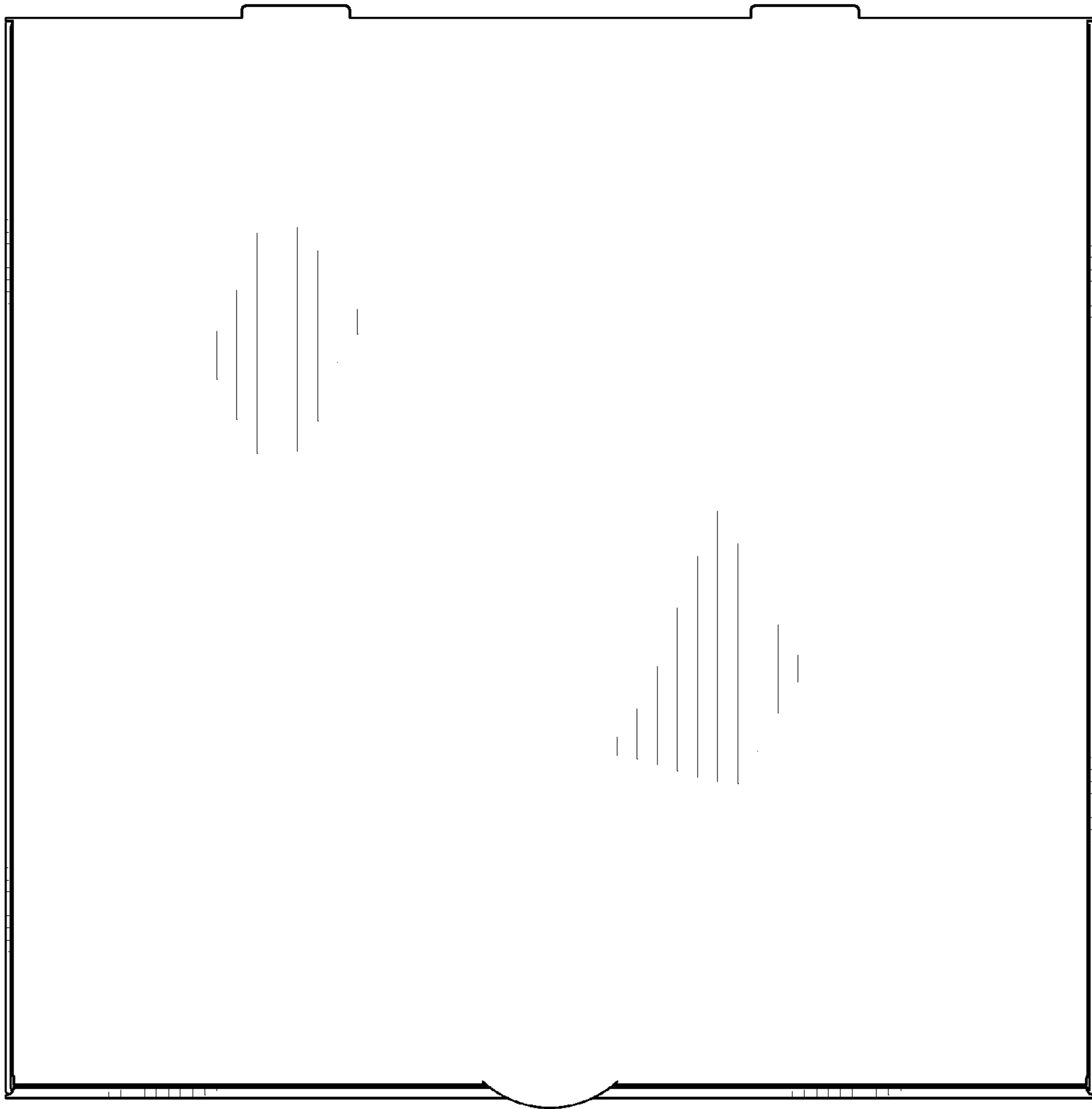

FIG. 7

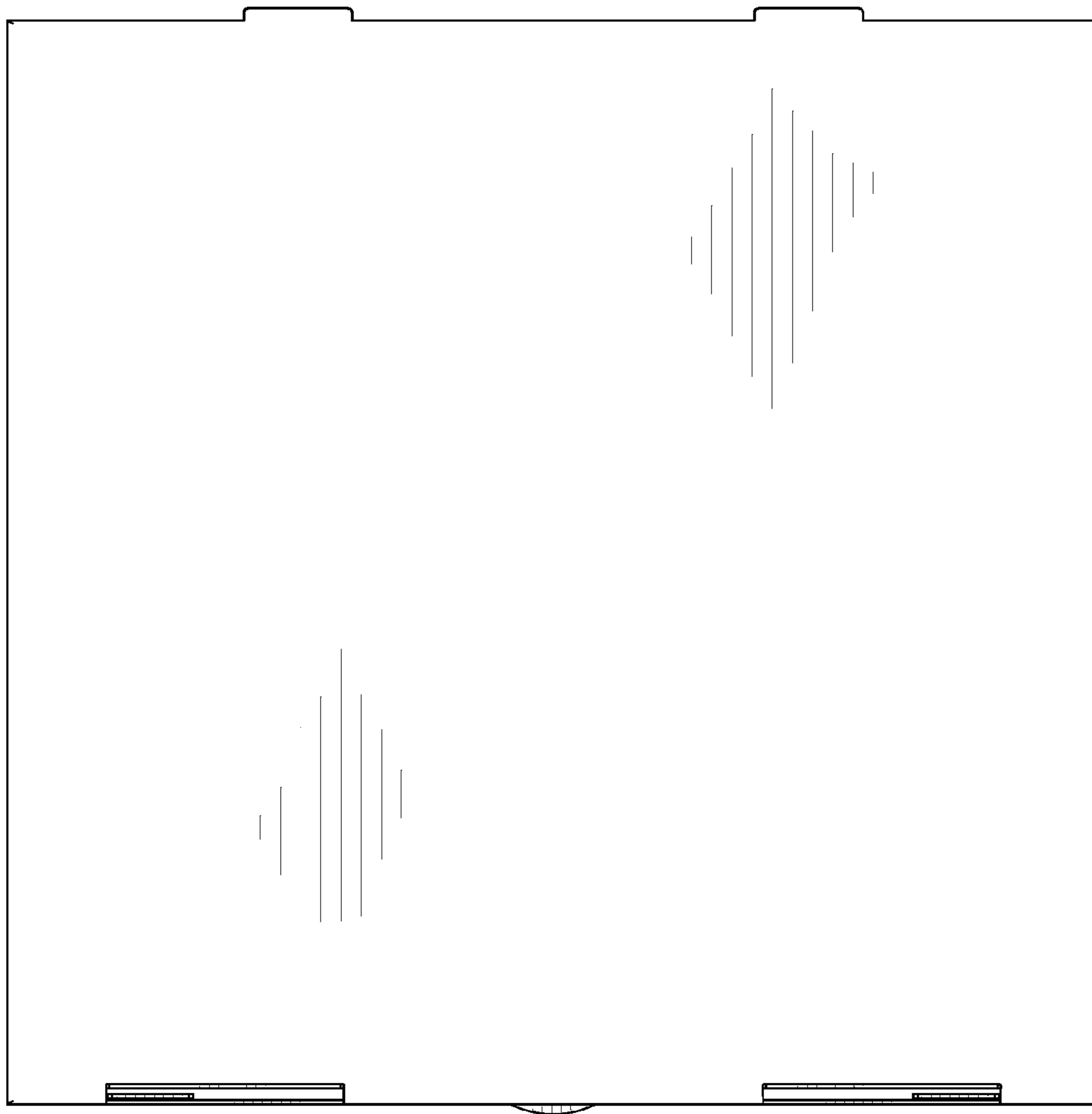

FIG. 8