



US00D681447S

(12) **United States Design Patent**
Schulter et al.

(10) **Patent No.:** **US D681,447 S**
(45) **Date of Patent:** **** May 7, 2013**

(54) **RECTANGULAR HINGED FOOD CONTAINER**

(75) Inventors: **Martin Schulter**, Greenbrae, CA (US);
Feng Yi Chen, Burlingame, CA (US)

(73) Assignee: **Nowpak Inc.**, Burlingame, CA (US)

(**) Term: **14 Years**

(21) Appl. No.: **29/424,624**

(22) Filed: **Jun. 13, 2012**

(51) **LOC (9) Cl.** **09-03**

(52) **U.S. Cl.**
USPC **D9/426; D9/420**

(58) **Field of Classification Search** D9/414,
D9/416, 424, 425, 430, 431, 432, 761; D7/538,
D7/549, 550.1, 601-603, 605, 629; 220/23.4,
220/23.6, 266, 281, 315, 318, 500, 659, 669,
220/674, 675, 696, 752, 760, 790, 793, DIG. 12,
220/FOR. 117; 229/105, 117.09, 117.26,
229/189, 406, 407, 902, 905, 915.1; 206/499,
206/508, 557; D3/276

See application file for complete search history.

(56) **References Cited**

U.S. PATENT DOCUMENTS

D363,879 S *	11/1995	Krupa et al.	D9/423
5,515,993 A *	5/1996	McManus	220/4.23
D407,014 S *	3/1999	McCann	D9/423
D439,160 S *	3/2001	Abayhan et al.	D9/429
D467,496 S	12/2002	Hayes et al.		
6,644,494 B2	11/2003	Hayes et al.		
7,124,910 B2	10/2006	Nordland		
D551,546 S *	9/2007	Ramirez et al.	D9/761
D572,582 S *	7/2008	Lymn et al.	D9/426
7,922,021 B2	4/2011	Golden		
D640,129 S *	6/2011	Sifuentes et al.	D9/425

(Continued)

OTHER PUBLICATIONS

Dart Container Corporation, ClearSeal® Freshness is a snap!, downloaded from <[http://www.dartcontainer.com/web/products.nsf/files/M-297.pdf/\\$FILE/M-297.pdf](http://www.dartcontainer.com/web/products.nsf/files/M-297.pdf/$FILE/M-297.pdf)>, "© 2011 Dart Container Corporation," 2 pages.

(Continued)

Primary Examiner — Thomas Johannes

(74) *Attorney, Agent, or Firm* — Davidson Law Group, A Law Corporation

(57) **CLAIM**

The ornamental design for a rectangular hinged food container, as shown and described.

DESCRIPTION

FIG. 1 is a side perspective view of a hinged food container showing my new design in a closed configuration.

FIG. 2 is a top plan view of the hinged food container of FIG. 1.

FIG. 3 is a bottom plan view of the hinged container of FIG. 1.

FIG. 4 is a front elevational view of the hinged container of FIG. 1.

FIG. 5 is a rear elevational view of the hinged container of FIG. 1.

FIG. 6 is a left side elevational view of the hinged container of FIG. 1. The right side elevational view is a mirror image of the left side elevational view of the hinged container.

FIG. 7 is a side perspective view of a hinged container in an open configuration.

FIG. 8 is a top plan view of the hinged food container of FIG. 2.

FIG. 9 is a side perspective view of a hinged food container in a partially open configuration; and,

FIG. 10 is a right side elevational view of the hinged food container of FIG. 9.

1 Claim, 9 Drawing Sheets

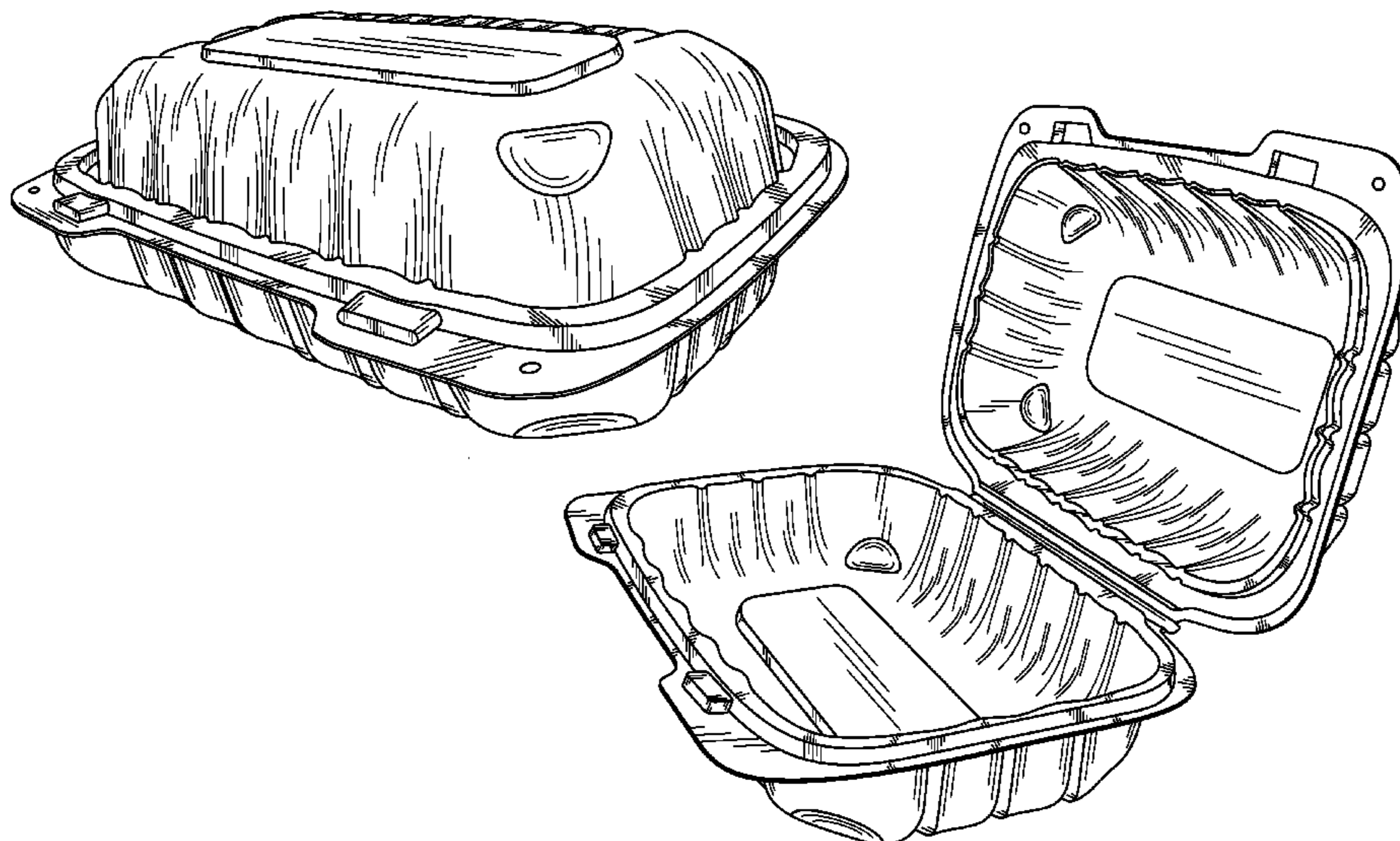

U.S. PATENT DOCUMENTS

D640,544 S * 6/2011 Sifuentes et al. D9/425
D668,537 S * 10/2012 Sanfilippo D9/425
D672,644 S * 12/2012 Allers et al. D9/423
2010/0320210 A1* 12/2010 Cimmerer et al. 220/367.1

OTHER PUBLICATIONS

Dart Container Corporation, StayLock® Clear Hinged Lid Containers, downloaded from <[http://www.dartcontainer.com/web/products.nsf/files/M-299.pdf/\\$FILE/M-299.pdf](http://www.dartcontainer.com/web/products.nsf/files/M-299.pdf/$FILE/M-299.pdf)>, “© 2010 Dart Container Corporation,” 2 pages.

Pactiv Corporation, EarthChoice™ SmartLock® Hinged Lid Containers, downloaded from <http://www.pactiv.com/Products_NA/Foodservice/data/EarthChoice.pdf>, “© Pactiv Corporation 2008,” 2 pages.

Pactiv Corporation, ClearView™ SmartLock® Dual Color & Clear Containers, downloaded from <[NA/Foodservice/data/ClearView_SmartLock_DC-Clear_Hinges.pdf>, “© Pactiv Corporation 2009,” 4 pages.](http://www.pactiv.com/Products_</p></div><div data-bbox=)

Sol-Pak, Inc., 8" Clear Hinged Container, 2¾" deep—(deep base/shallow lid), downloaded from <http://www.sol-pak.com/sp_catalog/chc8x2/>, “Copyright © 2010-2012 Sol-Pak, Inc.,” 1 page.

Sol-Pak, Inc., 8" Clear Hinged Container, 2¾" deep—3 Compartment, downloaded from <http://www.sol-pak.com/sp_catalog/chc8x2d/>, “Copyright © 2010-2012 Sol-Pak, Inc.,” 1 page.

Sol-Pak, Inc., Packaging That Makes Good Things Better, downloaded from <<http://www.scribd.com/doc/52265454/SolpakCatalogPrint8-Final>>, “Upload Date: Apr. 4, 2011,” 2 pages.

Sol-Pak, Inc., Hinged Food Containers, p. 1 of 2, downloaded from <http://www.sol-pak.com/product_lines/hinged-food-containers/>, downloaded on Nov. 9, 2012, 5 pages.

Sol-Pak, Inc., Hinged Food Containers, p. 2 of 2, downloaded from <http://www.sol-pak.com/product_lines/hinged-food-containers/>, downloaded on Nov. 9, 2012, 4 pages.

* cited by examiner

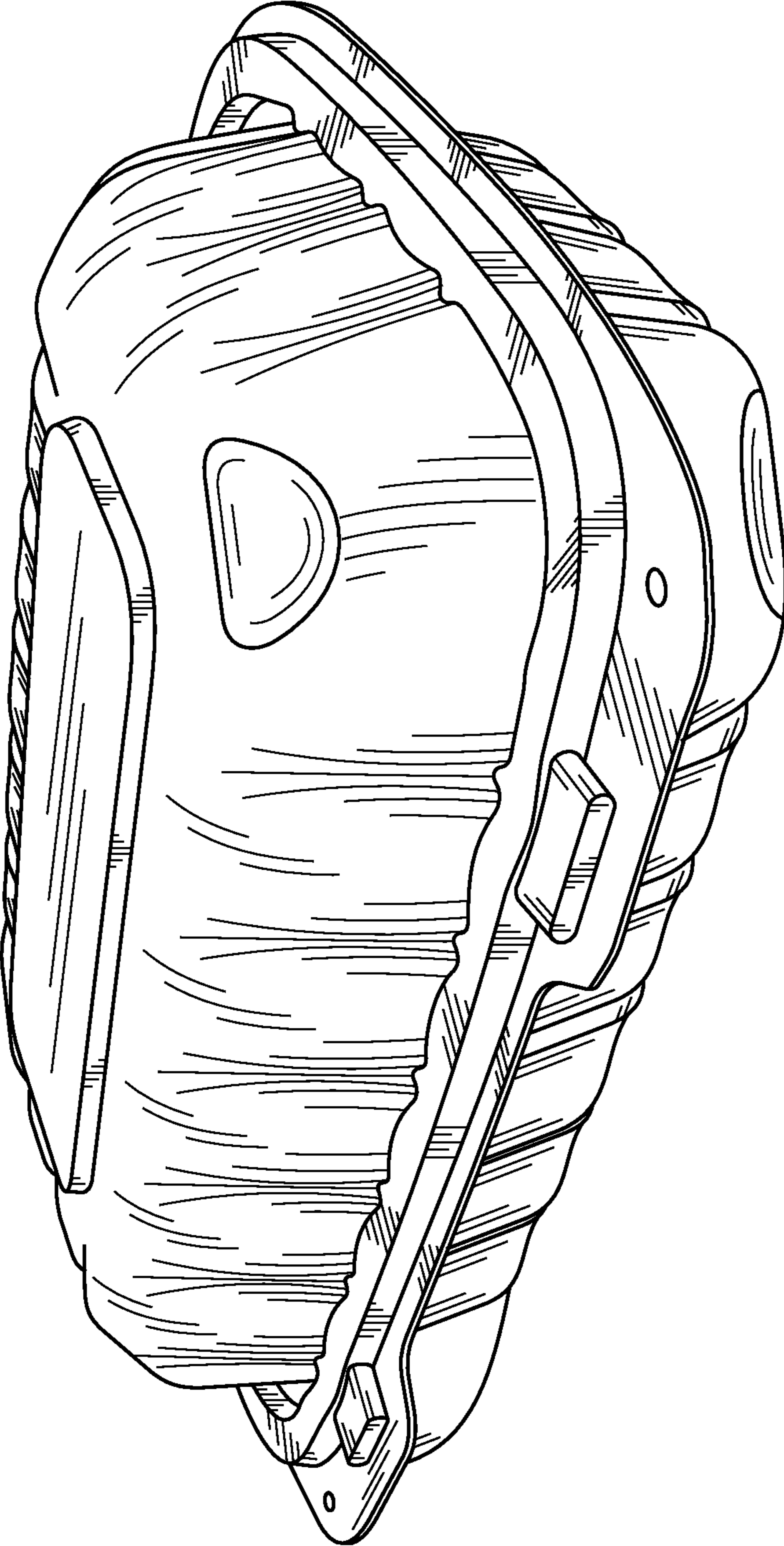

FIG. 1

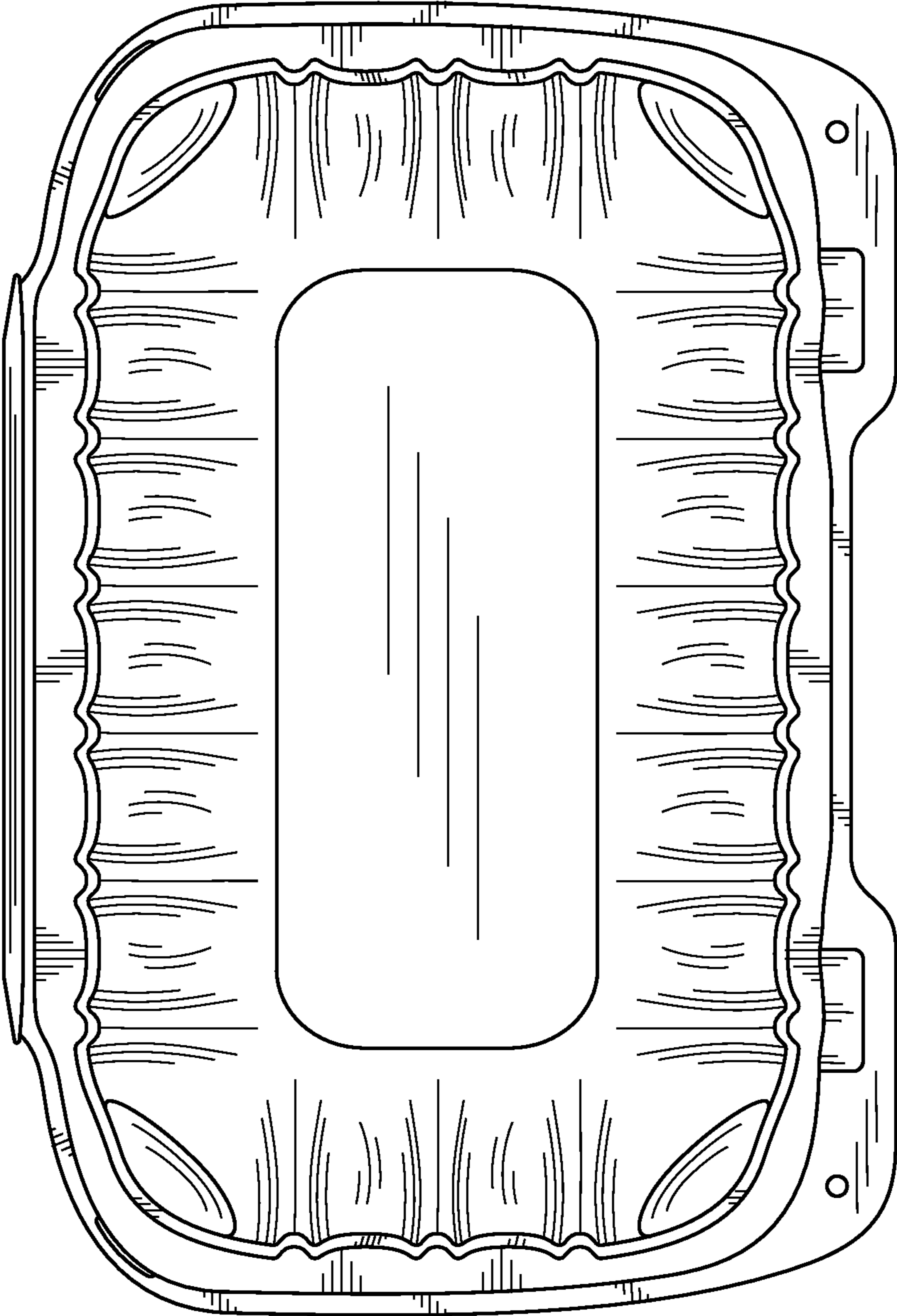

FIG. 2

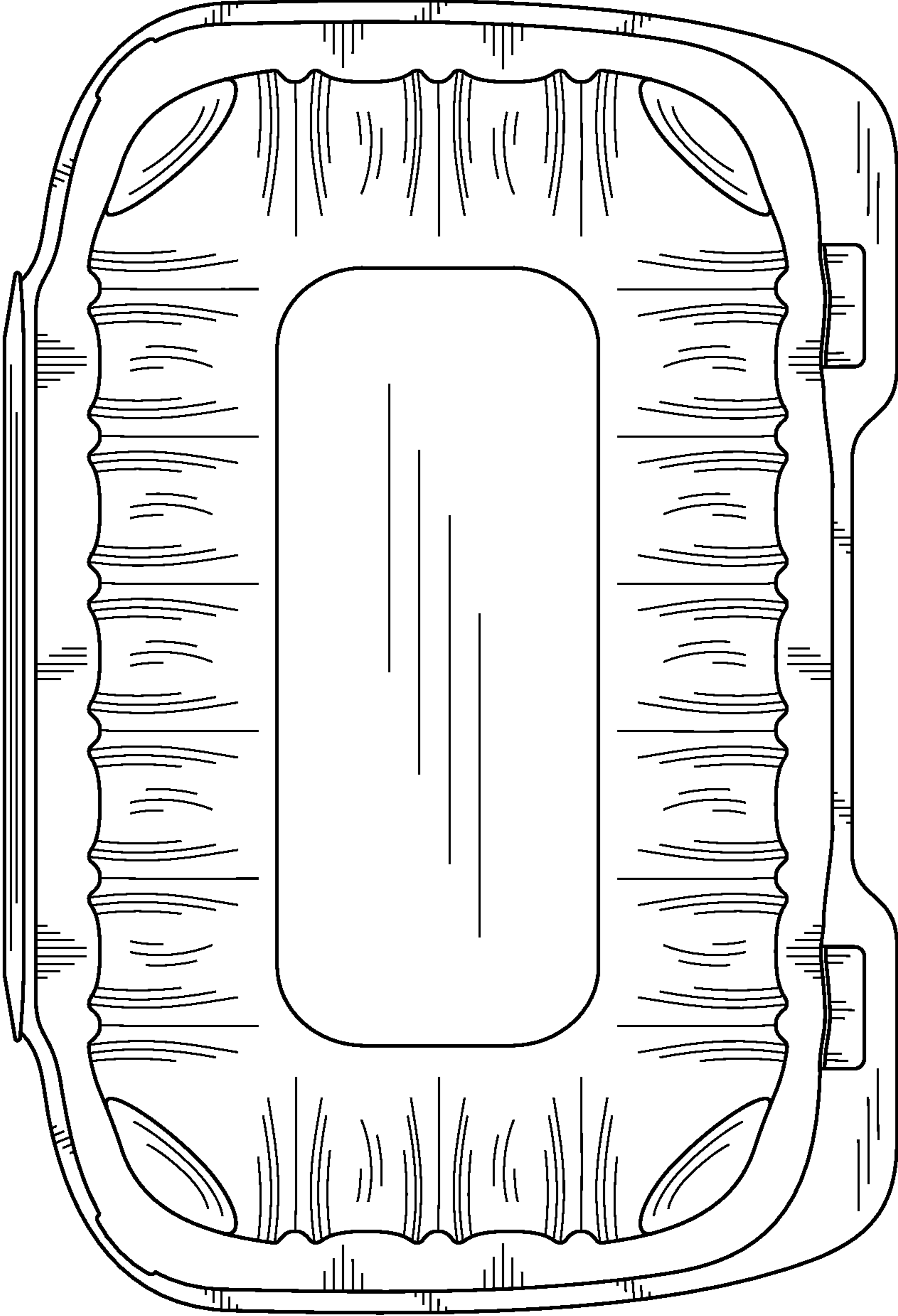

FIG. 3

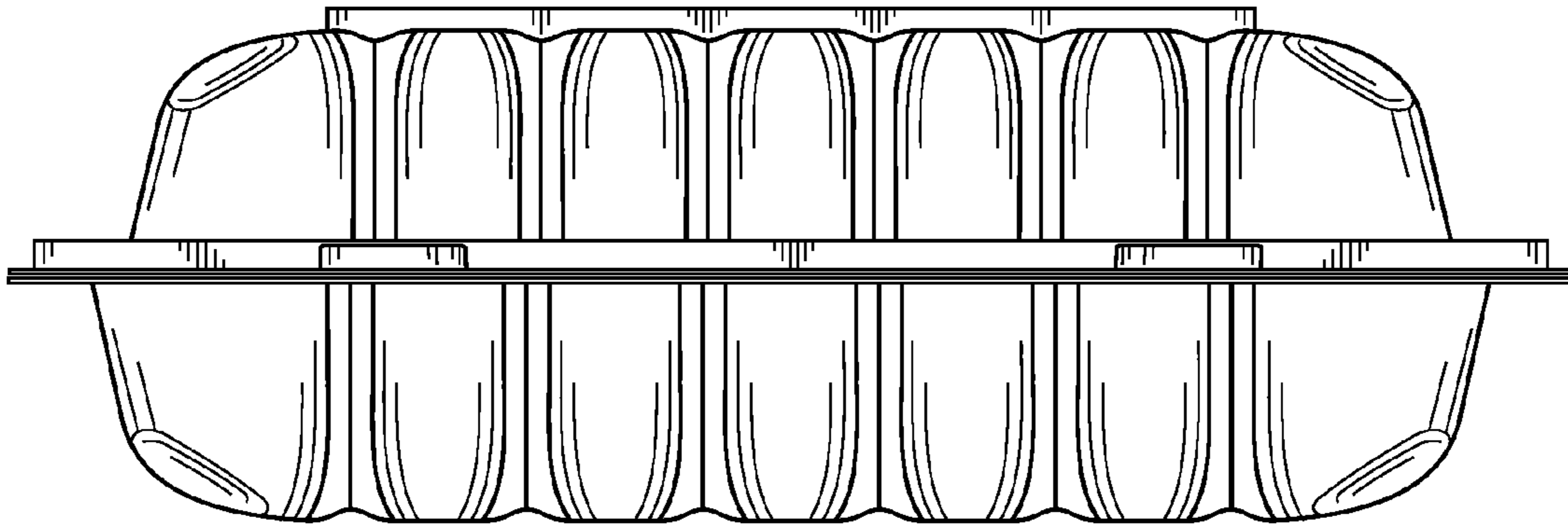

FIG. 4

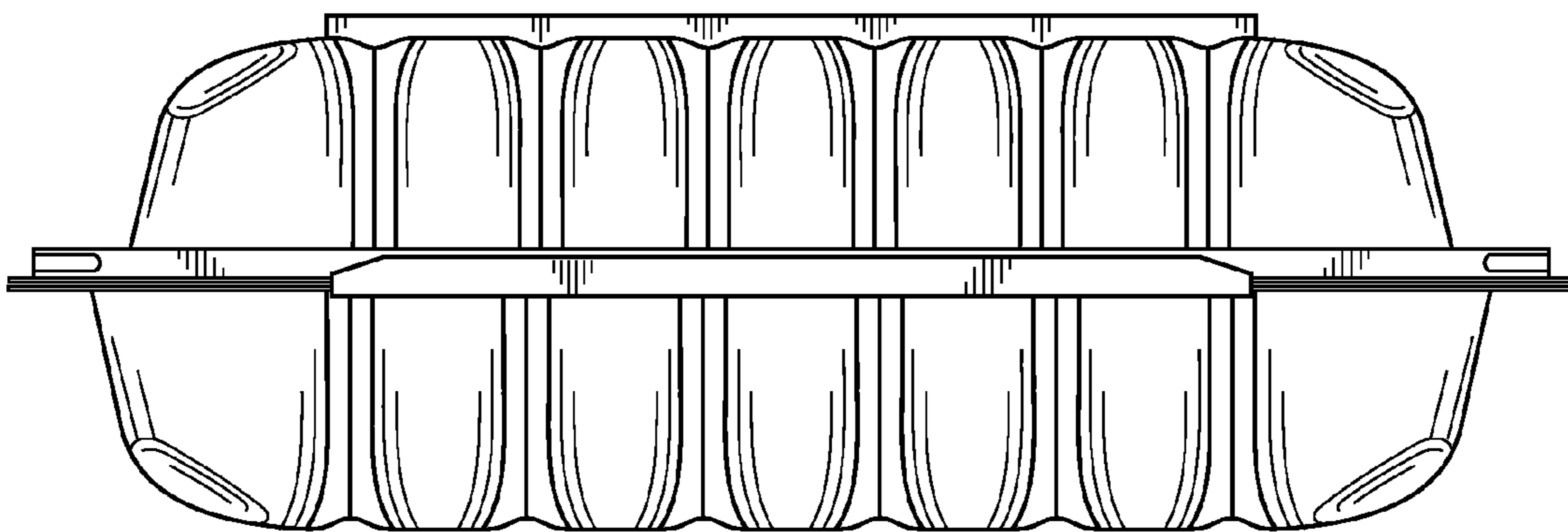

FIG. 5

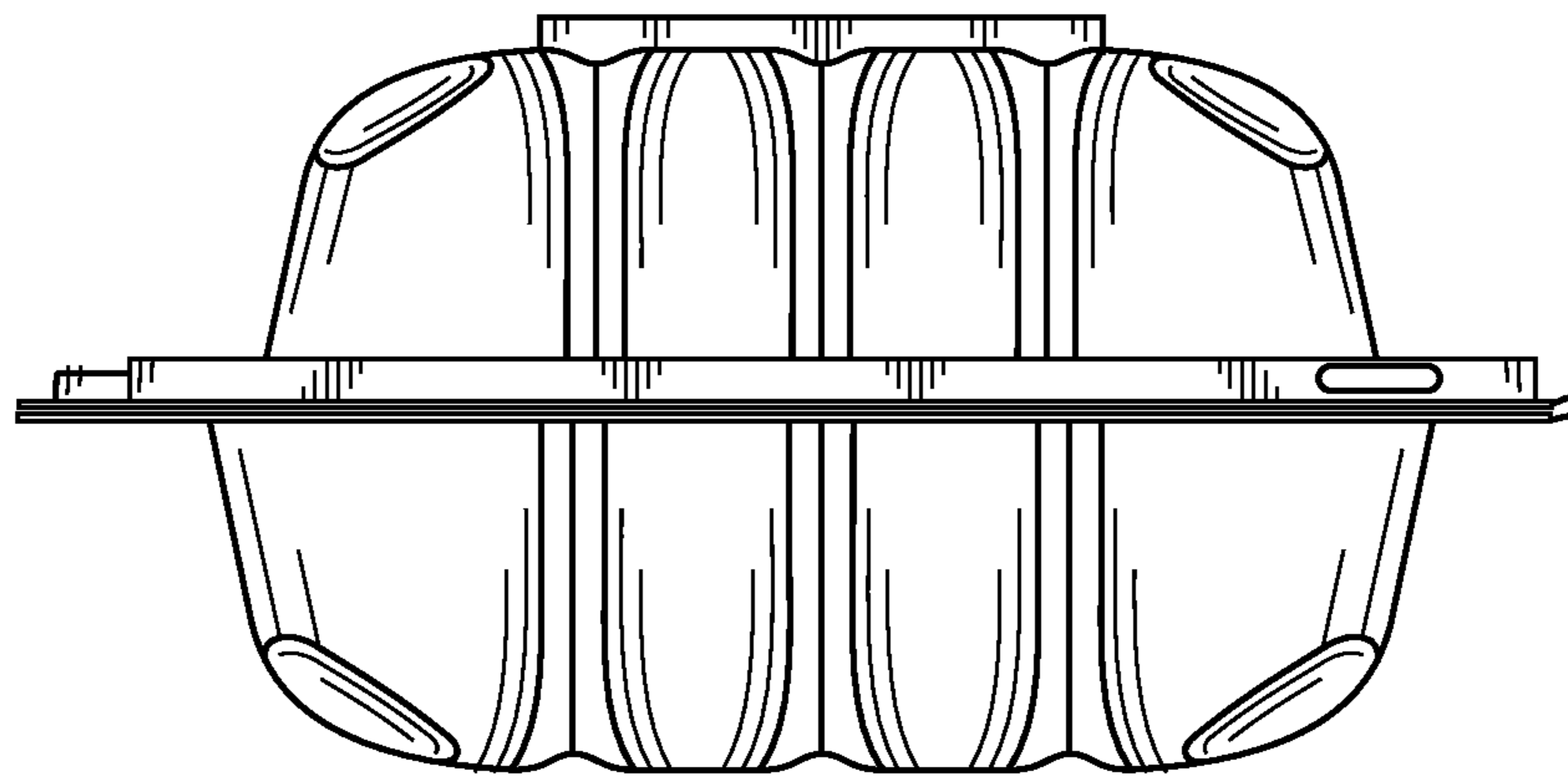

FIG. 6

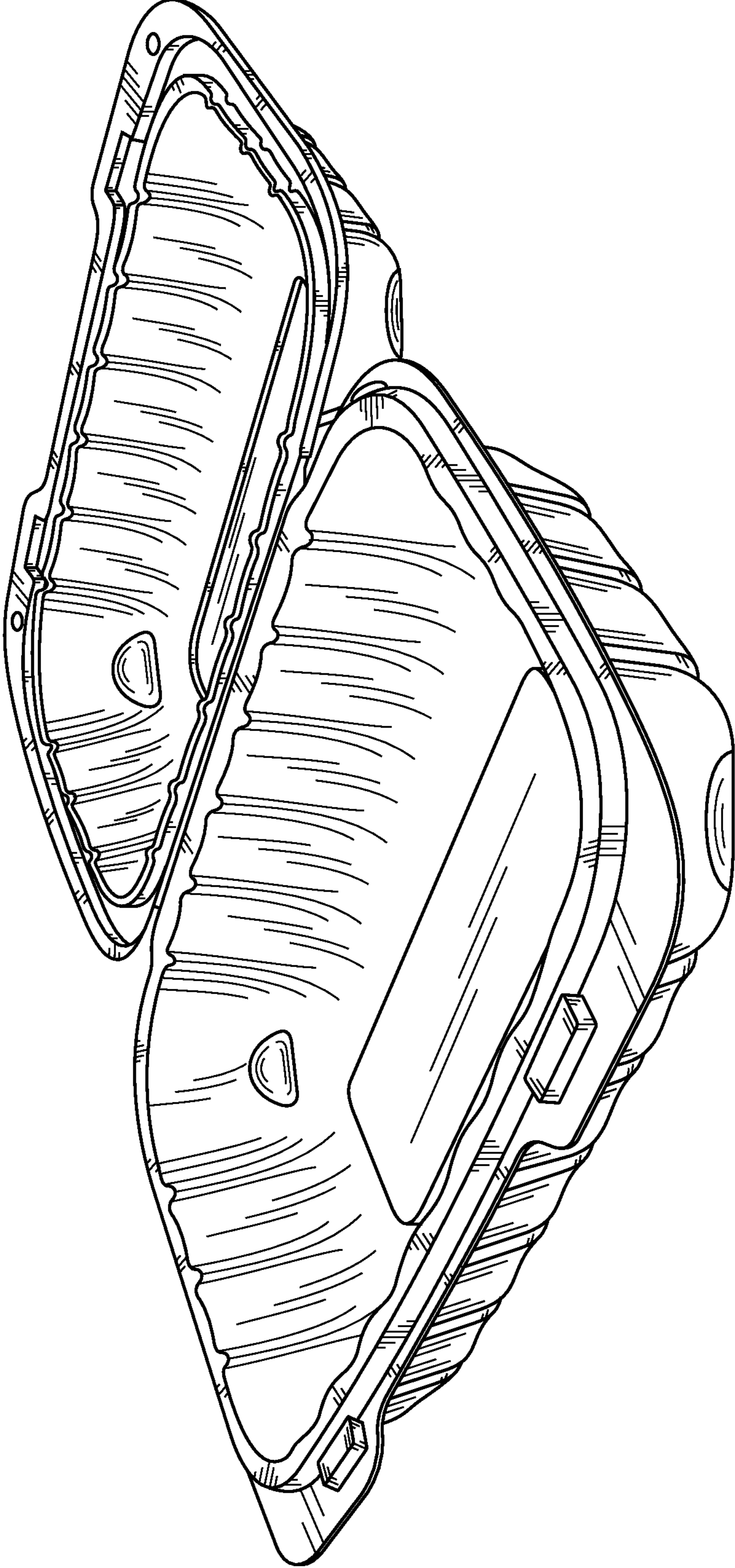

FIG. 7

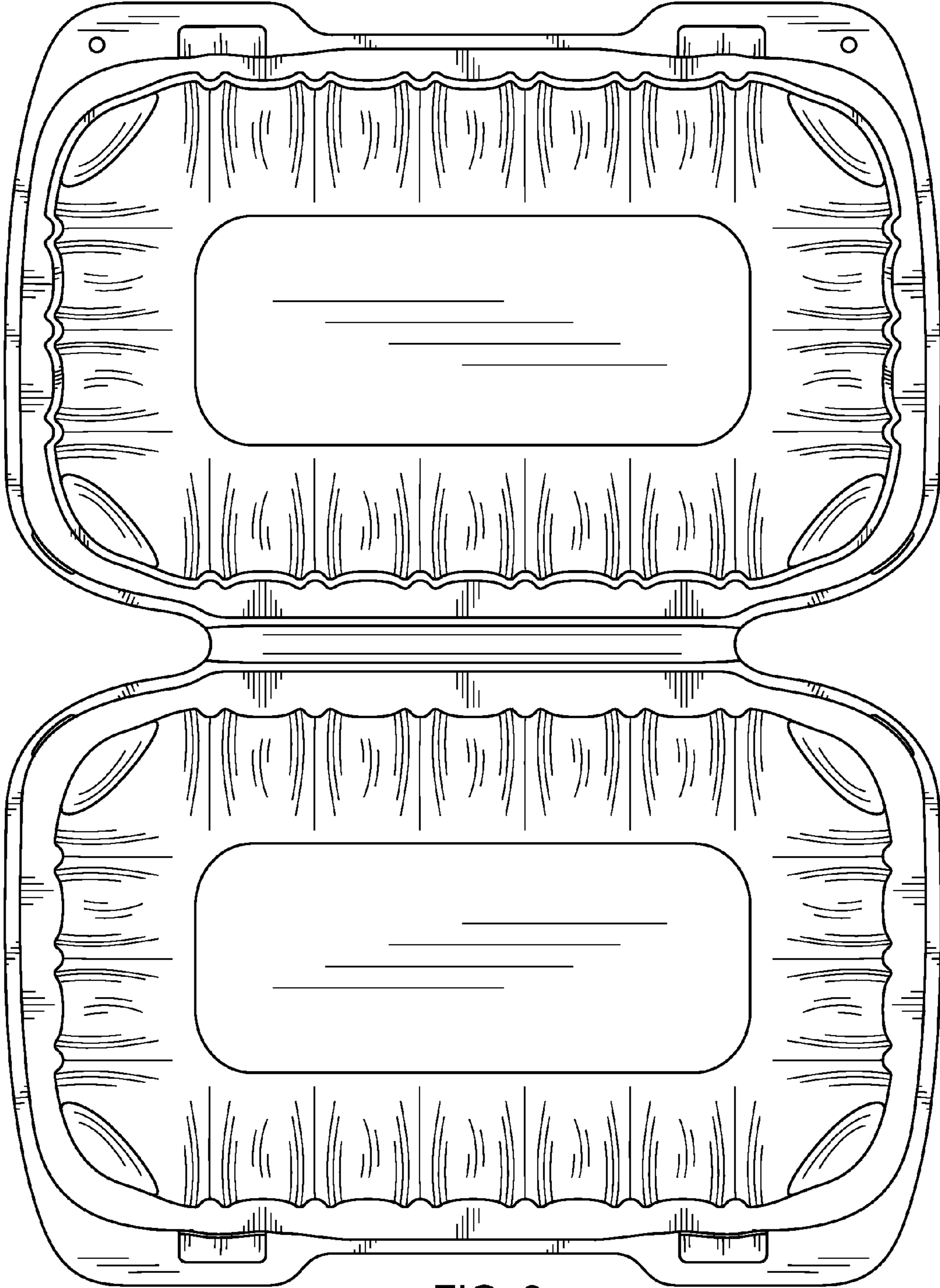

FIG. 8

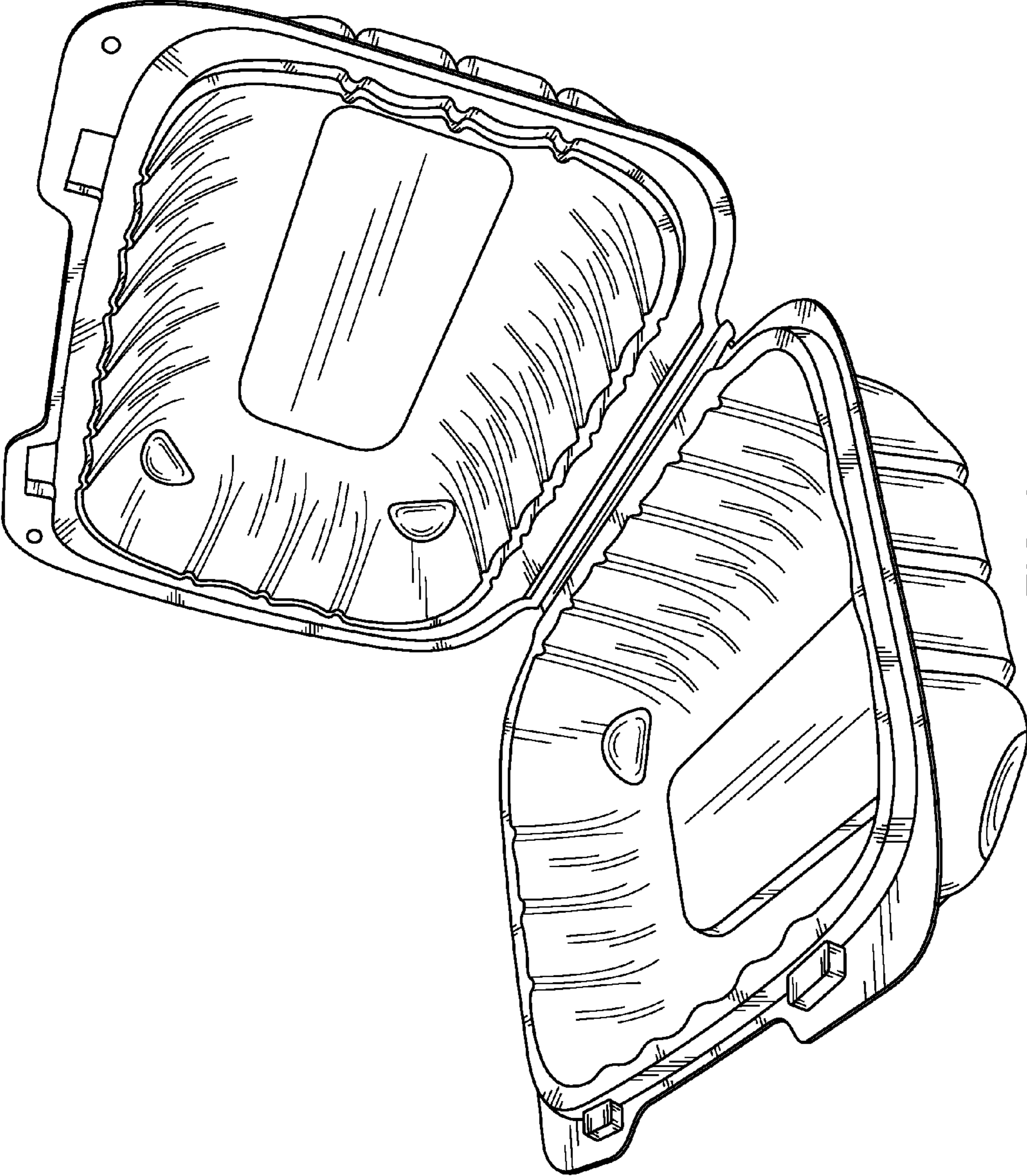

FIG. 9

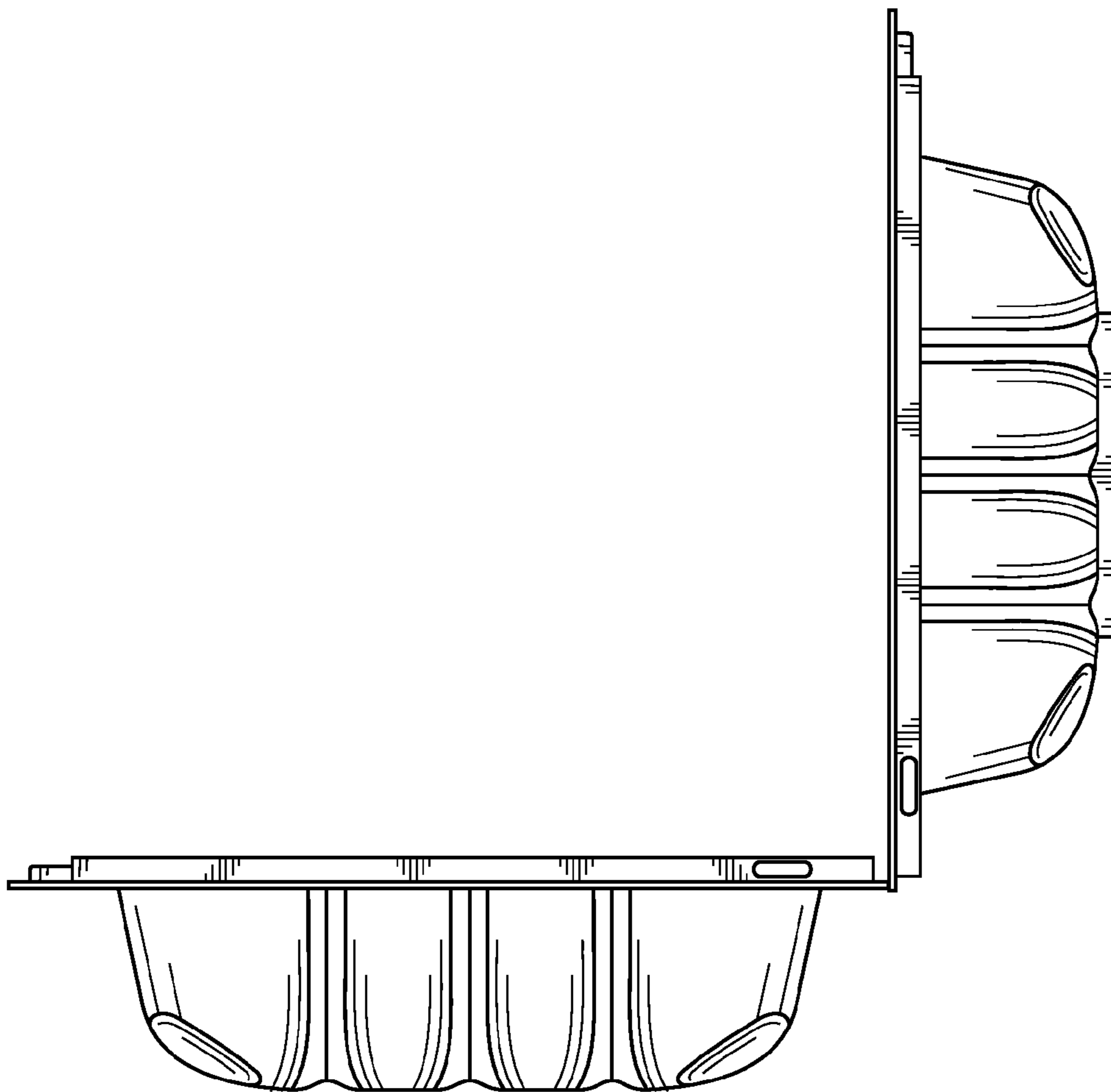

FIG. 10