



US00D681444S

(12) **United States Design Patent**
Oja et al.

(10) **Patent No.:** **US D681,444 S**
(45) **Date of Patent:** **** May 7, 2013**

(54) **PACKAGING**

(75) Inventors: **Mari-Annika Oja**, Helsinki (FI); **Mika Mattila**, Tampere (FI); **Oliverio Cruz-Diaz**, Tampere (FI)

(73) Assignee: **Nokia Corporation** (FI)

(**) Term: **14 Years**

(21) Appl. No.: **29/422,073**

(22) Filed: **May 16, 2012**

(51) **LOC (9) Cl.** **09-03**

(52) **U.S. Cl.**
USPC **D9/418**

(58) **Field of Classification Search** D9/415,
D9/418, 501, 72, 739, 742, 753
See application file for complete search history.

(56) **References Cited**

U.S. PATENT DOCUMENTS

D326,814	S	*	6/1992	Arai	D9/415
D373,308	S	*	9/1996	Chapman et al.	D9/415
D436,531	S	*	1/2001	Holmes et al.	D9/418
D437,778	S	*	2/2001	Voden et al.	D9/418
D497,547	S	*	10/2004	Kumakura et al.	D9/415
D509,442	S	*	9/2005	Several	D9/756
D586,651	S	*	2/2009	Klauder et al.	D9/418
D615,401	S	*	5/2010	Ouimette et al.	D9/457
D651,512	S	*	1/2012	Eaton et al.	D9/435
D652,321	S	*	1/2012	Melnick	D9/721
D656,008	S	*	3/2012	Meech et al.	D9/415
D658,055	S	*	4/2012	Kurita et al.	D9/415
2007/0108285	A1		5/2007	Lapstun et al.		

OTHER PUBLICATIONS

<http://www.products-suppliers.com/product-info/651654/clear-plastic-PP-PET-PVC-hang> . . . searched RMS Nov. 21, 2012.* <http://www.shutterstock.com/pic-94641040/stock-vector-box-with-shel-display-hanger.ht> . . . searched RMS Nov. 21, 2012.*
Illustration—Gears. Vector packaging box. Abstract Illustration. “http://ww.123rf.com/photo_9409242_gears-vector-packaging-box-abstract-illustration.html” date unknown but prior to the filing date of current application.

Mobile Phone Boxes. “<http://skateandannoy.com/2006/10/mobile-phone-boxes/>” date unknown but prior to the filing date of current application.

Cosmetic Packaging—Cosmetic Box Printing(PP-0012) “<http://chinese-printing.en.made-in-china.com/product/XqREoAwUJfDY/China-Cosmetic-Packaging-Cosmetics-Box-Printing-PP-0012-.html>” Oct. 26, 2006.

Mobile Phone Packaging Box (XC-3337) <http://xiancaiprinting.en.made-in-china.com/offer/jbmJHBdVEDWI/Sell-Moble-Phone-Packaging-Box-XC-337-.html> date unknown but prior to the filing date of current application.

Corrugated Cardboard “<http://www.madehow.com/Volume-1/Corrugated-Cardboard.html>” date unknown but prior to the filing date of the current application.

* cited by examiner

Primary Examiner — Robert M Spear

Assistant Examiner — Rhea Shields

(74) *Attorney, Agent, or Firm* — Banner & Witcoff, Ltd.

(57) **CLAIM**

The ornamental design for packaging, as shown and described.

DESCRIPTION

FIG. 1 is a perspective view of packaging showing our new design;

FIG. 2 is a front view thereof;

FIG. 3 is a rear view thereof;

FIG. 4 is a left side view thereof;

FIG. 5 is a right side view thereof;

FIG. 6 is a top view thereof;

FIG. 7 is a bottom view thereof;

FIG. 8 is a perspective view of packaging showing our new design;

FIG. 9 is a front view thereof;

FIG. 10 is a rear view thereof;

FIG. 11 is a left side view thereof;

FIG. 12 is a right side view thereof;

FIG. 13 is a top view thereof;

FIG. 14 is a bottom view thereof;

FIG. 15 is a perspective view of packaging showing our new design;

FIG. 16 is a front view thereof;

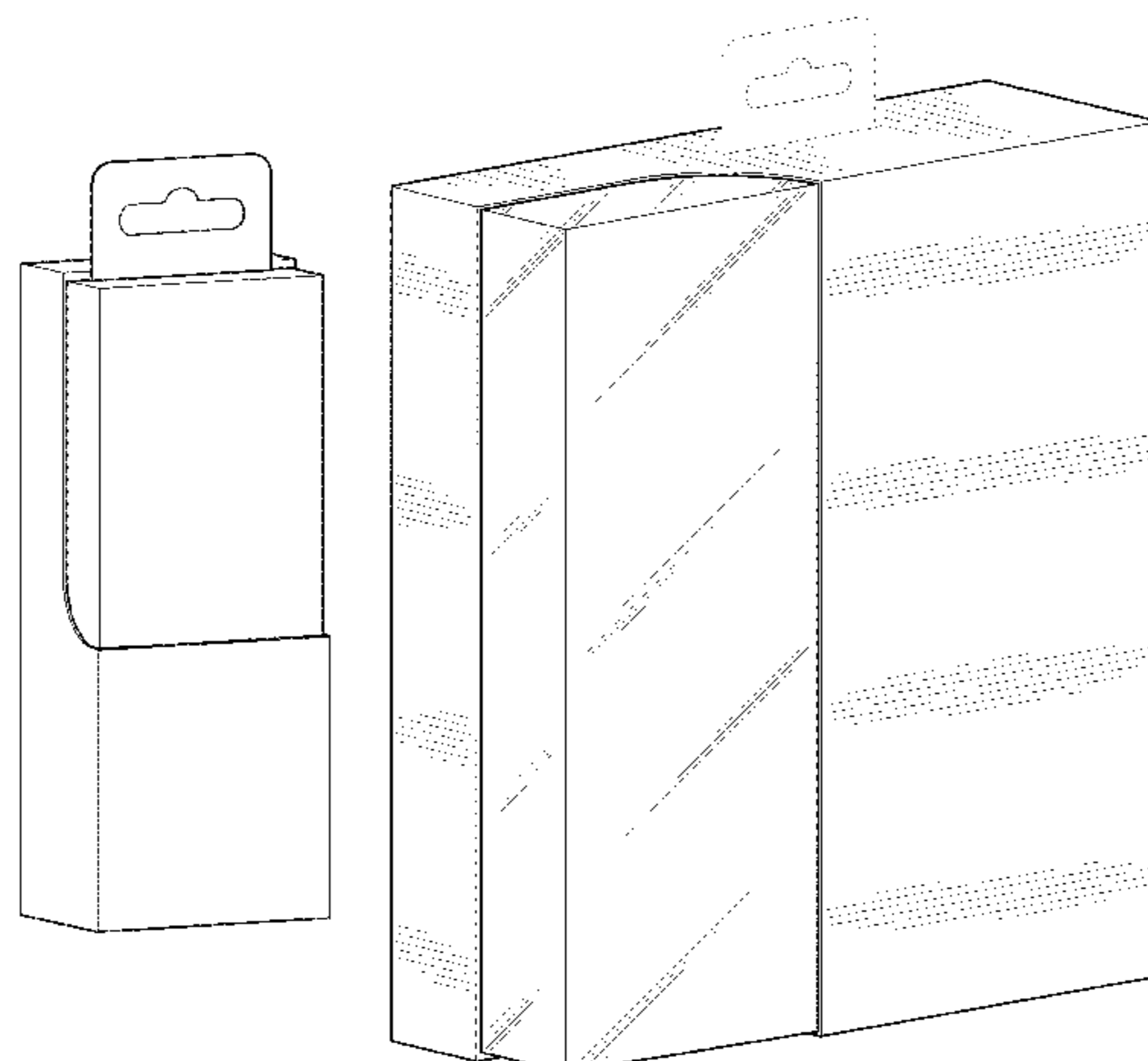

FIG. 17 is a rear view thereof;
FIG. 18 is a left side view thereof;
FIG. 19 is a right side view thereof;
FIG. 20 is a top view thereof;
FIG. 21 is a bottom view thereof;
FIG. 22 is a perspective view of packaging showing our new design;
FIG. 23 is a front view thereof;
FIG. 24 is a rear view thereof;
FIG. 25 is a left side view thereof;
FIG. 26 is a right side view thereof;
FIG. 27 is a top view thereof;
FIG. 28 is a bottom view thereof;
FIG. 29 is a perspective view of packaging showing our new design;
FIG. 30 is a front view thereof;
FIG. 31 is a rear view thereof;
FIG. 32 is a left side view thereof;
FIG. 33 is a right side view thereof;
FIG. 34 is a top view thereof;
FIG. 35 is a bottom view thereof;
FIG. 36 is a perspective view of packaging showing our new design;
FIG. 37 is a front view thereof;
FIG. 38 is a rear view thereof;
FIG. 39 is a left side view thereof;
FIG. 40 is a right side view thereof;
FIG. 41 is a top view thereof;
FIG. 42 is a bottom view thereof;
FIG. 43 is a perspective view of packaging showing our new design;
FIG. 44 is a front view thereof;

FIG. 45 is a rear view thereof;
FIG. 46 is a left side view thereof;
FIG. 47 is a right side view thereof;
FIG. 48 is a top view thereof;
FIG. 49 is a bottom view thereof;
FIG. 50 is a perspective view of packaging showing our new design;
FIG. 51 is a front view thereof;
FIG. 52 is a rear view thereof;
FIG. 53 is a left side view thereof;
FIG. 54 is a right side view thereof;
FIG. 55 is a top view thereof;
FIG. 56 is a bottom view thereof;
FIG. 57 is a perspective view of packaging showing our new design;
FIG. 58 is a front view thereof;
FIG. 59 is a rear view thereof;
FIG. 60 is a left side view thereof;
FIG. 61 is a right side view thereof;
FIG. 62 is a top view thereof;
FIG. 63 is a bottom view thereof;
FIG. 64 is a perspective view of packaging showing our new design;
FIG. 65 is a front view thereof;
FIG. 66 is a rear view thereof;
FIG. 67 is a left side view thereof;
FIG. 68 is a right side view thereof;
FIG. 69 is a top view thereof; and,
FIG. 70 is a bottom view thereof.

The broken lines of the packaging in the figures and the unshaded regions therein are for illustrative purposes only and form no part of the claimed design.

1 Claim, 50 Drawing Sheets

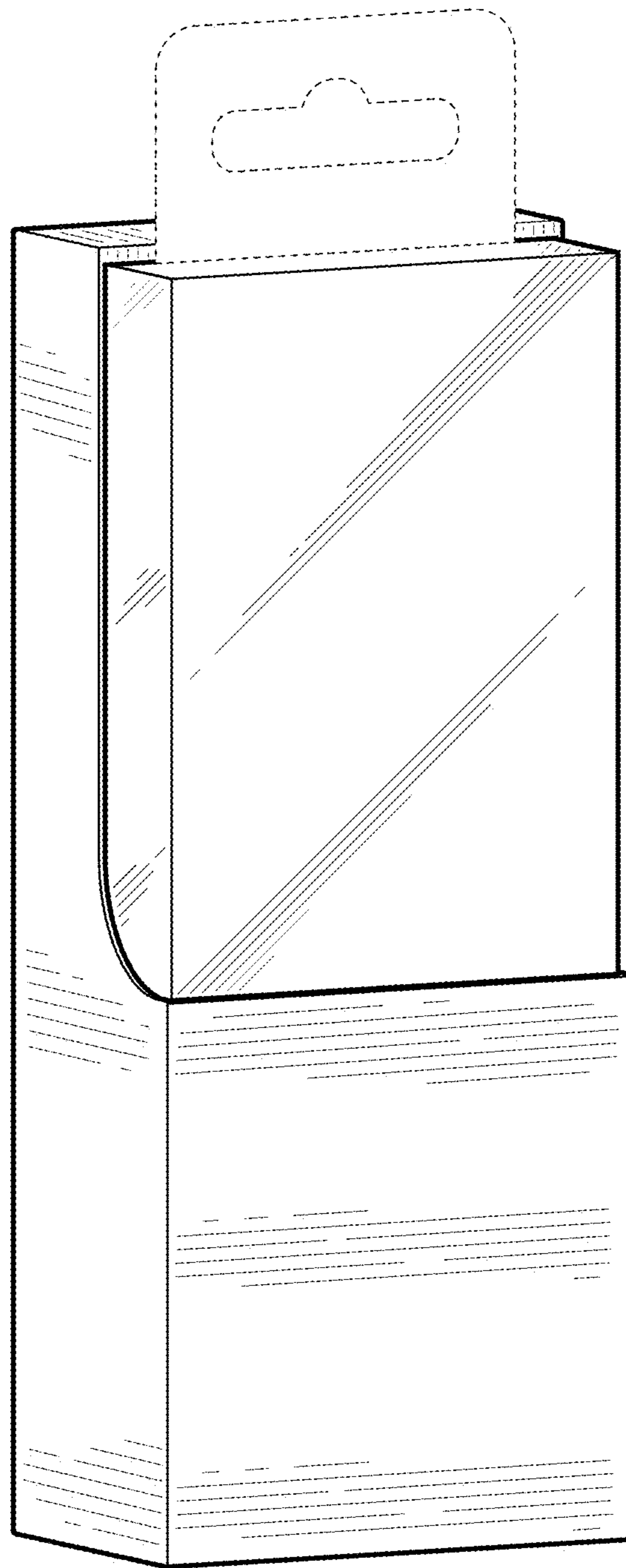

FIG. 1

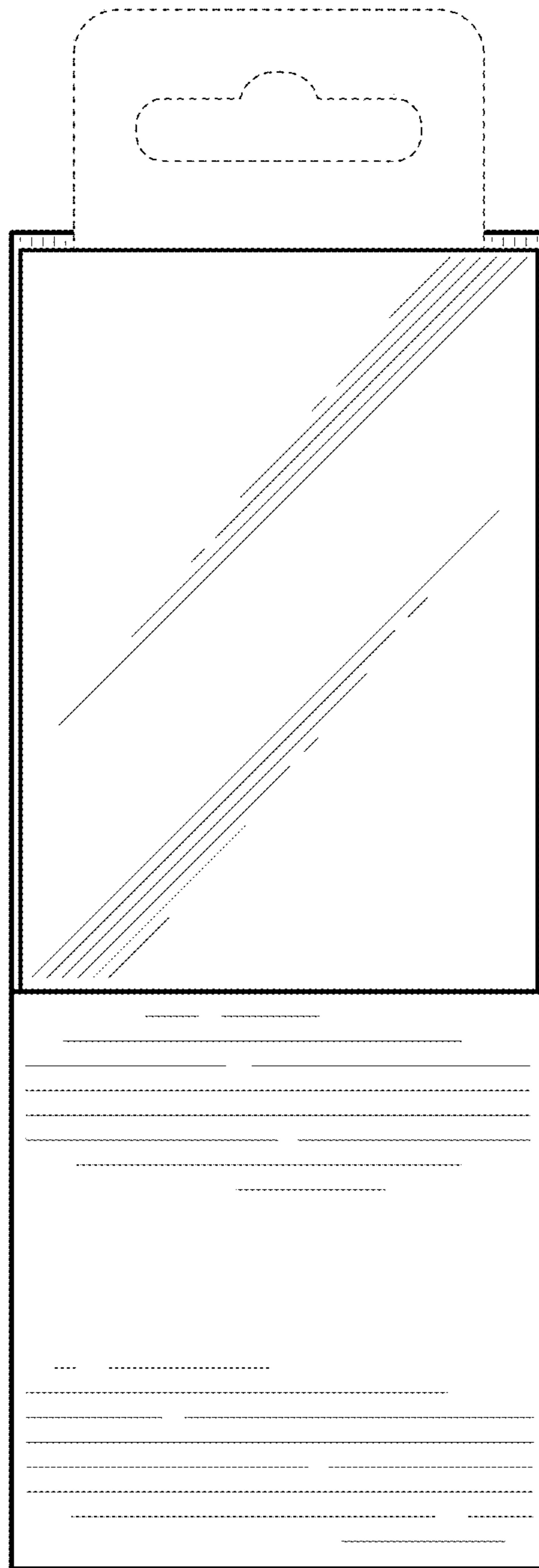

FIG. 2

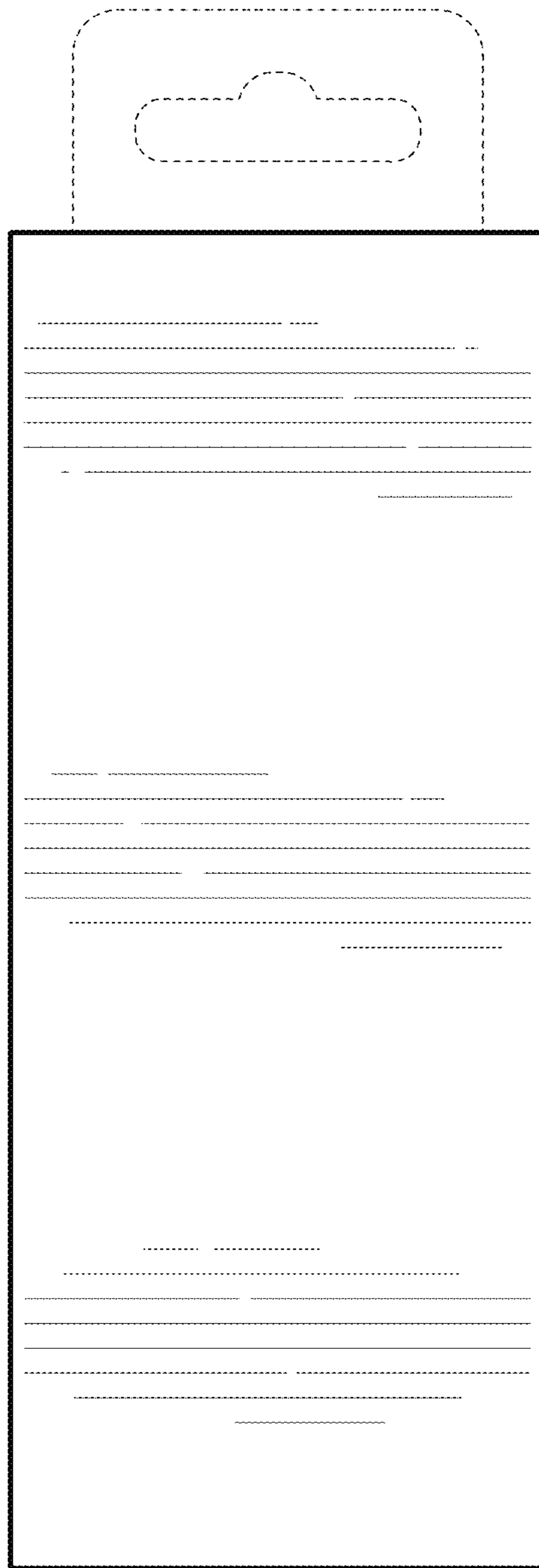

FIG. 3

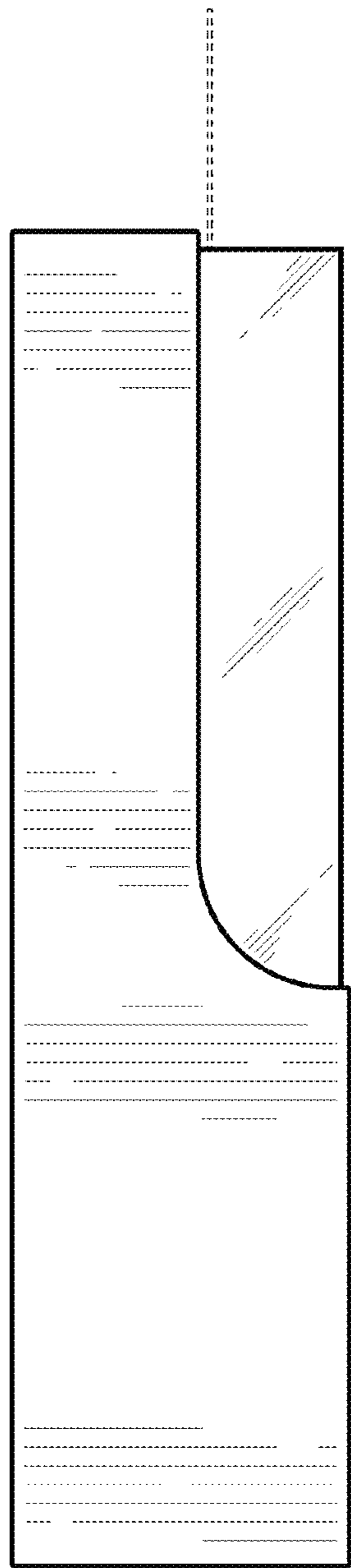

FIG. 4

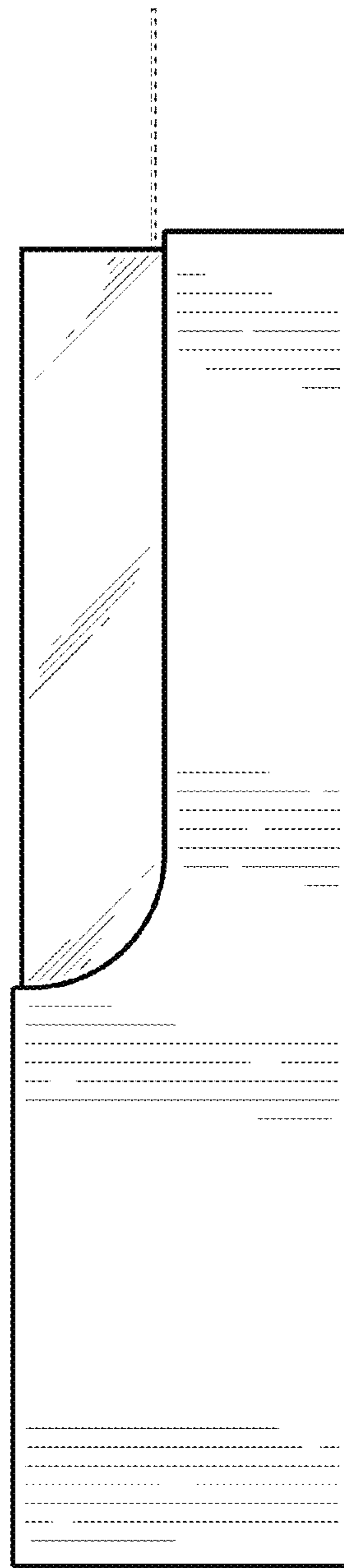

FIG. 5

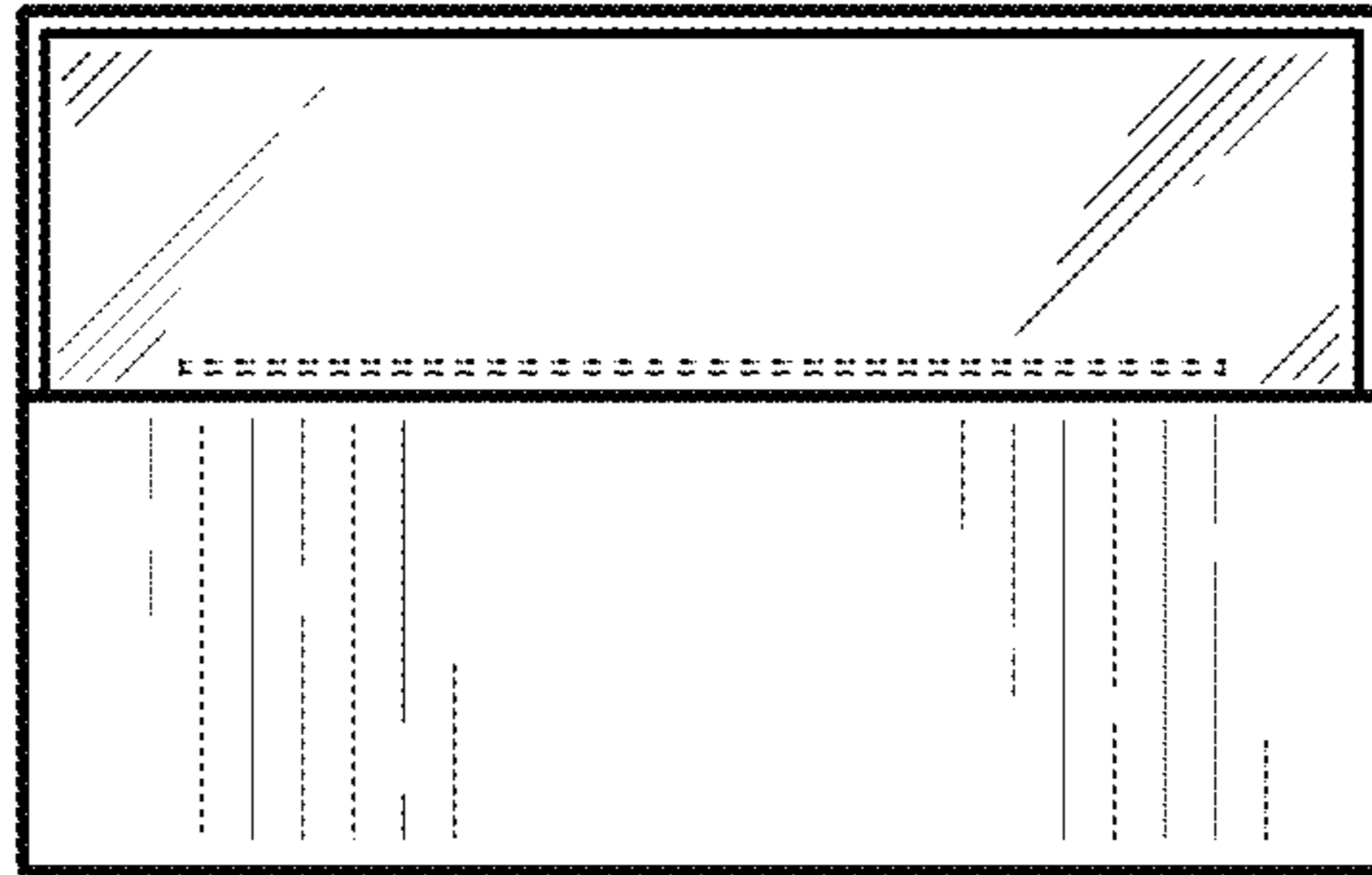

FIG. 6

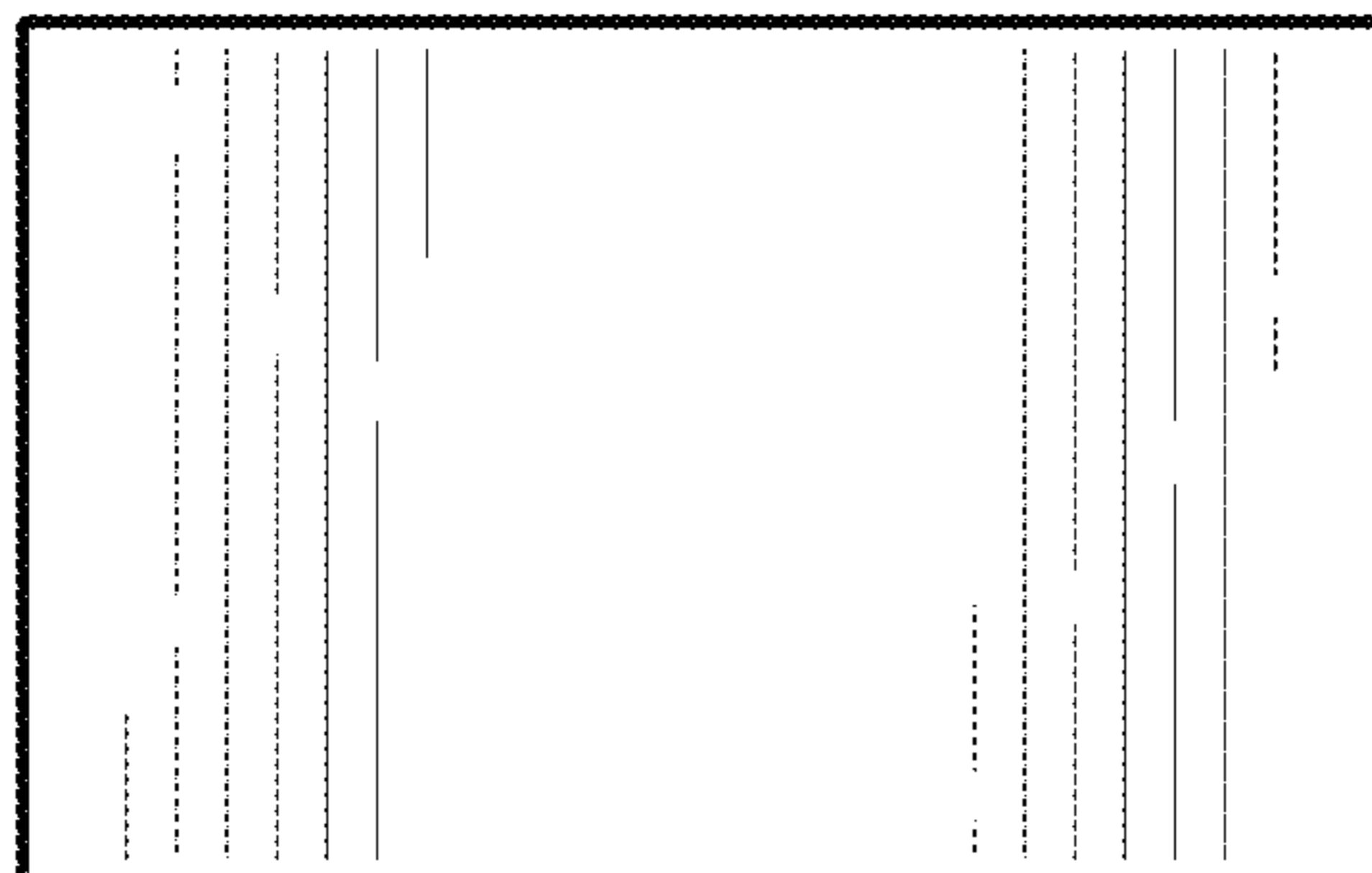

FIG. 7

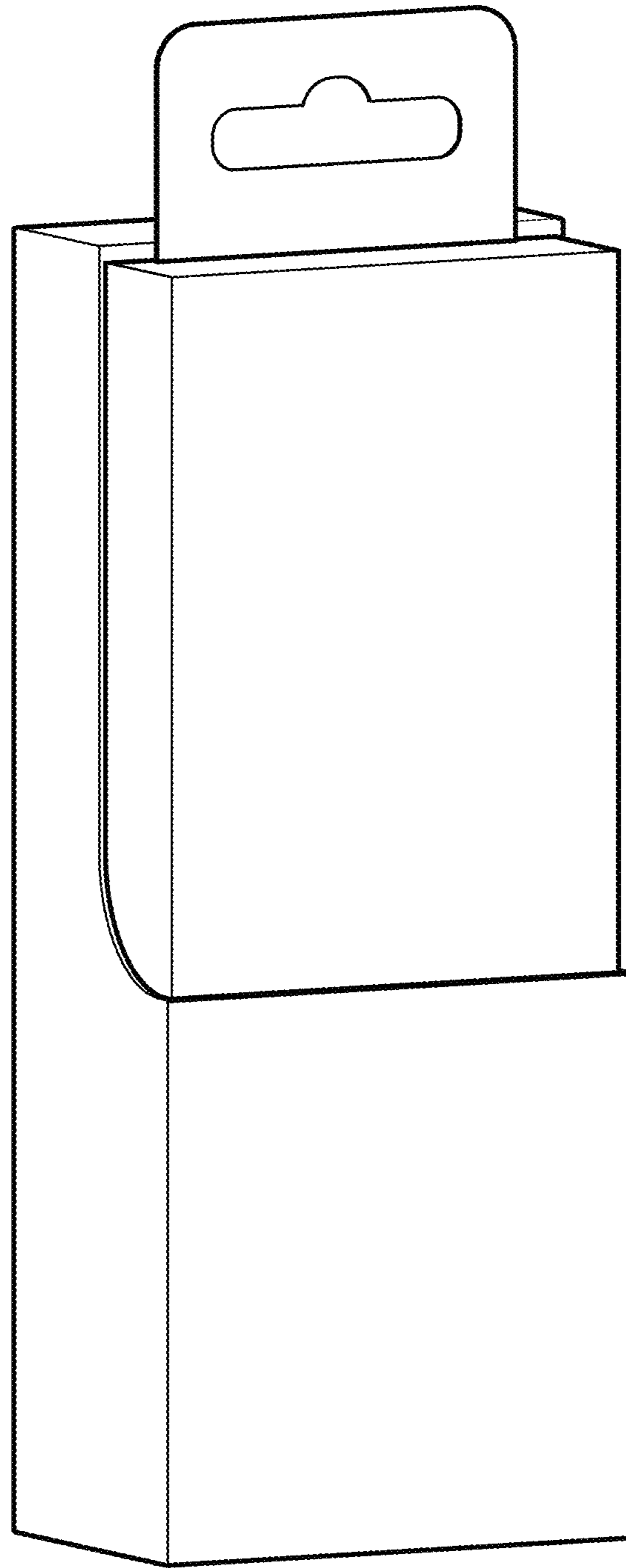

FIG. 8

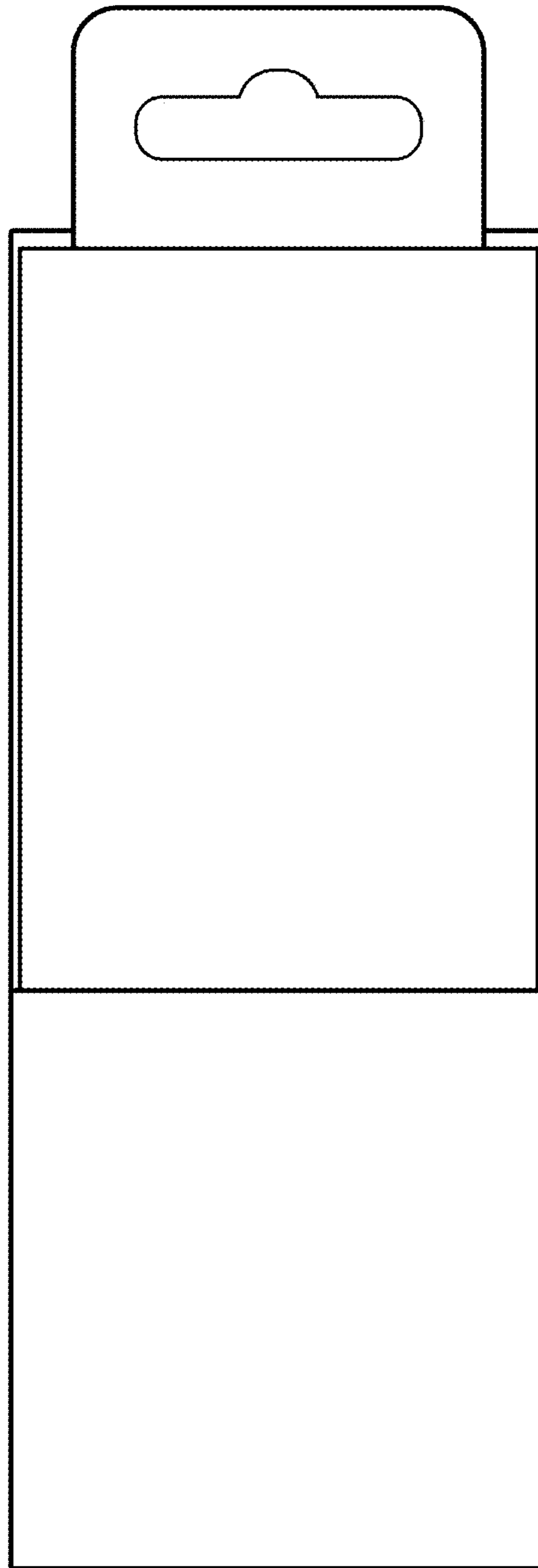

FIG. 9

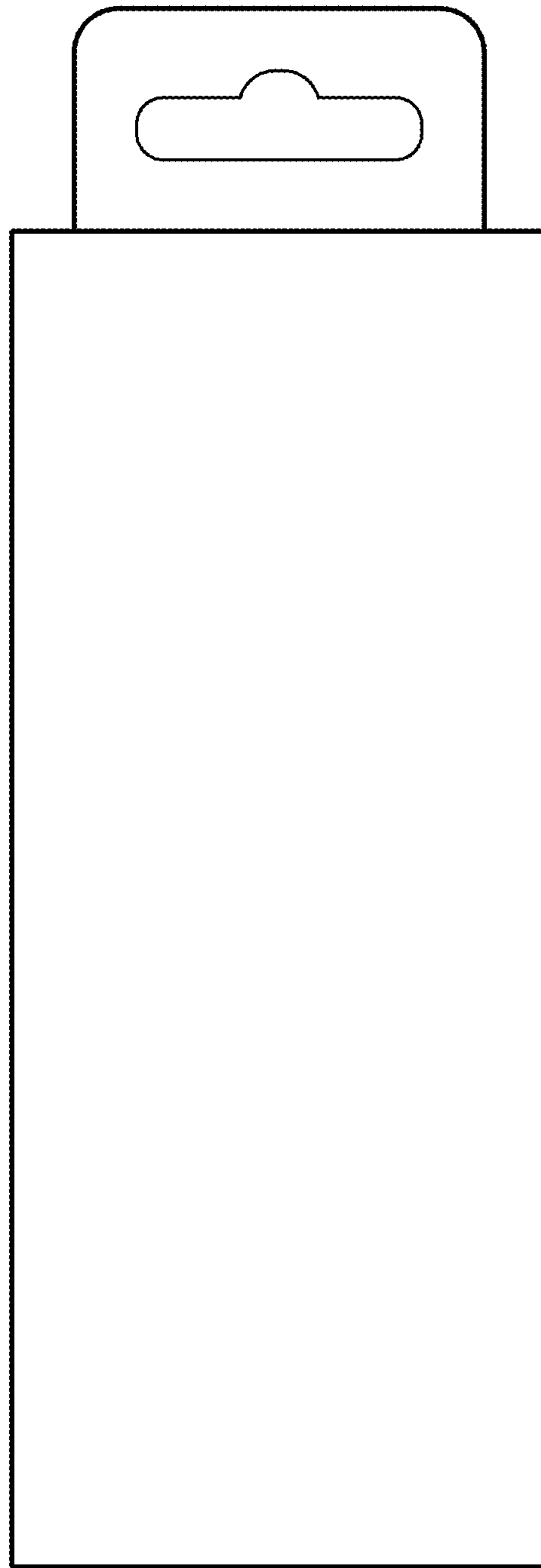

FIG. 10

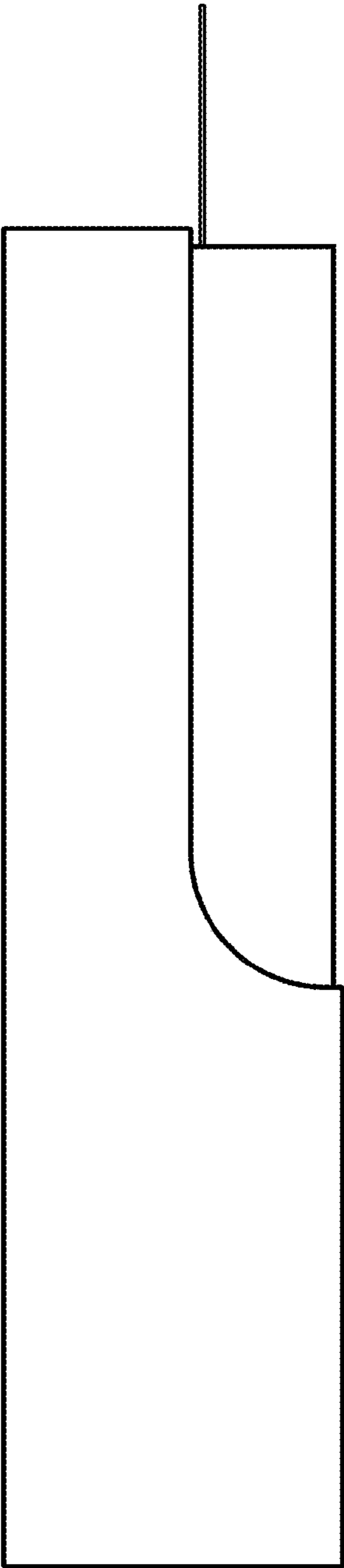

FIG. 11

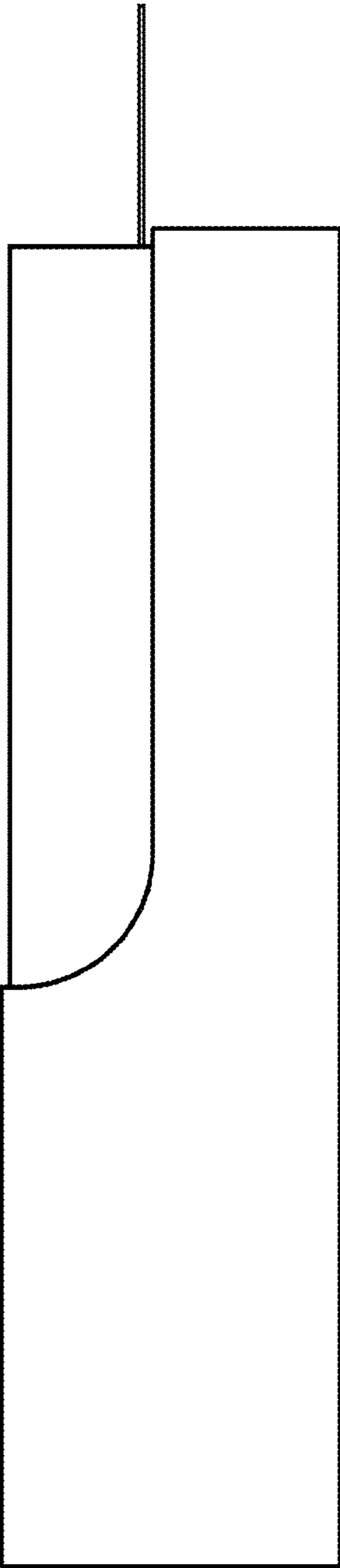

FIG. 12

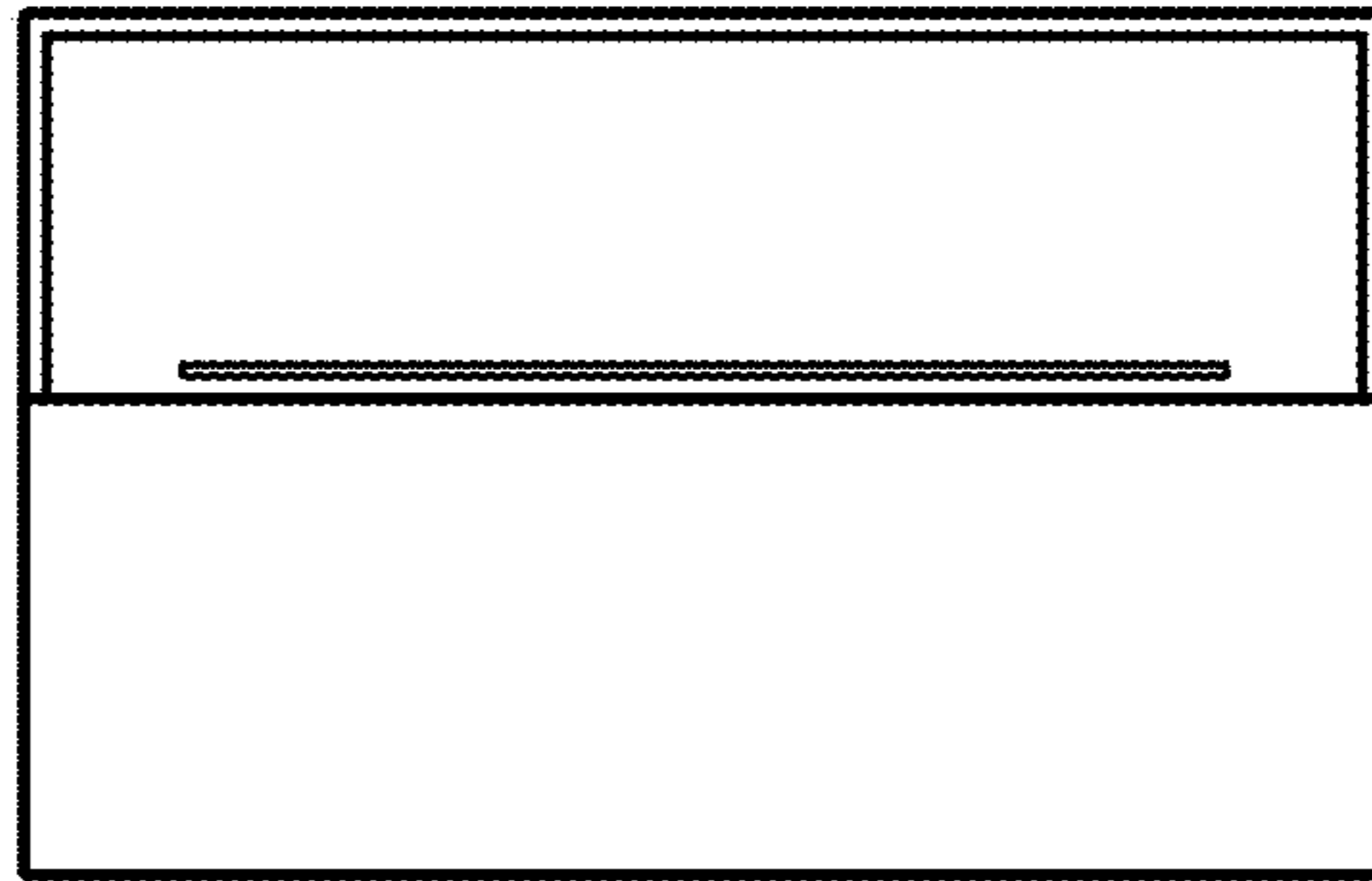

FIG. 13



FIG. 14

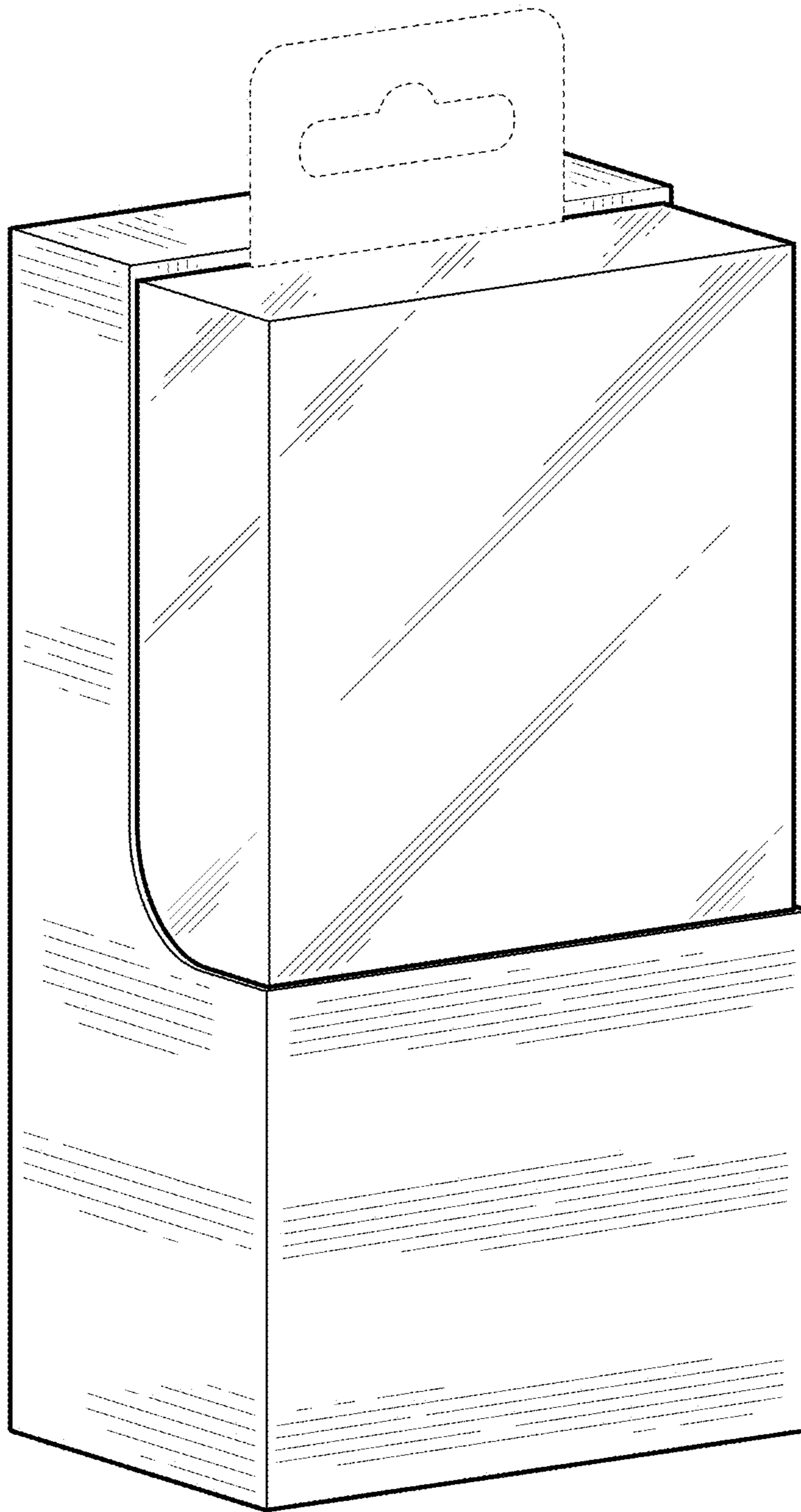

FIG. 15

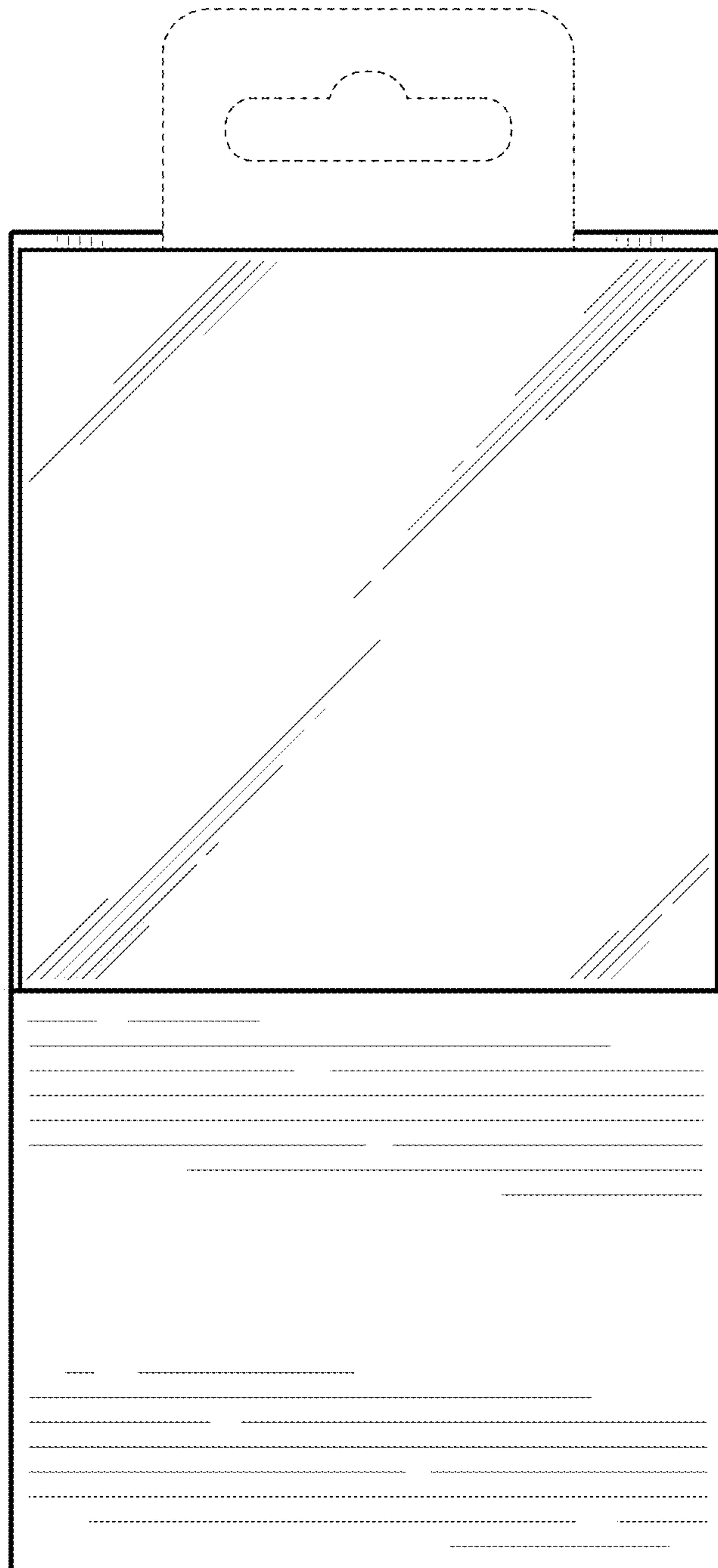

FIG. 16

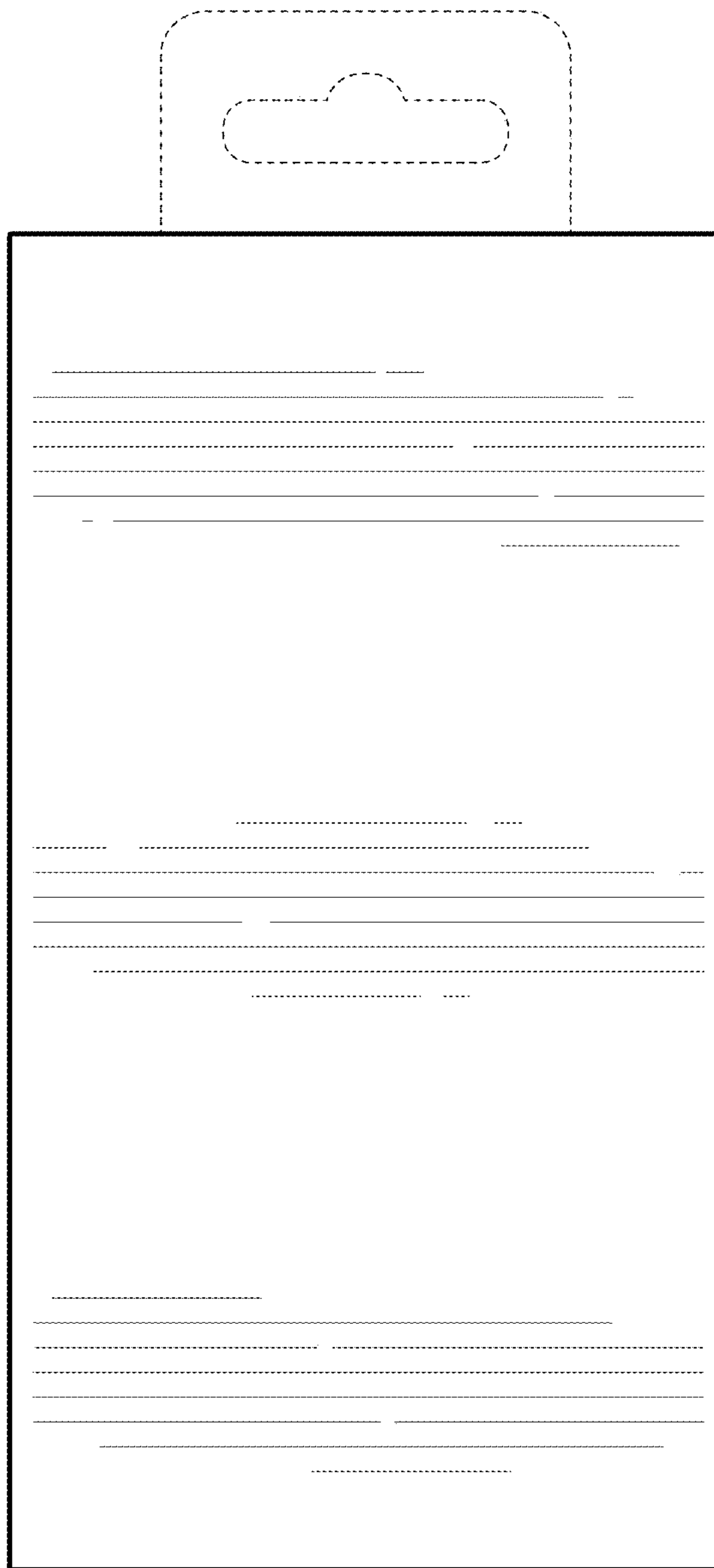

FIG. 17

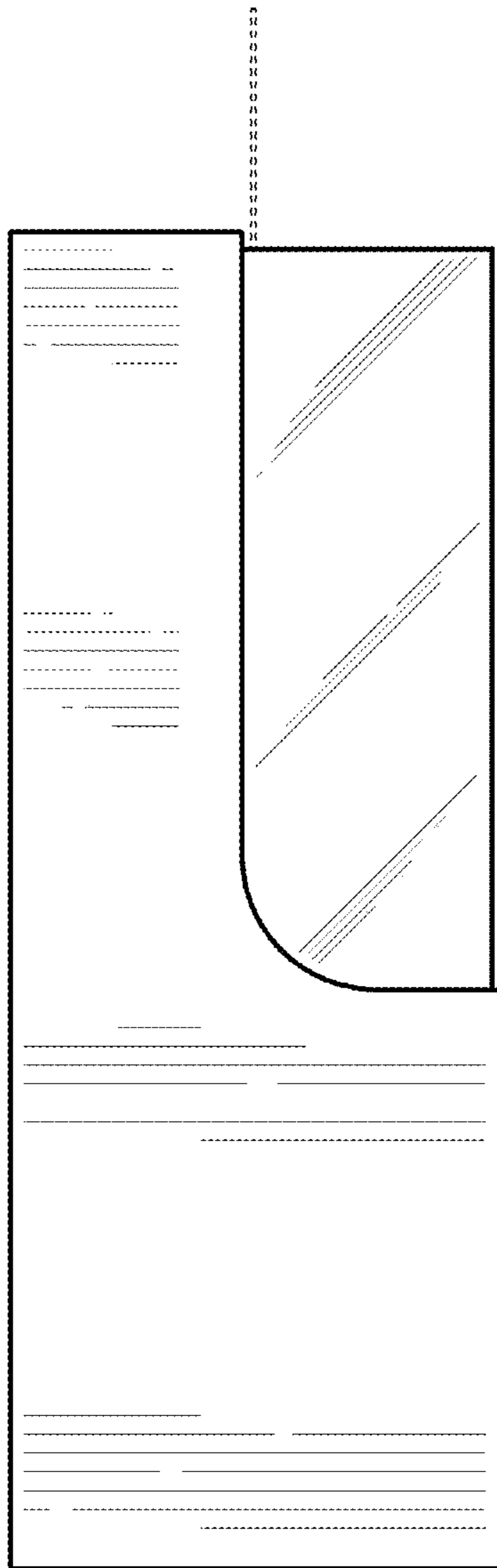

FIG. 18

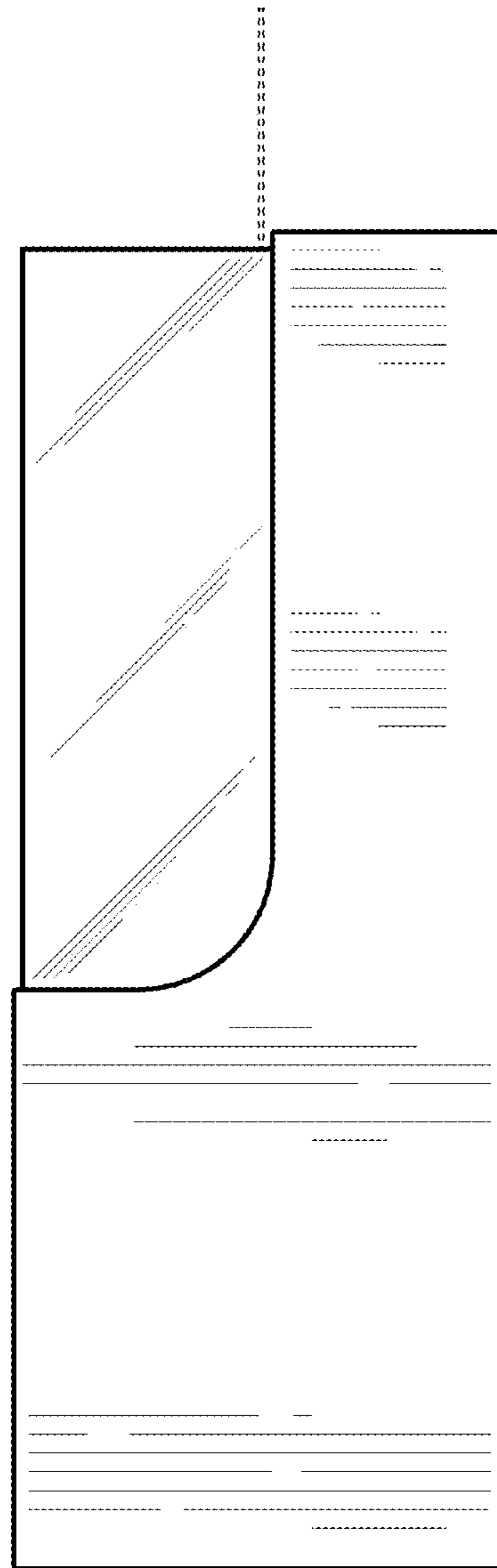

FIG. 19

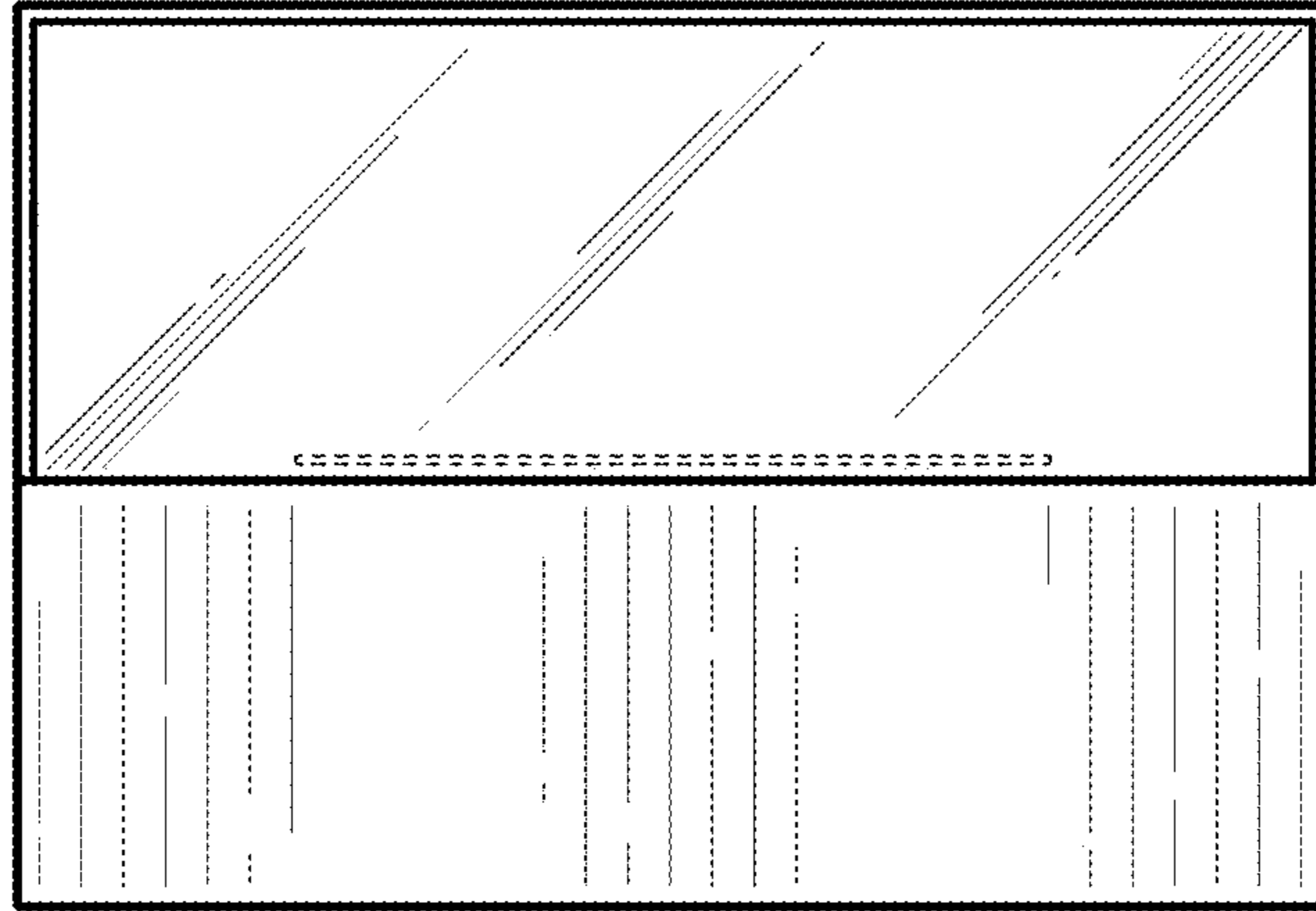

FIG. 20

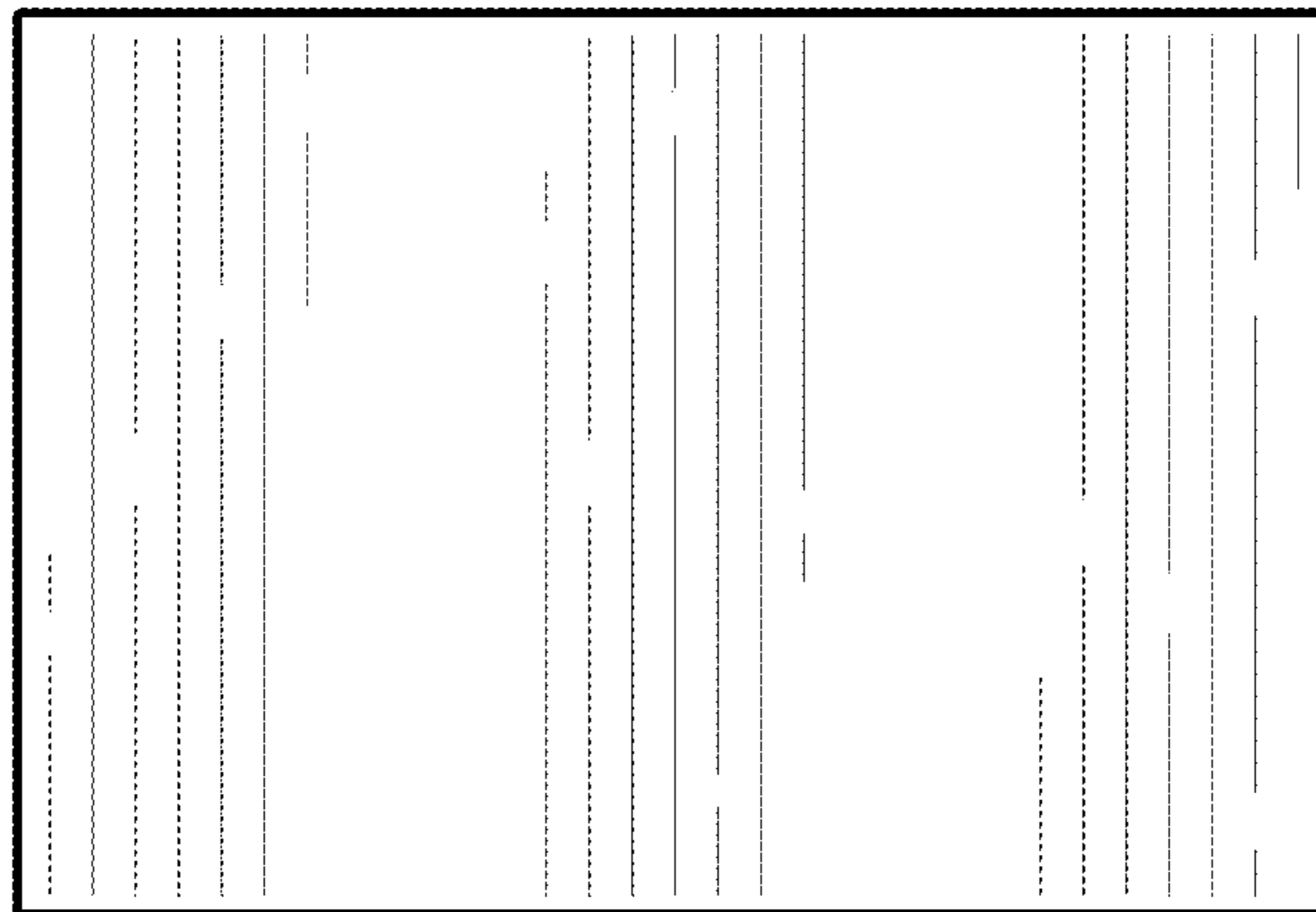

FIG. 21

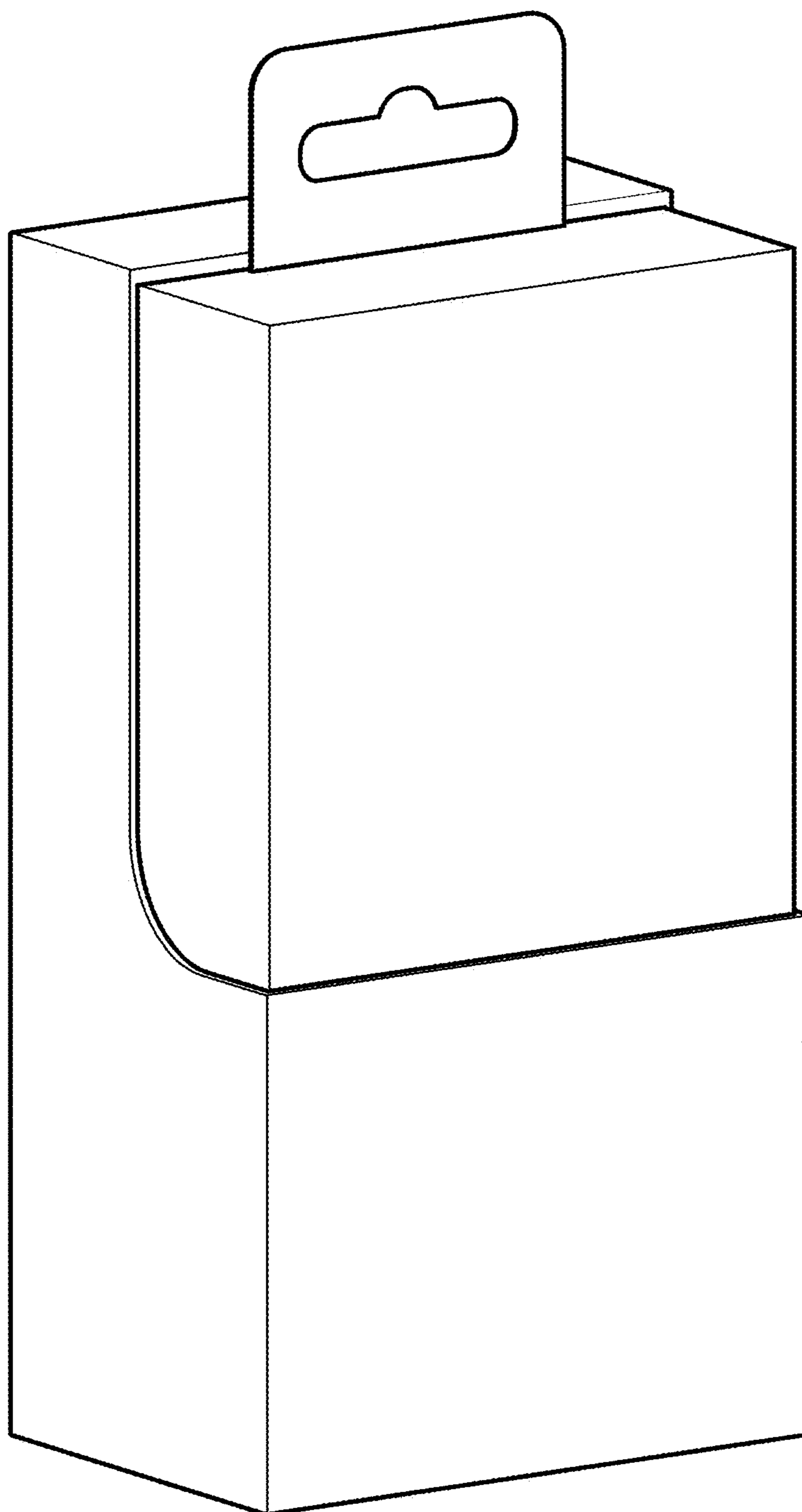

FIG. 22

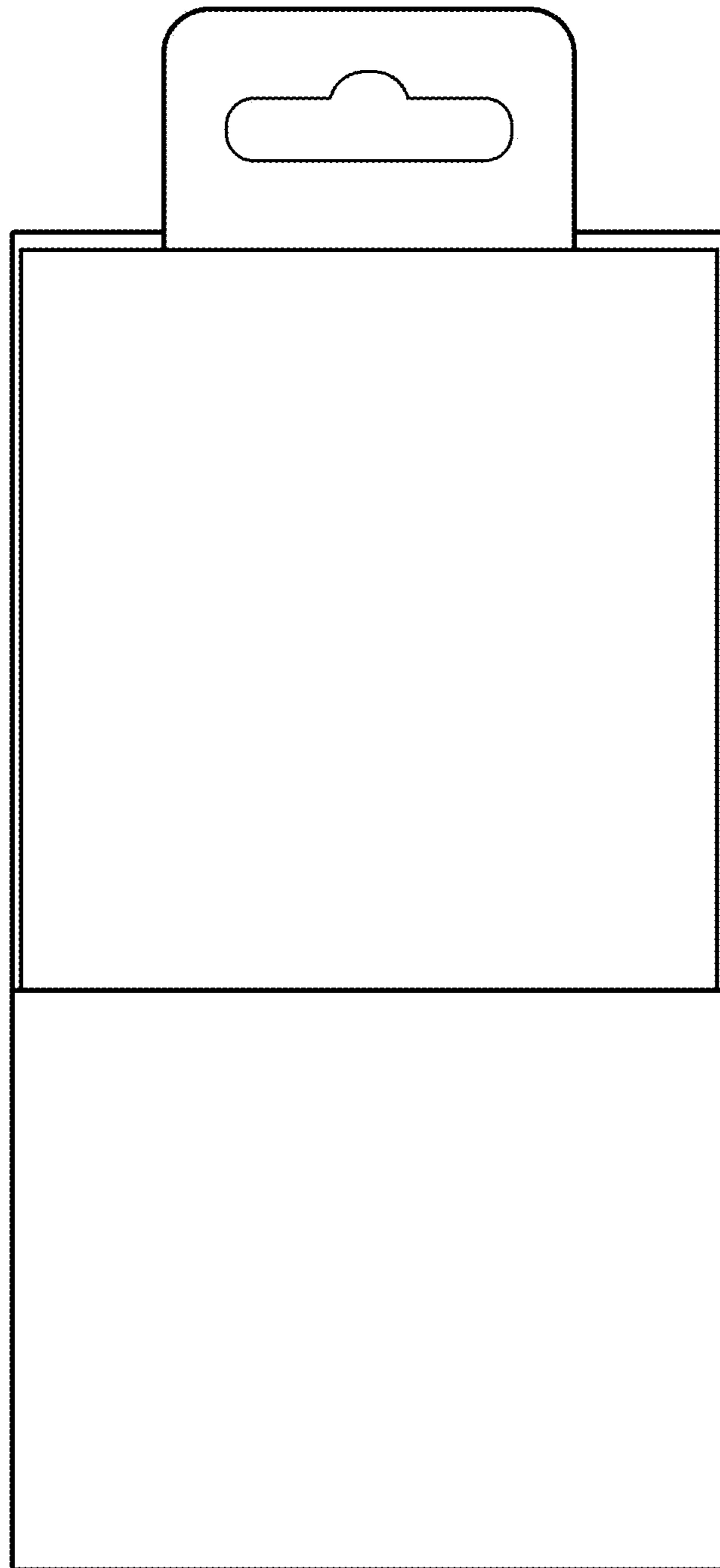

FIG. 23

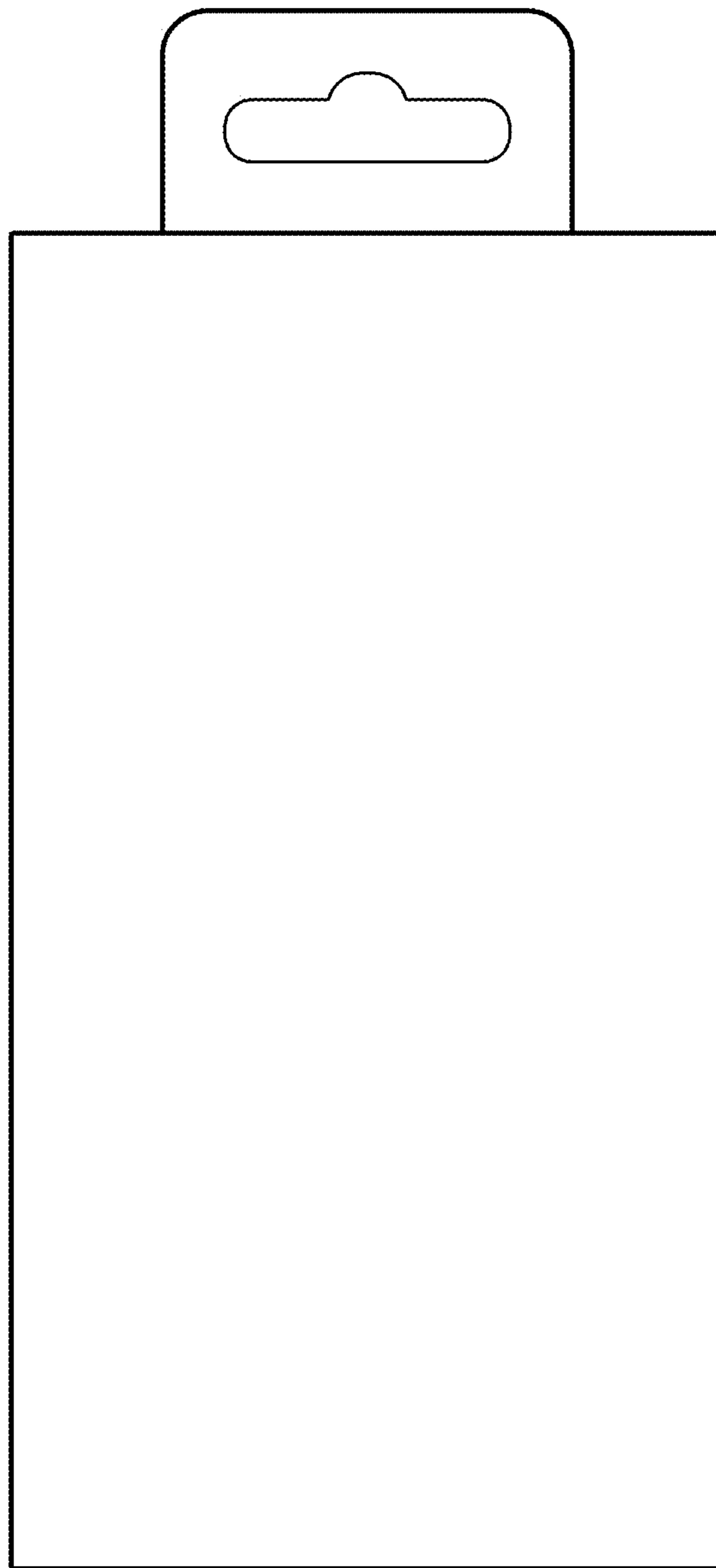

FIG. 24

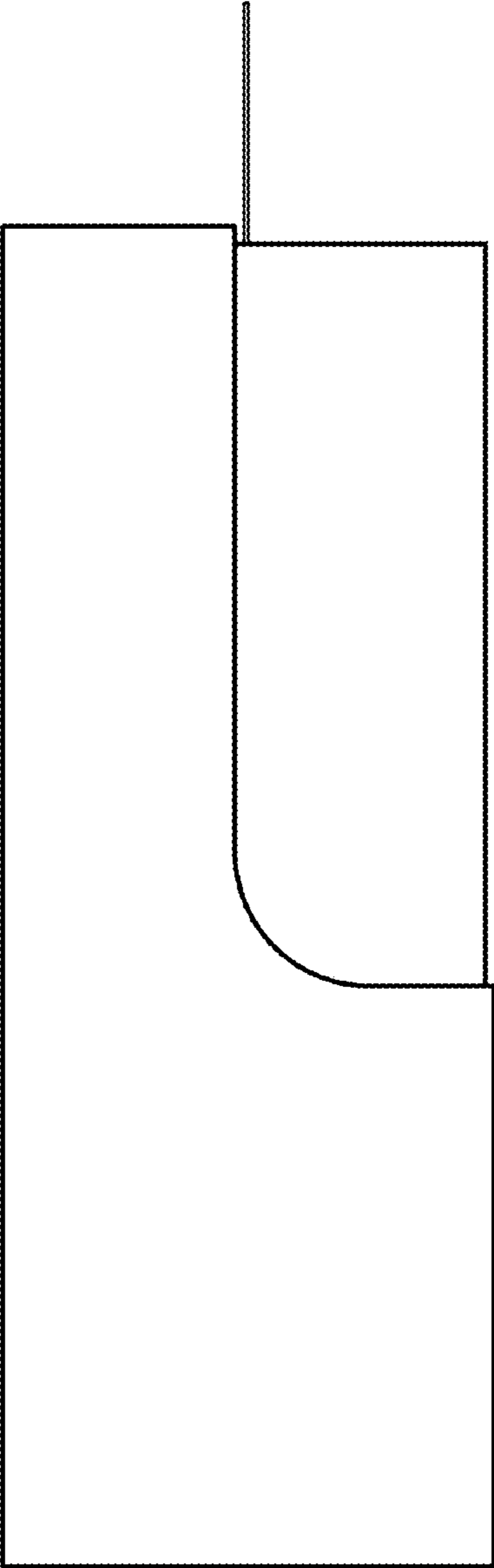

FIG. 25

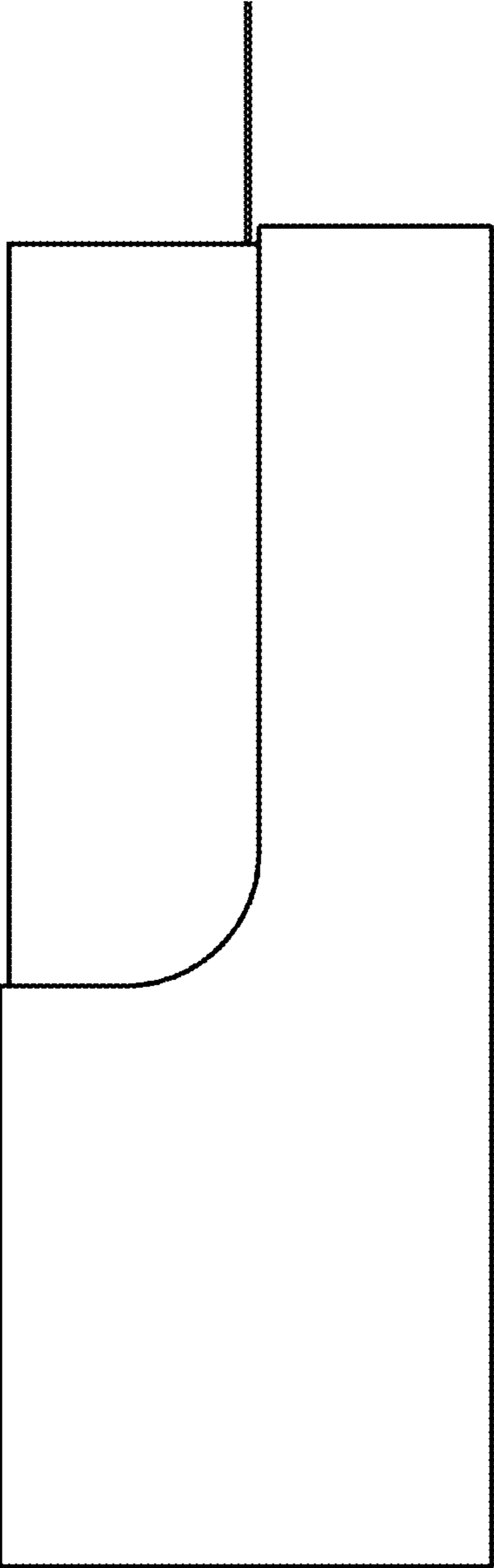

FIG. 26

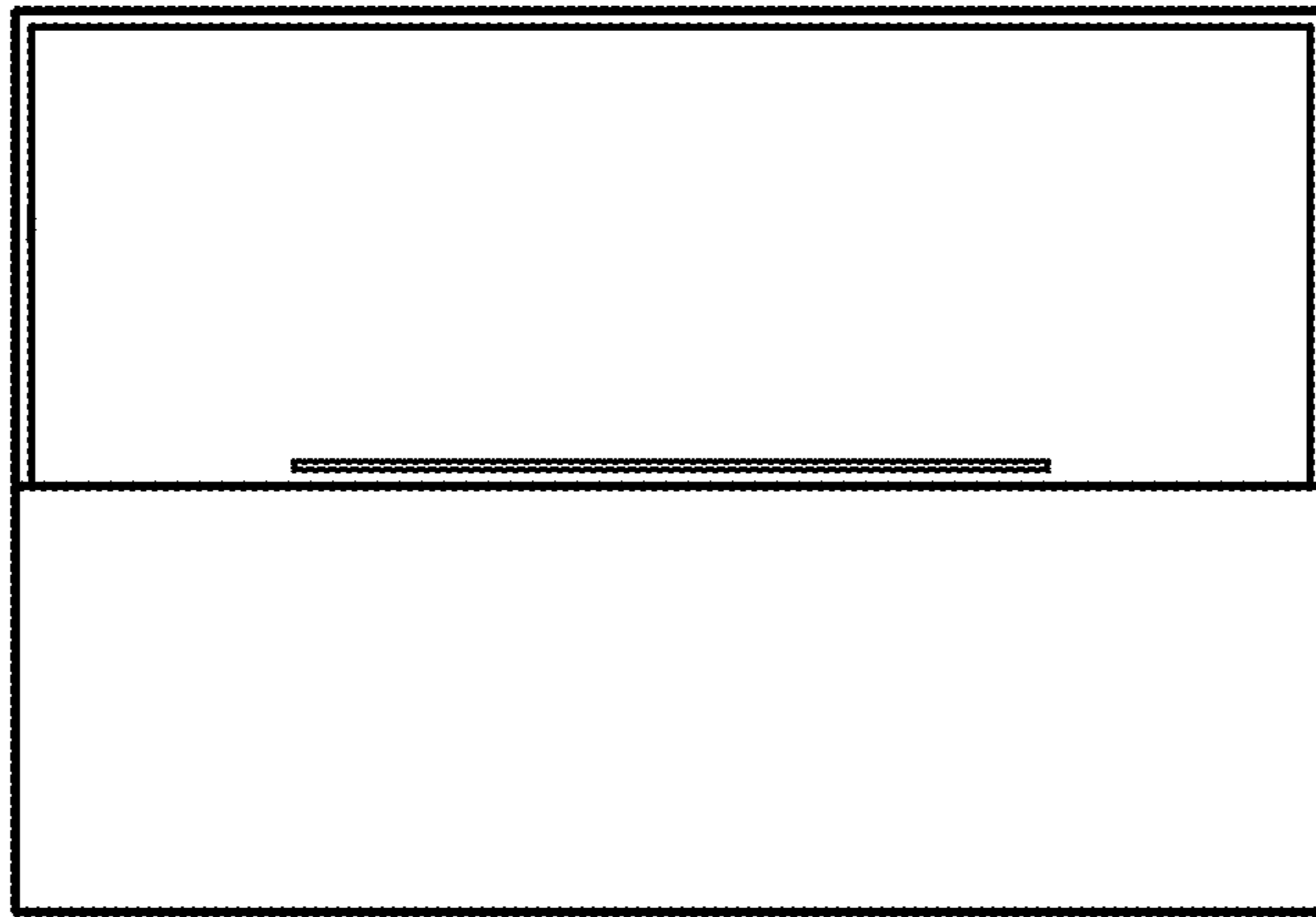

FIG. 27

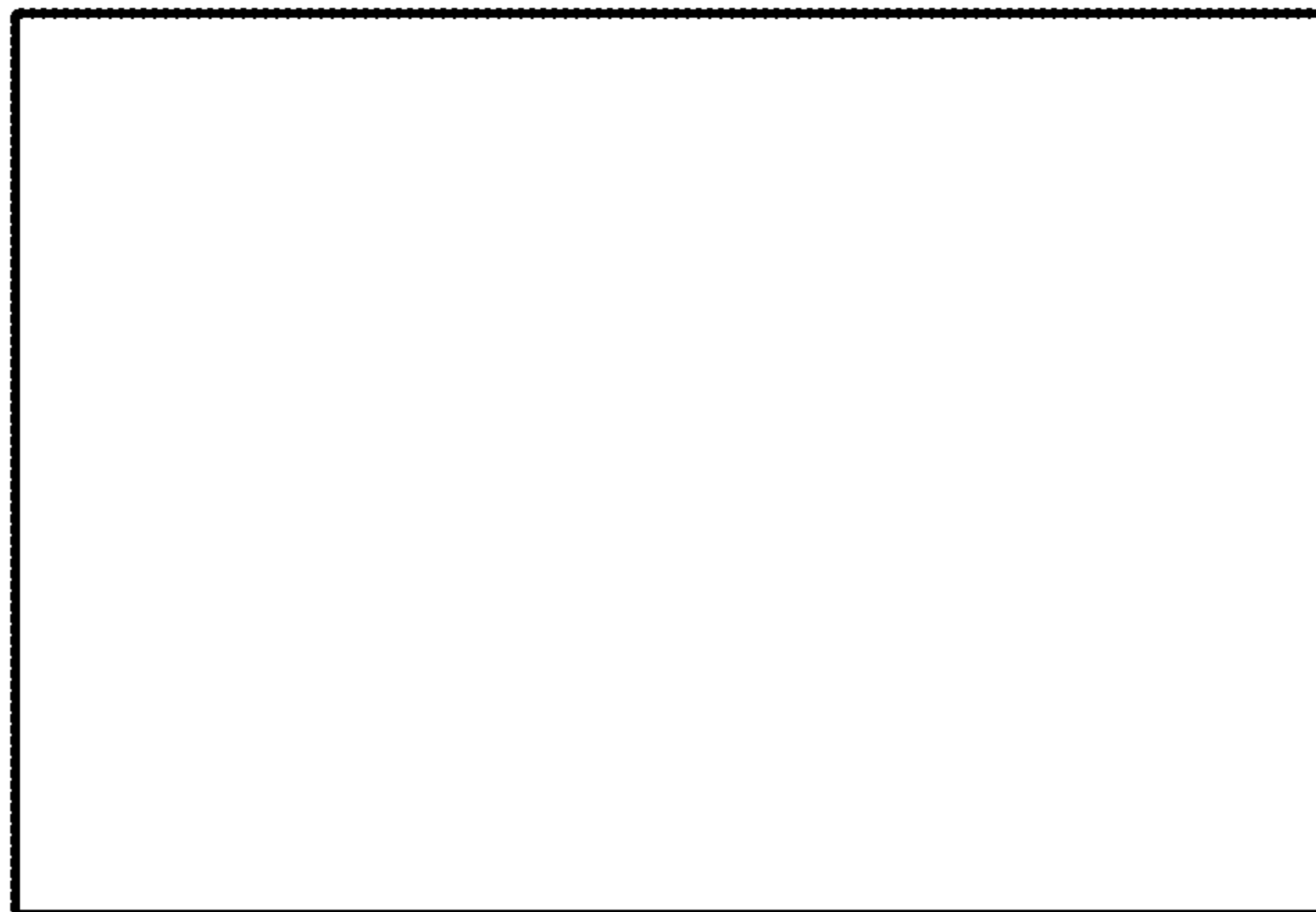

FIG. 28

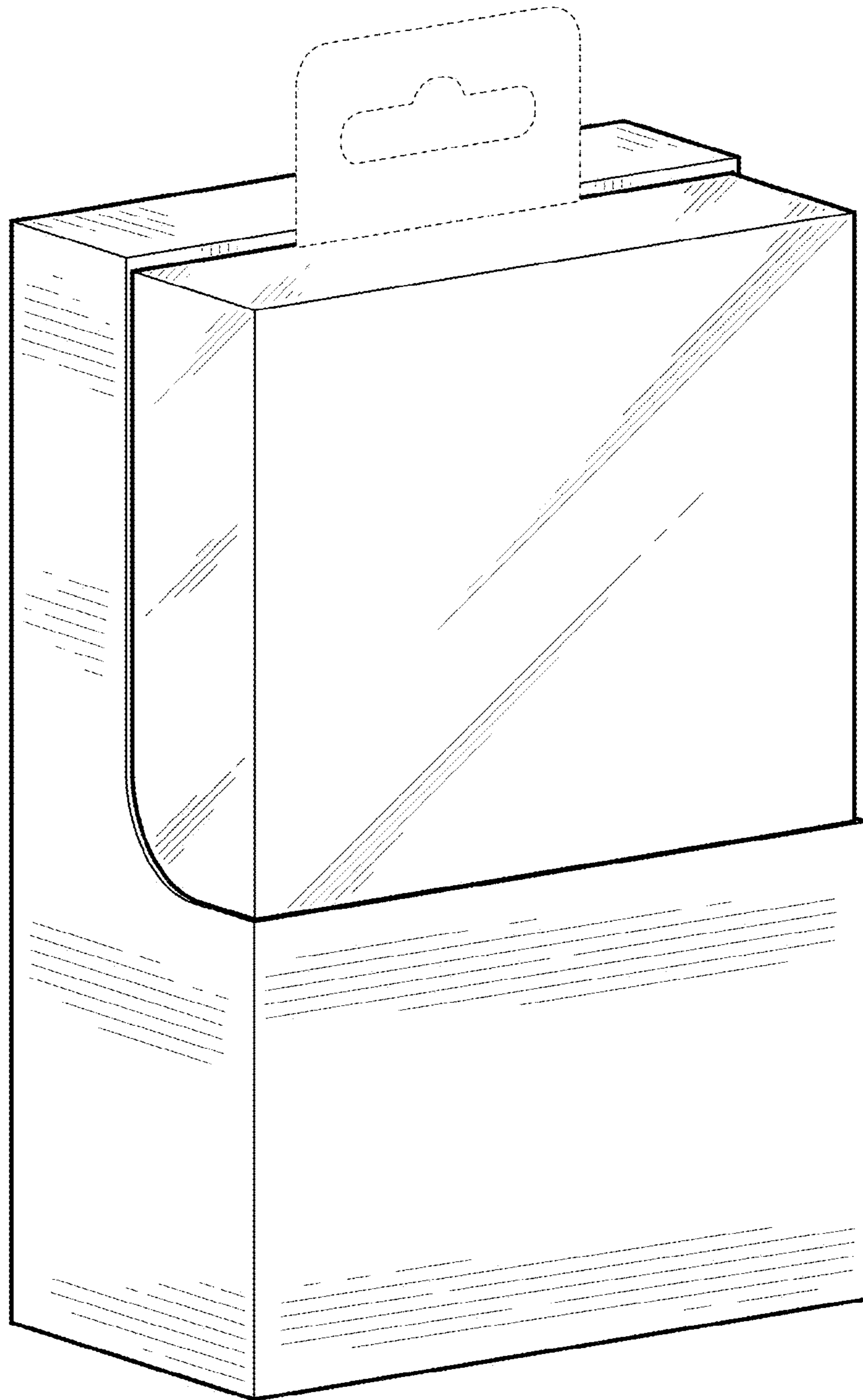

FIG. 29

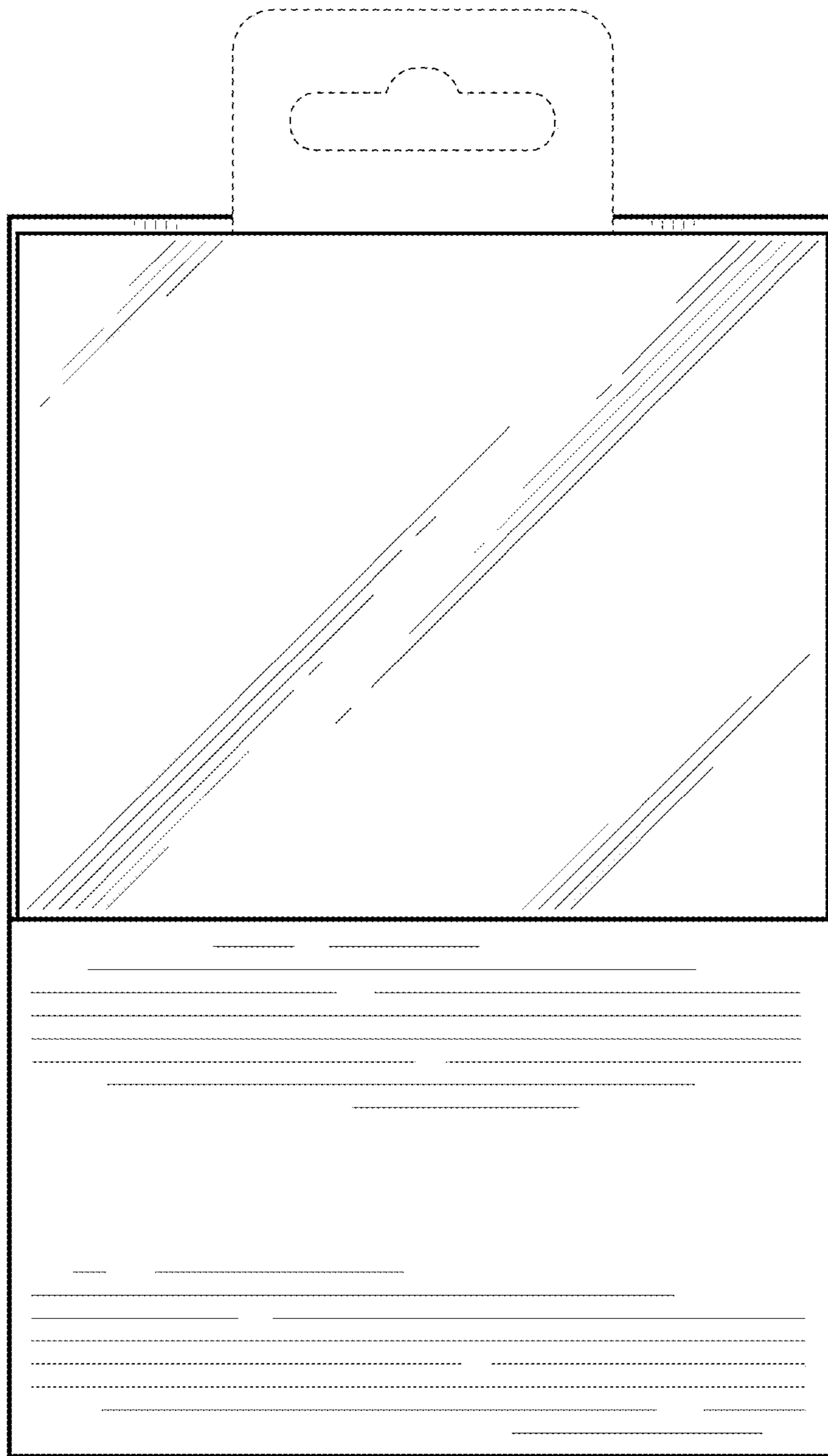

FIG. 30

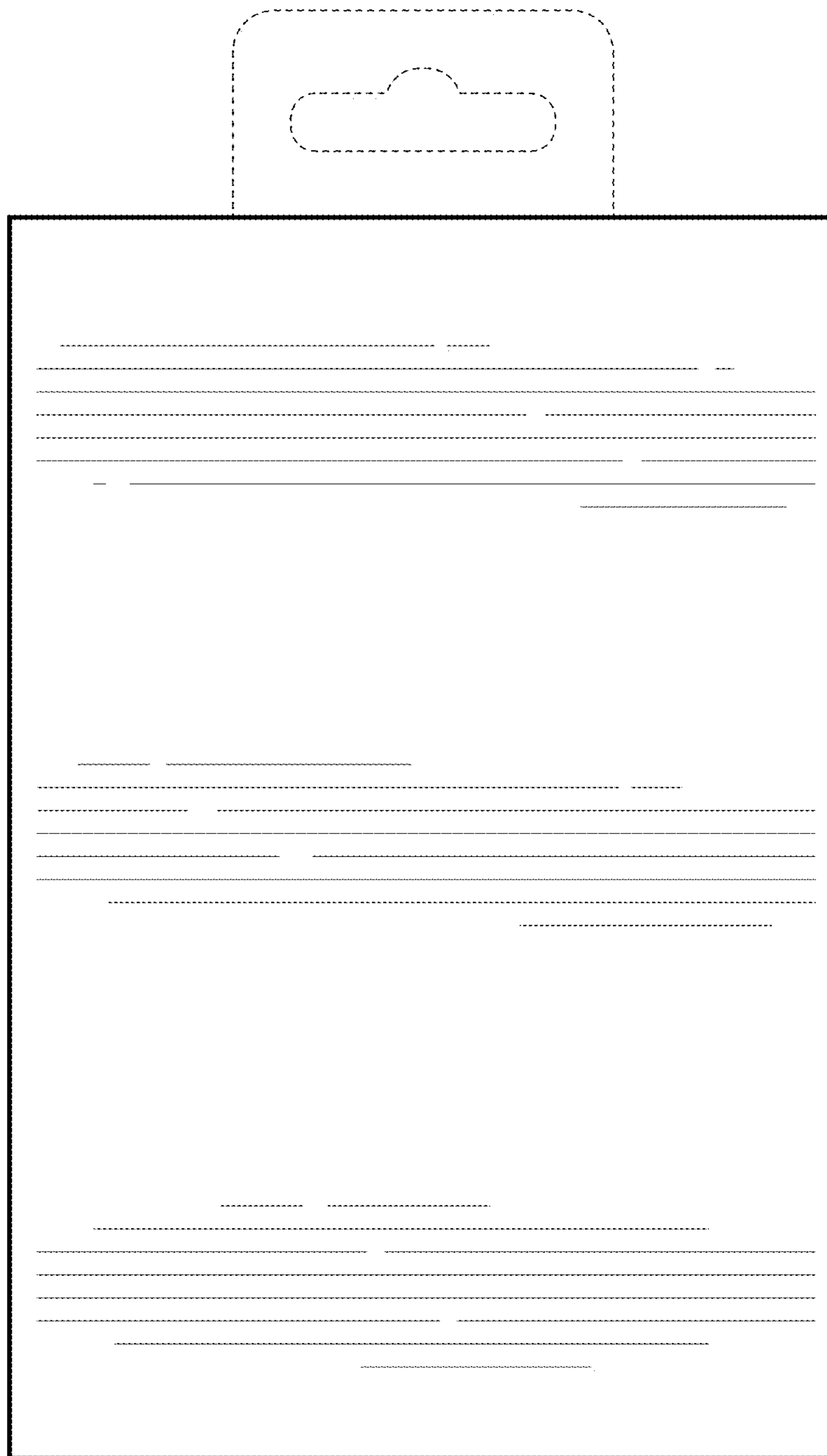

FIG. 31

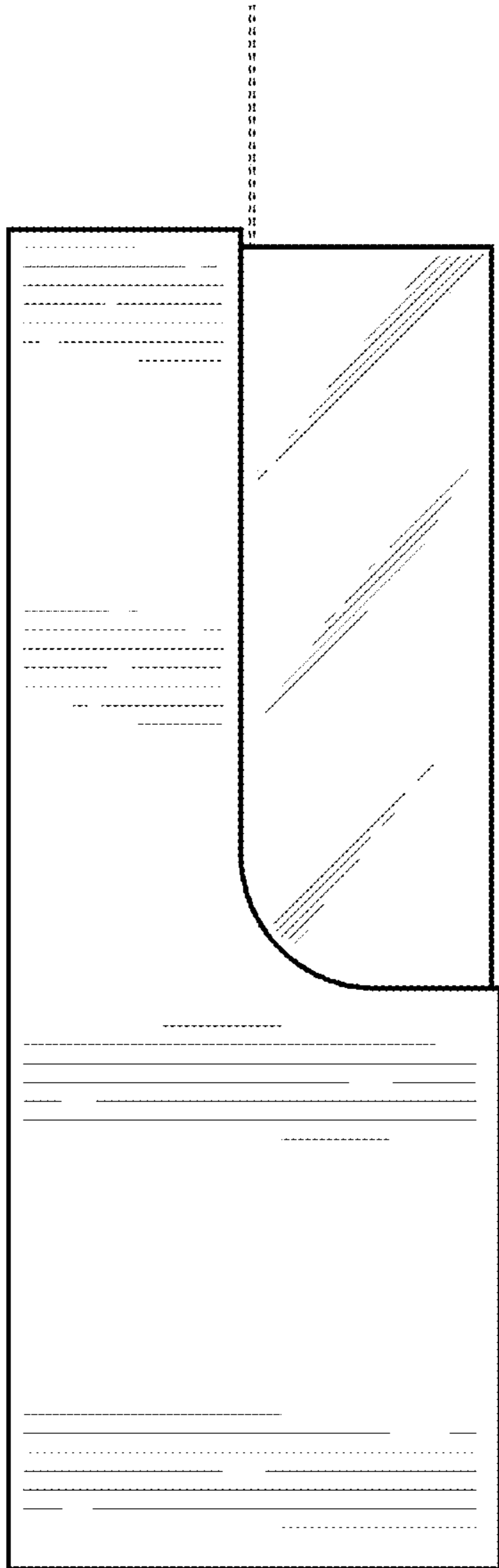

FIG. 32

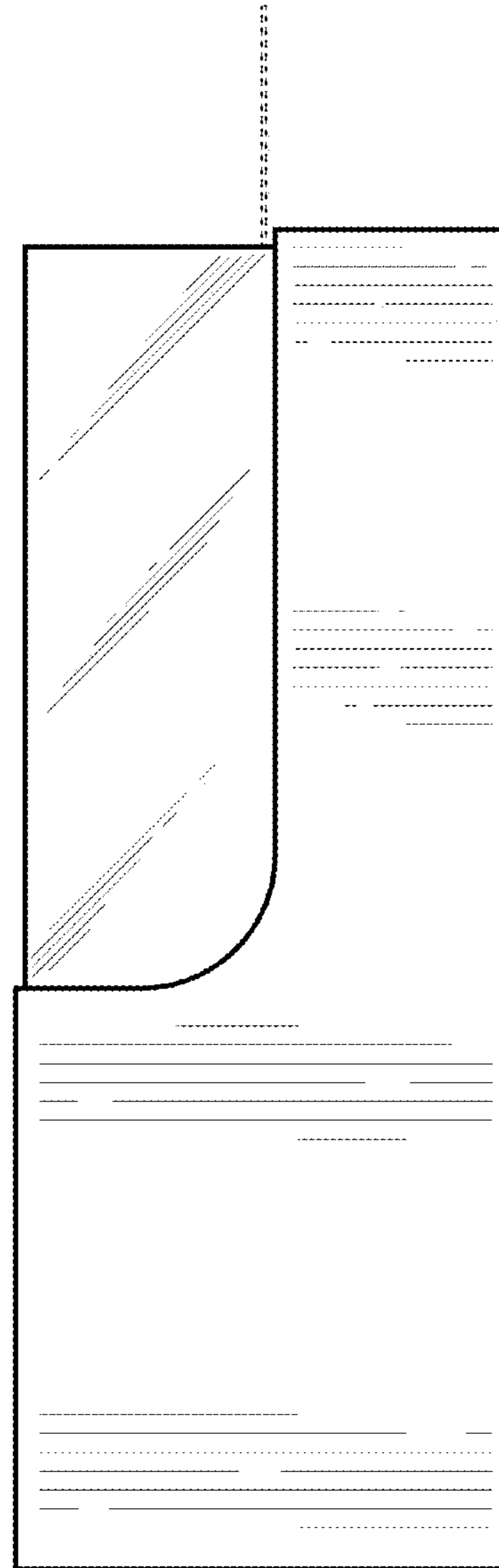

FIG. 33

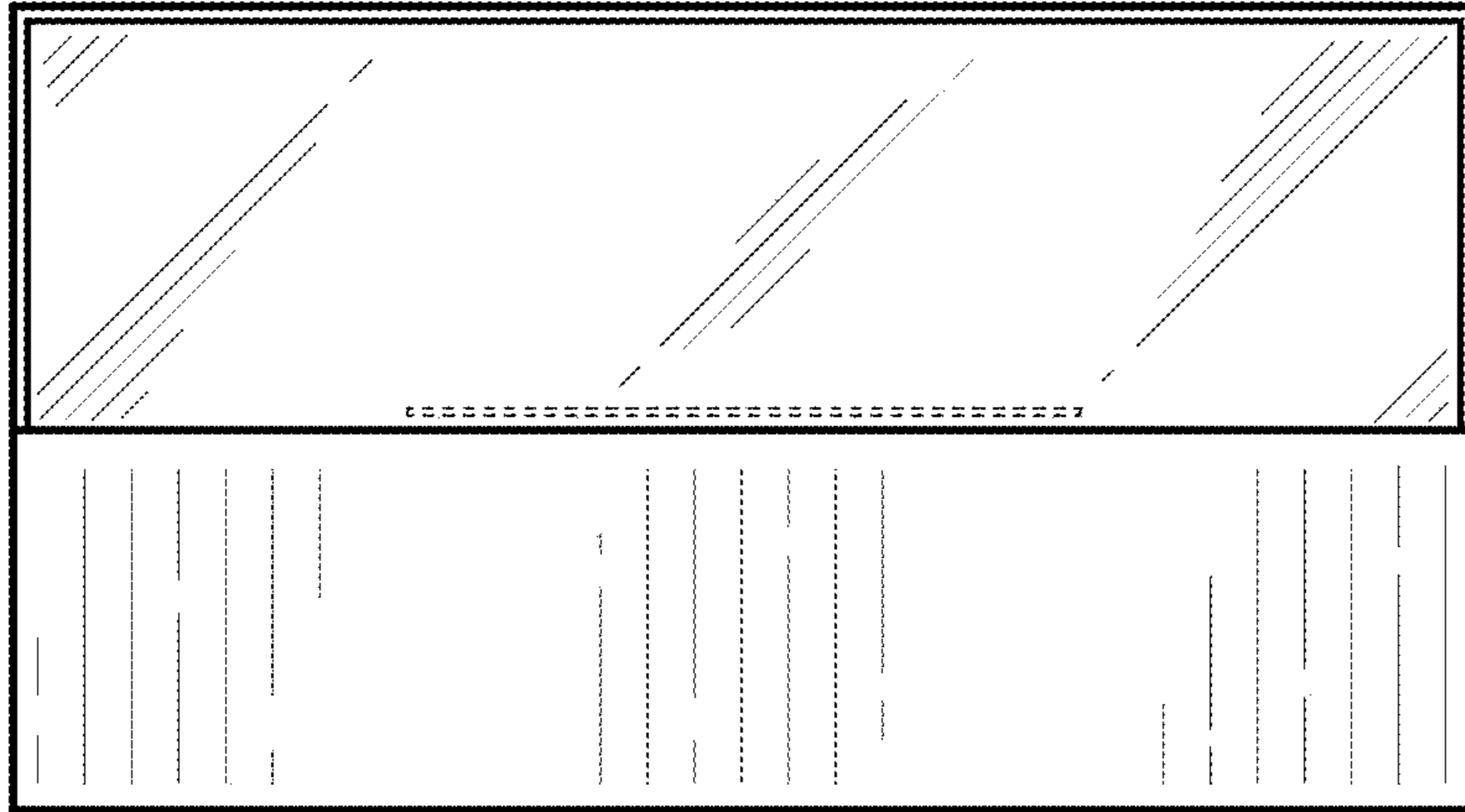

FIG. 34

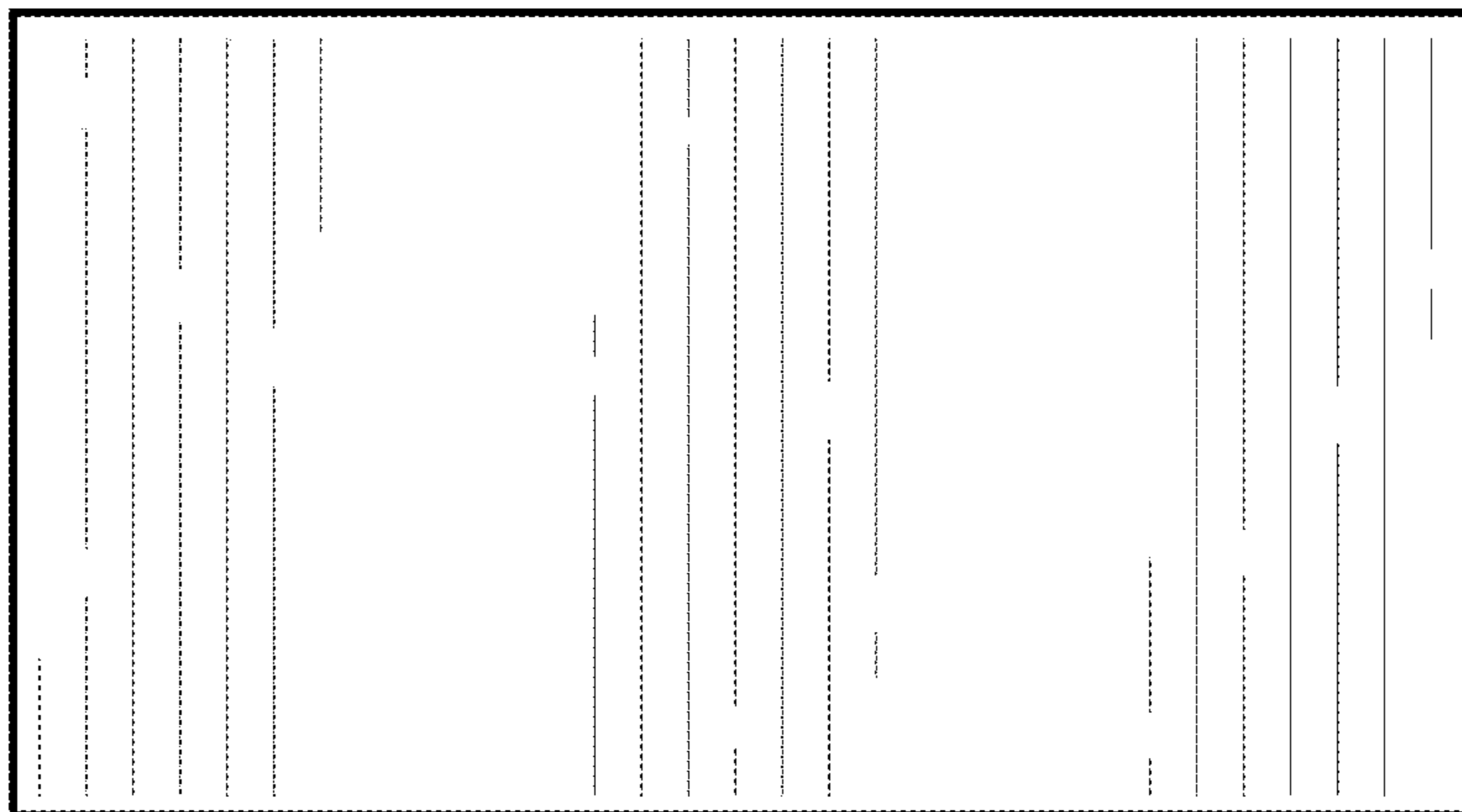

FIG. 35

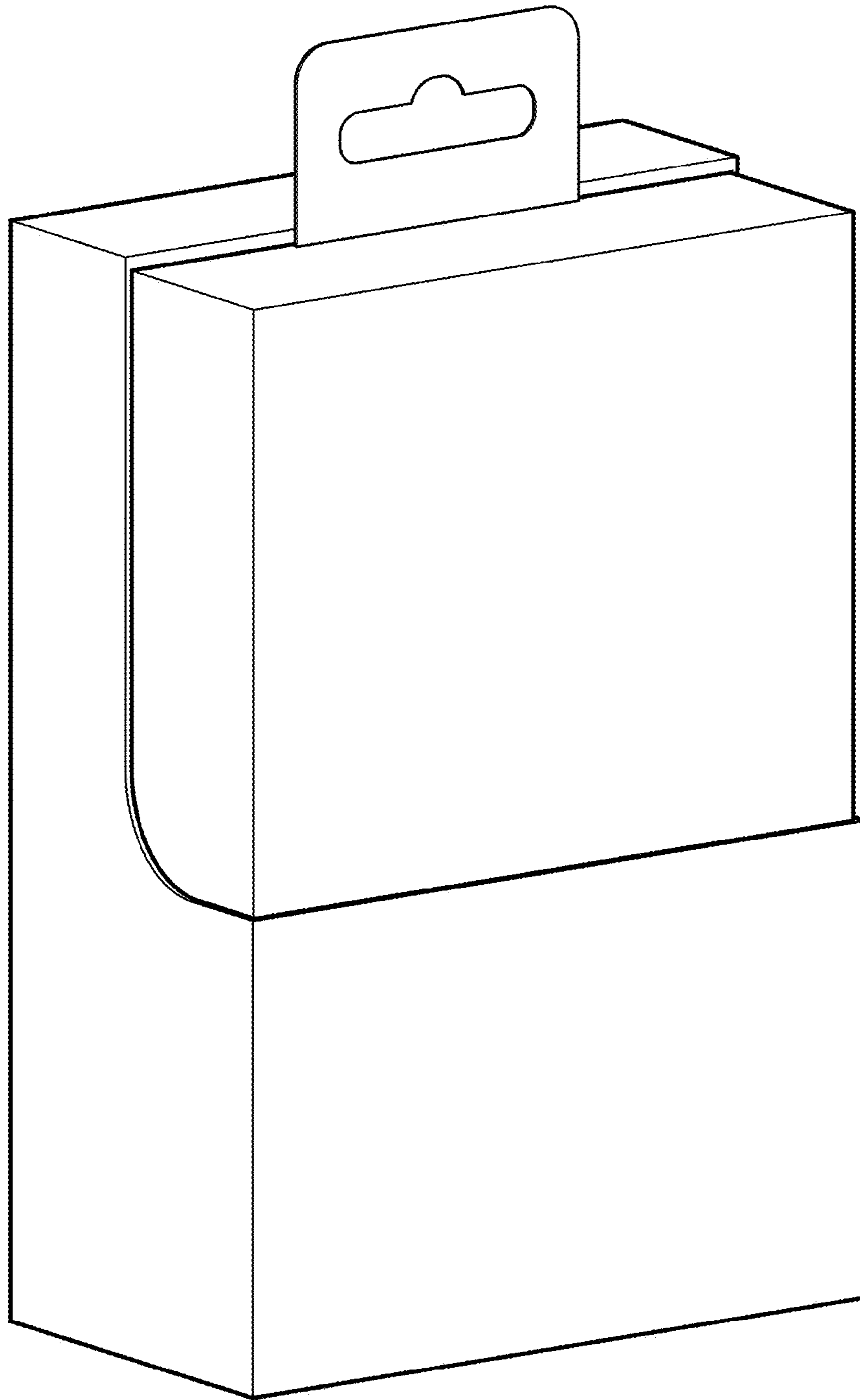

FIG. 36

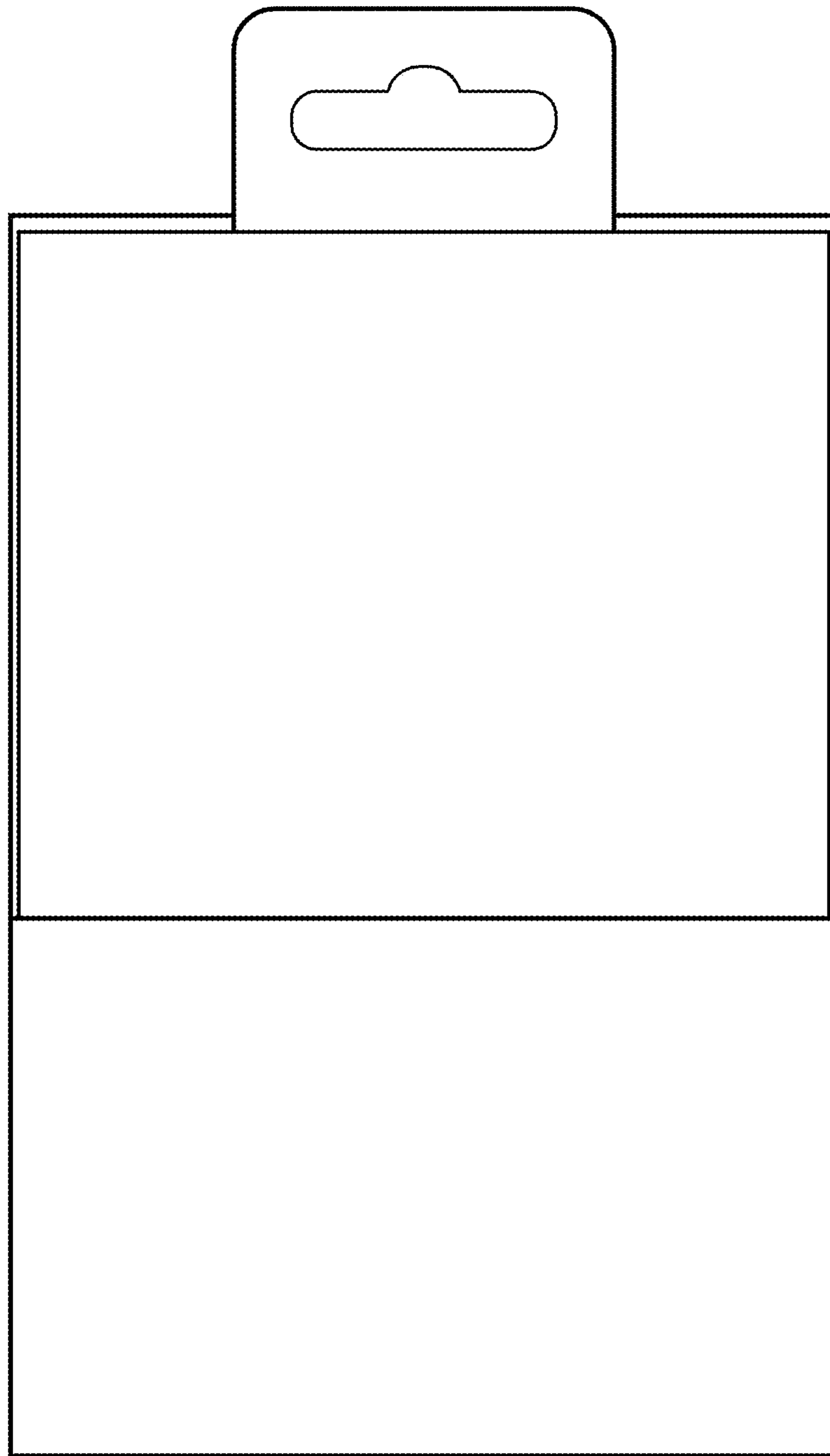

FIG. 37



FIG. 38

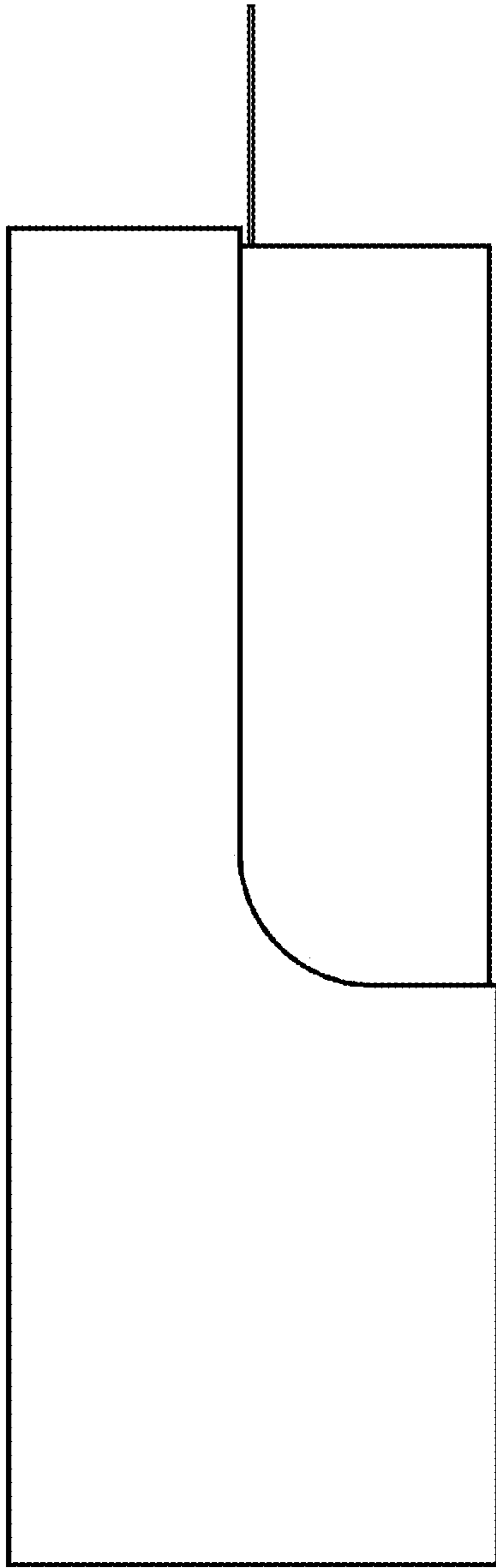

FIG. 39

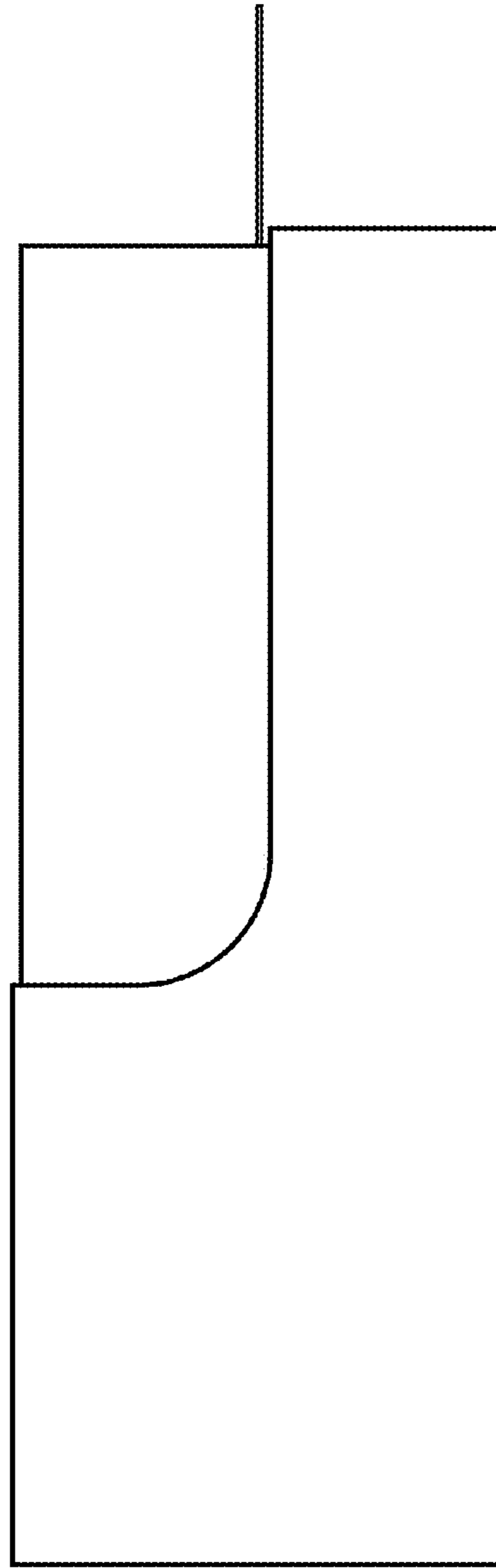

FIG. 40

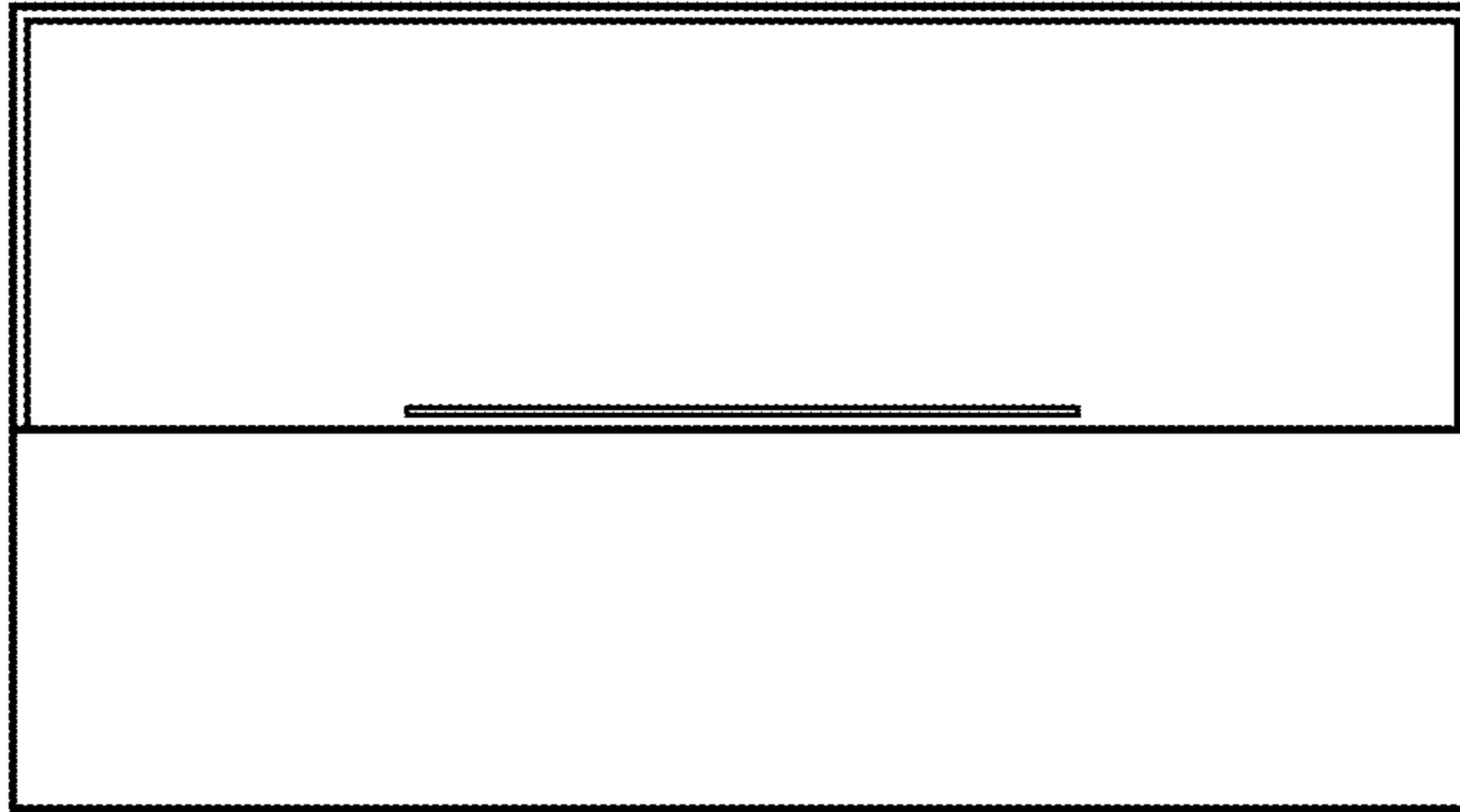

FIG. 41

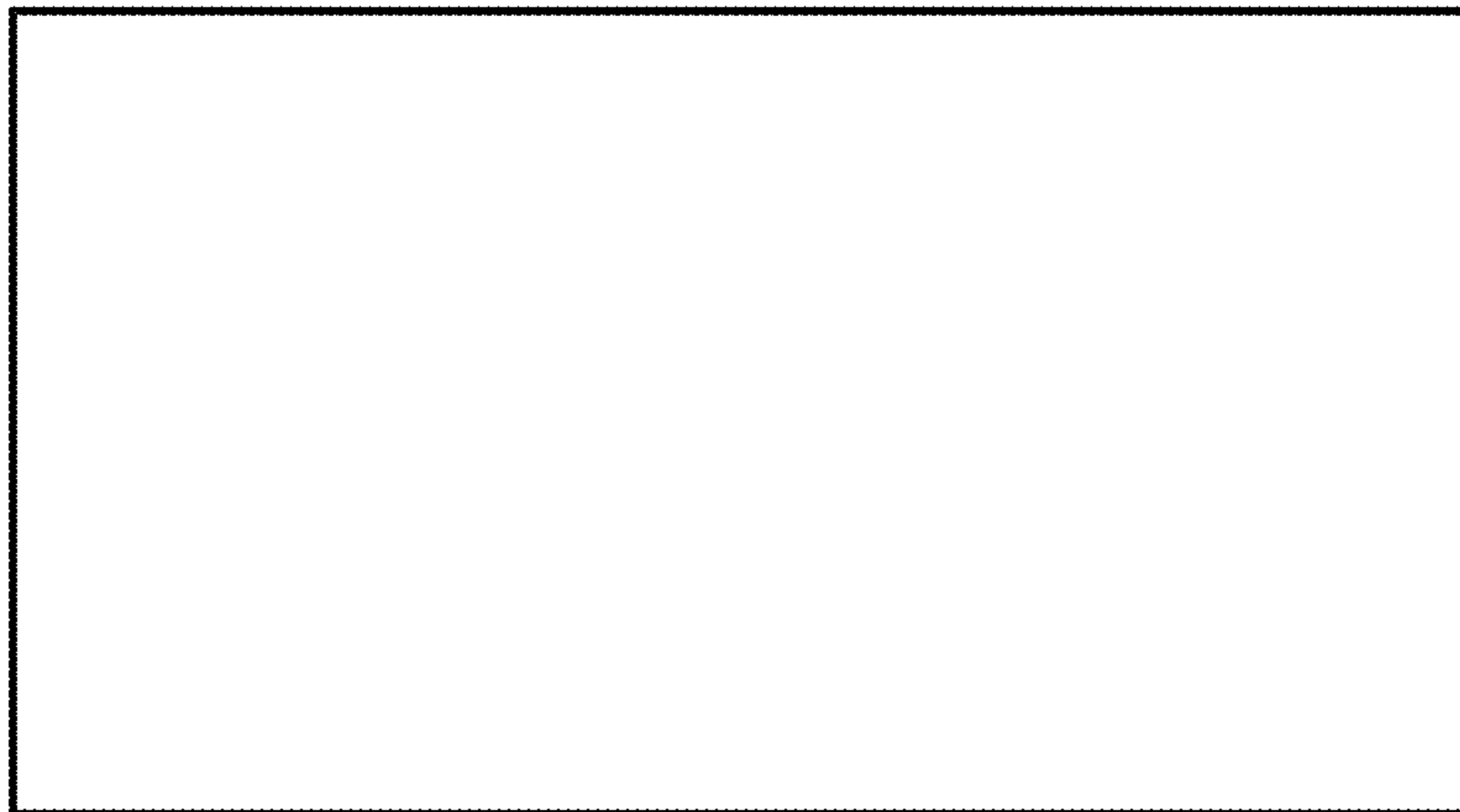

FIG. 42

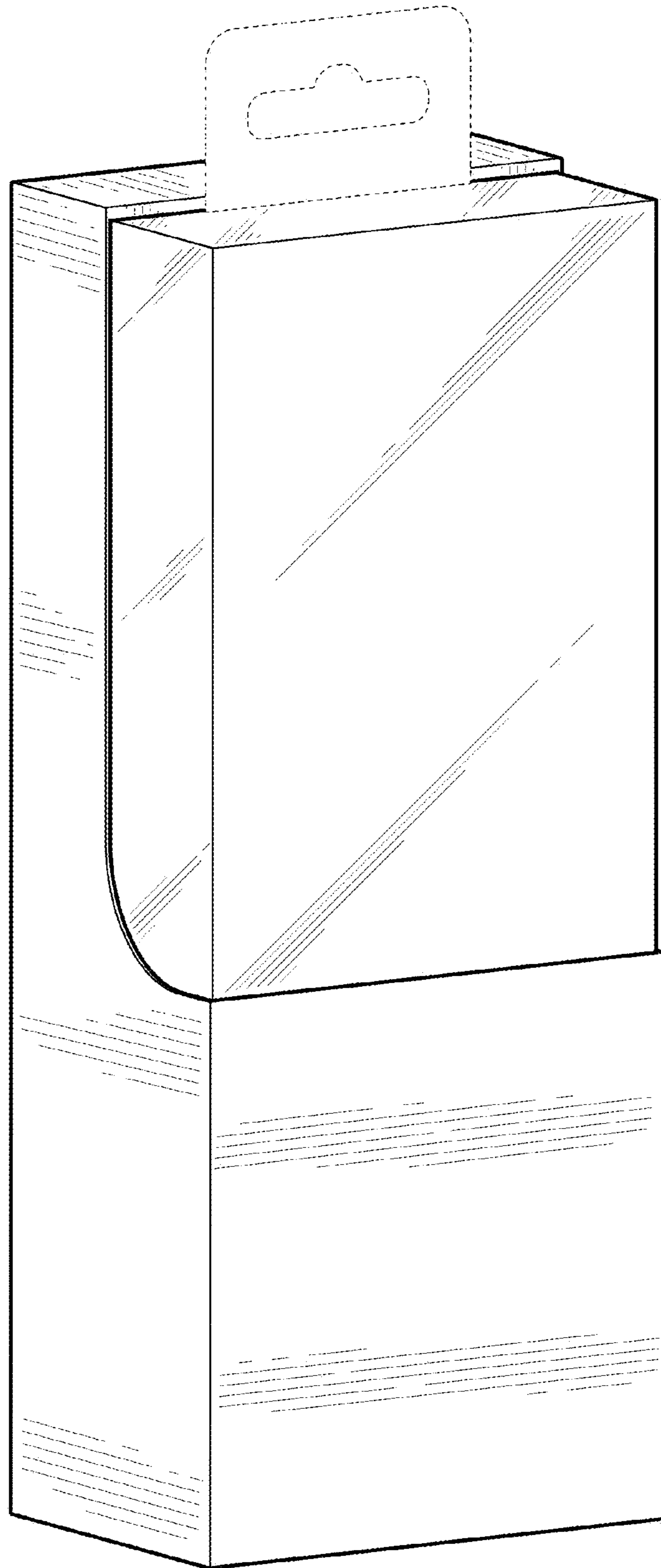

FIG. 43

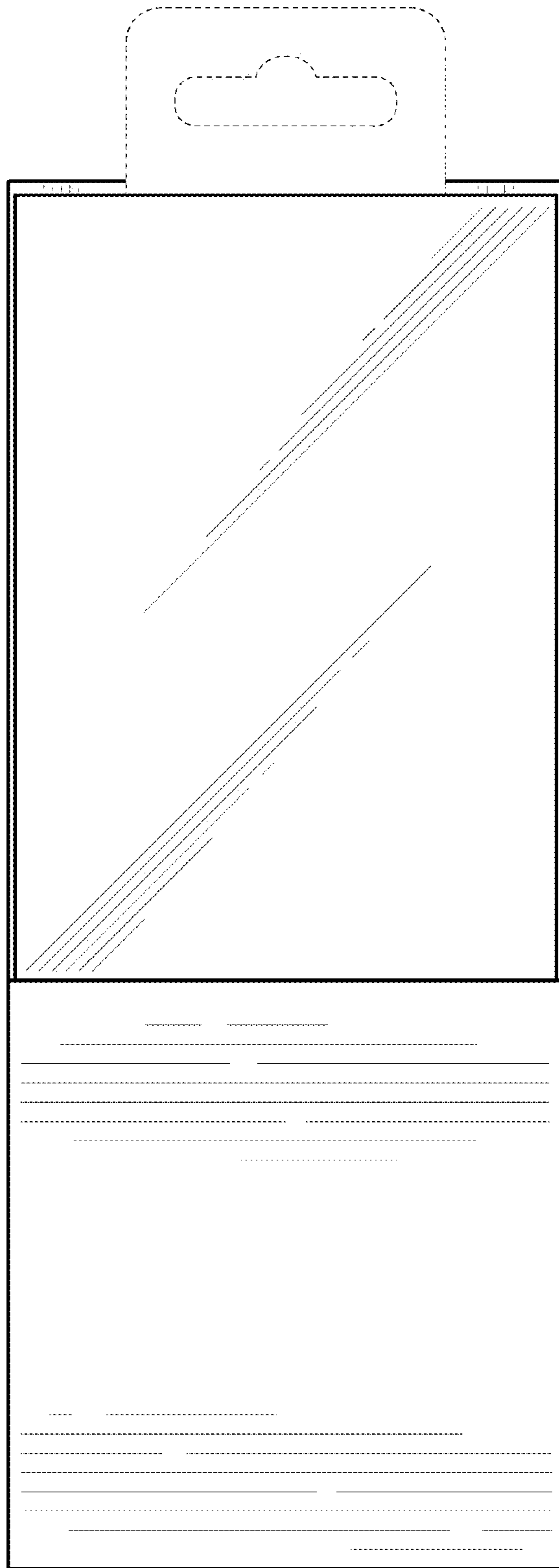

FIG. 44

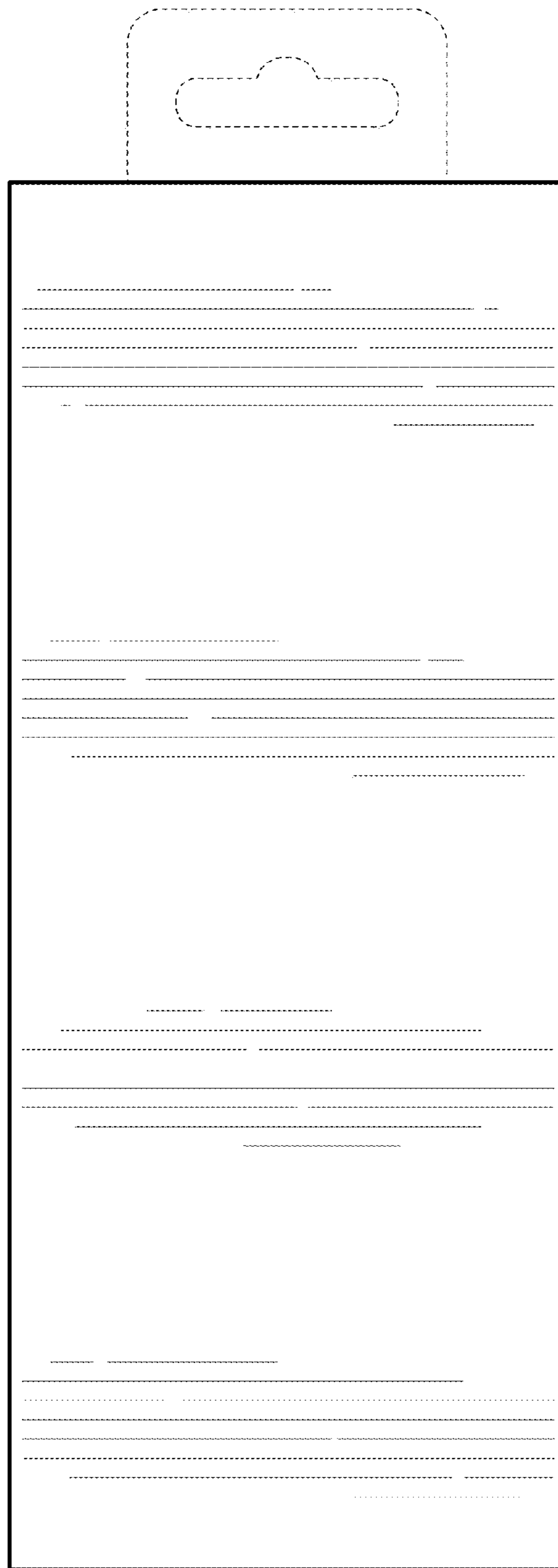

FIG. 45

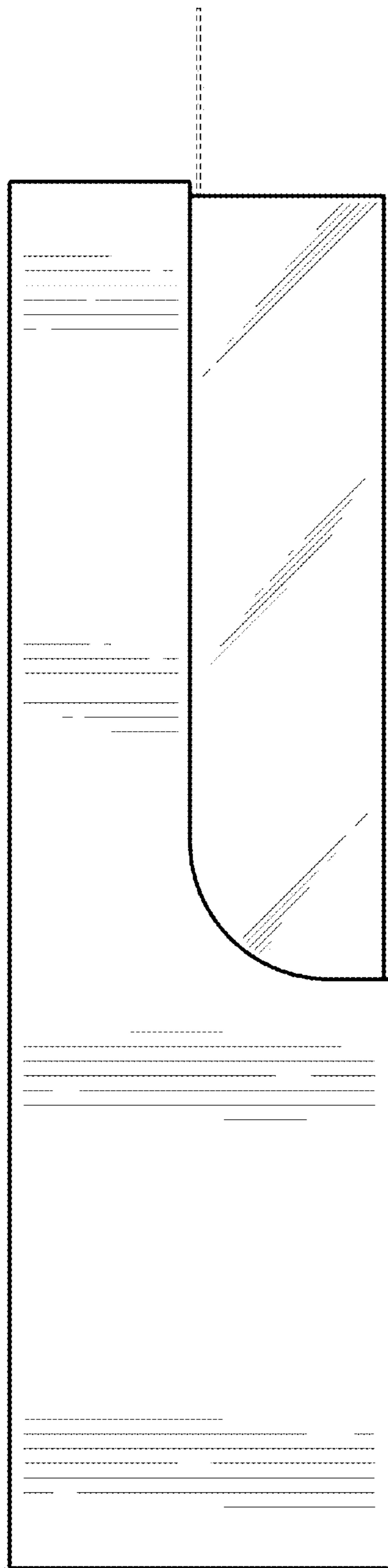

FIG. 46

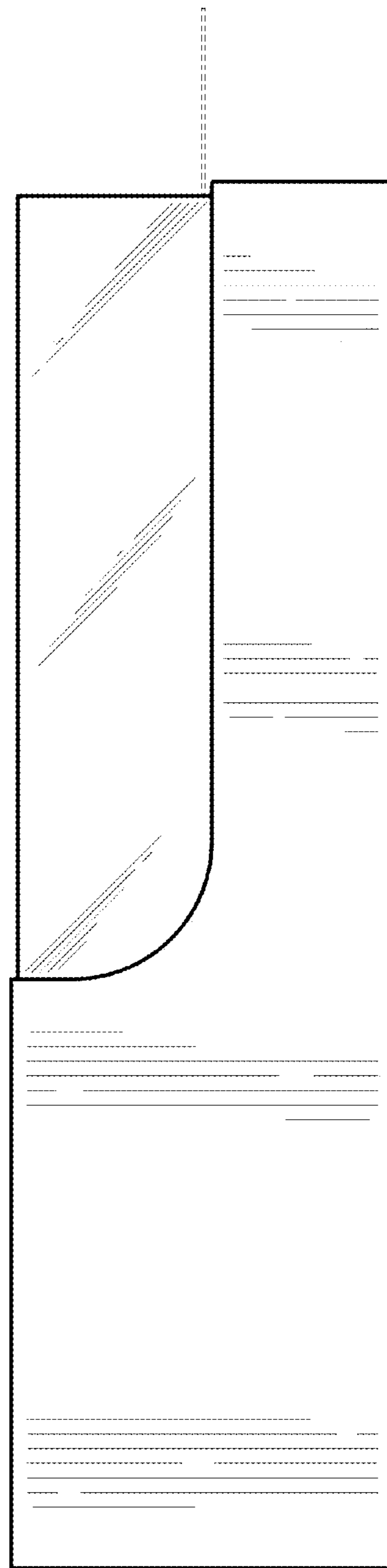

FIG. 47

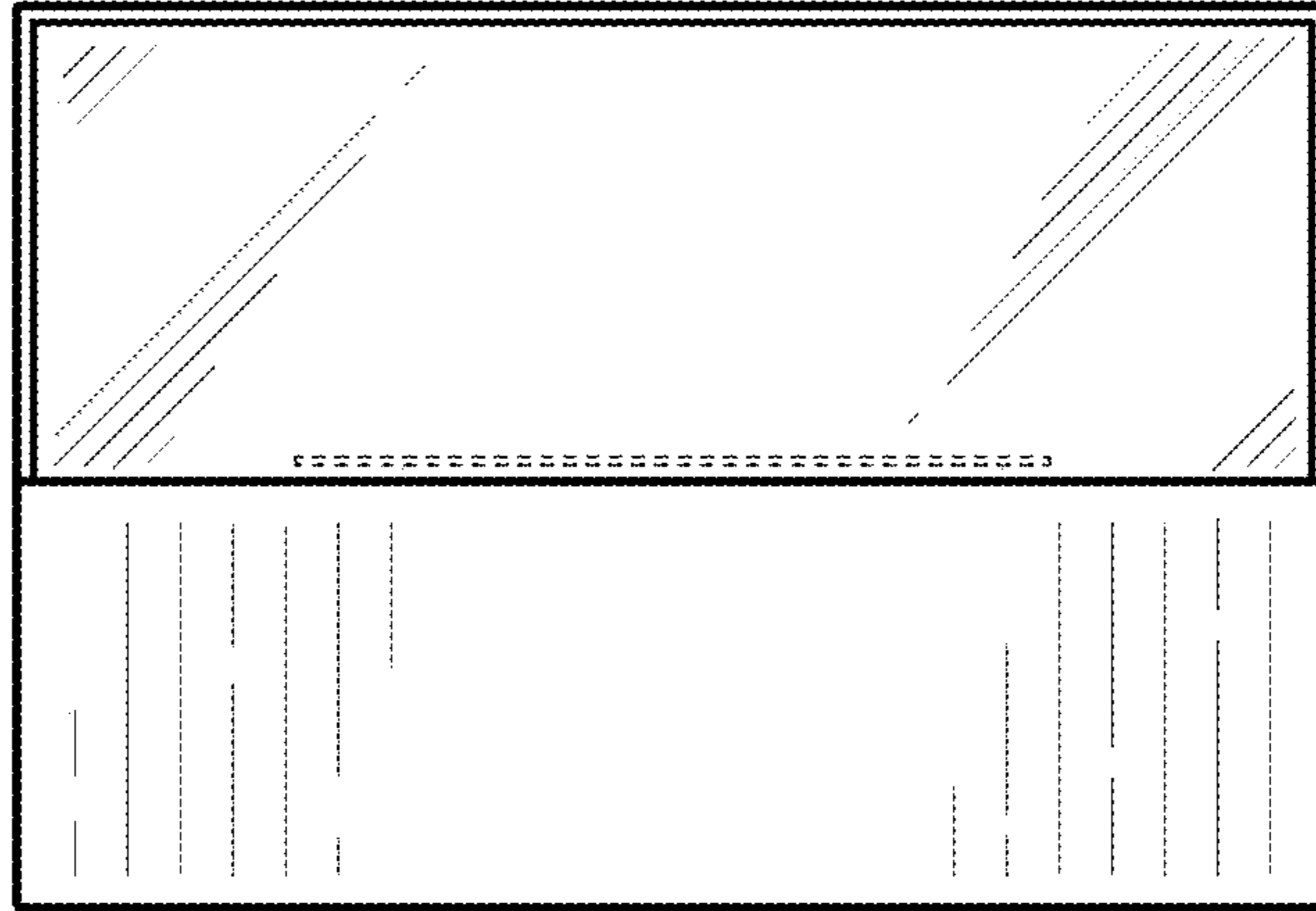

FIG. 48

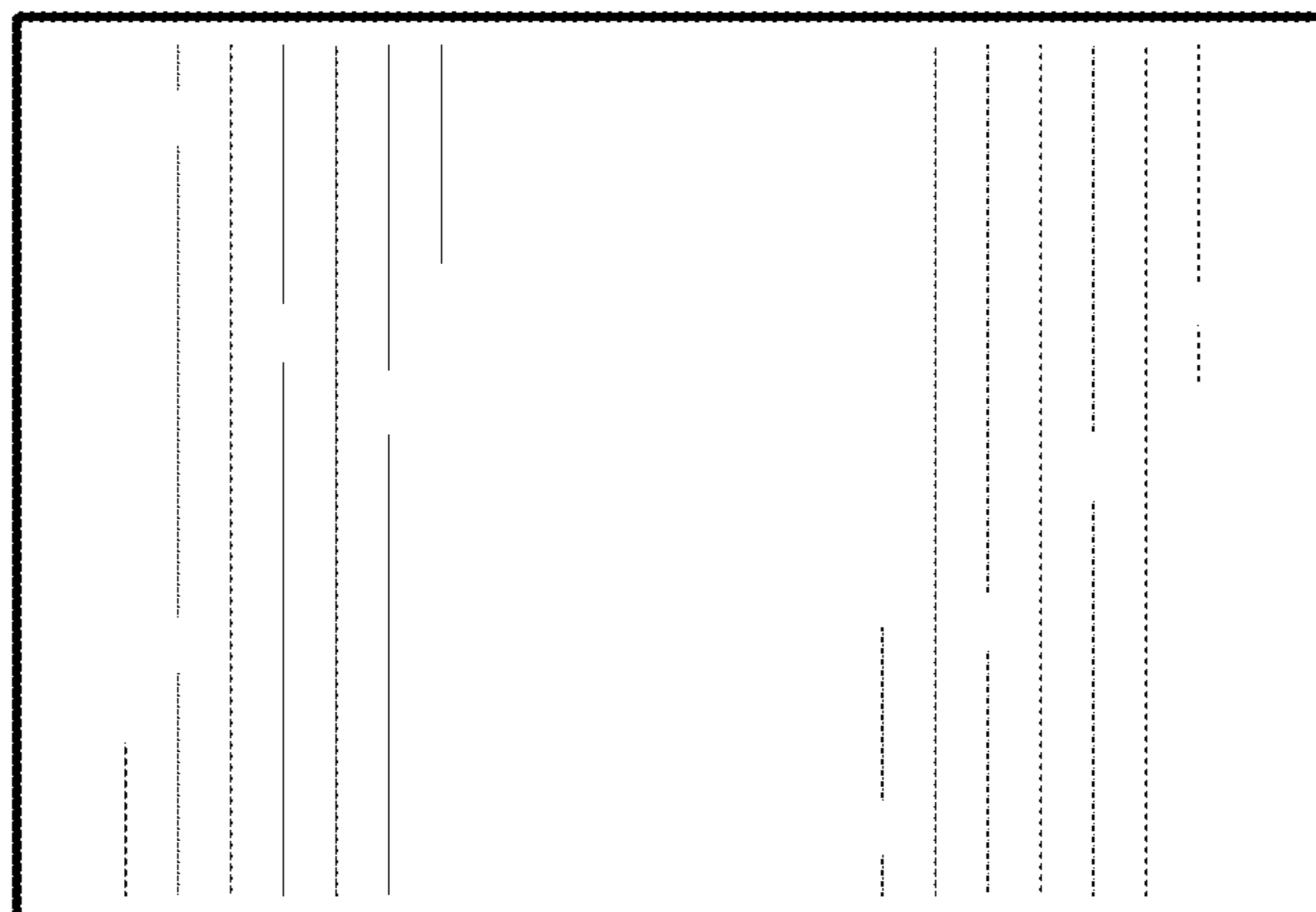

FIG. 49

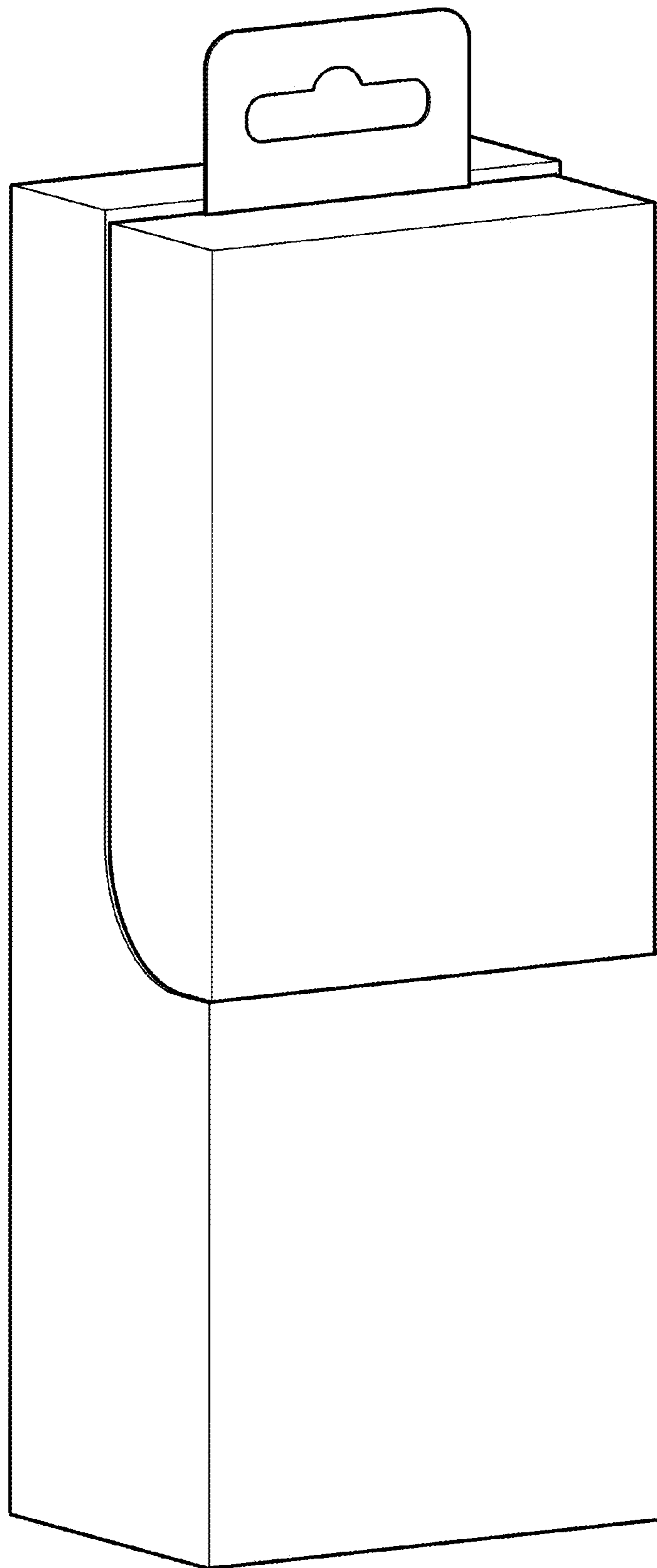

FIG. 50

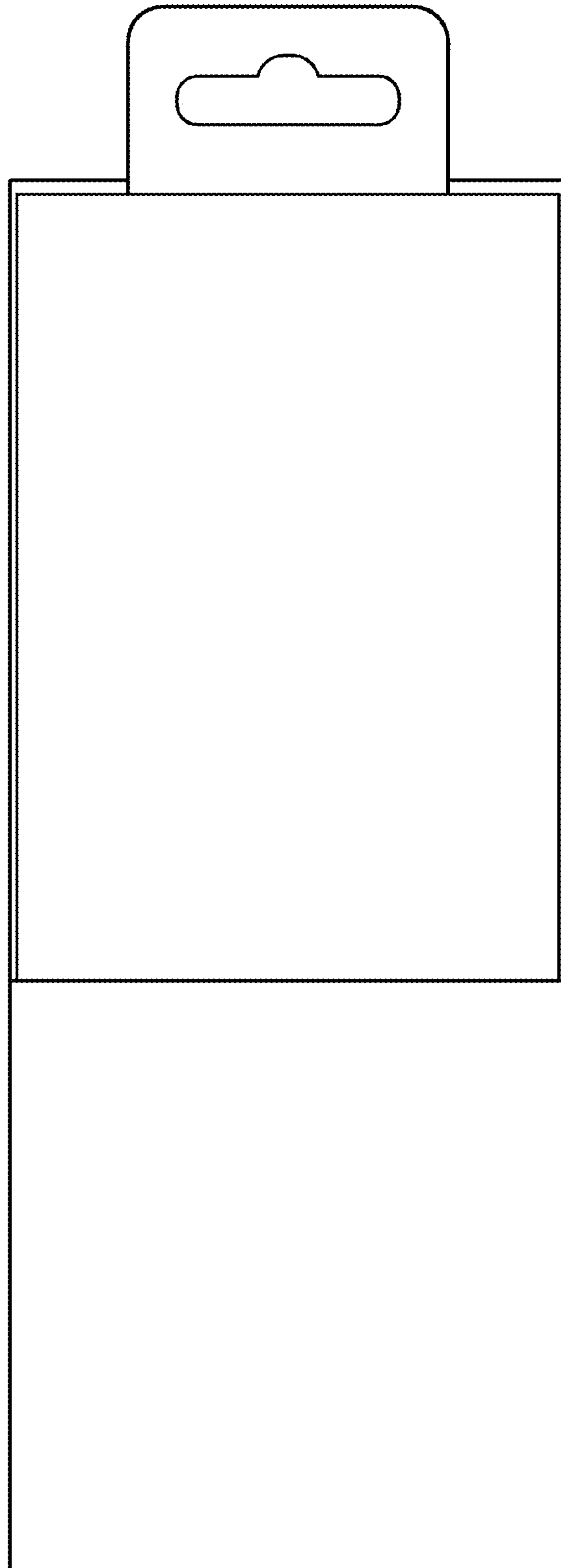

FIG. 51



FIG. 52

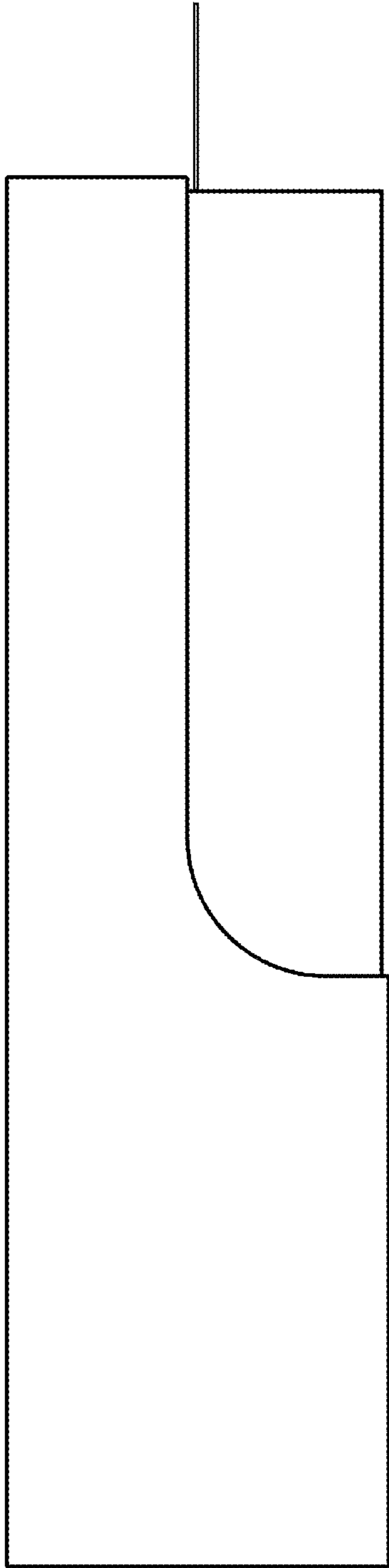

FIG. 53

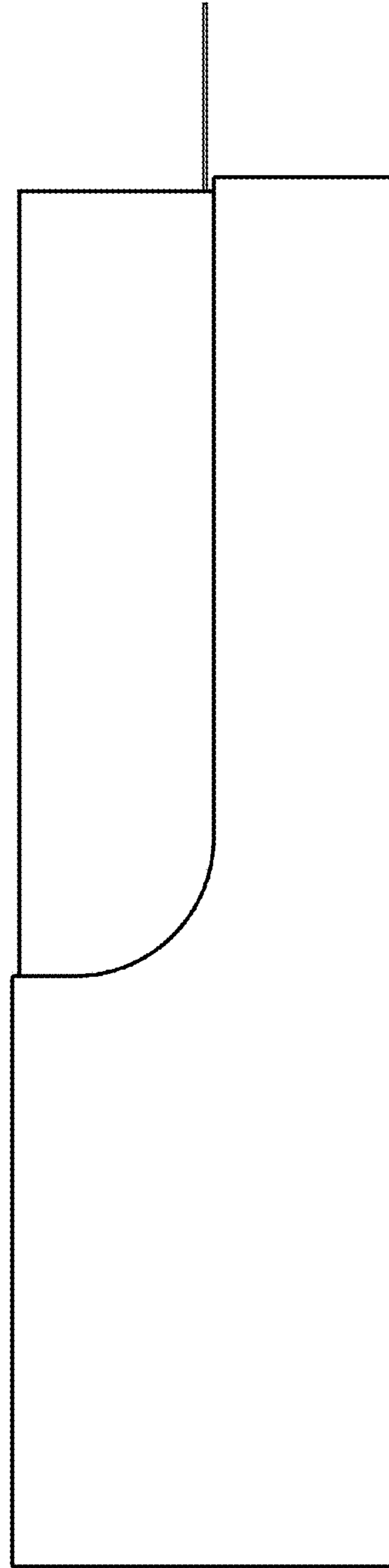

FIG. 54

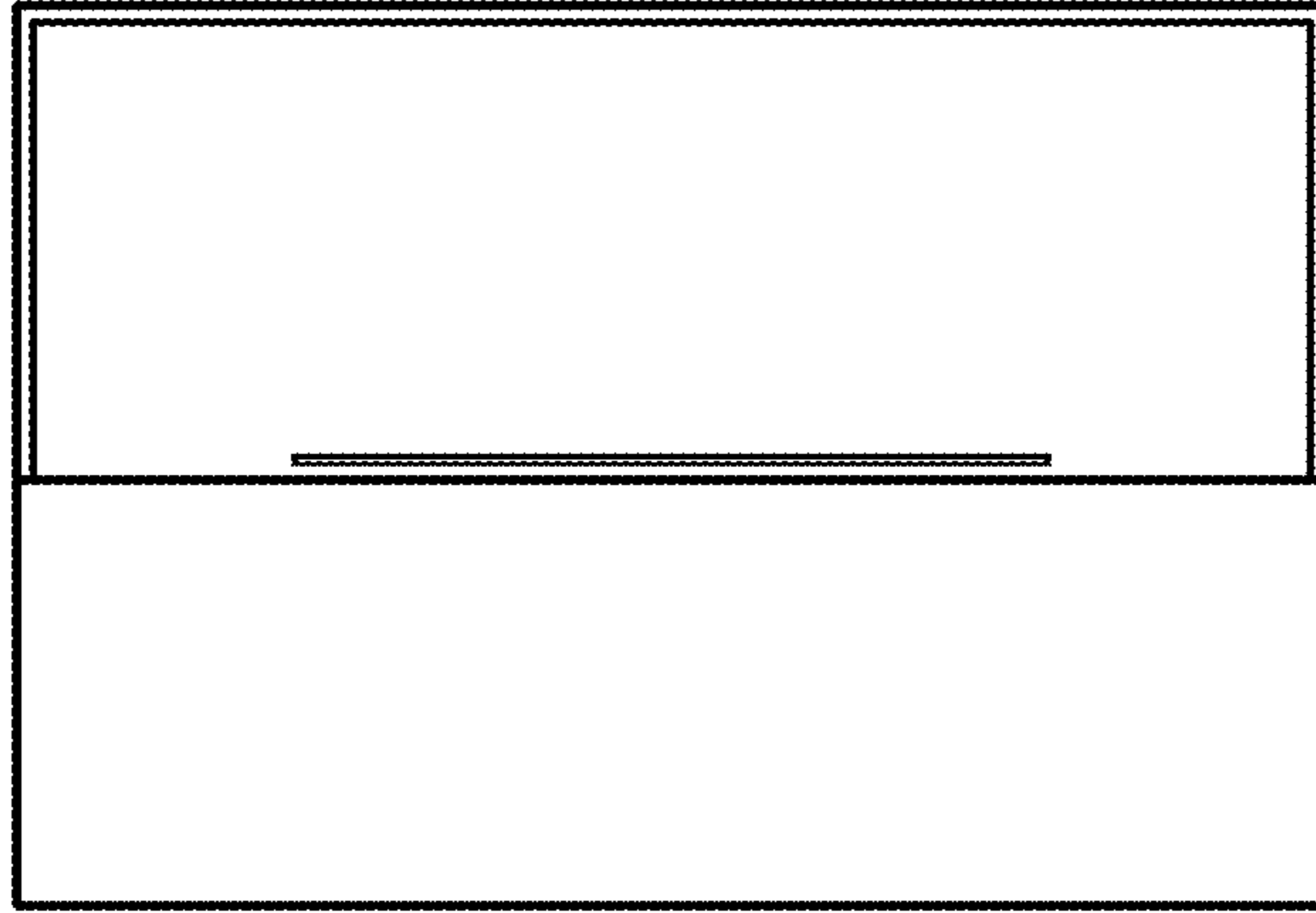

FIG. 55

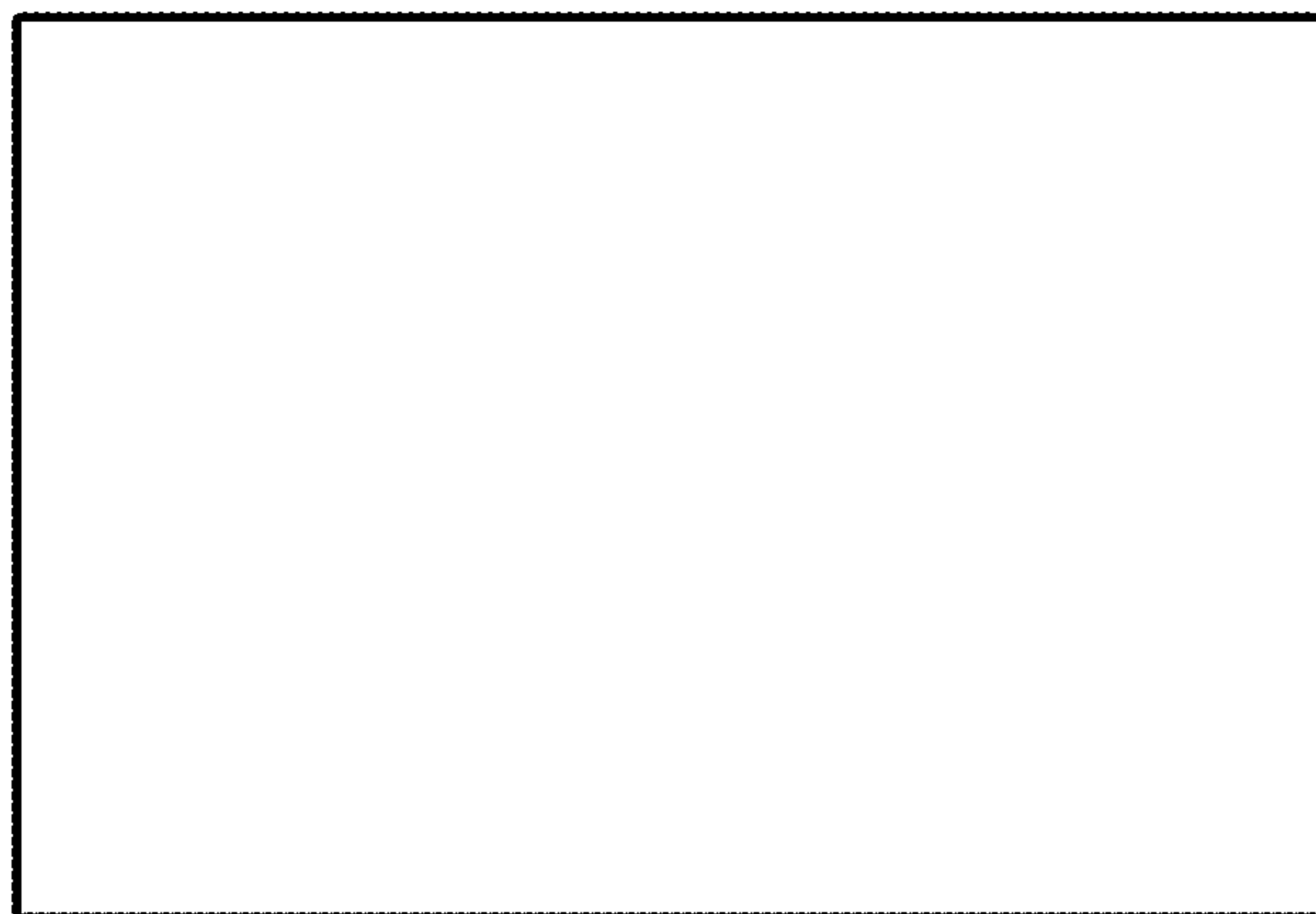

FIG. 56

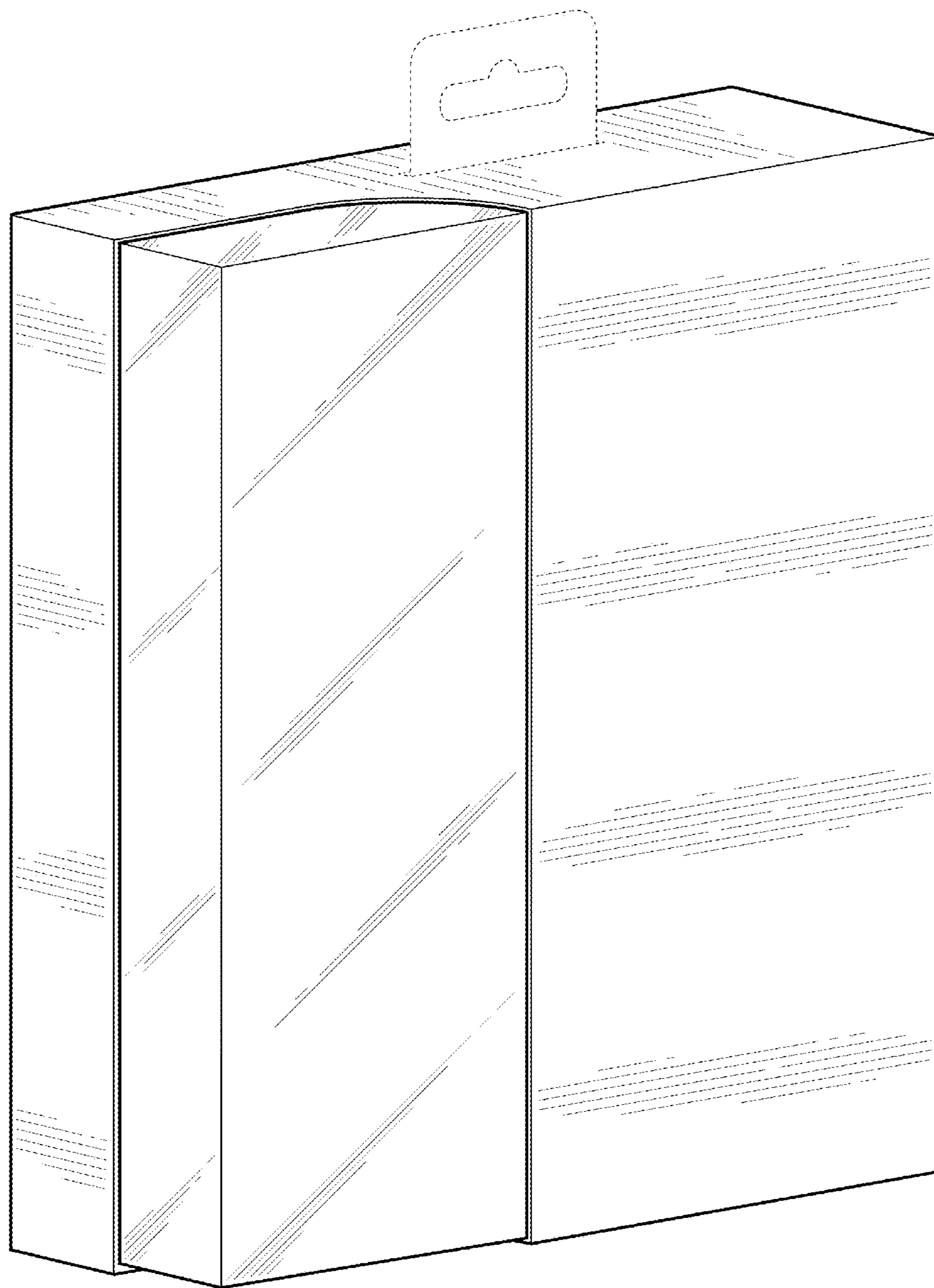

FIG. 57

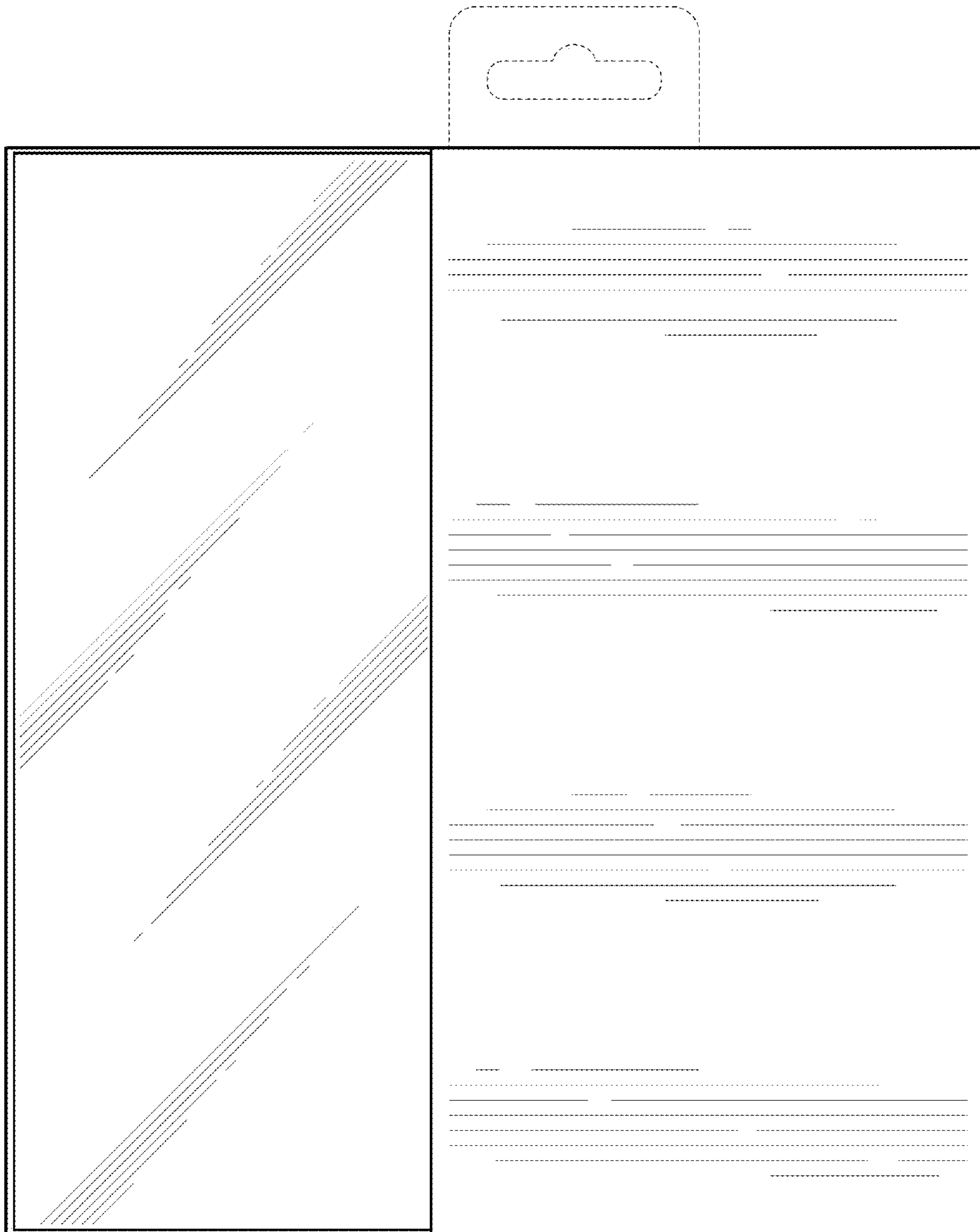

FIG. 58

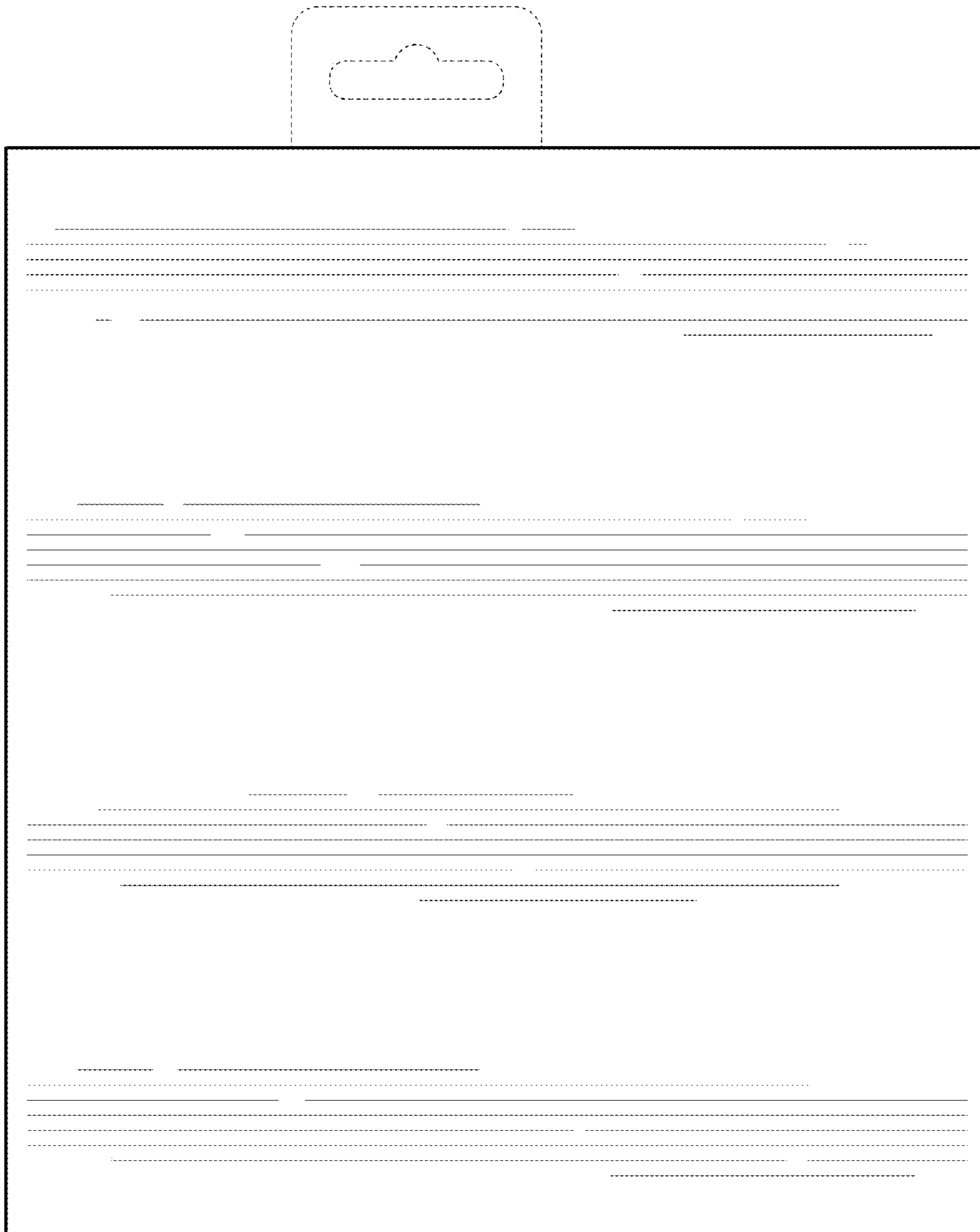

FIG. 59

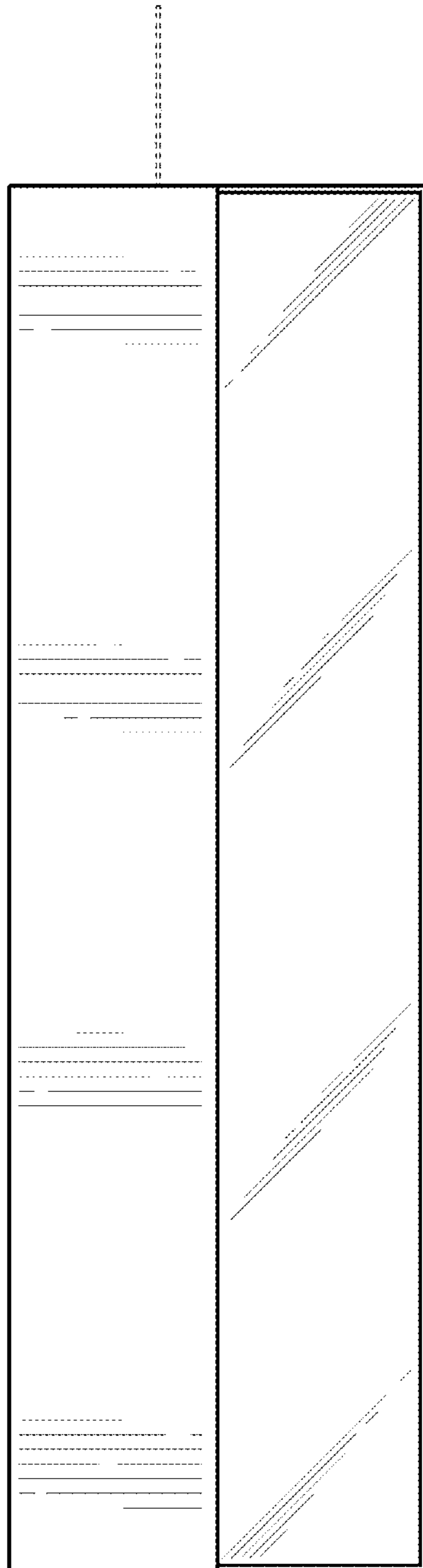

FIG. 60

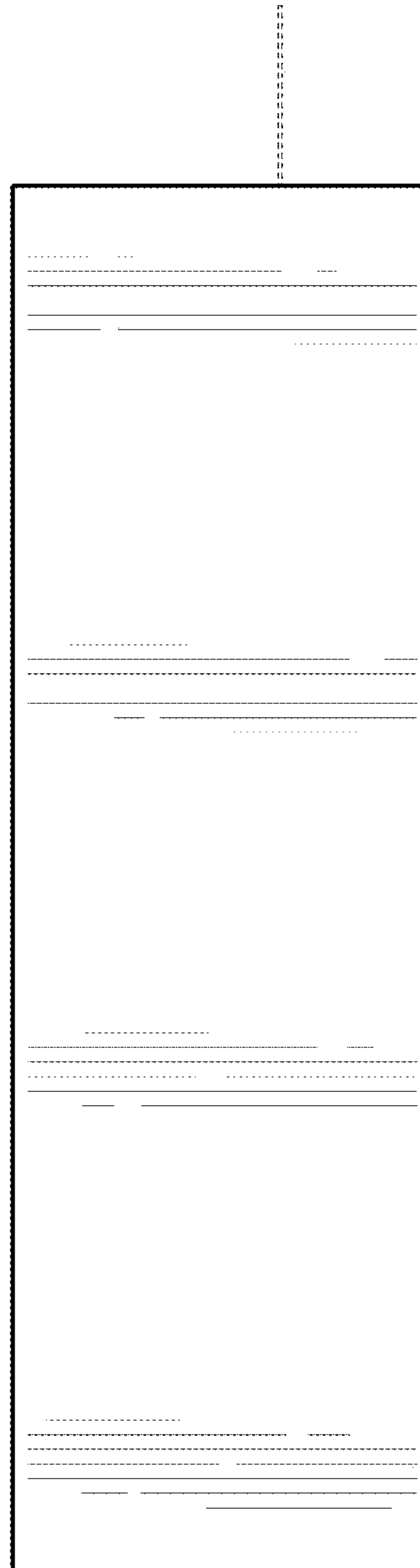

FIG. 61

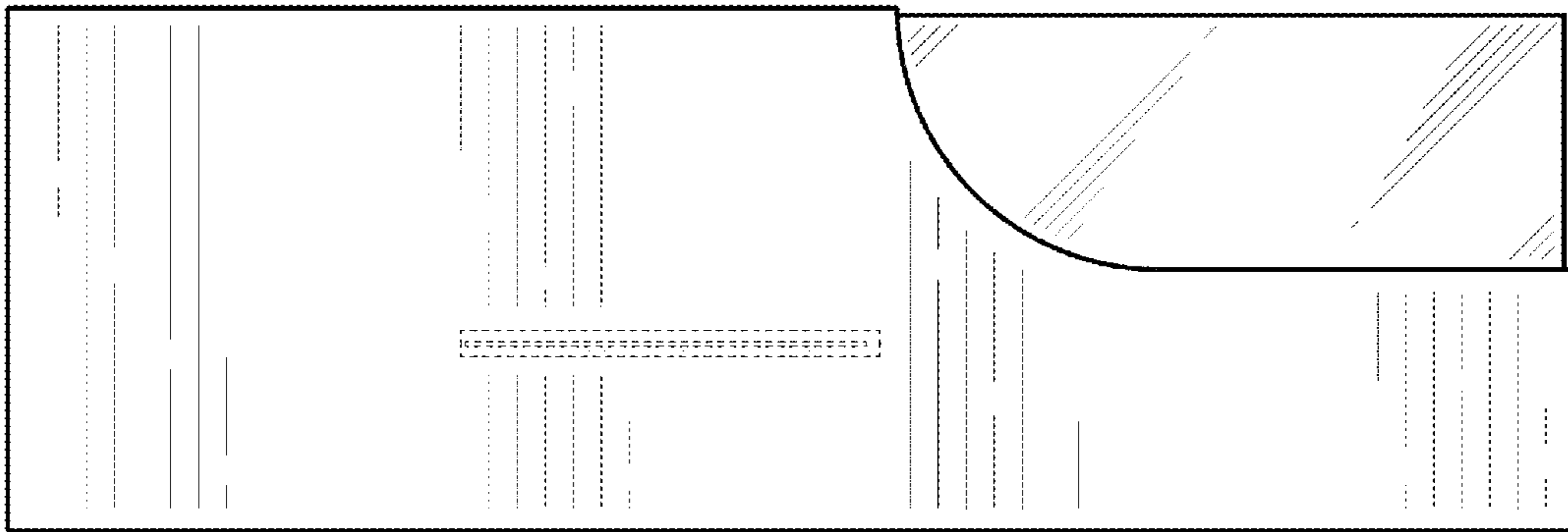

FIG. 62

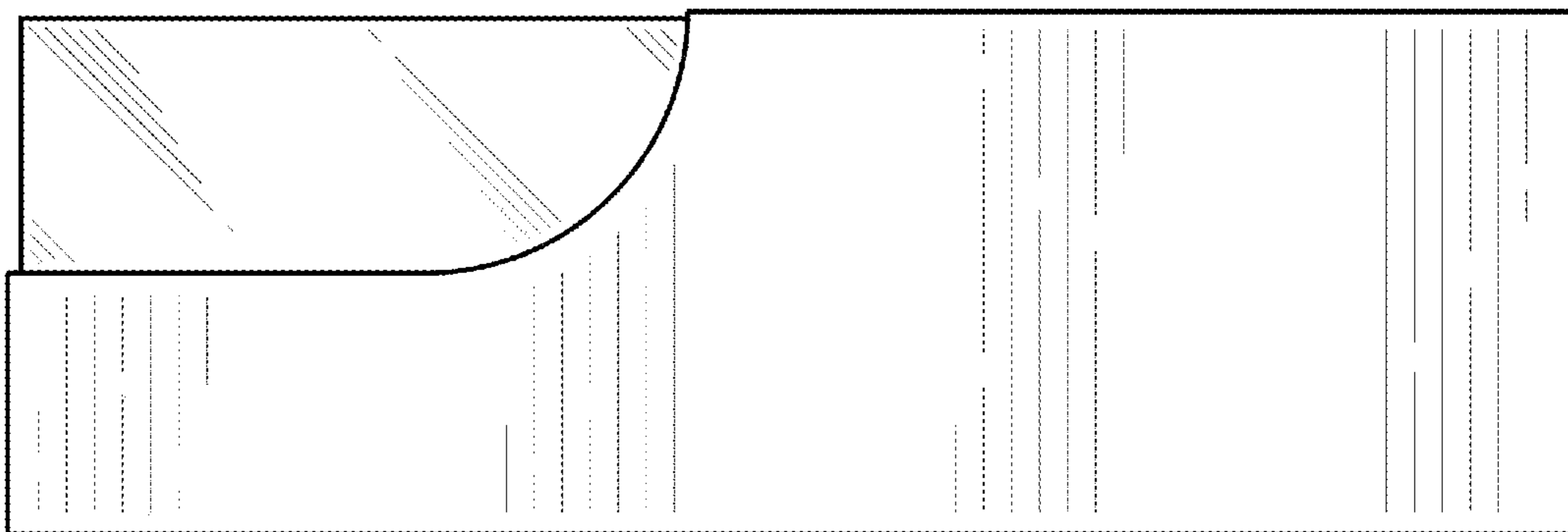

FIG. 63

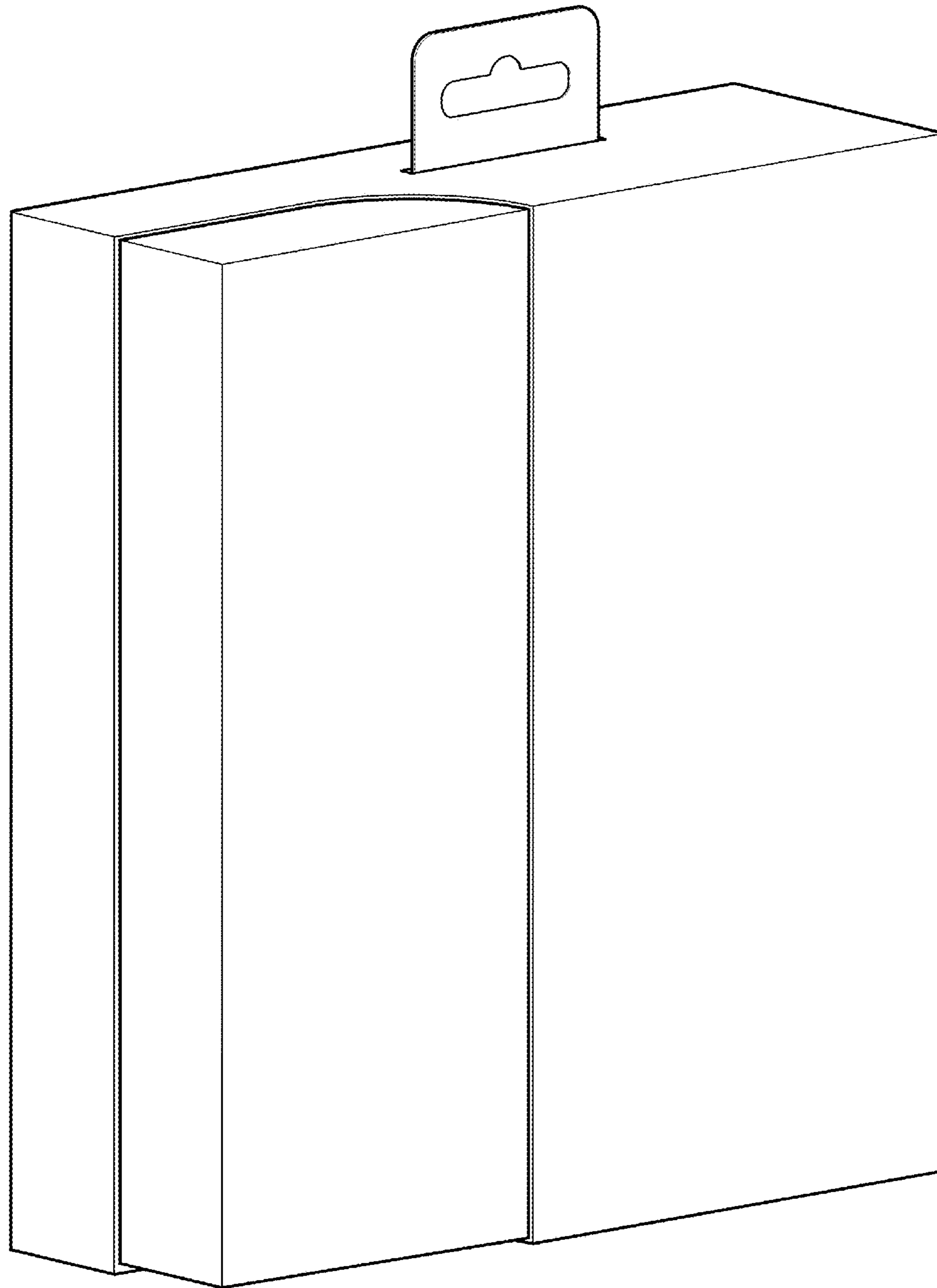

FIG. 64

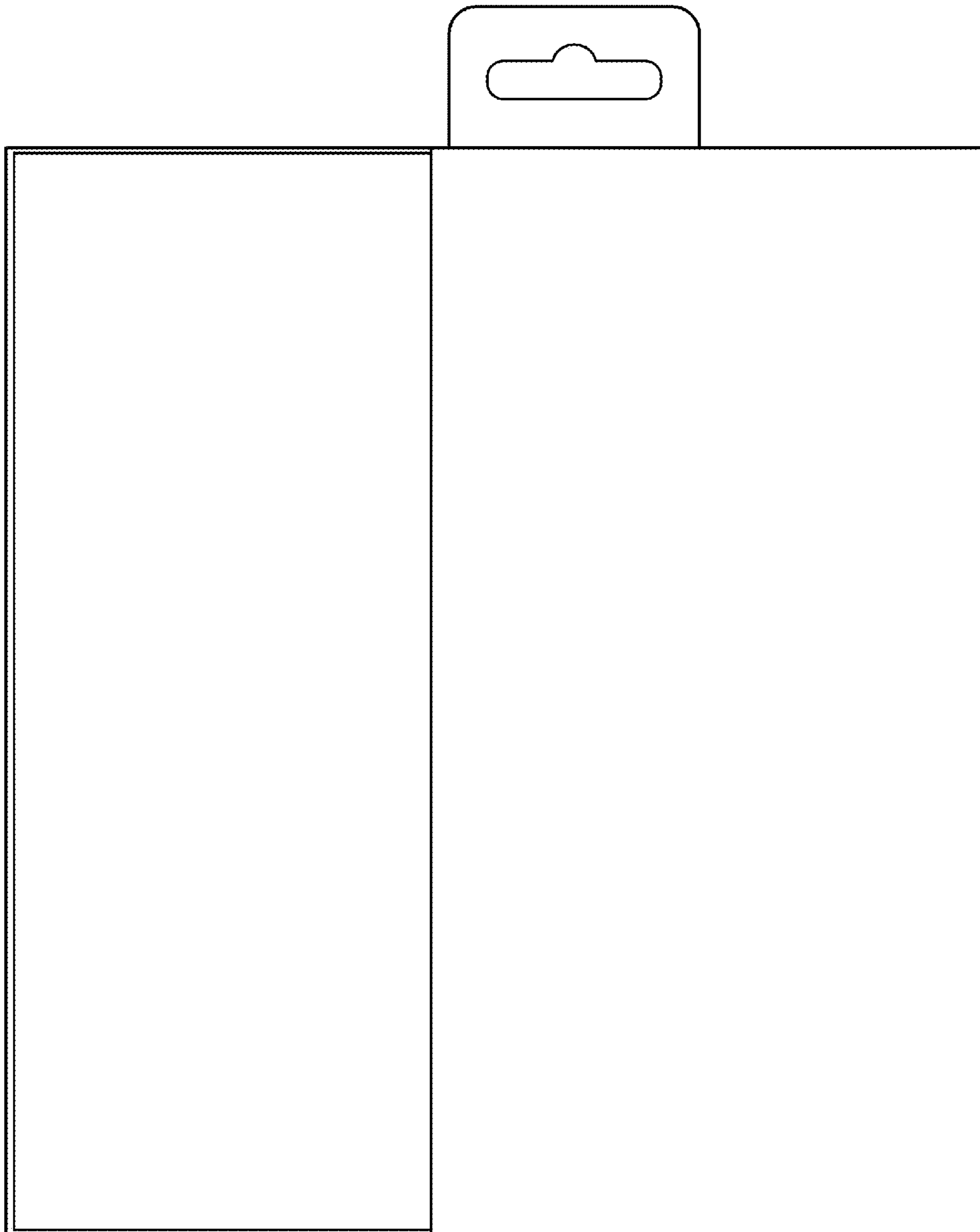

FIG. 65

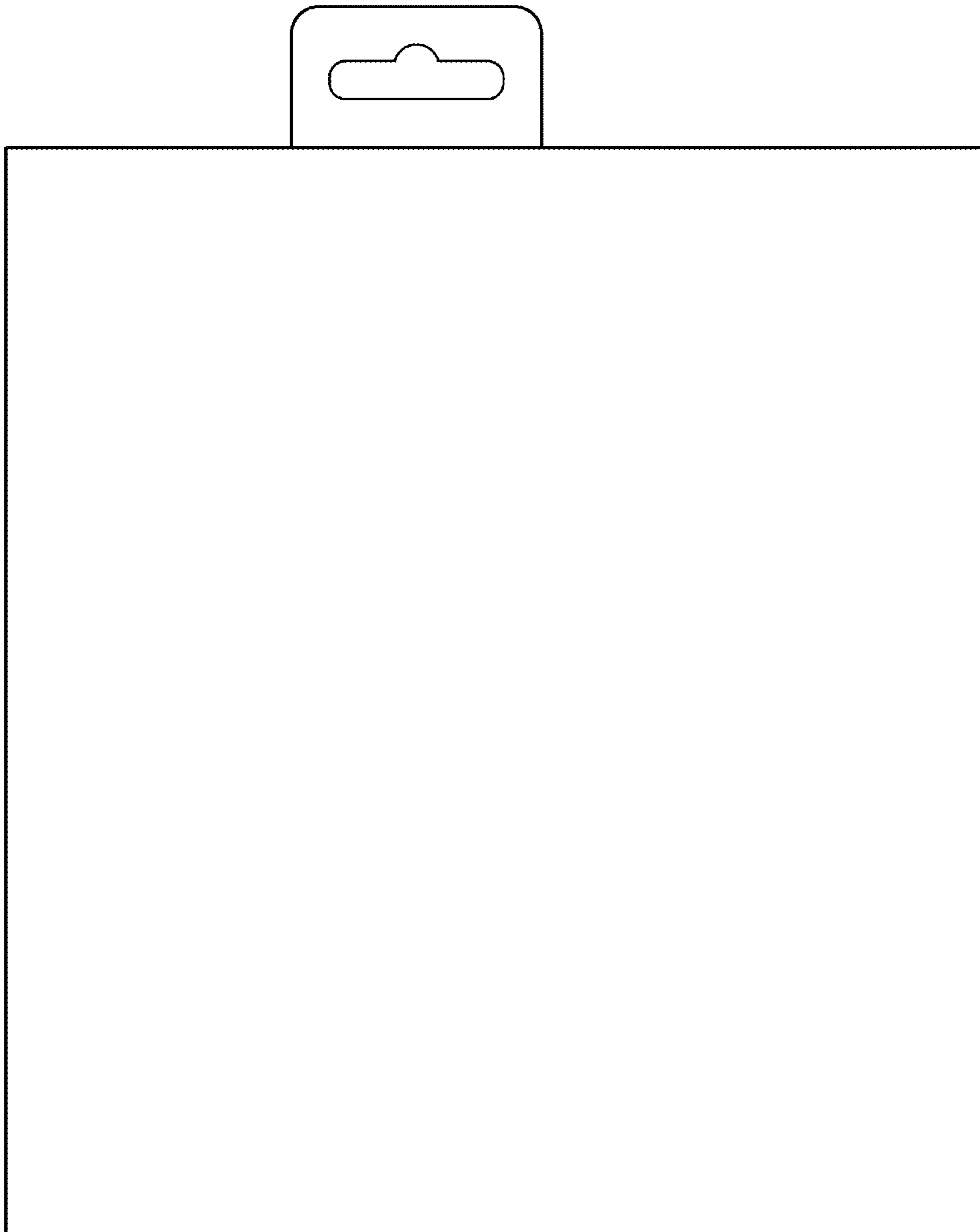

FIG. 66

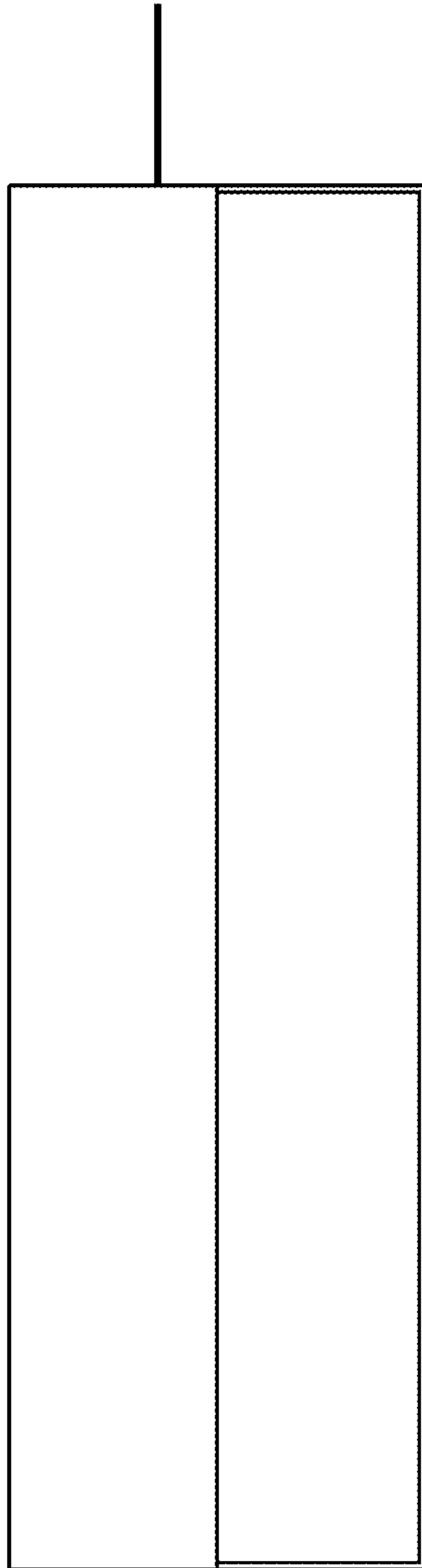

FIG. 67



FIG. 68

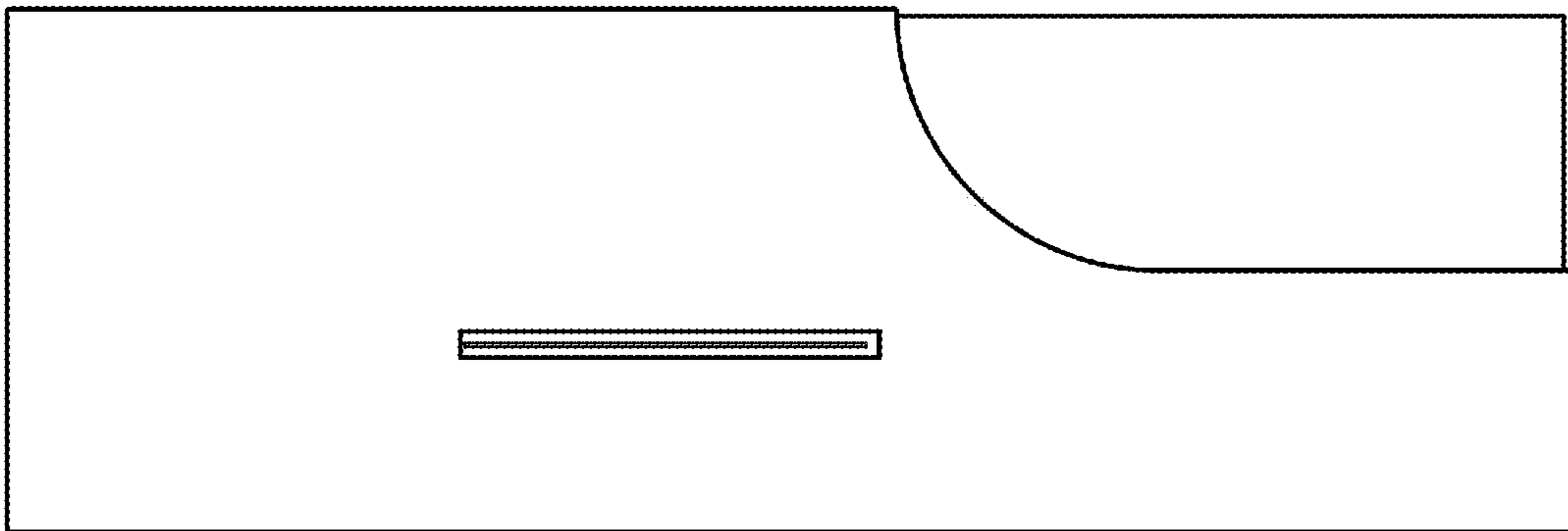

FIG. 69

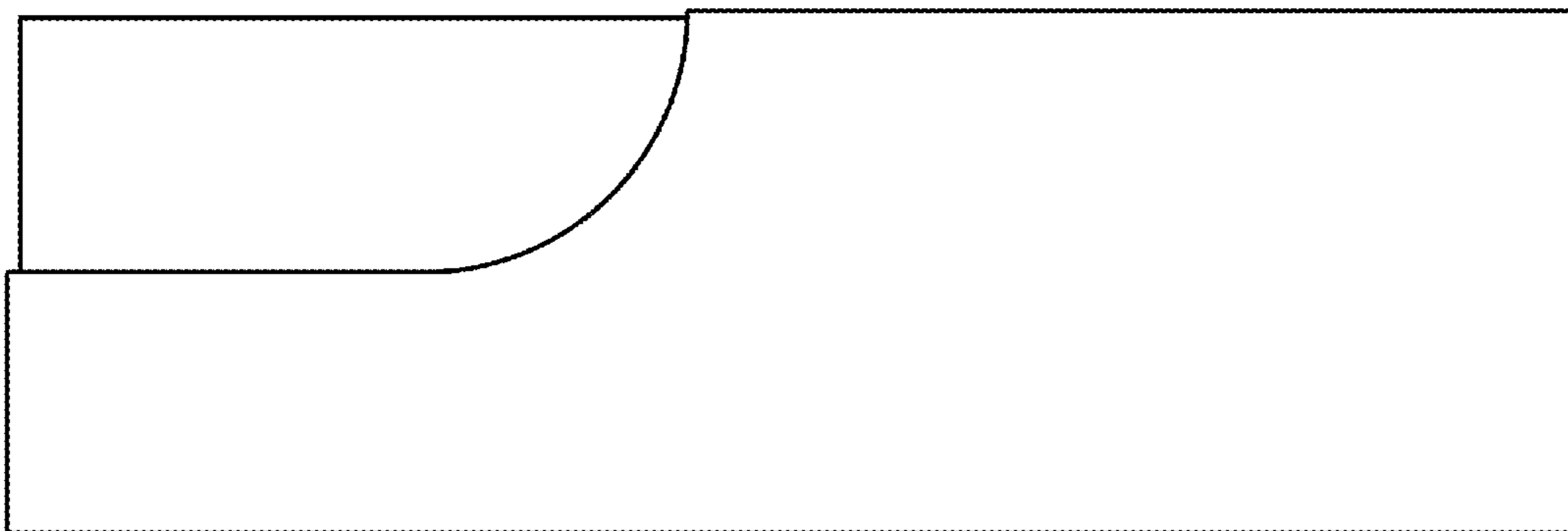

FIG. 70