



US00D681373S

(12) **United States Design Patent**  
**Okabe**

(10) **Patent No.:** **US D681,373 S**

(45) **Date of Patent:** **\*\* May 7, 2013**

(54) **TABLE**

(75) Inventor: **Noriaki Okabe**, Tokyo (JP)

(73) Assignee: **Okamura Corporation**, Kanagawa (JP)

(\*\*) Term: **14 Years**

(21) Appl. No.: **29/418,889**

(22) Filed: **Apr. 23, 2012**

(30) **Foreign Application Priority Data**

Oct. 24, 2011 (JP) ..... 2011-024371

(51) **LOC (9) Cl.** ..... **06-06**

(52) **U.S. Cl.**

USPC ..... **D6/495**

(58) **Field of Classification Search** ..... D6/480-489,  
D6/495, 496, 499, 429, 680, 68.2; 108/150,  
108/153.1, 155, 157, 161; 248/188, 188.8,  
248/188.7

See application file for complete search history.

(56) **References Cited**

U.S. PATENT DOCUMENTS

D166,830 S \* 5/1952 Shinn ..... D6/495  
D240,871 S \* 8/1976 Herman ..... D6/485  
D243,306 S \* 2/1977 Moyer ..... D6/495

\* cited by examiner

*Primary Examiner* — Janice Seeger

(74) *Attorney, Agent, or Firm* — Sughrue Mion, PLLC

(57) **CLAIM**

The ornamental design for a table, as shown and described.

**DESCRIPTION**

FIG. 1 is a perspective view of a table.  
FIG. 2 is a perspective view thereof.  
FIG. 3 is a perspective view from the bottom thereof.  
FIG. 4 is a front elevation view thereof.  
FIG. 5 is a right side elevation view thereof. A left side elevation view is a mirror image of the right side elevation view.  
FIG. 6 is a top plan view thereof.  
FIG. 7 is a rear elevation view thereof; and,  
FIG. 8 is a bottom plan view thereof.  
The portions of the table shown in broken lines are for the purpose of showing environmental structure only and form no part of the claimed design.

**1 Claim, 8 Drawing Sheets**

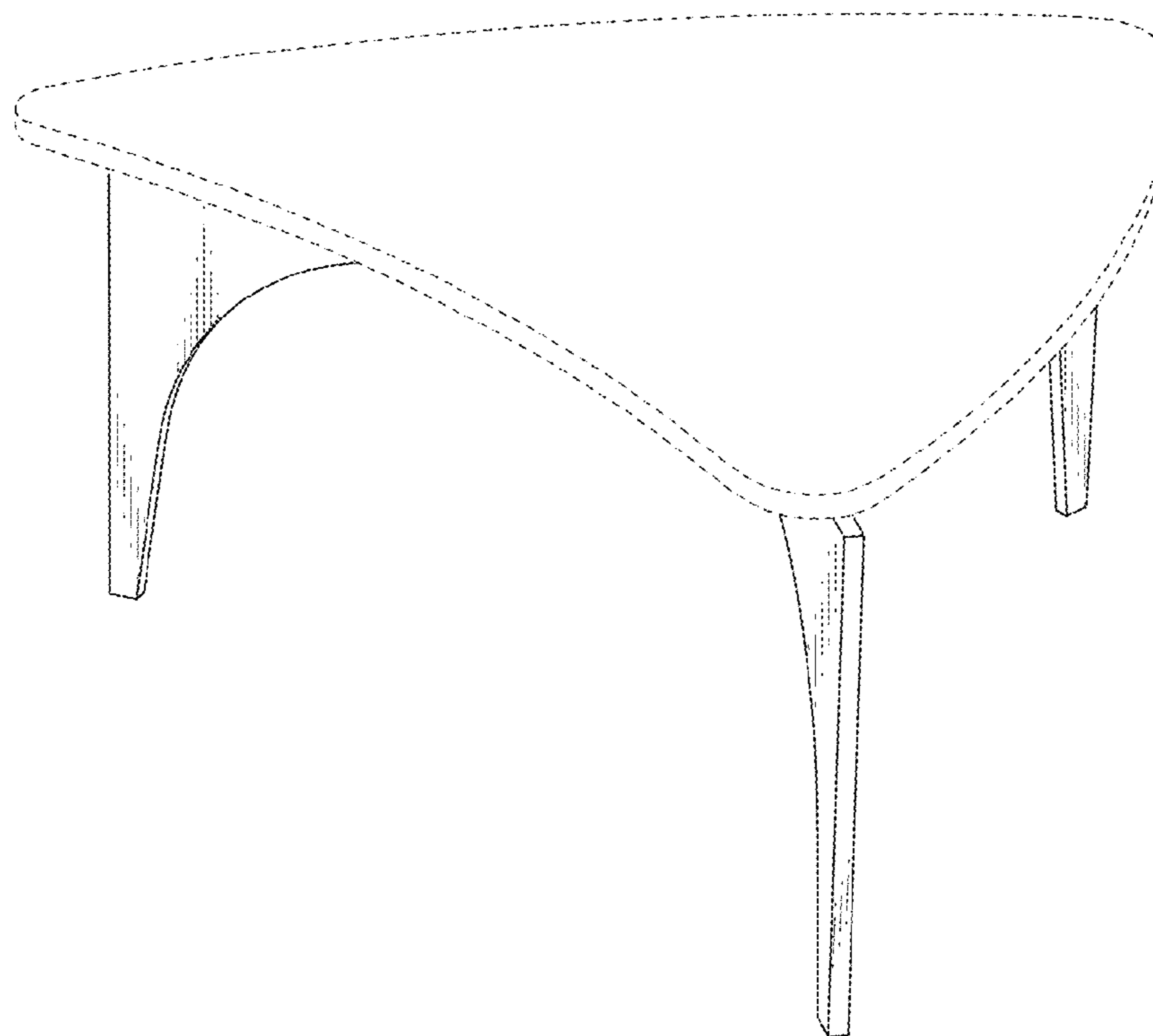

FIG. 1

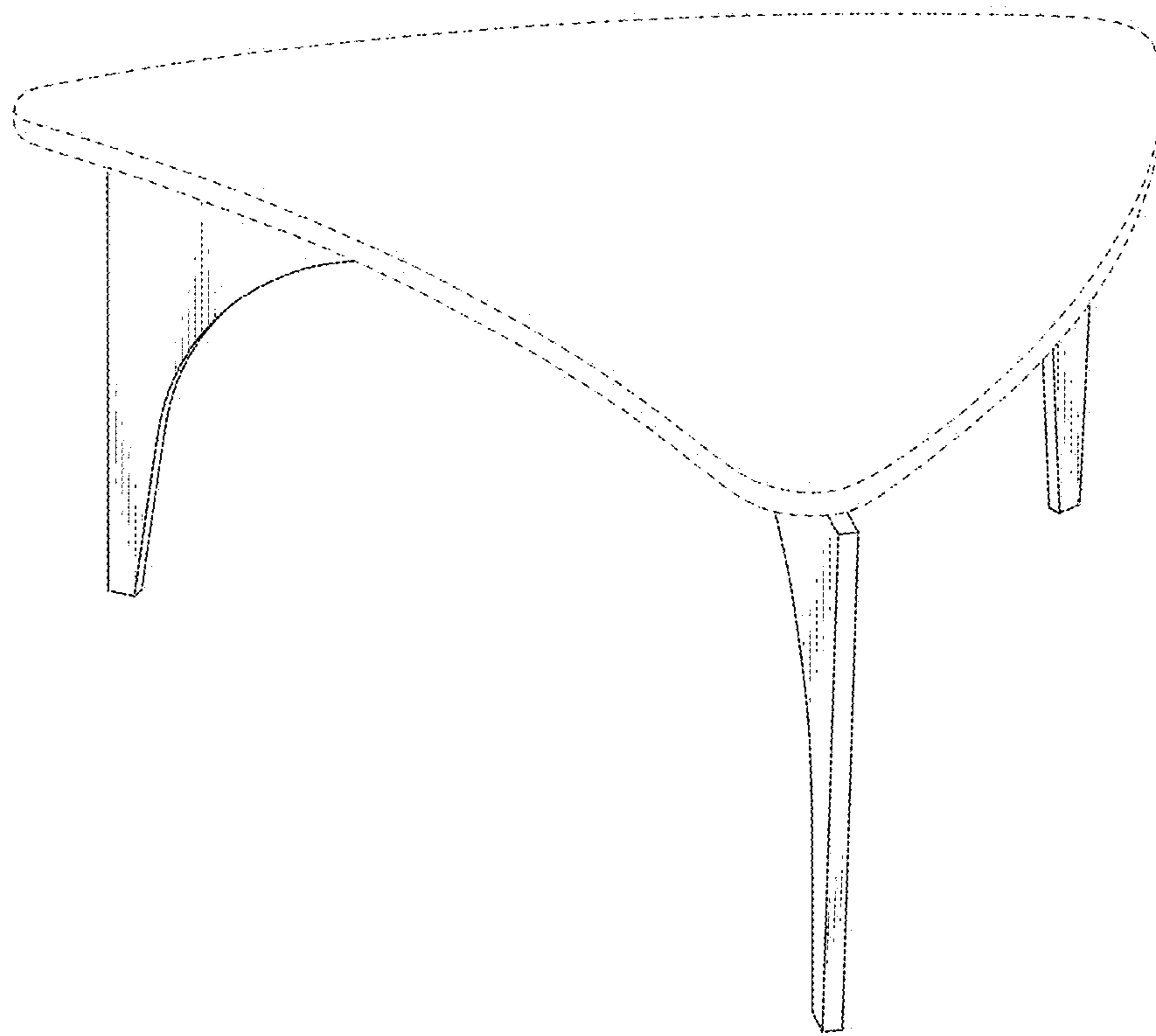

FIG. 2

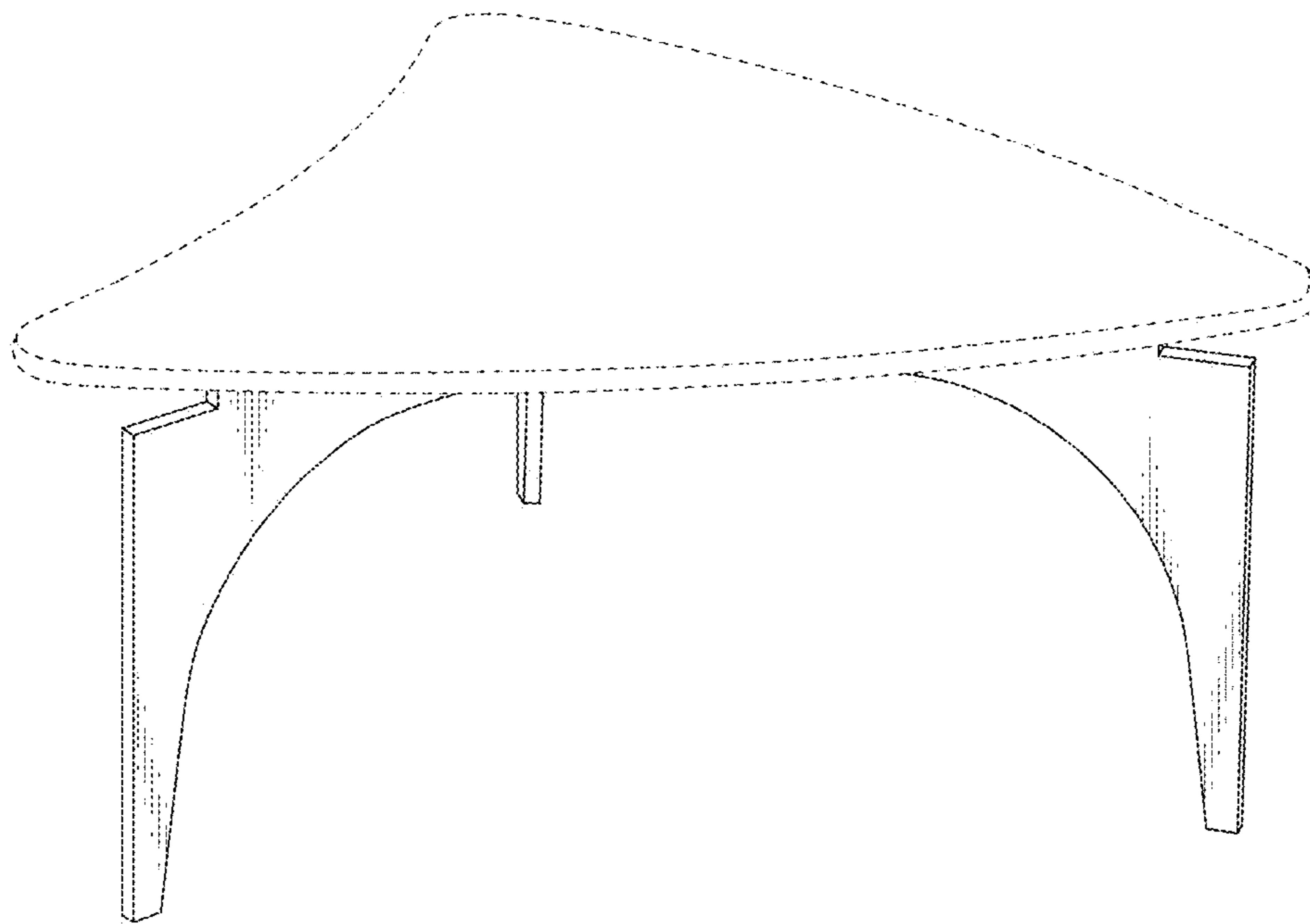

FIG. 3

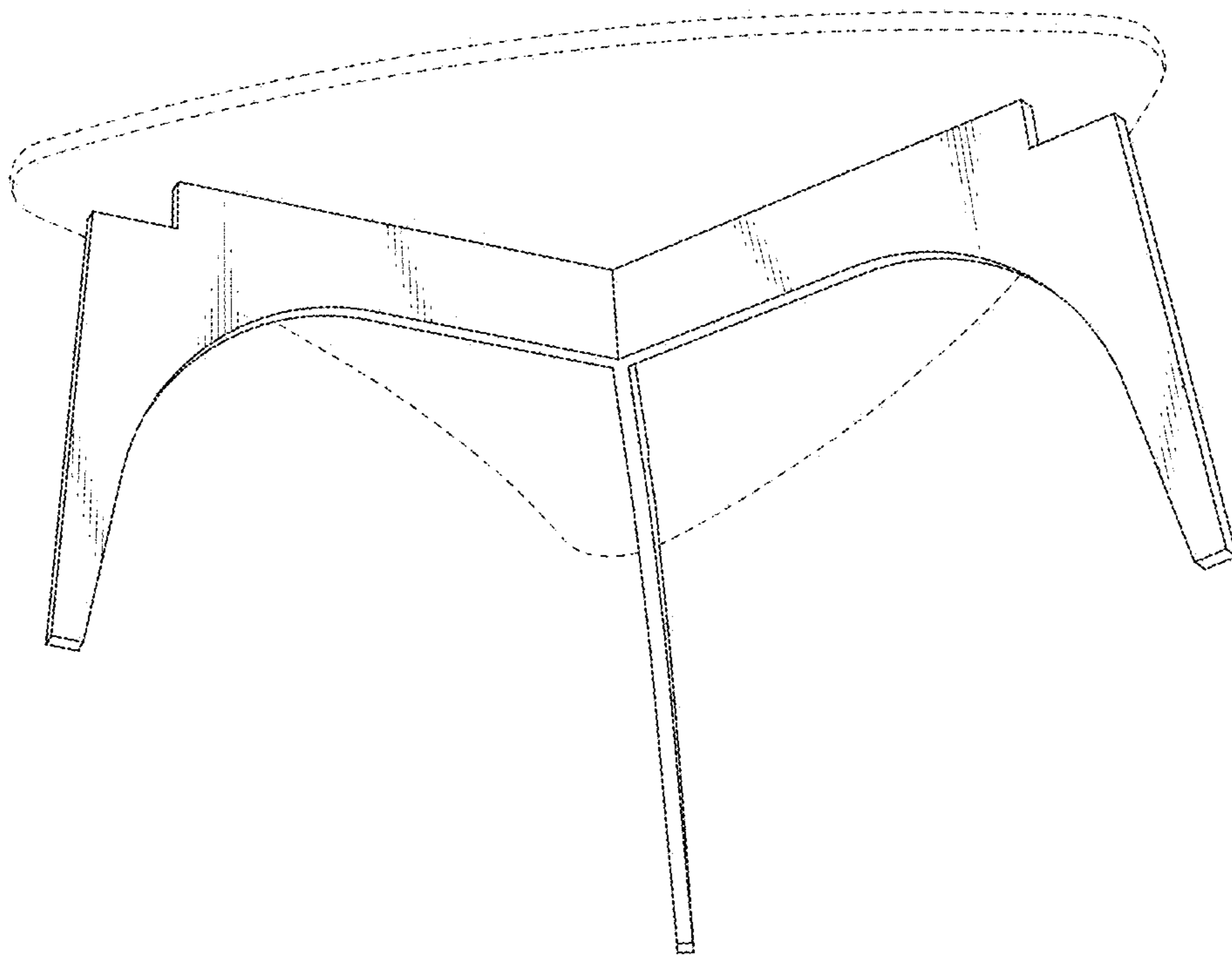

FIG. 4

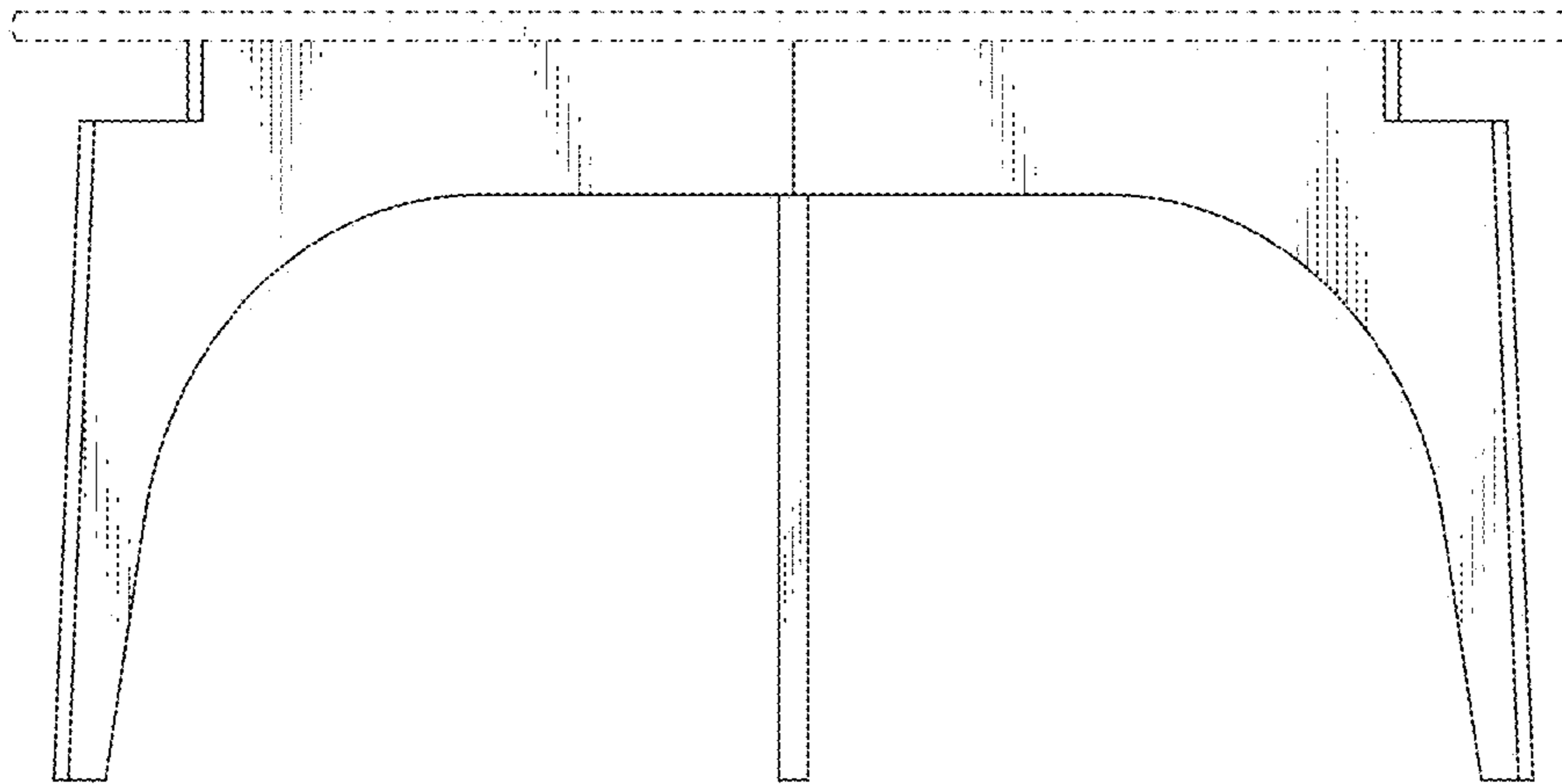

FIG. 5

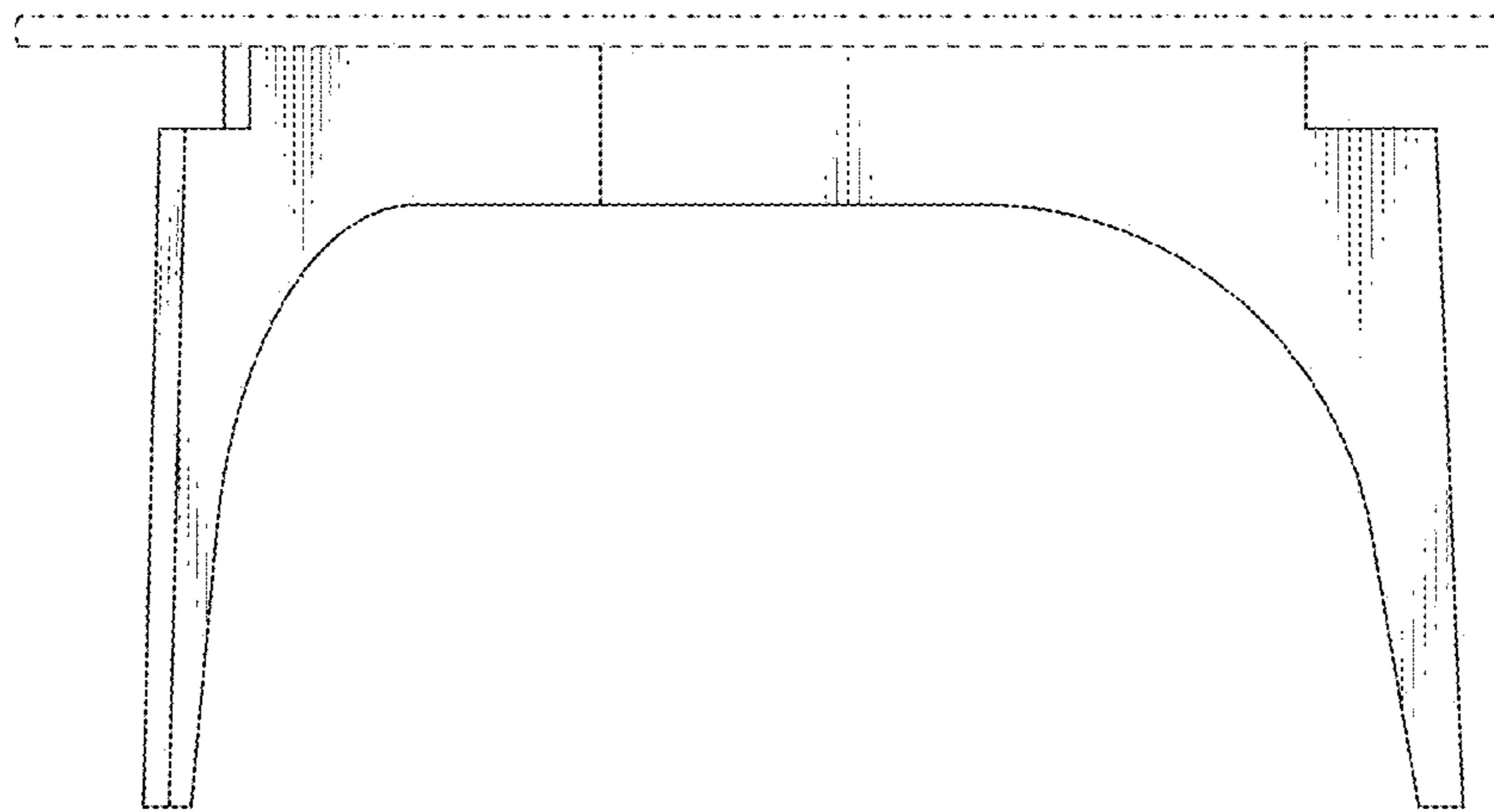

FIG. 6

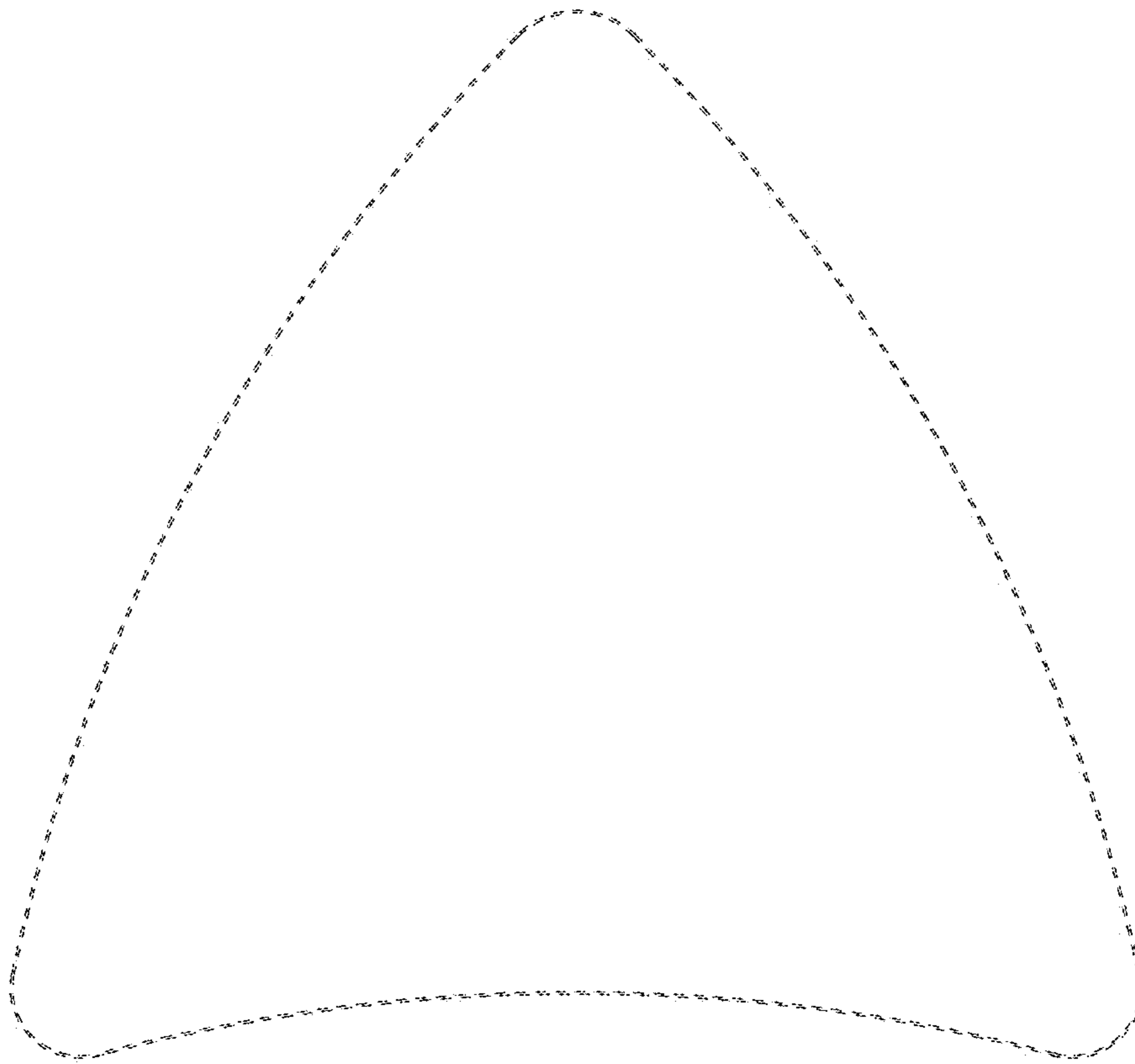

FIG. 7

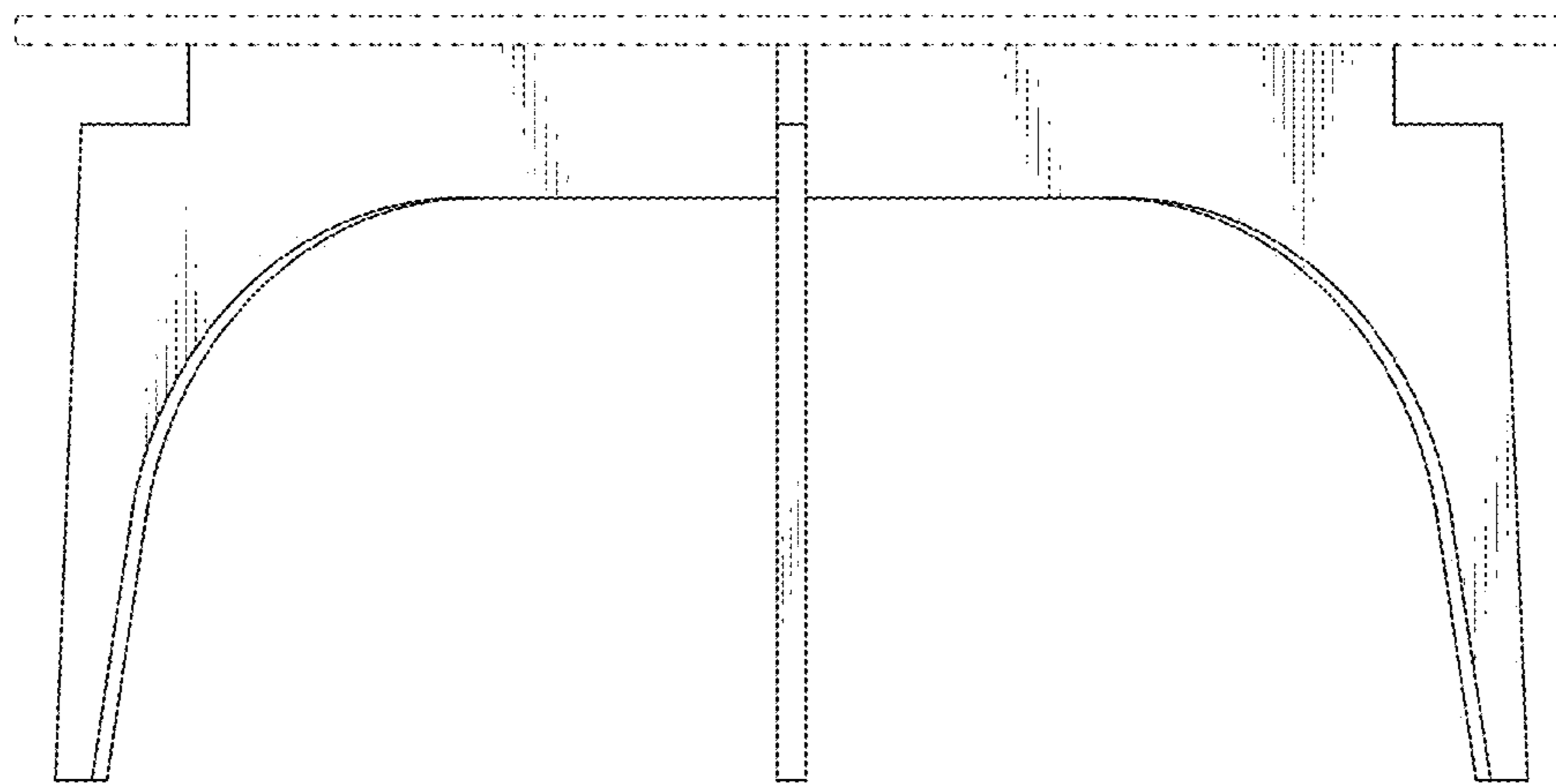



FIG. 8

