

US00D681356S

(12) **United States Design Patent**
Iwasaki

(10) **Patent No.:** **US D681,356 S**

(45) **Date of Patent:** **** May 7, 2013**

(54) **POUF**

D532,618 S * 11/2006 Mourgue D6/352
D545,071 S * 6/2007 Potter D6/336
D587,912 S * 3/2009 Moss D6/349

(75) Inventor: **Ichiro Iwasaki**, Tokyo (JP)

(73) Assignee: **Arper S.p.A.**, Monastier di Treviso,
Treviso (IT)

(**) Term: **14 Years**

(21) Appl. No.: **29/390,061**

(22) Filed: **Apr. 19, 2011**

(30) **Foreign Application Priority Data**

Oct. 20, 2010 (WO) 569740101

(51) **LOC (9) Cl.** **06-01**

(52) **U.S. Cl.**
USPC **D6/349**

(58) **Field of Classification Search** D6/335,
D6/340, 349-355, 495, 500-502; 297/16.1,
297/175, 187, 195.1, 423.1, 423.11, 423.14,
297/423.16, 461, 462

See application file for complete search history.

(56) **References Cited**

U.S. PATENT DOCUMENTS

D172,633 S * 7/1954 Niemann D6/349
D384,211 S * 9/1997 Wied et al. D6/351
D430,412 S * 9/2000 Lewis D6/334

OTHER PUBLICATIONS

Lind Round Ottomans. [online] Retrieved online Jan. 11, 2013 from
URL: <https://svpply.com/item/840127/AERO_BAR_STOOL_Chairs_Stools>.*

Fabric Pouf—soft round ottoman Pix by Arper. [online] Retrieved
online Jan. 11, 2013. Posted Jul. 7, 2011 from URL: <<http://www.trendir.com/archives/005463.html>>.*

* cited by examiner

Primary Examiner — Robert M Spear

Assistant Examiner — Vy Koenig

(74) *Attorney, Agent, or Firm* — Shoemaker and Mattare

(57) **CLAIM**

The ornamental design for a pouf, as shown and described.

DESCRIPTION

FIG. 1 is a perspective view of a pouf, showing our new
design from the front and right side;

FIG. 2 is a right side elevational view thereof;

FIG. 3 is a left side elevational view thereof;

FIG. 4 is a front elevational view thereof;

FIG. 5 is a rear elevational view thereof;

FIG. 6 is a top plan view thereof; and,

FIG. 7 is a bottom plan view thereof.

1 Claim, 7 Drawing Sheets

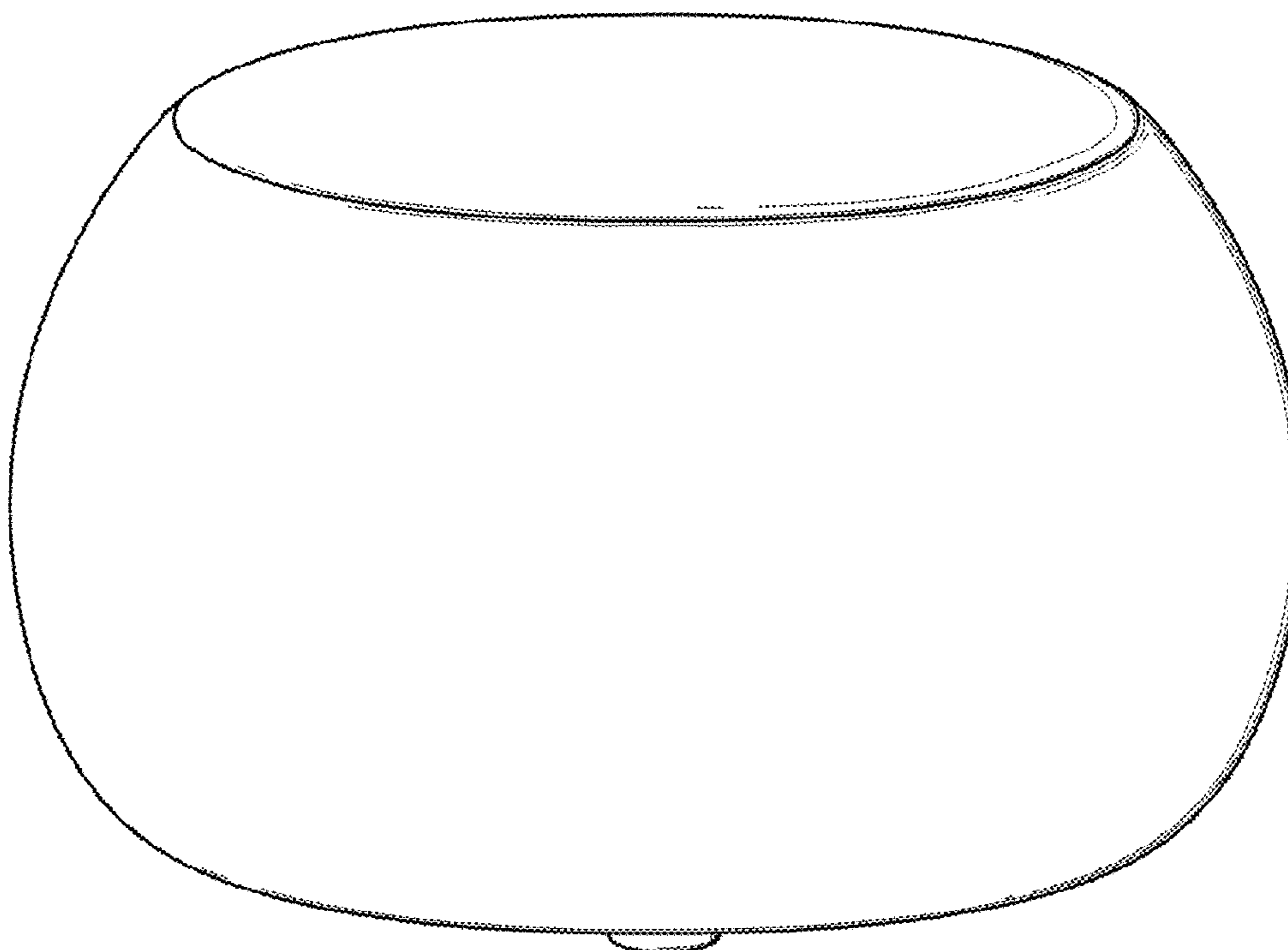

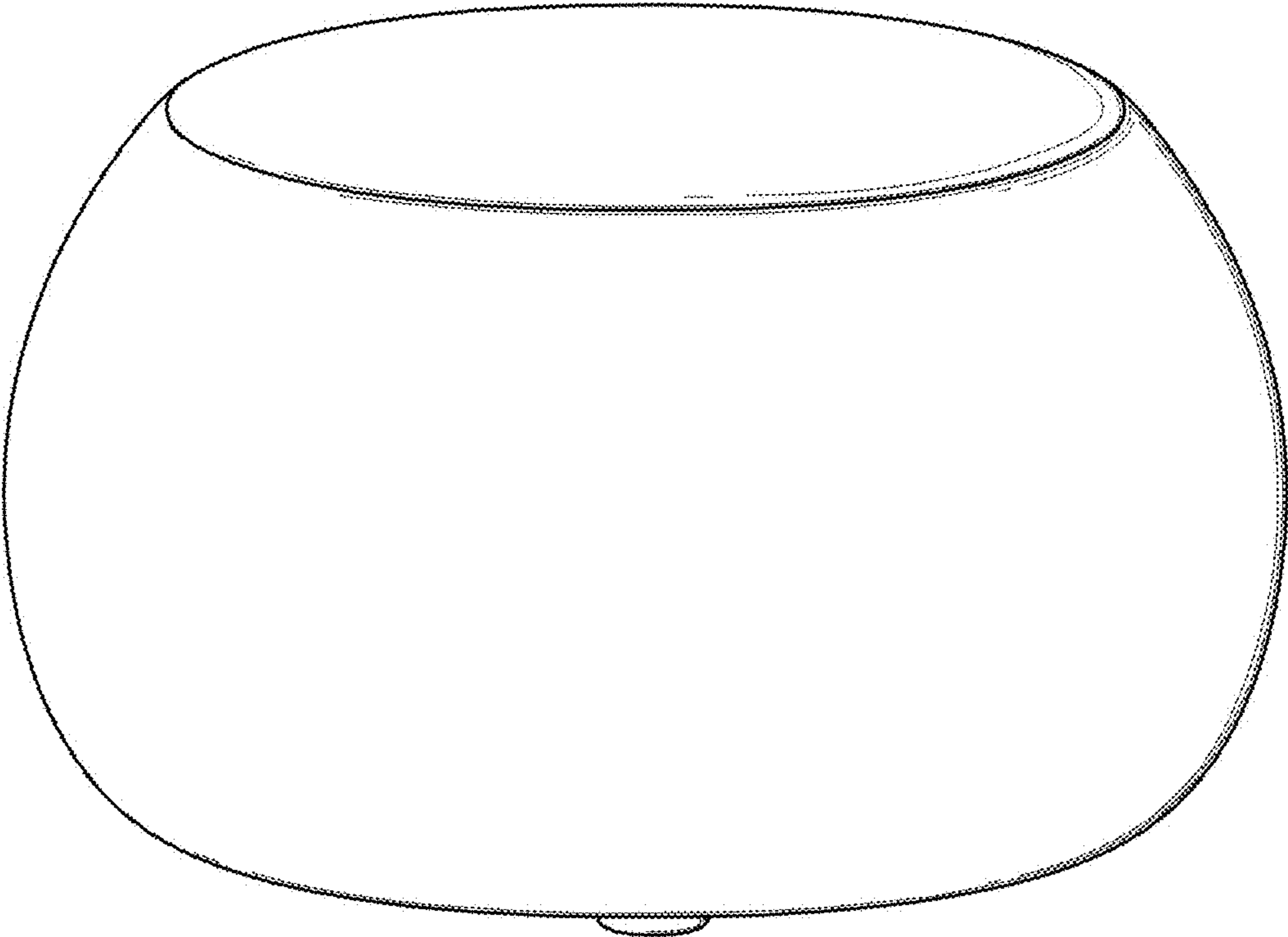

Fig. 1

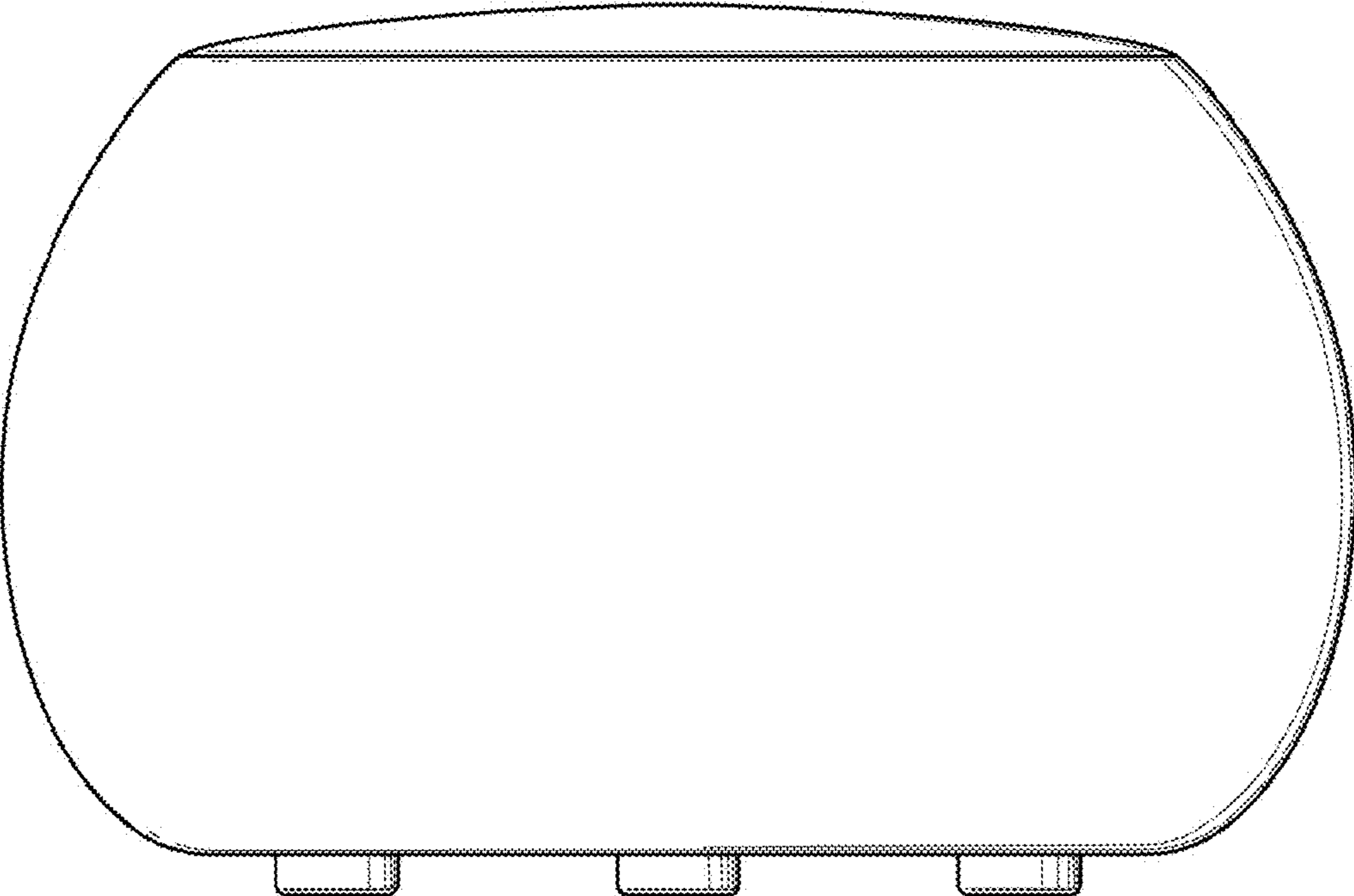

Fig. 2

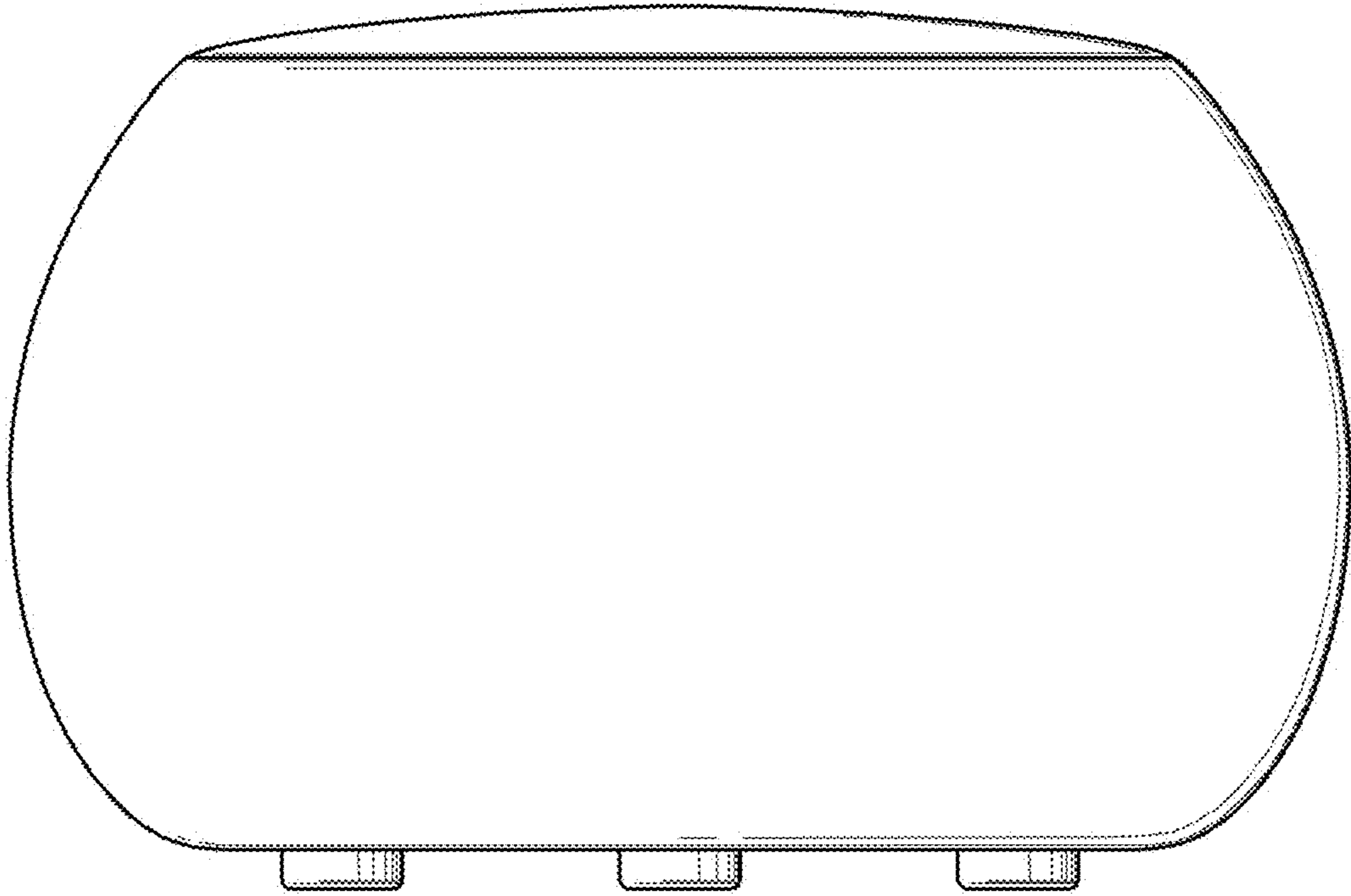

Fig. 3

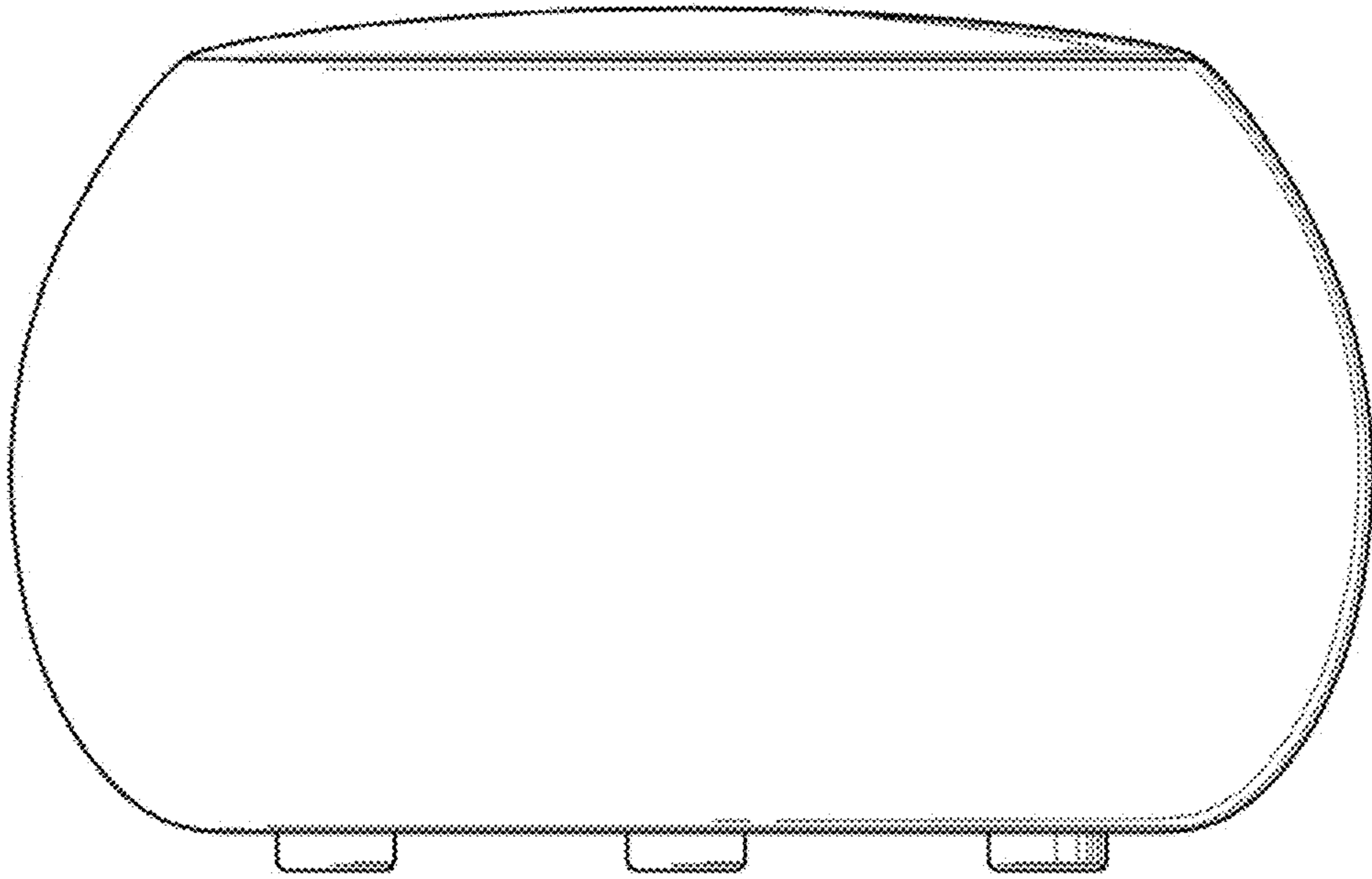

Fig. 4

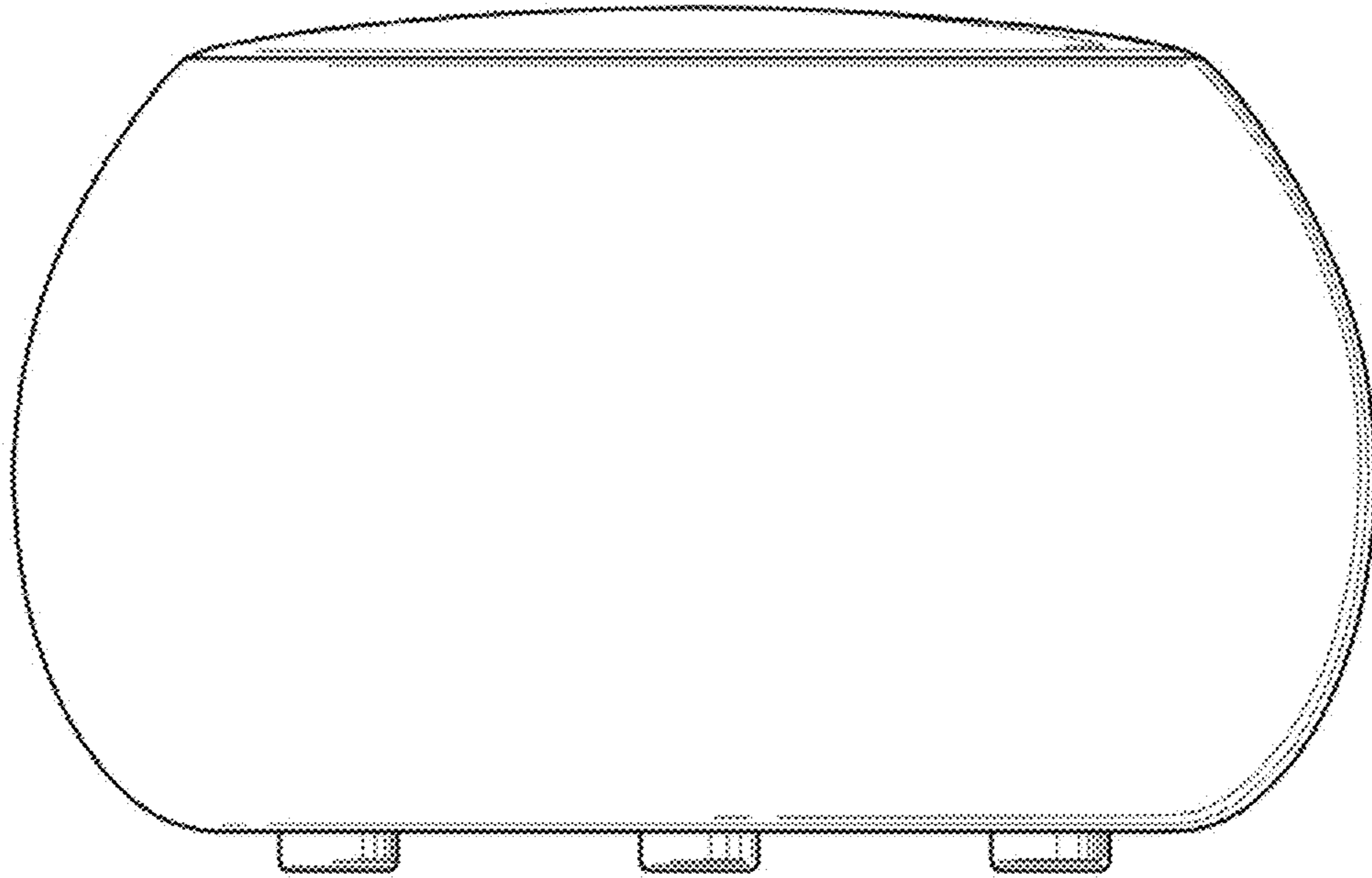

Fig. 5

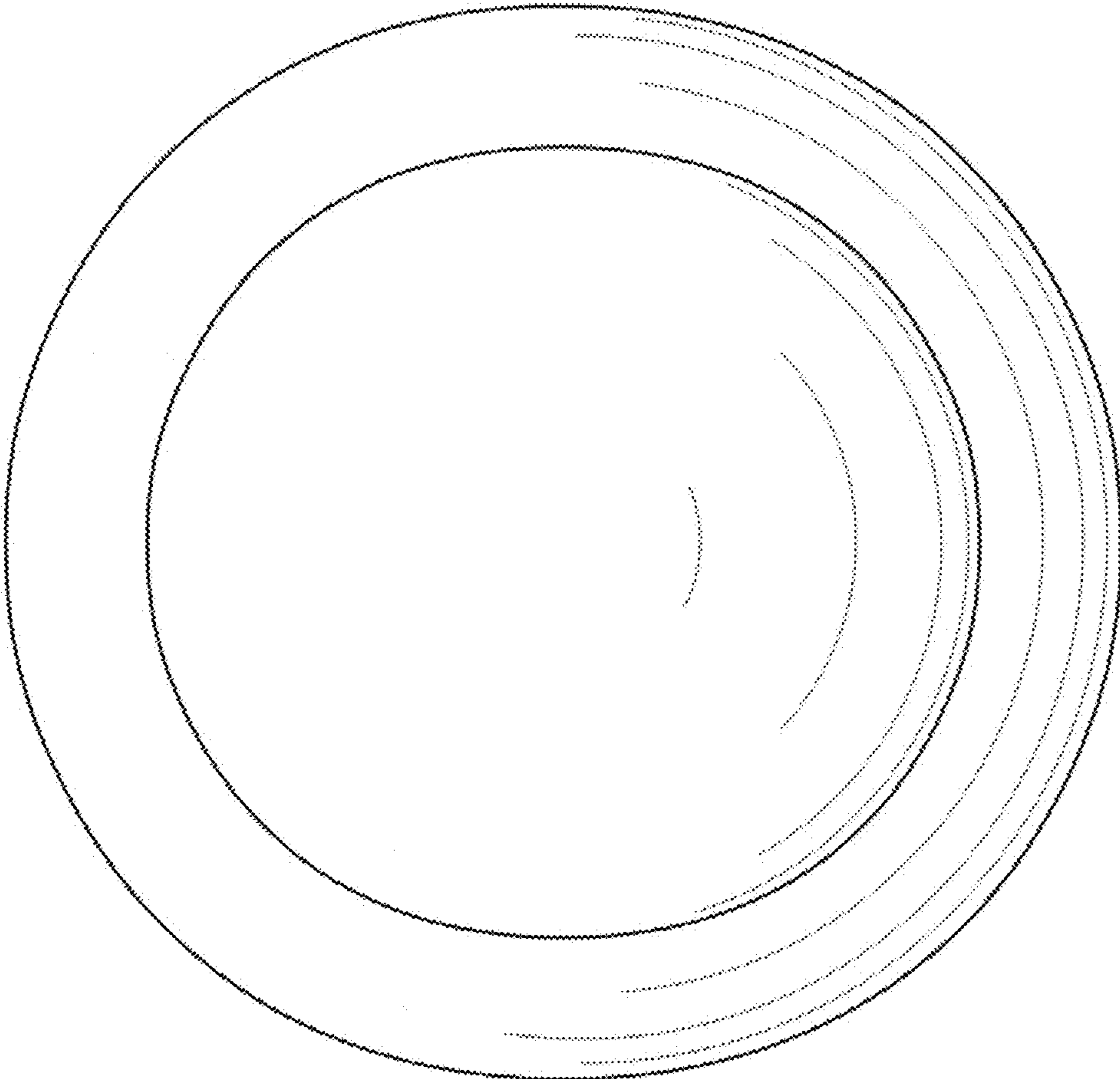

Fig. 6

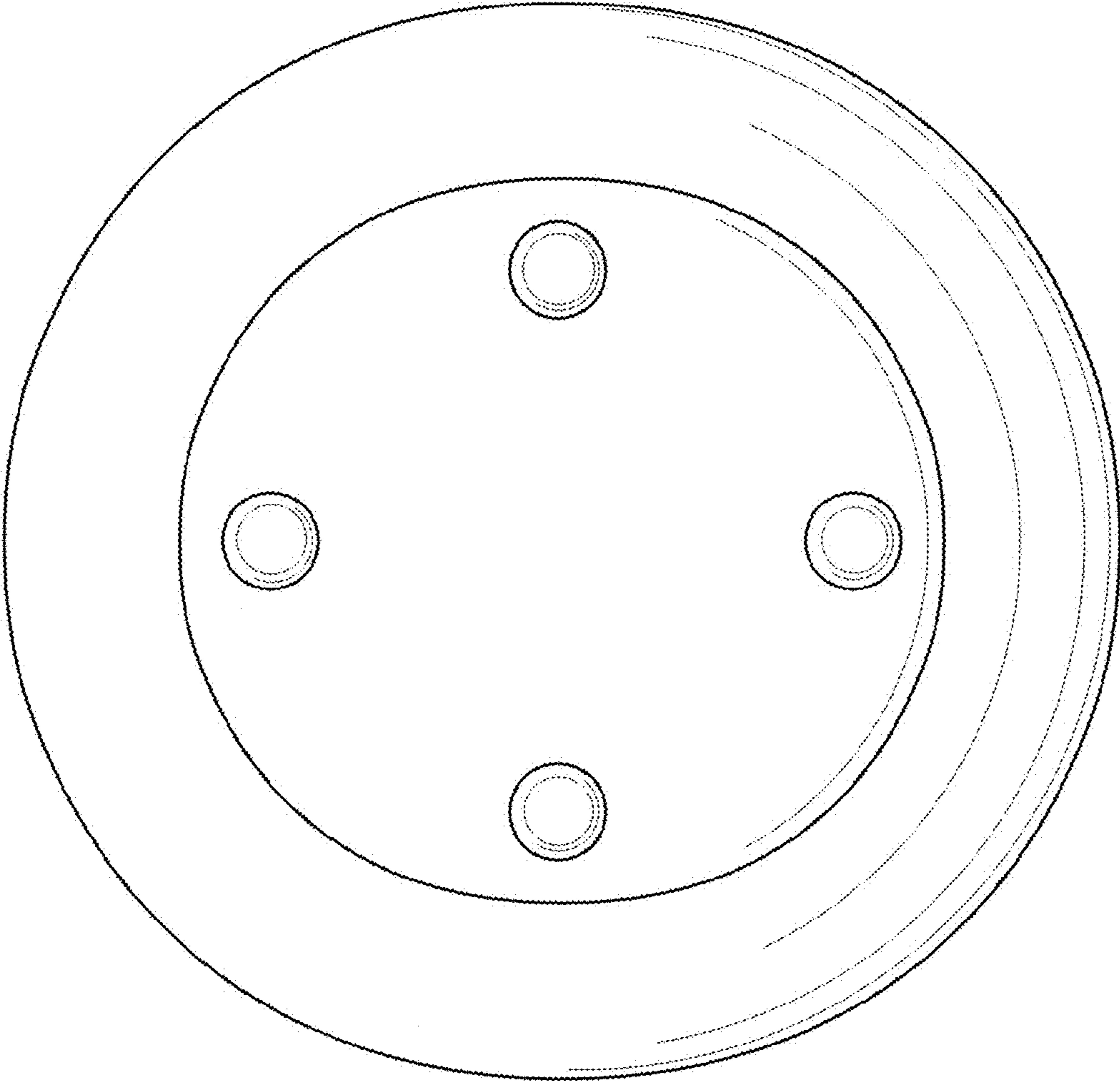

Fig. 7