



US00D681213S

(12) **United States Design Patent**  
**Solby et al.**

(10) **Patent No.:** **US D681,213 S**  
(45) **Date of Patent:** **\*\* Apr. 30, 2013**

- (54) **TRANSMITTER FOR HEARING AID**
- (75) Inventors: **Martin Solby**, Lyngø (DK); **Torben Arnt**, Lyngø (DK)
- (73) Assignee: **Widex A/S**, Lyngø (DK)
- (\*\*) Term: **14 Years**
- (21) Appl. No.: **29/416,849**
- (22) Filed: **Mar. 27, 2012**
- (51) **LOC (9) Cl.** ..... **24-99**
- (52) **U.S. Cl.**  
USPC ..... **D24/174**
- (58) **Field of Classification Search** ..... D24/173-175,  
D24/151; D14/205, 206, 223-226, 249,  
D14/155; 381/23.1, 312, 322-324, 328,  
381/330, 380, 381; 181/135  
See application file for complete search history.

- D595,262 S \* 6/2009 Nousiainen ..... D14/206
- D605,168 S \* 12/2009 Jaakkola et al. .... D14/205
- D605,293 S \* 12/2009 Kurokawa et al. .... D24/174
- D616,875 S \* 6/2010 Oh et al. .... D14/240
- D625,418 S \* 10/2010 Borregaard ..... D24/174
- D627,069 S \* 11/2010 Mehlsen et al. .... D24/174

\* cited by examiner

*Primary Examiner* — Anhdao Doan

(74) *Attorney, Agent, or Firm* — Sughrue Mion, PLLC

(57) **CLAIM**

The ornamental design for a transmitter for hearing aid, as shown and described.

**DESCRIPTION**

FIG. 1 is a perspective view of a transmitter for a hearing aid, showing our new design;  
 FIG. 2 is a right side view thereof;  
 FIG. 3 is a rear view thereof;  
 FIG. 4 is a left side view thereof;  
 FIG. 5 is a bottom view thereof;  
 FIG. 6 is a front view thereof; and,  
 FIG. 7 is a top view thereof.  
 Parts shown in the above figures in broken lines form no part of the claimed design.

**1 Claim, 4 Drawing Sheets**

(56) **References Cited**

**U.S. PATENT DOCUMENTS**

- 4,066,849 A \* 1/1978 Chladil, Sr. .... 381/371
- D340,522 S \* 10/1993 Silbersky ..... D24/174
- D502,698 S \* 3/2005 Mah ..... D14/226
- D552,603 S \* 10/2007 Tierney ..... D14/226
- D594,443 S \* 6/2009 Lee et al. .... D14/223

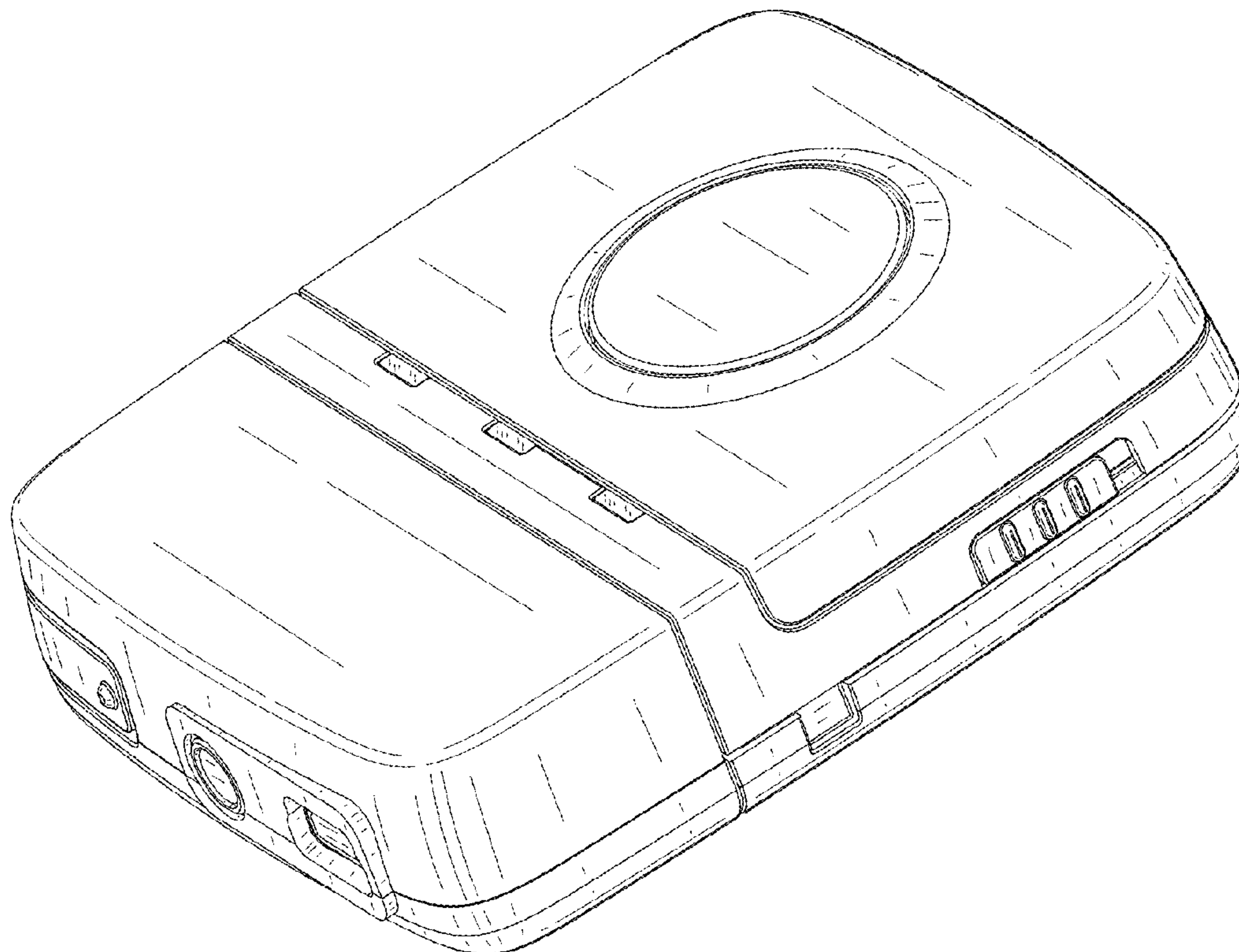

FIG. 1

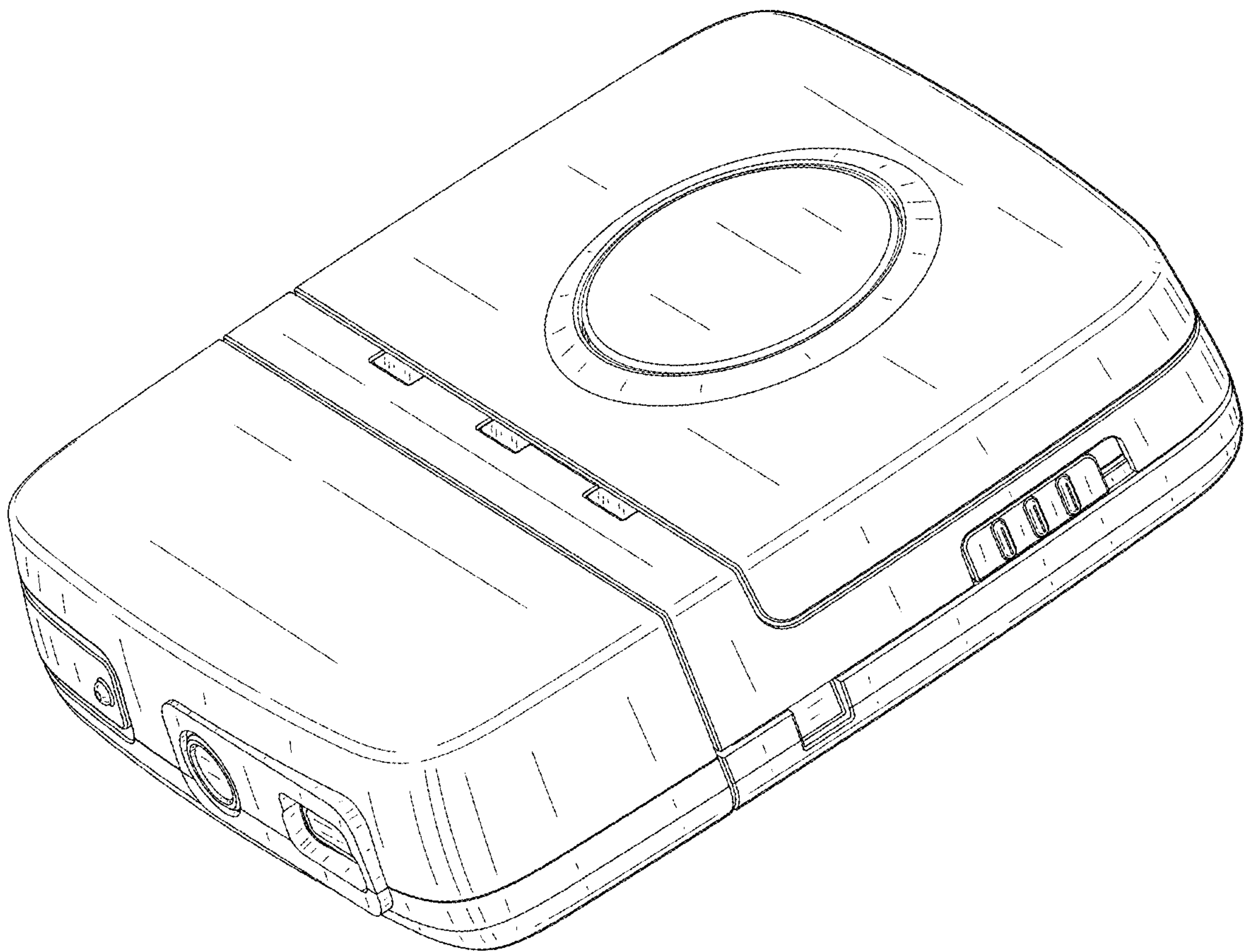

FIG. 2

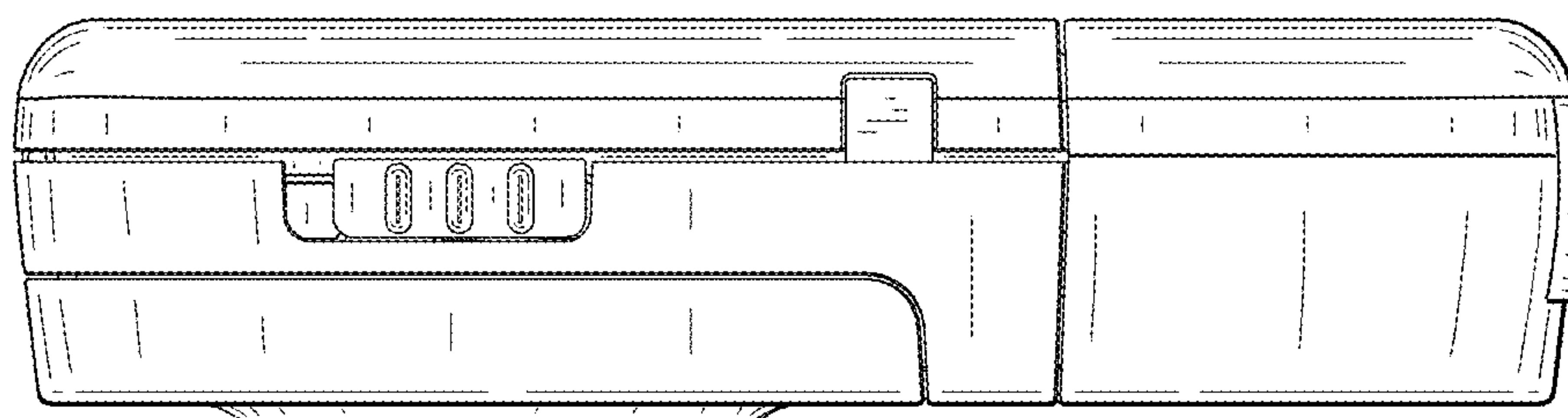

FIG. 3

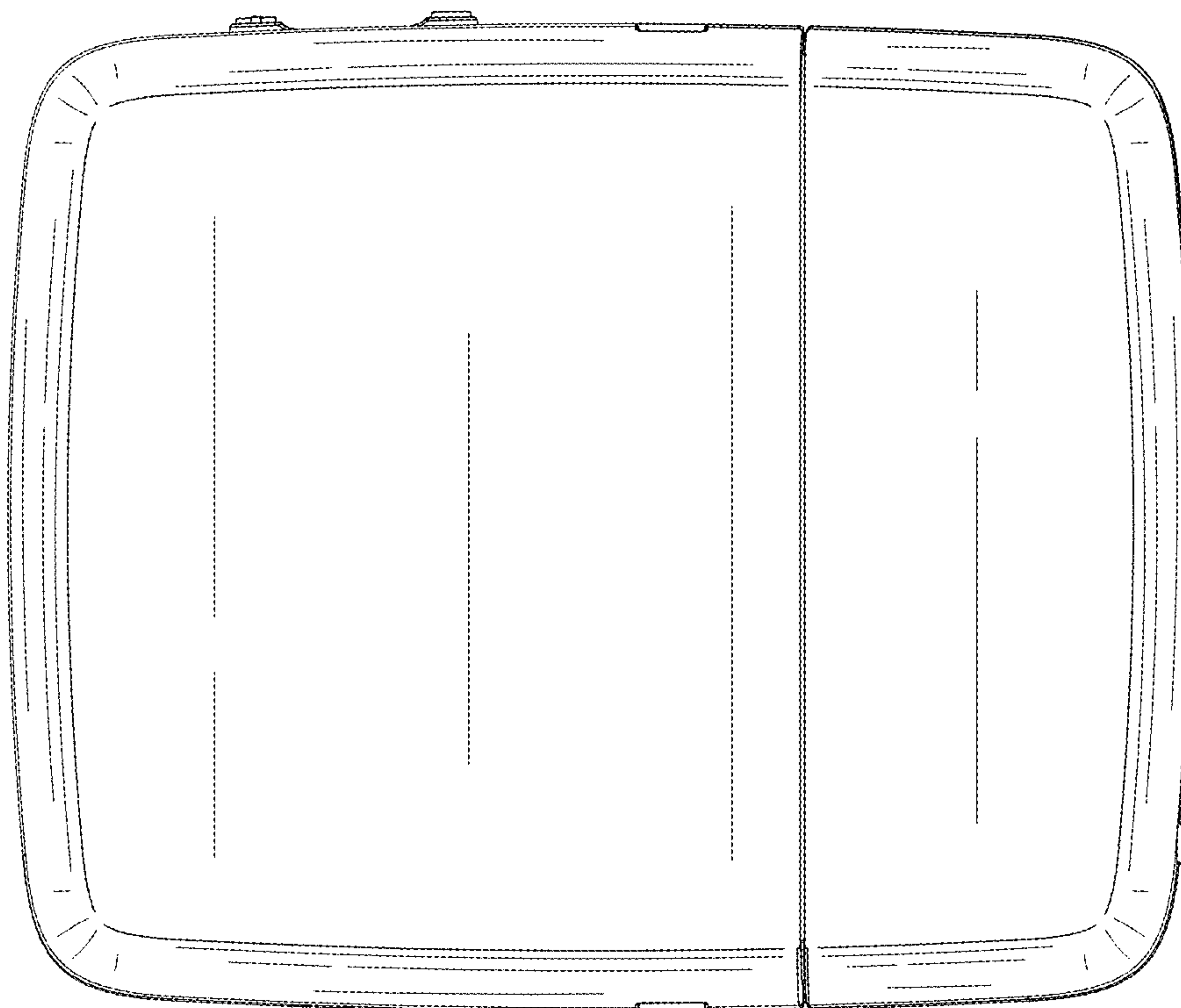

FIG. 4

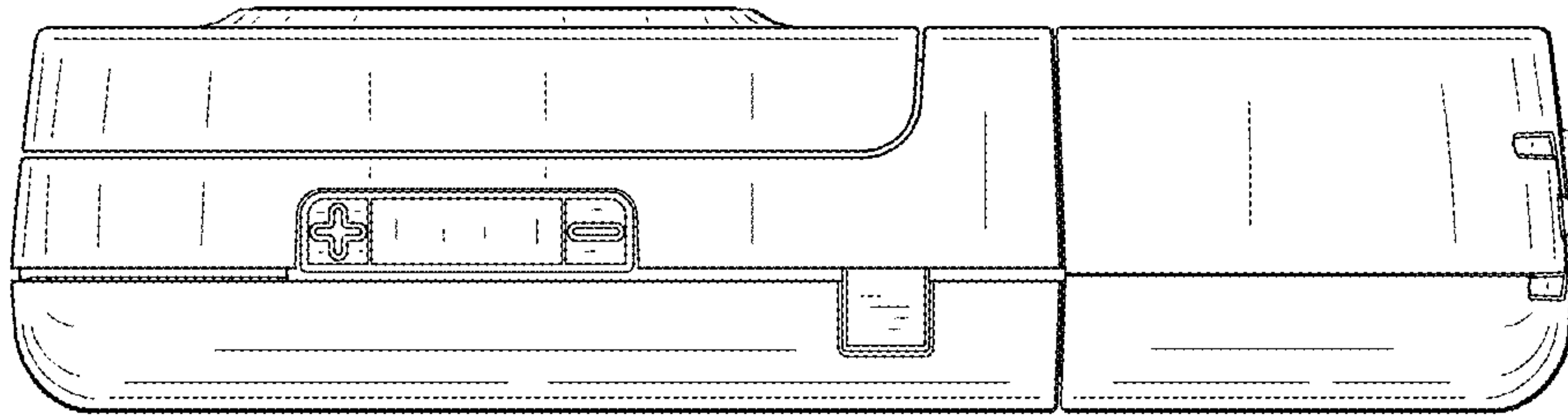

FIG. 5

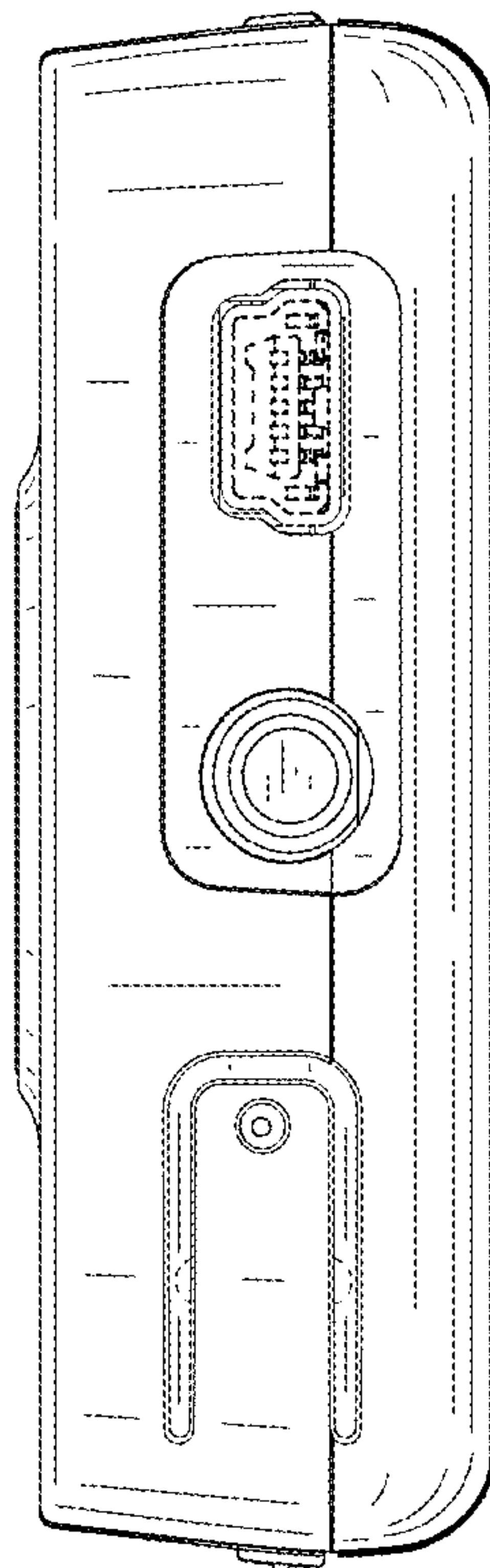



FIG. 6

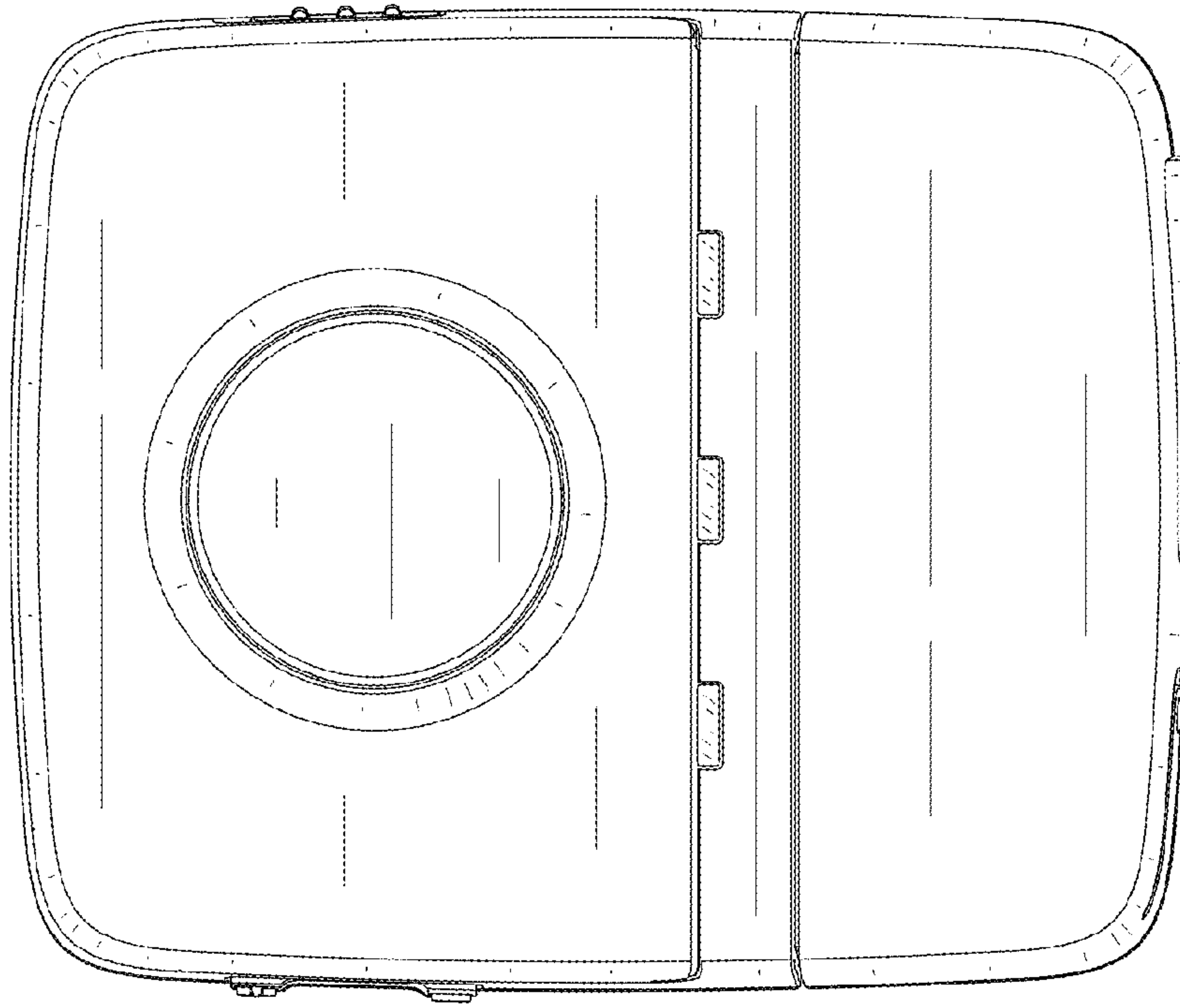

FIG. 7

