



US00D681180S

(12) **United States Design Patent**
Chouji

(10) **Patent No.:** **US D681,180 S**

(45) **Date of Patent:** **** Apr. 30, 2013**

(54) **AIR-CONDITIONER**

(75) Inventor: **Masahiko Chouji**, Kusatsu (JP)

(73) Assignee: **Daikin Industries Ltd.**, Osaka-Shi (JP)

(**) Term: **14 Years**

(21) Appl. No.: **29/371,912**

(22) Filed: **Jan. 19, 2012**

(30) **Foreign Application Priority Data**

Aug. 11, 2011 (JP) 2011-018421

(51) **LOC (9) Cl.** **23-04**

(52) **U.S. Cl.**
USPC **D23/351**

(58) **Field of Classification Search** D23/351-354,
D23/385, 355, 357, 361; 312/236; 62/259.1,
62/259.4, 262-263, 304; 454/330-331, 349-350
See application file for complete search history.

(56) **References Cited**

U.S. PATENT DOCUMENTS

D529,158 S *	9/2006	Ueno et al.	D23/351
D564,081 S *	3/2008	Yamamoto	D23/351
D579,095 S *	10/2008	Nagahori et al.	D23/351
D580,534 S *	11/2008	Oh et al.	D23/351
D581,504 S *	11/2008	Nakamura et al.	D23/351
D584,806 S *	1/2009	Oh et al.	D23/351
D605,266 S *	12/2009	Nakamura et al.	D23/351
D605,267 S *	12/2009	Nakamura et al.	D23/351
D613,384 S *	4/2010	Ohta	D23/351
D621,018 S *	8/2010	Nagahori et al.	D23/351
D624,168 S *	9/2010	Aketa et al.	D23/351

D632,769 S *	2/2011	Seki	D23/351
D641,847 S *	7/2011	Seki	D23/351
D642,249 S *	7/2011	Seki	D23/351
D642,250 S *	7/2011	Chouji	D23/351
D648,015 S *	11/2011	Baek et al.	D23/351
D657,035 S *	4/2012	Chouji	D23/351
D667,095 S *	9/2012	Yamana et al.	D23/351
D669,567 S *	10/2012	Yamana et al.	D23/351
D674,068 S *	1/2013	Baek et al.	D23/351

* cited by examiner

Primary Examiner — Brian N Vinson

(74) *Attorney, Agent, or Firm* — Manabu Kanesaka

(57) **CLAIM**

The ornamental design for an air-conditioner, as shown and described.

DESCRIPTION

FIG. 1 is a perspective view of an air-conditioner showing my new design;

FIG. 2 is a front view thereof;

FIG. 3 is a rear view thereof;

FIG. 4 is a plan view thereof;

FIG. 5 is a bottom view thereof;

FIG. 6 is a left side view thereof;

FIG. 7 is a right side view thereof; and,

FIG. 8 is a cross-sectional view thereof taken along line 8-8 of FIG. 2.

The broken lines depict portions of the air-conditioner that form no part of claimed design.

1 Claim, 7 Drawing Sheets

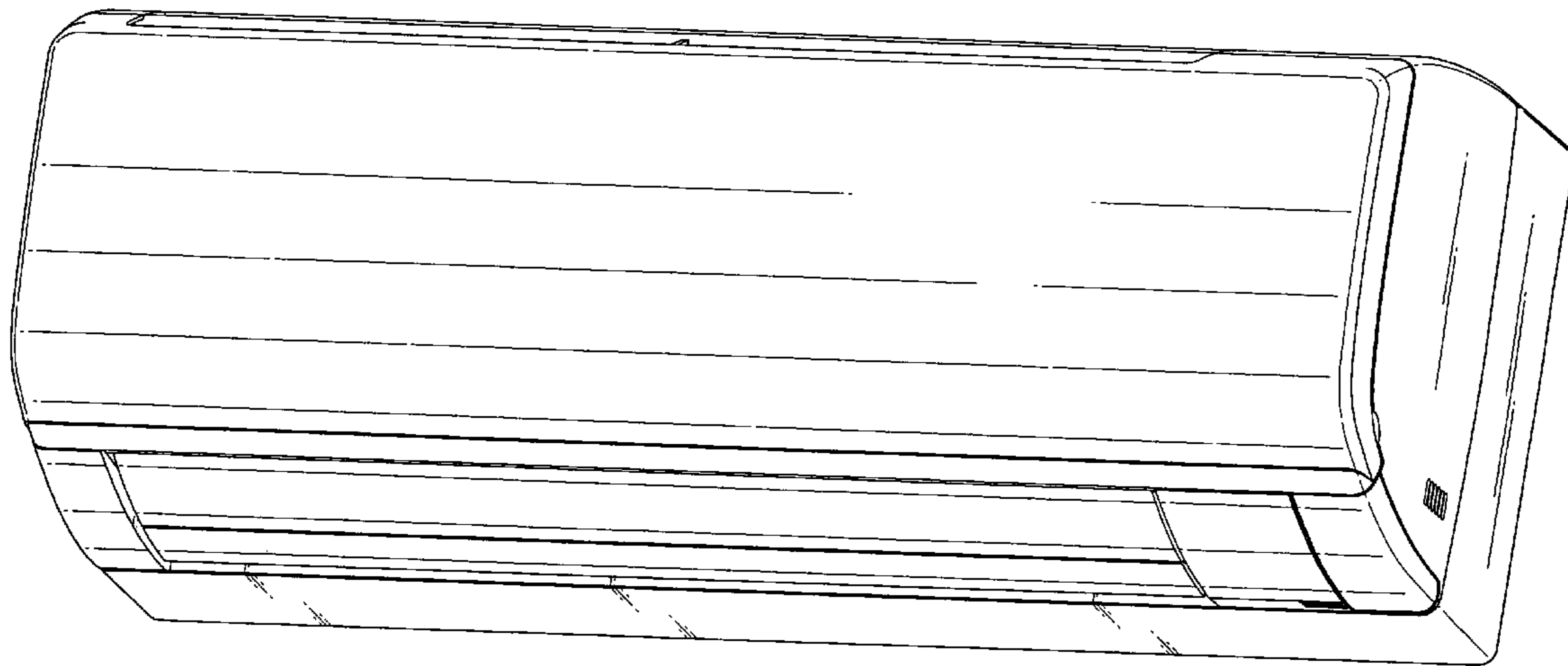

Fig. 1

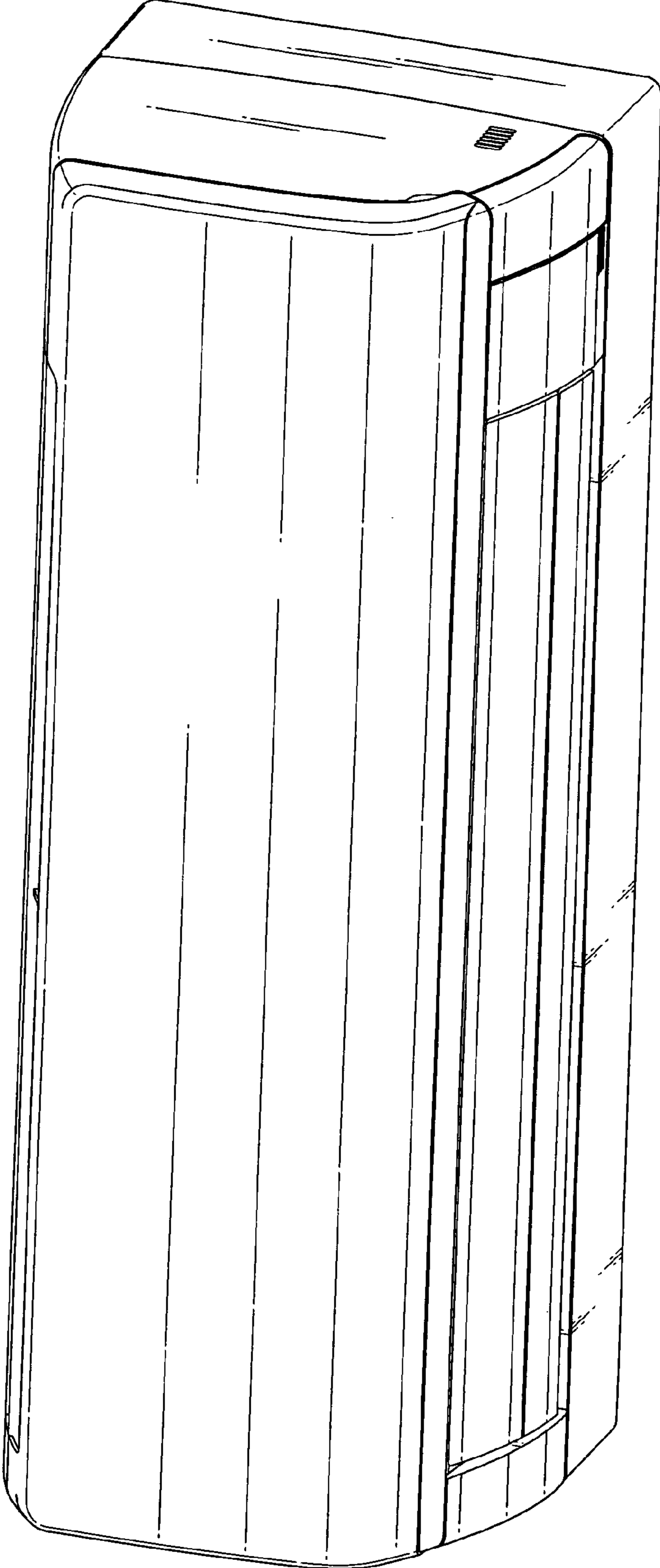

Fig. 2

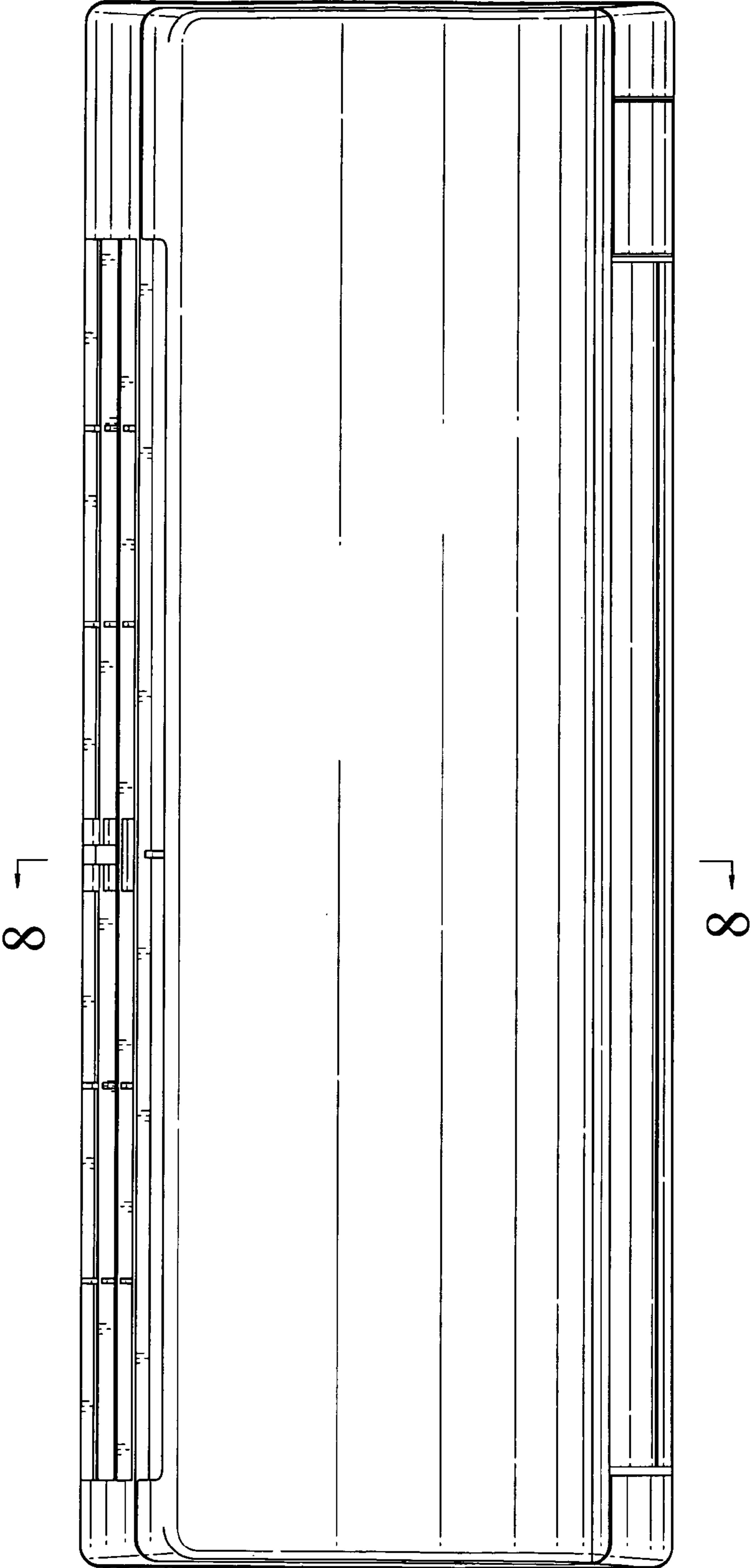

Fig. 3



Fig. 4

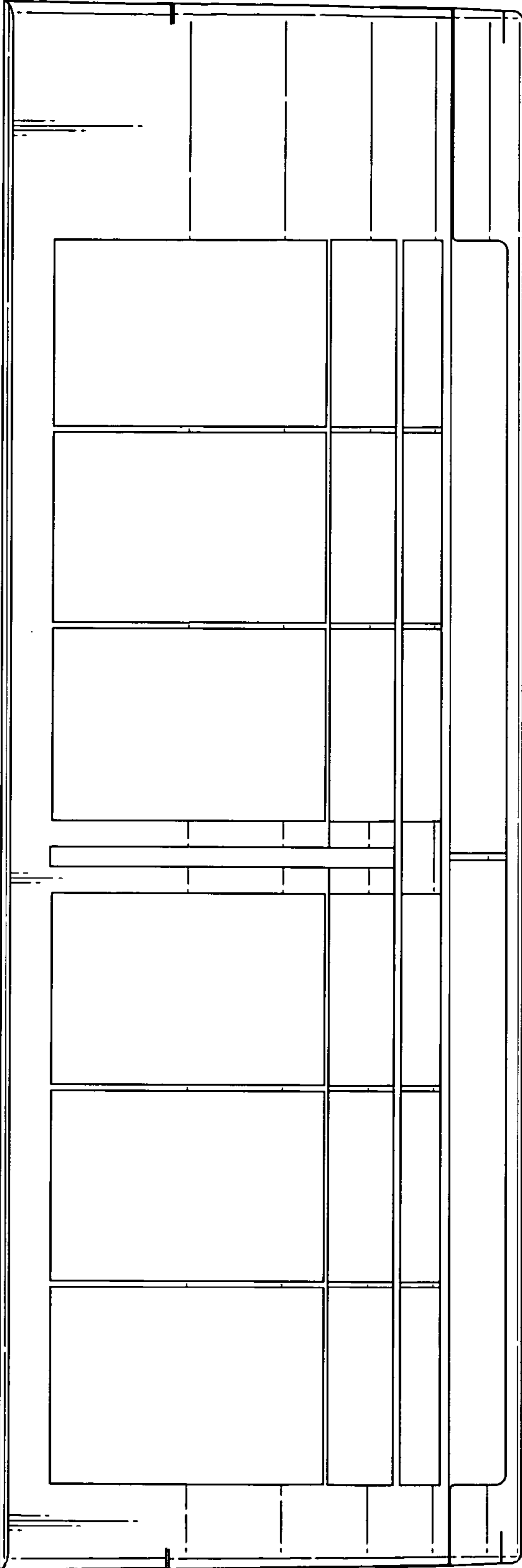

Fig. 5

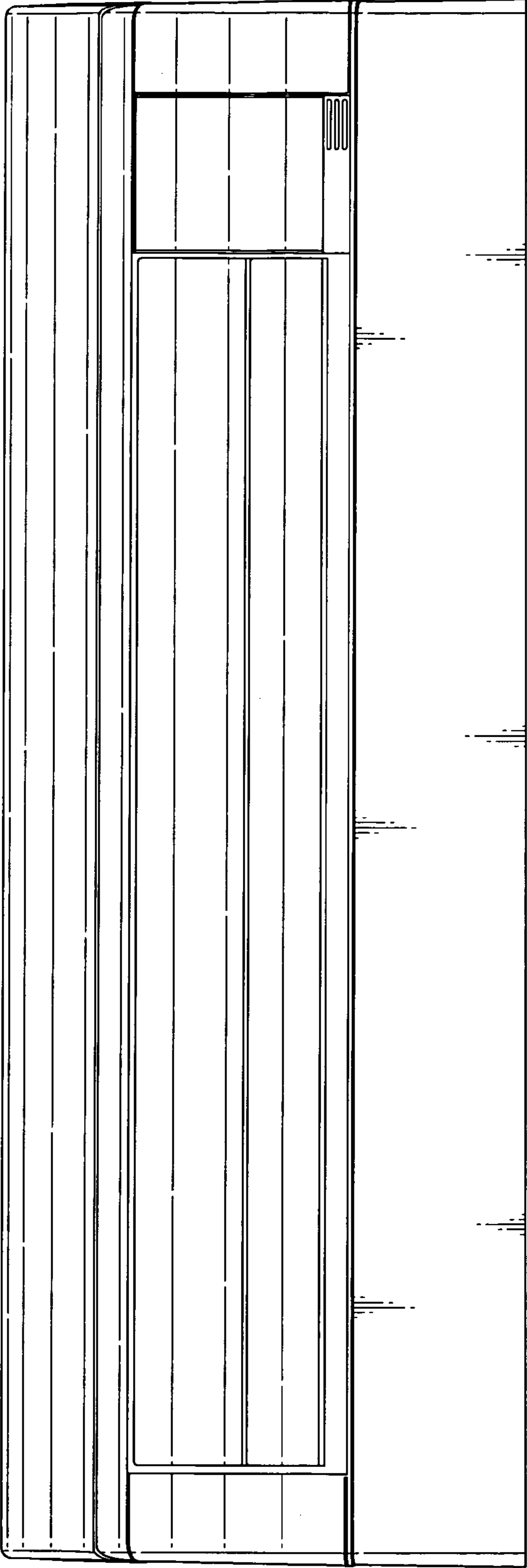

Fig. 7

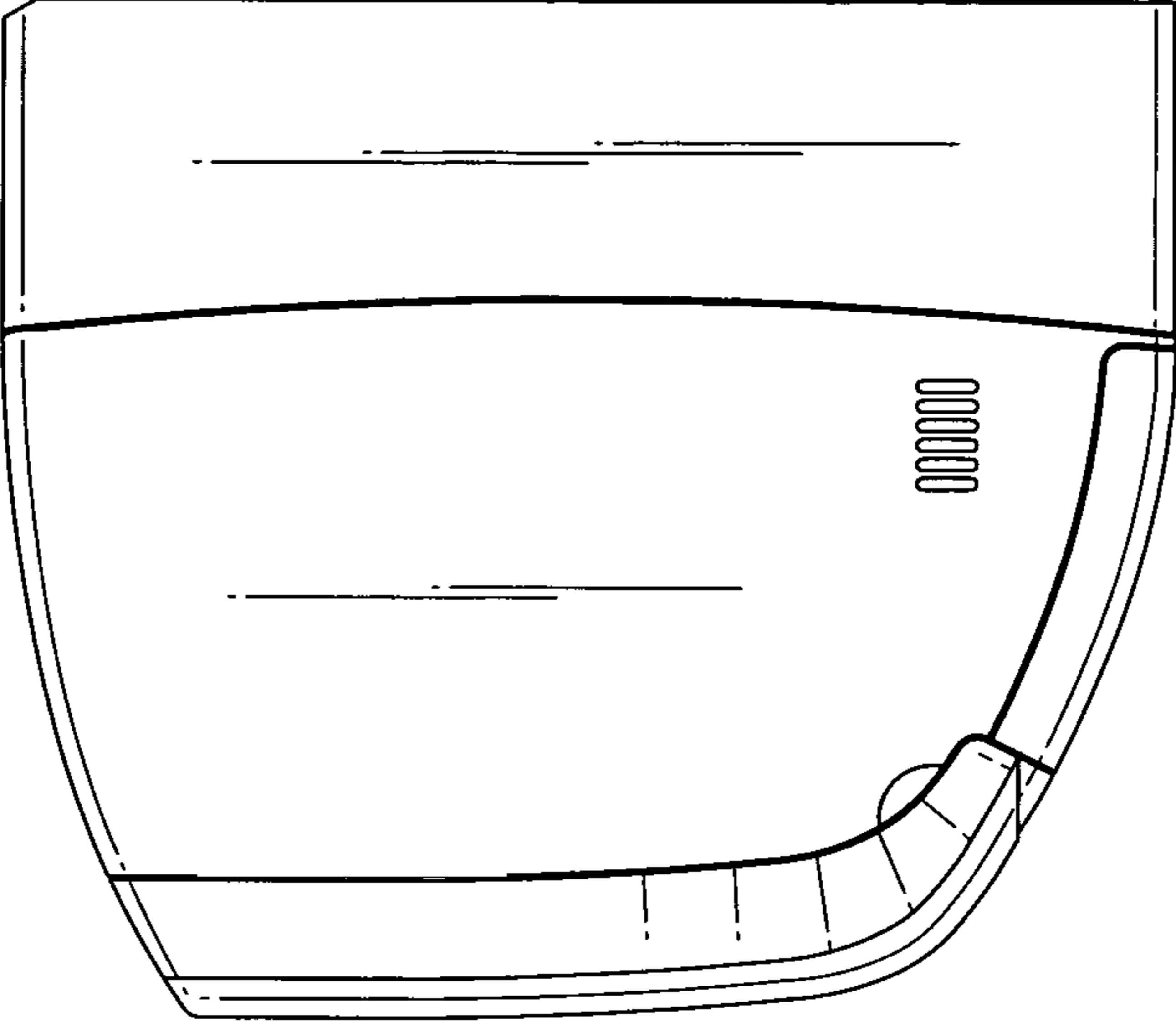

Fig. 6

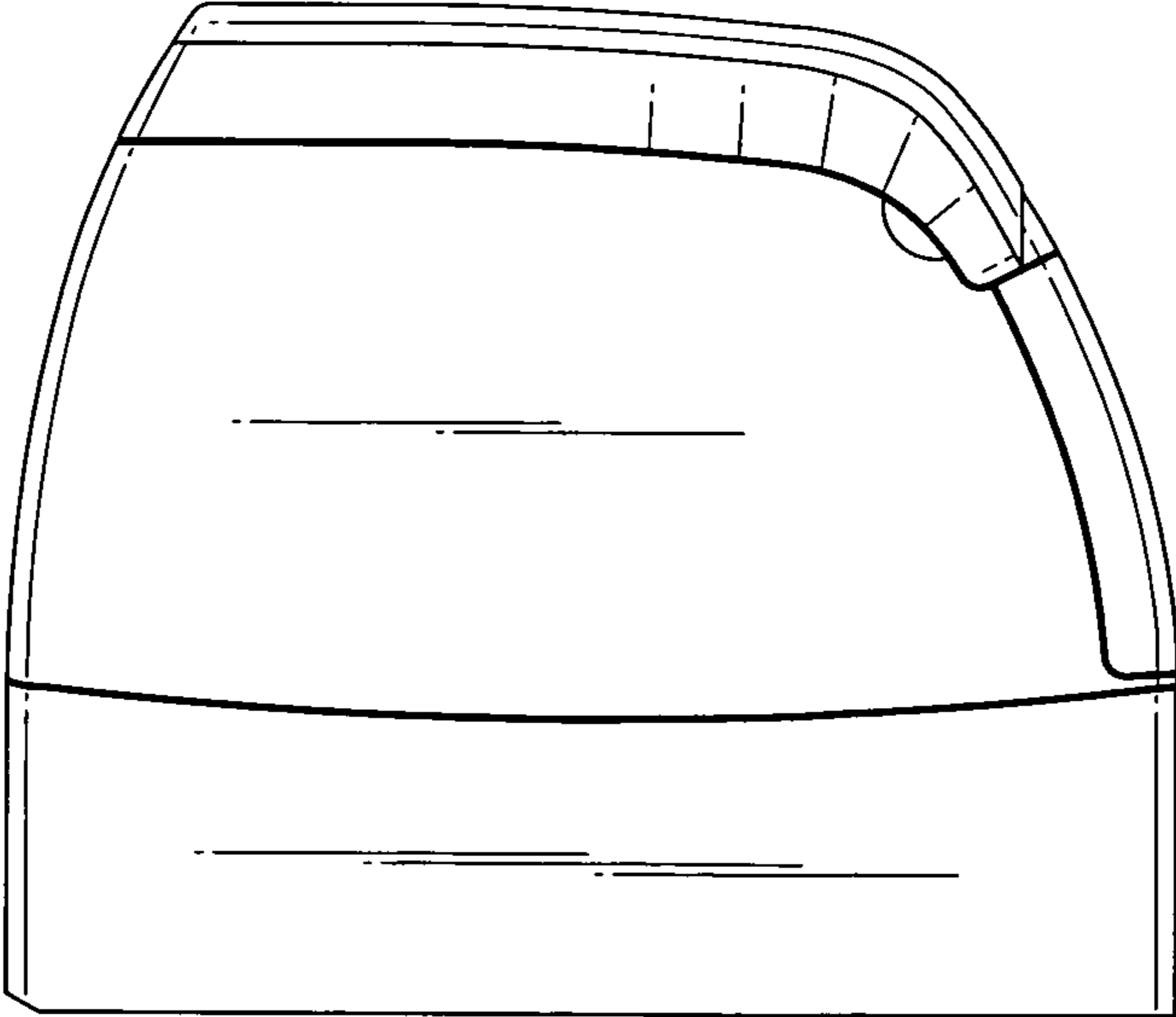

Fig. 8

