



US00D681084S

(12) **United States Design Patent**  
**Snyder et al.**

(10) **Patent No.:** **US D681,084 S**  
(45) **Date of Patent:** **\*\* \*Apr. 30, 2013**

(54) **EQUIPMENT SUPPORT PAD**

(75) Inventors: **Darryl L. Snyder**, Canton, OH (US);  
**Bryan Dougherty**, Dellroy, OH (US);  
**Paul E. Dougherty**, Dellroy, OH (US)

(73) Assignee: **Snyder National Corporation**, Canton,  
OH (US)

(\*) Notice: This patent is subject to a terminal dis-  
claimer.

(\*\*) Term: **14 Years**

(21) Appl. No.: **29/402,197**

(22) Filed: **Sep. 21, 2011**

(51) **LOC (9) Cl.** ..... **15-09**

(52) **U.S. Cl.**  
USPC ..... **D15/141**

(58) **Field of Classification Search** ..... D25/199;  
D8/354, 374; D15/141, 199; 248/346.01,  
248/346.02, 346.5, 678, 637

See application file for complete search history.

(56) **References Cited**

U.S. PATENT DOCUMENTS

2,544,743	A	3/1951	Vrabcak	
3,790,115	A	2/1974	Fox et al.	
4,050,659	A	9/1977	McCannon et al.	
4,505,449	A	3/1985	Turner et al.	
4,869,456	A	9/1989	Jacobs	
4,946,725	A	8/1990	Harlan	
5,076,534	A	12/1991	Adam	
5,333,830	A	8/1994	Millen	
5,833,207	A *	11/1998	Hagenhoff et al.	..... 248/678
5,895,025	A	4/1999	Alesi et al.	

5,950,980	A	9/1999	Folmar	
5,961,093	A	10/1999	Jones et al.	
6,050,539	A	4/2000	Millen	
6,186,468	B1 *	2/2001	Schlegel	..... 248/678
6,518,499	B1	2/2003	Kessler	
6,892,993	B2 *	5/2005	Palmer	..... 248/346.02
7,300,032	B2	11/2007	Williams et al.	
7,334,421	B1	2/2008	Cantolino	
D575,313	S *	8/2008	Hull et al.	..... D15/141
7,780,140	B1	8/2010	Ward et al.	
D661,980	S *	6/2012	Rocquet	..... D8/374
2003/0183741	A1	10/2003	Milner	
2010/0207004	A1	8/2010	Hermans et al.	

\* cited by examiner

*Primary Examiner* — Doris Clark

(74) *Attorney, Agent, or Firm* — Zollinger & Burleson Ltd.

(57) **CLAIM**

The ornamental design for an equipment support pad, as shown and described.

**DESCRIPTION**

FIG. 1 is a top perspective view of the equipment support pad showing our new design.

FIG. 2 is a bottom perspective view of the equipment support pad showing our new design.

FIG. 3 is a bottom plan view thereof.

FIG. 4 is a top plan view thereof.

FIG. 5 is a front elevation view thereof; the rear elevation view being a mirror image thereof; and,

FIG. 6 is a left side elevation view thereof; the right side elevation being a mirror image.

The features depicted in broken lines form no part of the claimed invention.

**1 Claim, 5 Drawing Sheets**

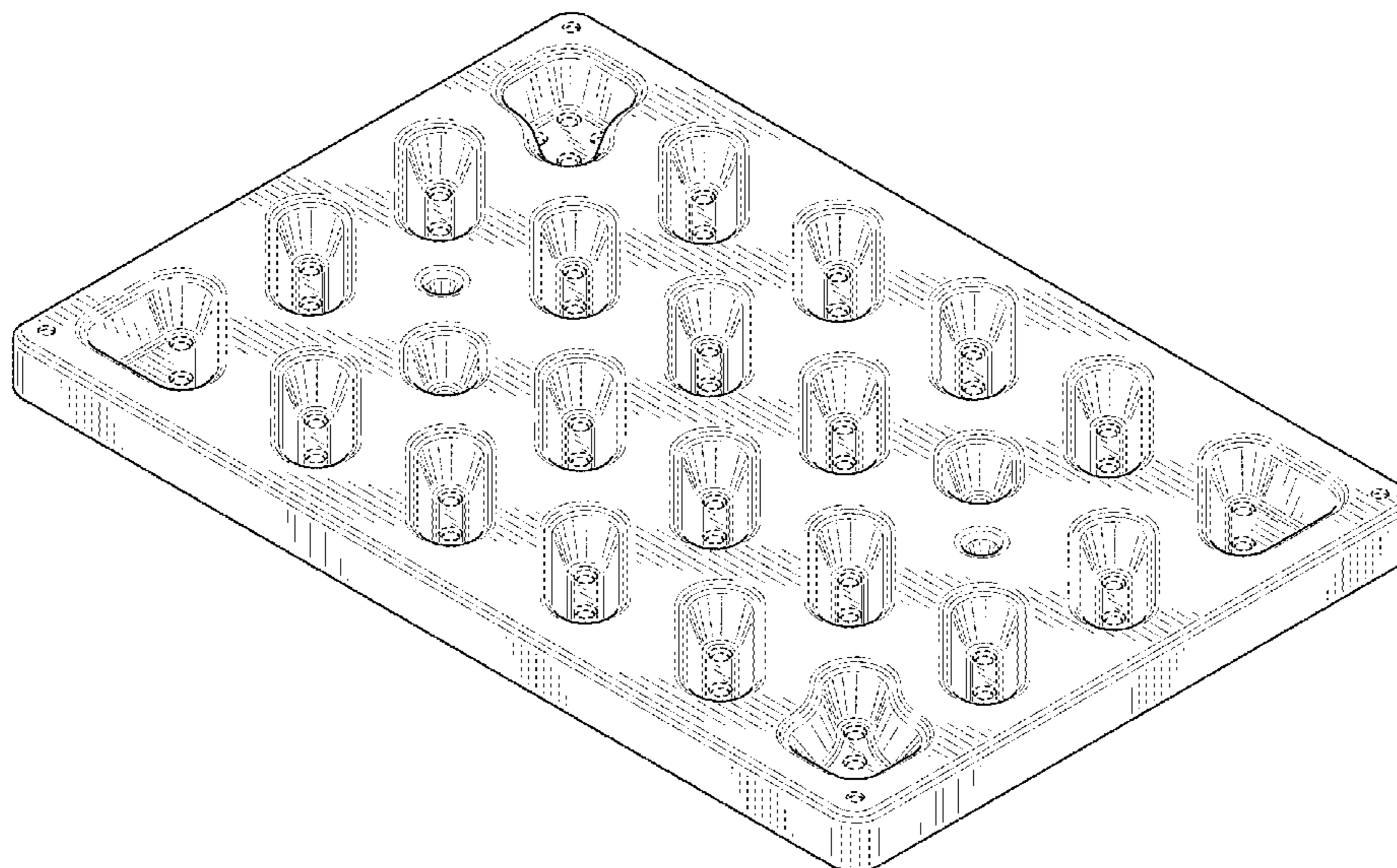

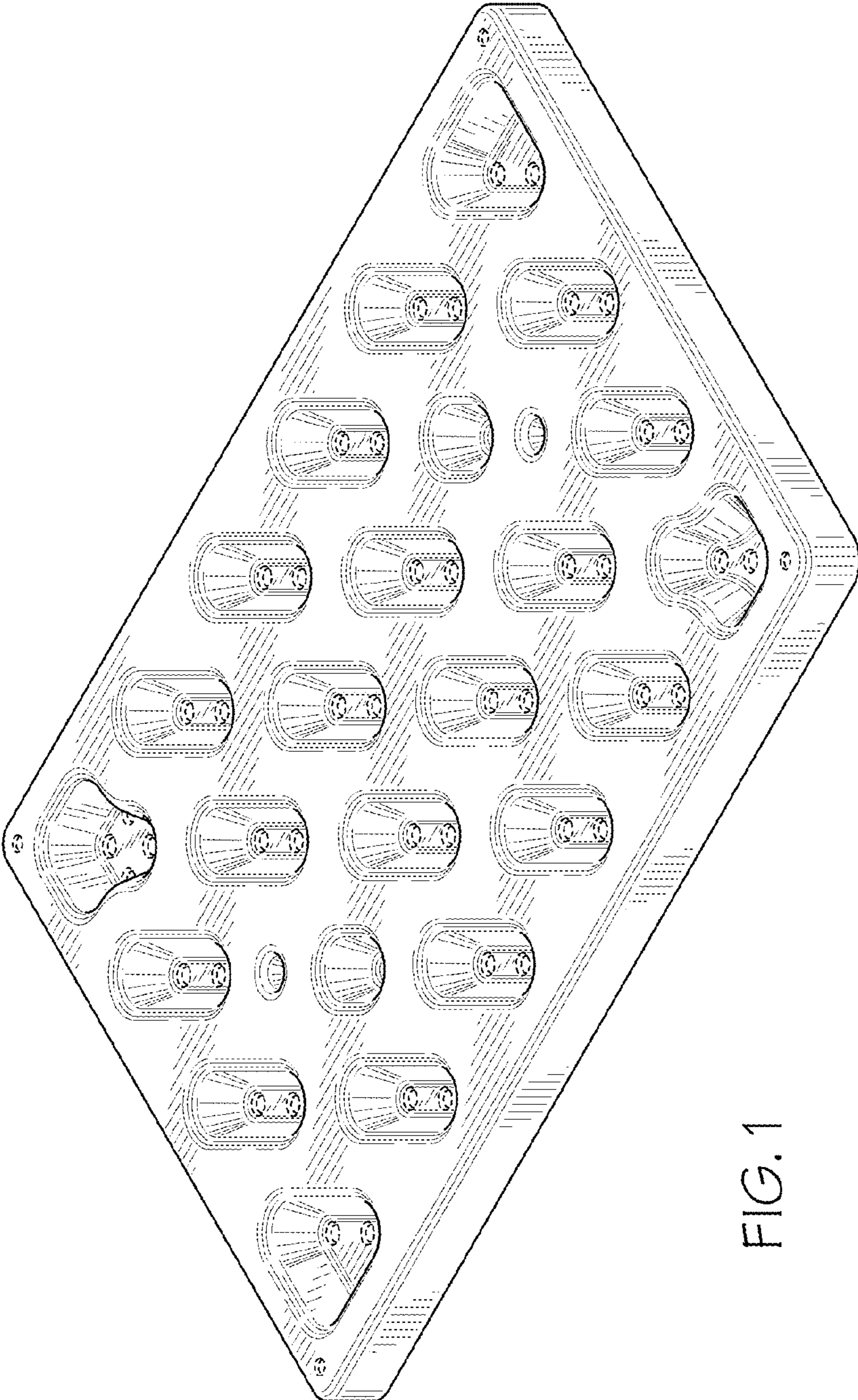

FIG. 1

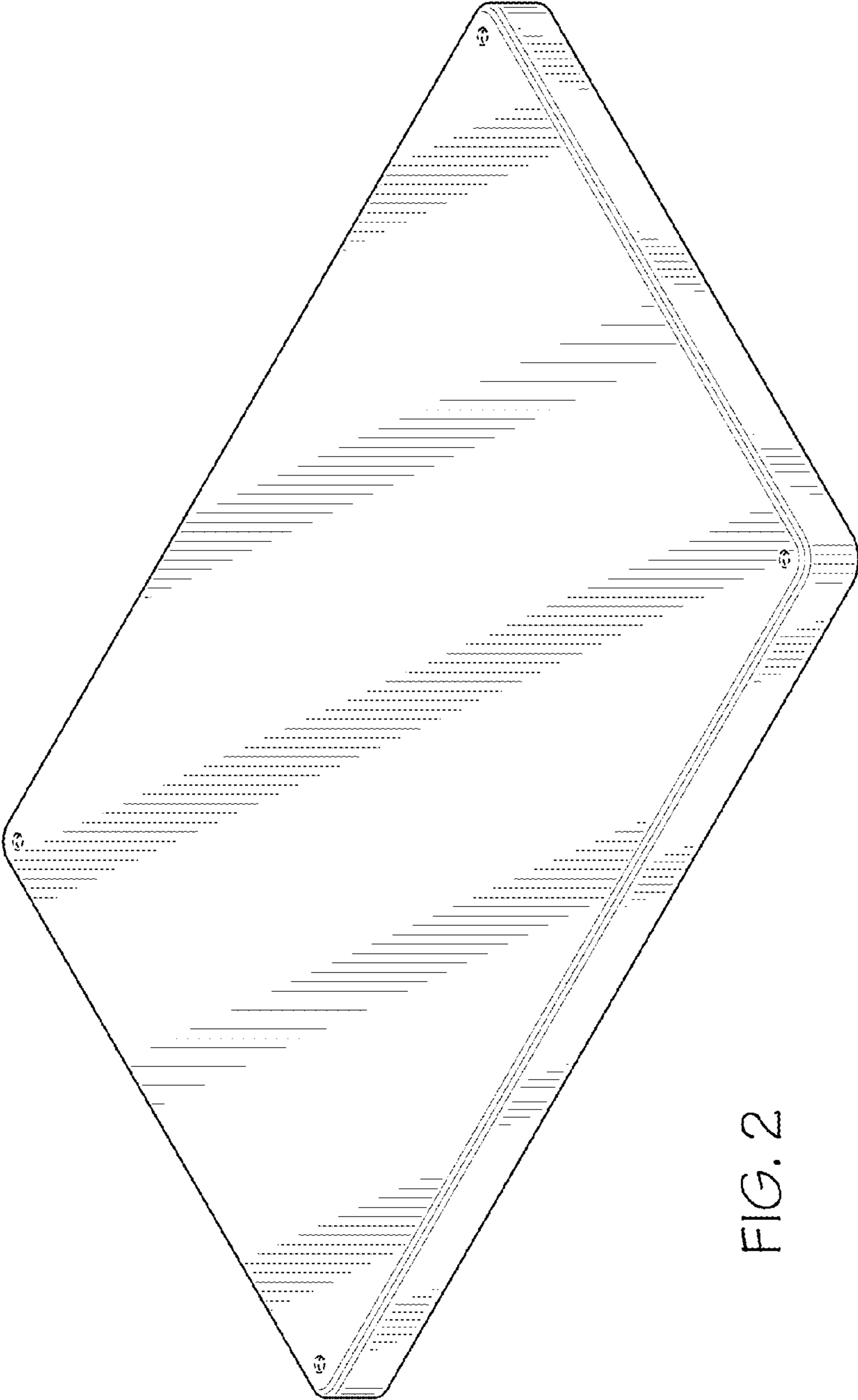

FIG. 2

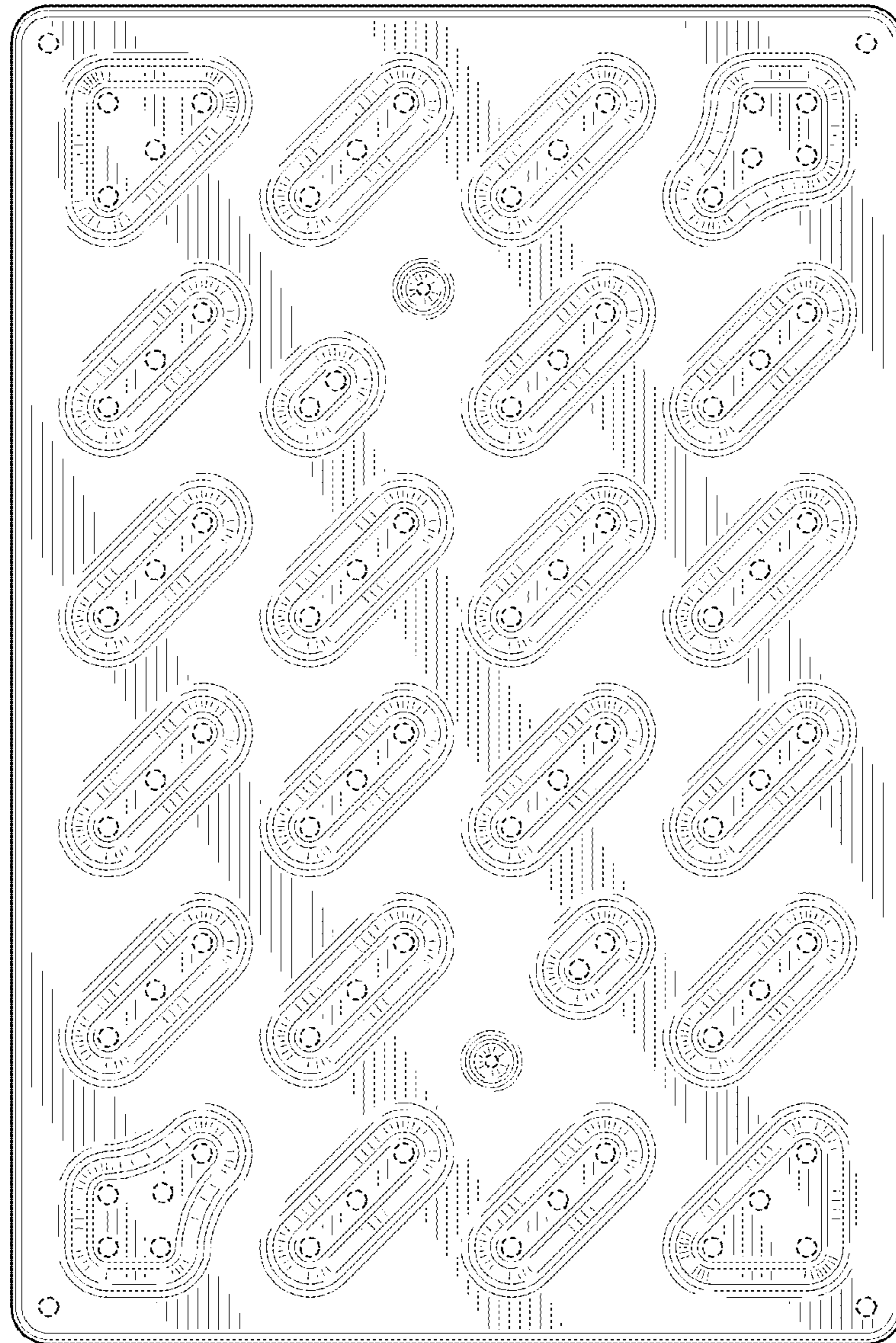

FIG. 3

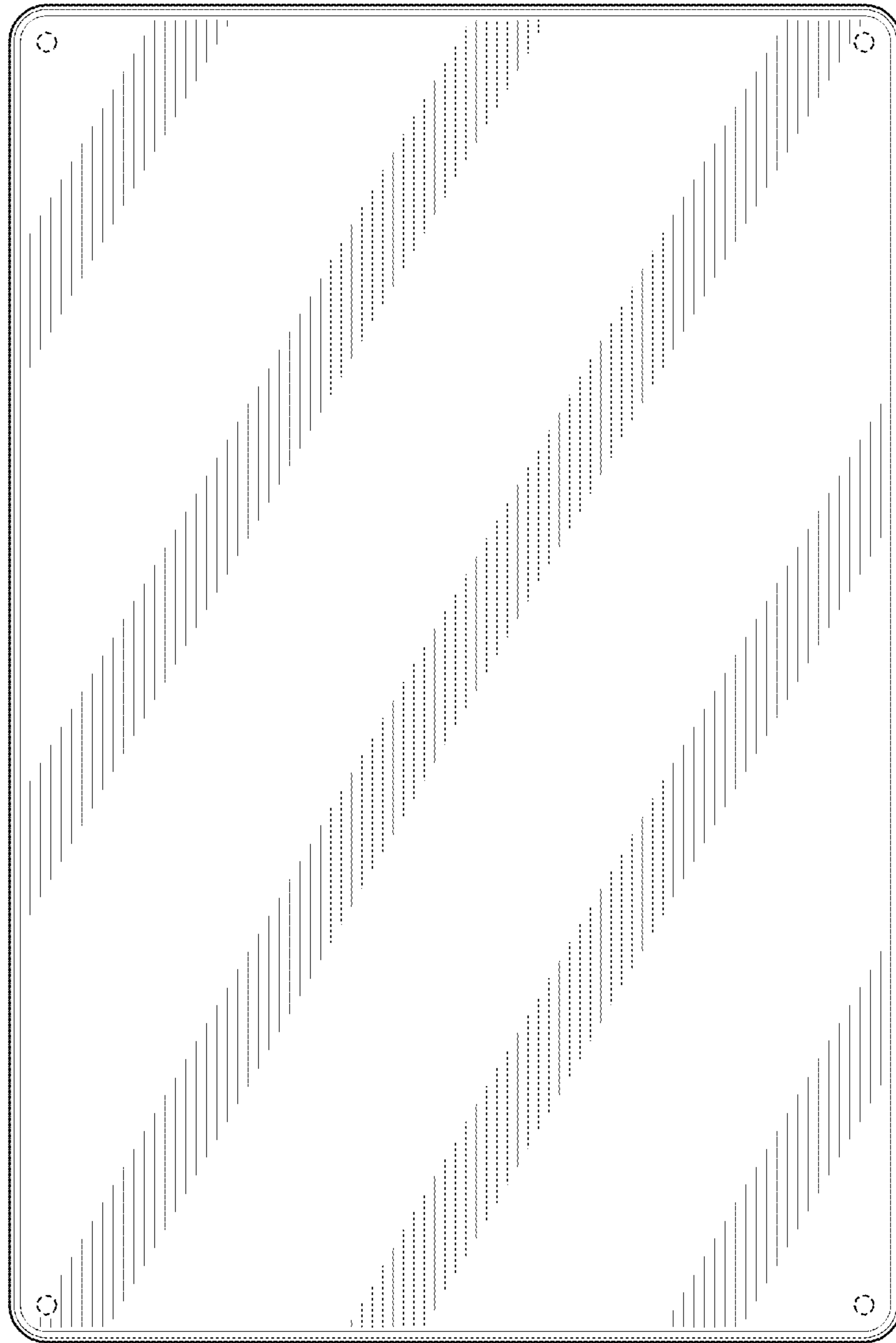

FIG. 4

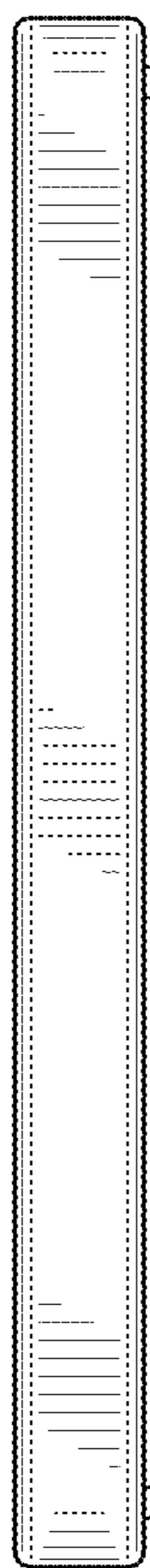

FIG. 5

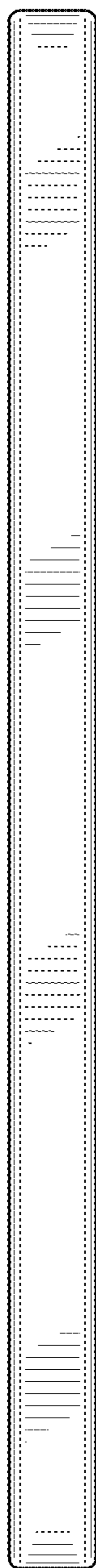

FIG. 6