



US00D681014S

(12) **United States Design Patent**
Ham et al.

(10) **Patent No.:** **US D681,014 S**
(45) **Date of Patent:** **** Apr. 30, 2013**

- (54) **MICROPHONE BOOM FOR A COMMUNICATIONS HEADSET**
- (75) Inventors: **Soohyun Ham**, San Francisco, CA (US);
Stefan Gougherty, Santa Cruz, CA (US); **John Kelley**, Santa Cruz, CA (US)
- (73) Assignee: **Plantronics, Inc.**, Santa Cruz, CA (US)
- (**) Term: **14 Years**
- (21) Appl. No.: **29/418,406**
- (22) Filed: **Apr. 16, 2012**
- (51) **LOC (9) Cl.** **14-01**
- (52) **U.S. Cl.**
USPC **D14/223; D14/206; D14/225**
- (58) **Field of Classification Search** D14/206,
D14/225, 227, 228, 205, 223; 181/129, 130,
181/135; 379/430, 431; 381/380, 381, 382;
455/90.3, 575.1
See application file for complete search history.

(56) **References Cited**

U.S. PATENT DOCUMENTS

D179,150	S *	11/1956	Norris	D14/192
3,101,155	A	8/1963	Hehr et al.		
3,209,080	A	9/1965	Guttner et al.		
4,617,431	A	10/1986	Scott et al.		
D354,568	S *	1/1995	Araki et al.	D24/174
D406,140	S *	2/1999	Hall et al.	D14/205
D449,039	S *	10/2001	Weikel et al.	D14/227
D451,907	S *	12/2001	Amae et al.	D14/223
D457,635	S	5/2002	Dittli et al.		
D463,784	S *	10/2002	Taylor et al.	D14/206
D474,178	S	5/2003	Eroma		
6,560,346	B2 *	5/2003	Ohta et al.	381/382
D498,227	S *	11/2004	Dyer et al.	D14/205
D504,419	S *	4/2005	Bey et al.	D14/223
D505,413	S *	5/2005	Skulley et al.	D14/223
D506,258	S *	6/2005	Nielsen	D24/174
D510,082	S *	9/2005	Olson et al.	D14/206

D511,156	S	11/2005	Eroma et al.		
D512,984	S	12/2005	Ham		
D517,528	S *	3/2006	Skulley	D14/206
D519,498	S	4/2006	Ham		
D520,496	S *	5/2006	Gwee	D14/223
D521,492	S *	5/2006	Ham	D14/205
D531,165	S *	10/2006	Rath	D14/206
D537,815	S *	3/2007	Bentley et al.	D14/225
D539,266	S	3/2007	Bentley et al.		

(Continued)

FOREIGN PATENT DOCUMENTS

WO 00/21333 4/2000

OTHER PUBLICATIONS

Looxcie Launches First Wearable Camcorder and Social Sharing System. Sep. 15, 2010. Sunnyvale, CA.

(Continued)

Primary Examiner — Paula Greene

(74) *Attorney, Agent, or Firm* — Michael Rodriguez

(57) **CLAIM**

The ornamental design for a microphone boom for a communications headset, as shown and described.

DESCRIPTION

FIG. 1 is a back top right perspective view of a microphone boom for a communications headset showing our new design, the microphone boom is drawn broken away for indeterminate length;

FIG. 2 is a front view thereof;

FIG. 3 is a back view thereof;

FIG. 4 is a right side view thereof;

FIG. 5 is a left side view thereof;

FIG. 6 is a bottom view thereof; and,

FIG. 7 is a top view thereof.

The broken lines showing of the unclaimed environment forms no part of the claimed design.

1 Claim, 3 Drawing Sheets

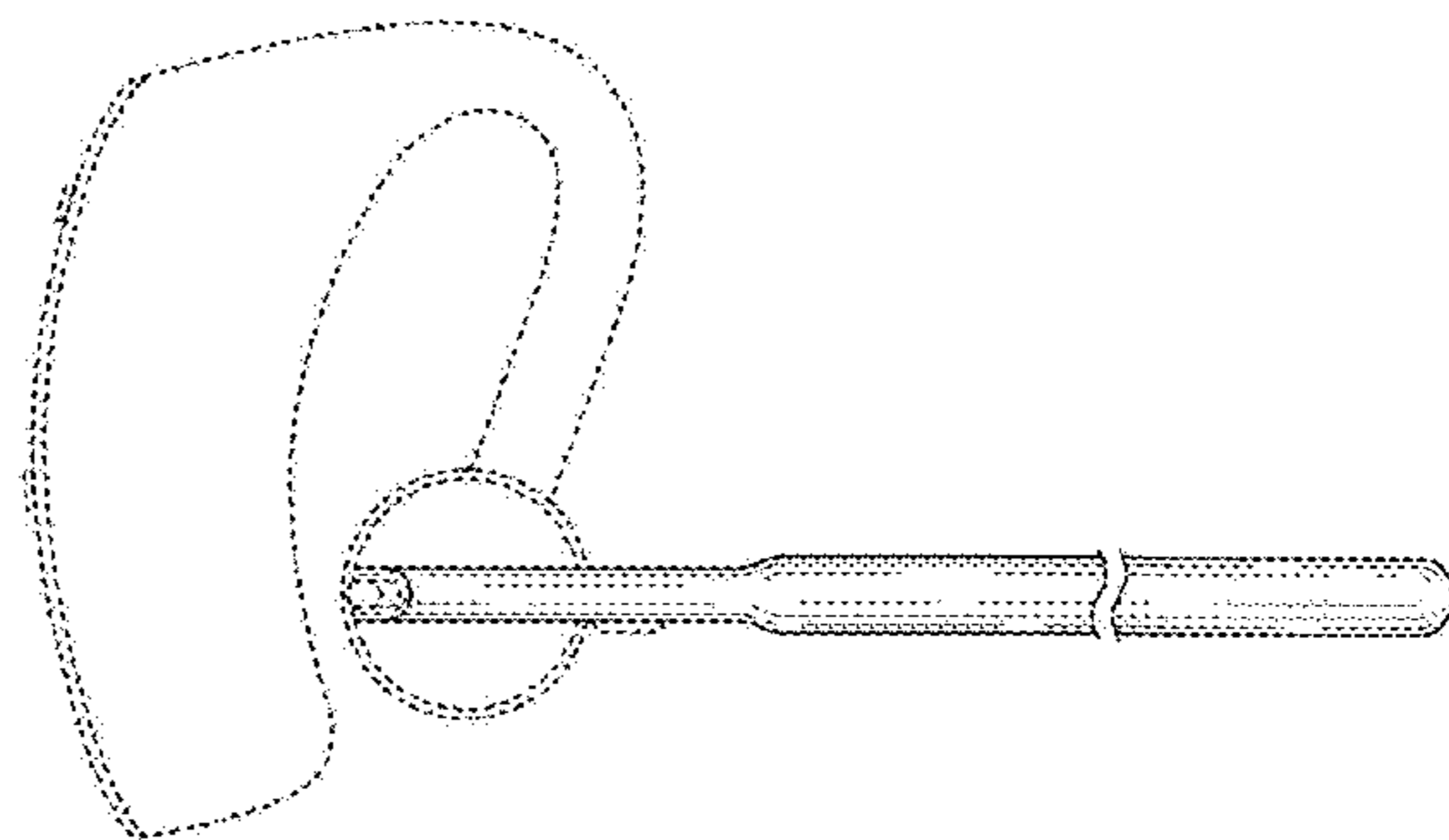
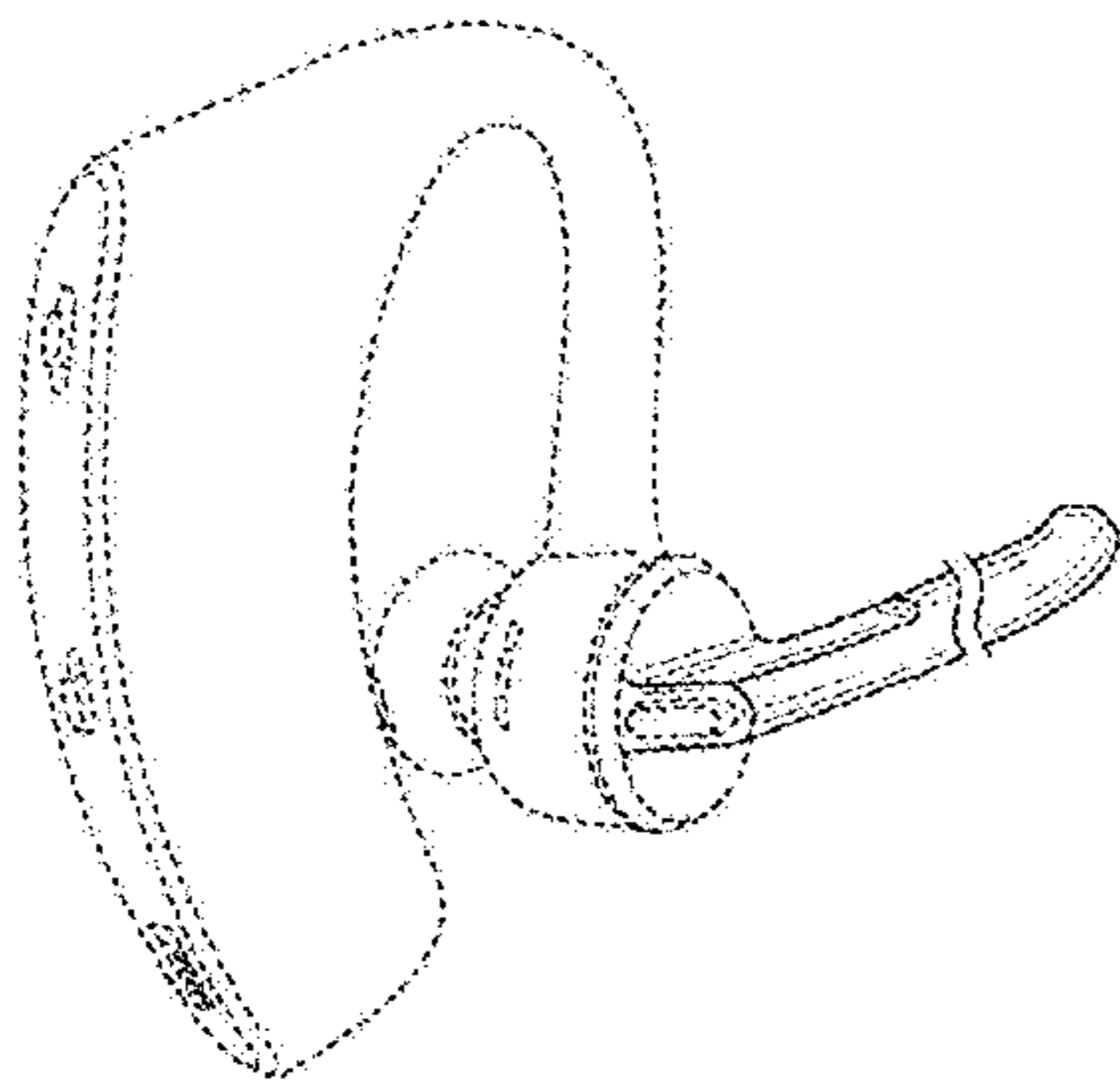

US D681,014 S

Page 2

U.S. PATENT DOCUMENTS

D540,313 S * 4/2007 Rausch et al. D14/225
D540,778 S * 4/2007 Thompson et al. D14/206
D541,787 S * 5/2007 Ma D14/205
D567,220 S * 4/2008 Wang D14/206
D589,492 S * 3/2009 Mistry D14/205
D589,934 S * 4/2009 Esses D14/206
D597,072 S * 7/2009 Asai D14/206
D602,001 S * 10/2009 Bentley D14/206
D602,906 S * 10/2009 Groves et al. D14/205
D603,372 S * 11/2009 Bentley D14/206
D612,834 S 3/2010 Yang et al.
D612,835 S 3/2010 Yang et al.
D612,840 S 3/2010 Yang et al.

D617,771 S * 6/2010 Groves et al. D14/206
D643,405 S * 8/2011 Rath D14/206
D647,877 S * 11/2011 Son D14/206
8,061,473 B1 * 11/2011 Kerr 181/135
D652,017 S * 1/2012 Groves et al. D14/206
D657,347 S 4/2012 Chung et al.
D670,267 S * 11/2012 Maddern D14/206
D671,915 S * 12/2012 Birger D14/206

OTHER PUBLICATIONS

Nokia Design Registration No. 23677. Application No. 20030252.
Publication Date: Jun 15, 2004.

* cited by examiner

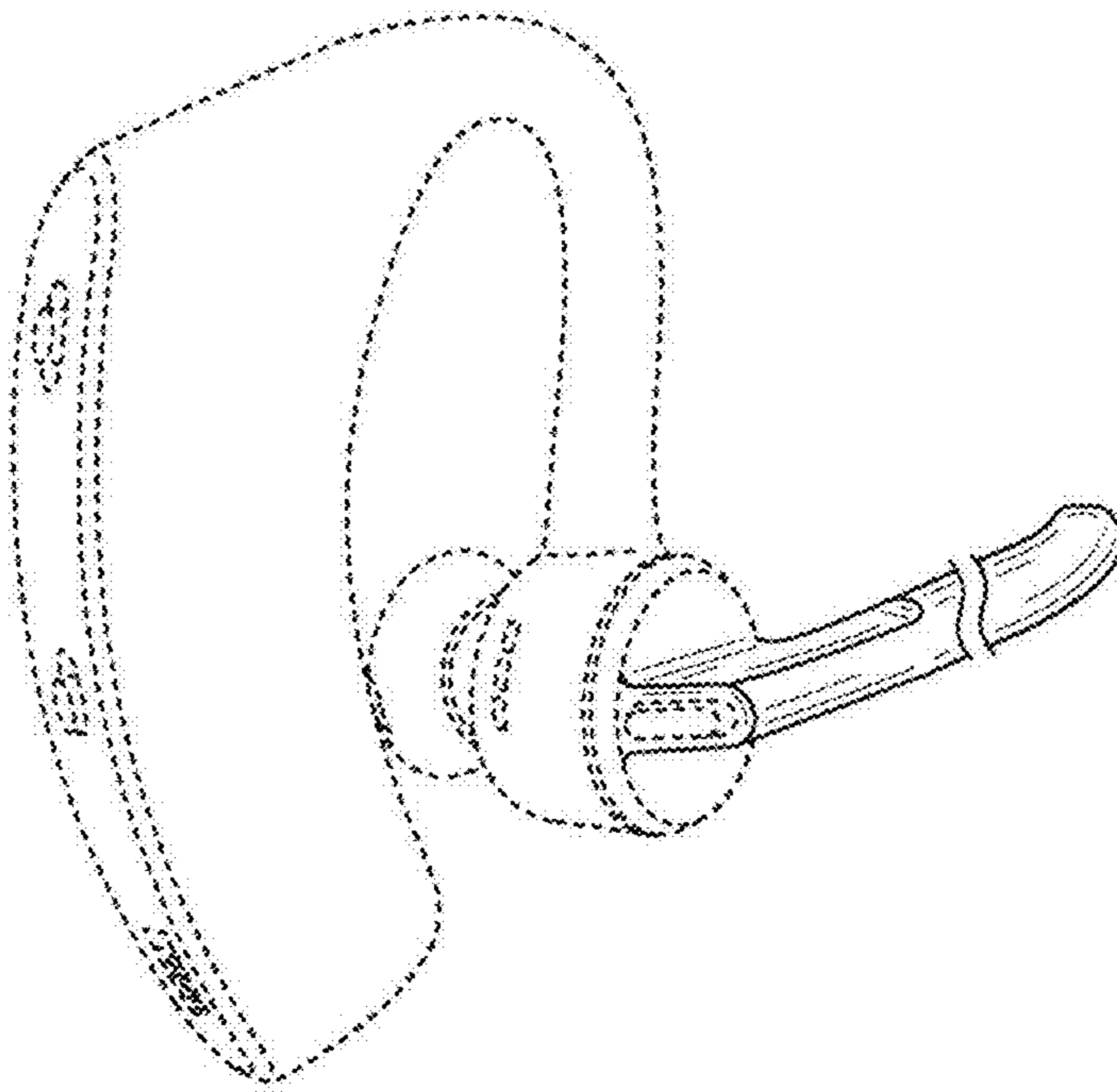

FIG. 1

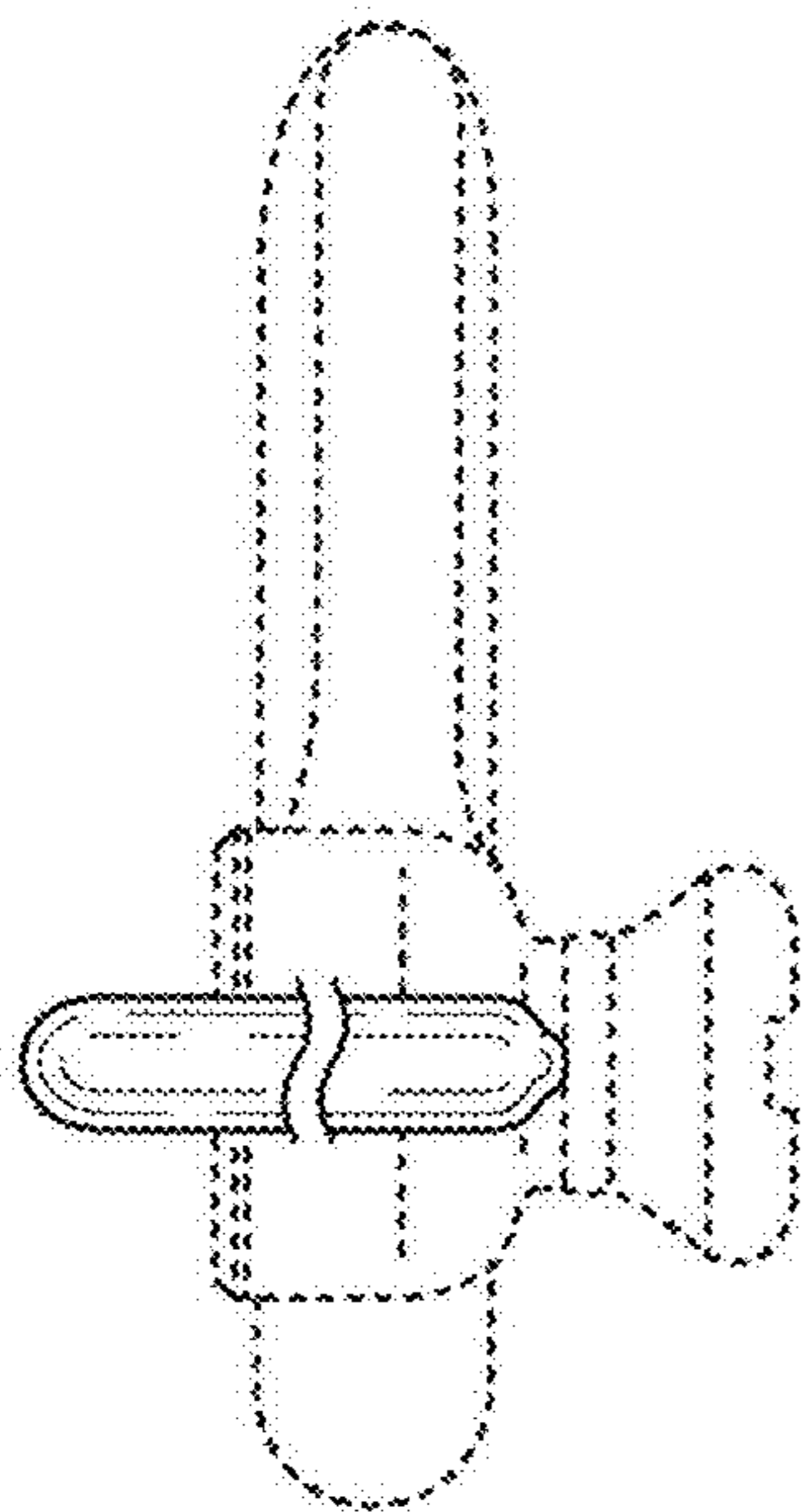

FIG. 2

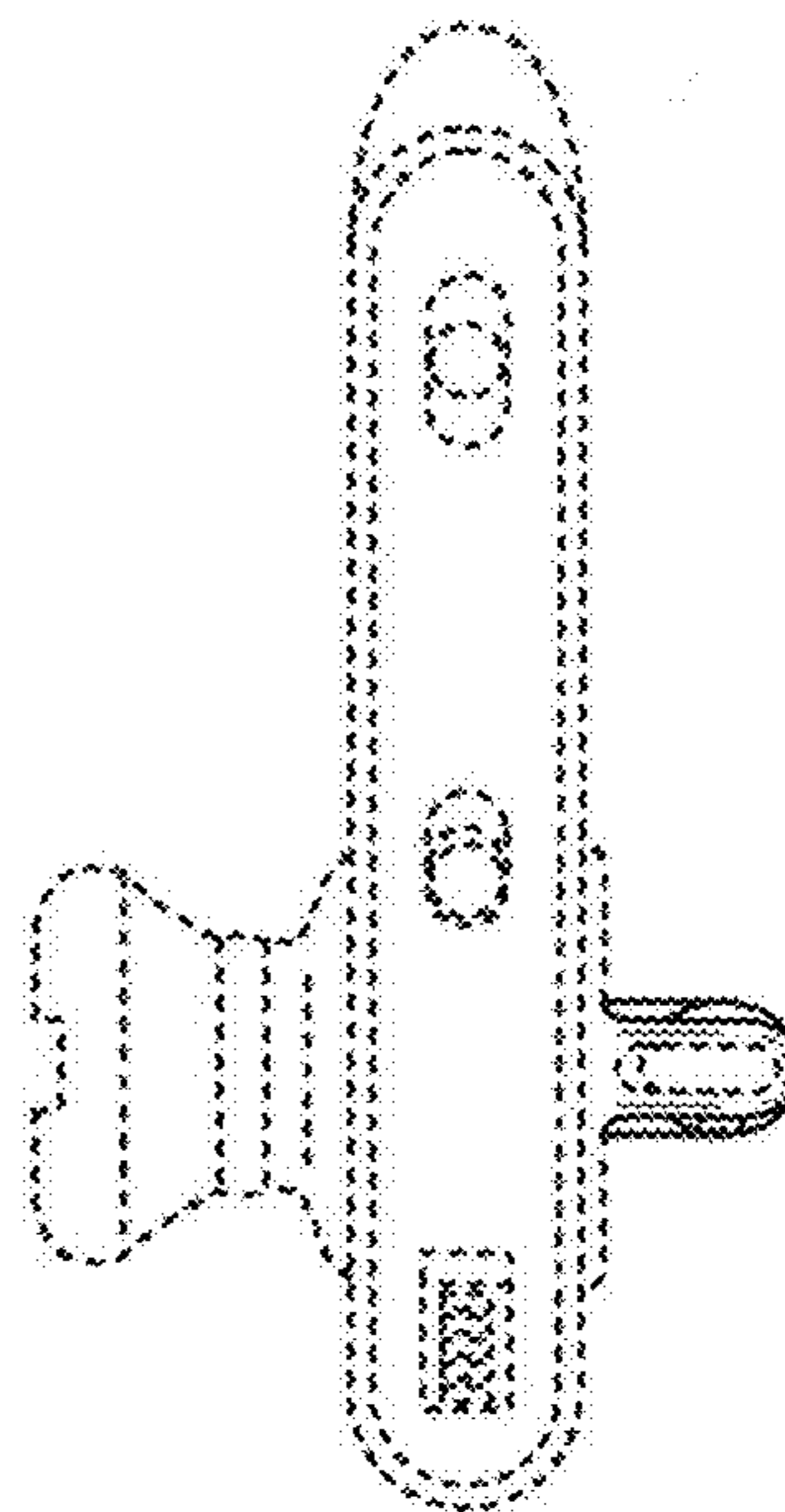

FIG. 3

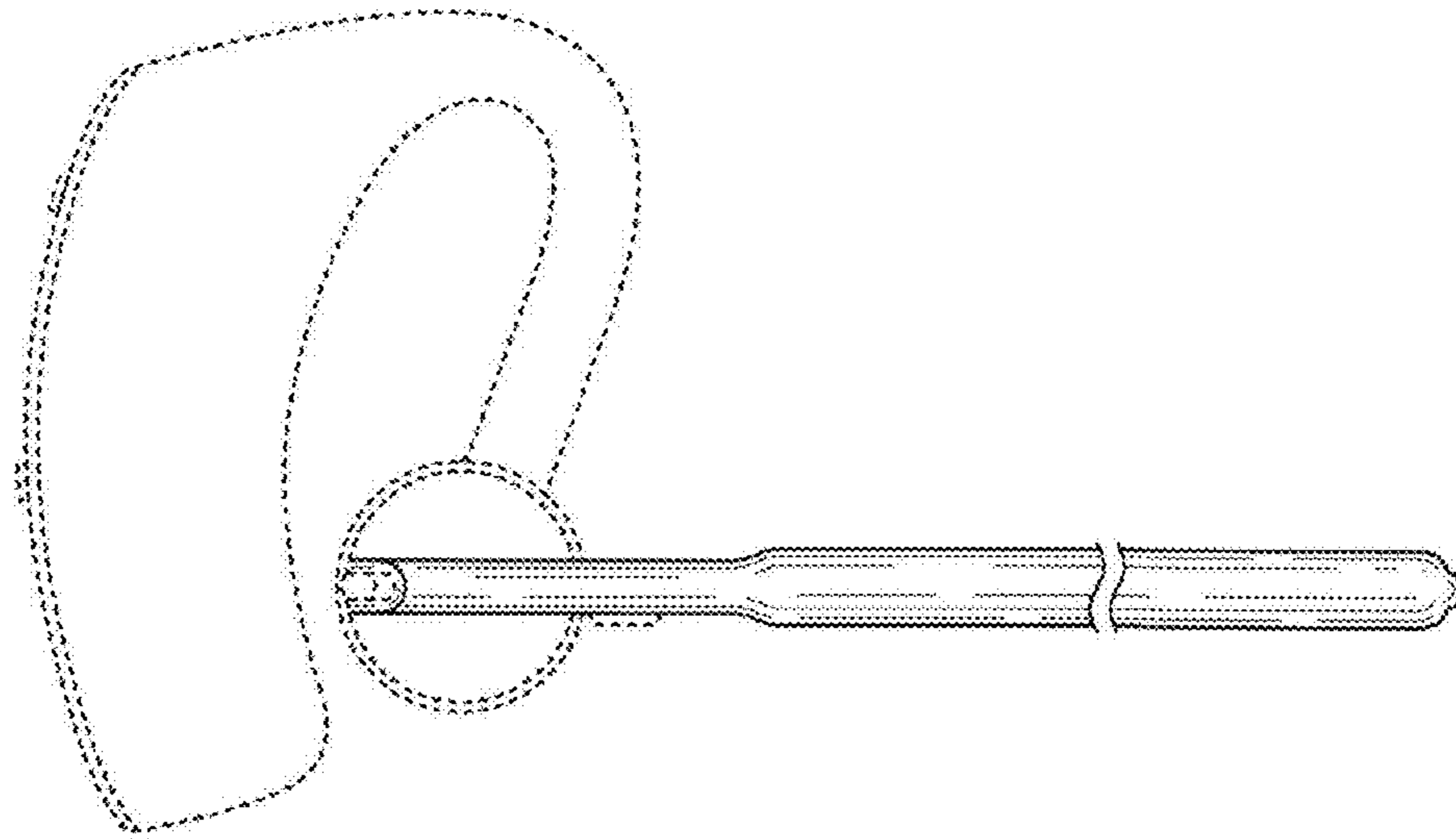

FIG. 4

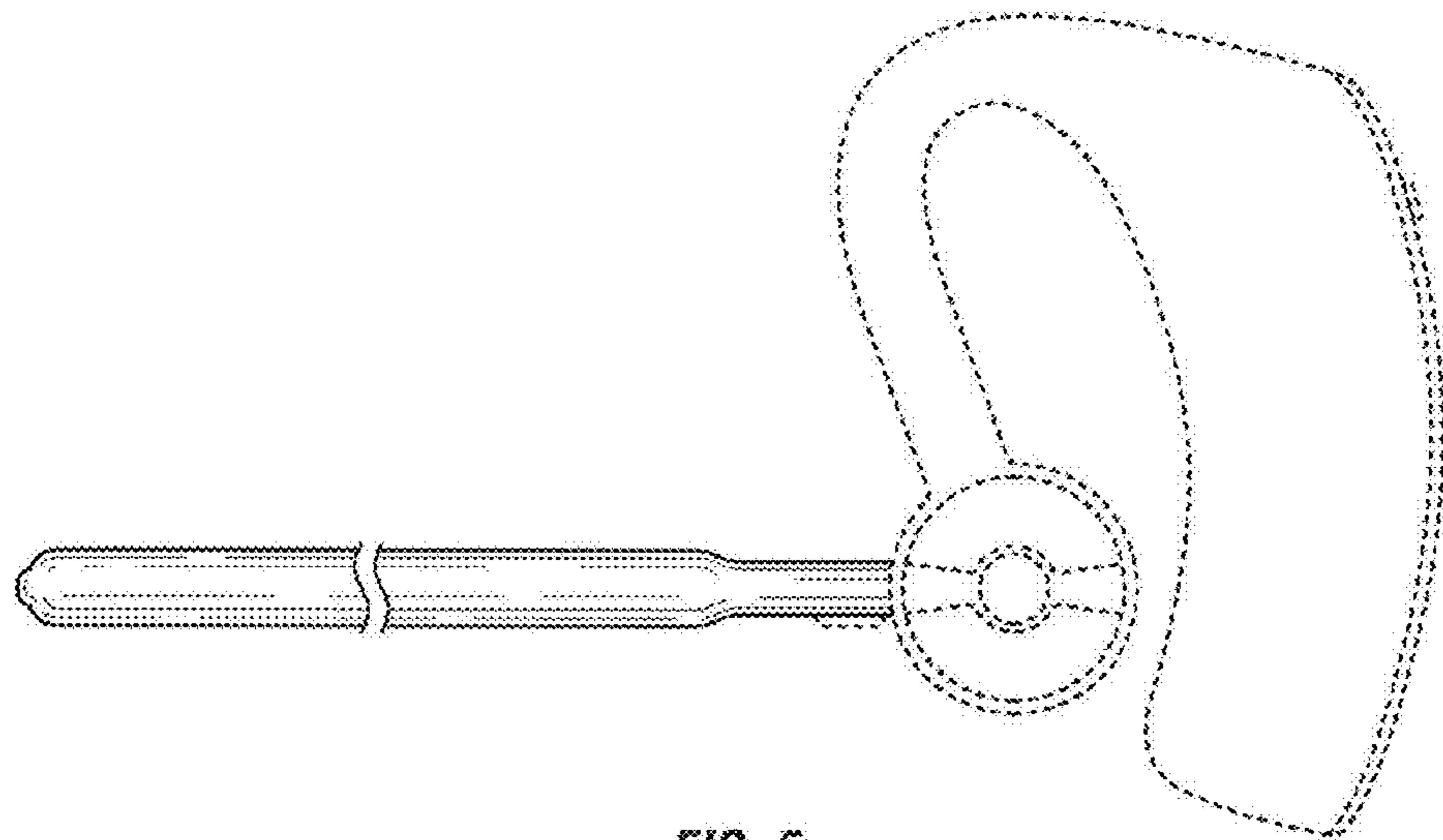

FIG. 5

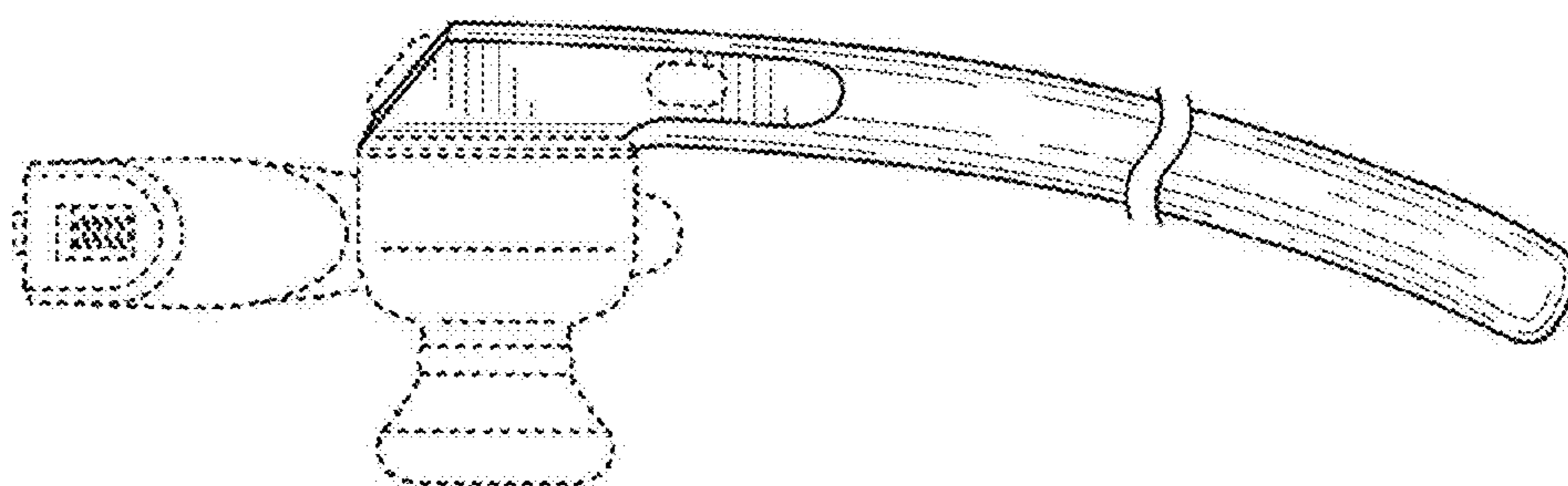

FIG. 6

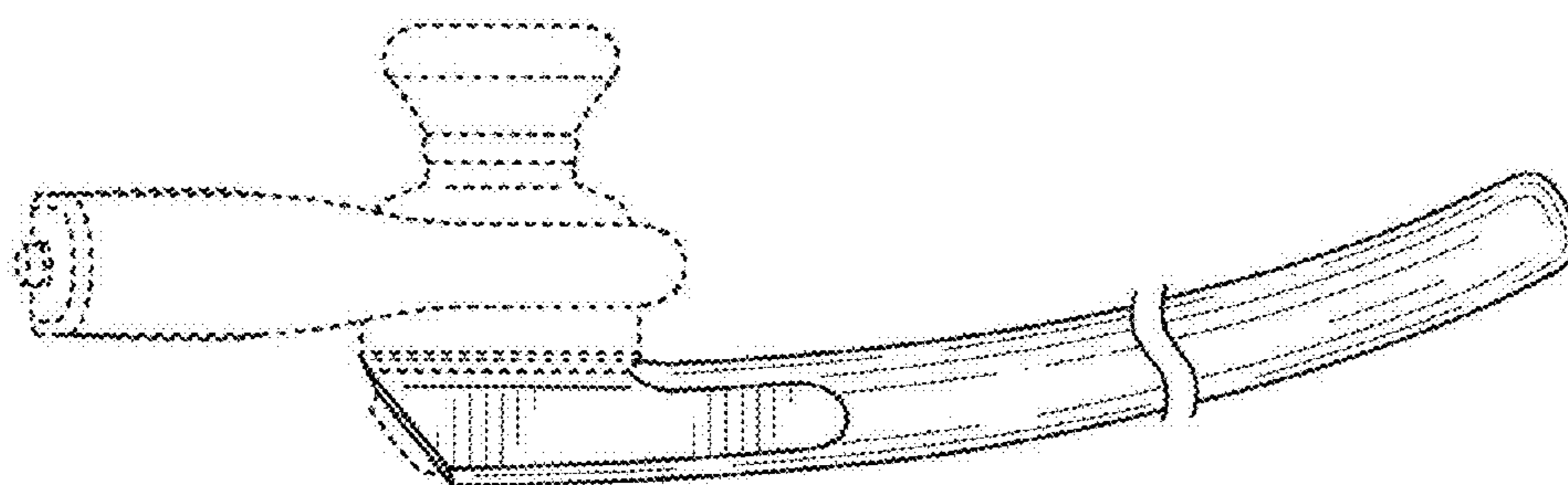

FIG. 7