



US00D680996S

(12) **United States Design Patent**
Park et al.

(10) **Patent No.:** **US D680,996 S**
(45) **Date of Patent:** **** Apr. 30, 2013**

(54) **MOBILE COMMUNICATION TERMINAL**

(75) Inventors: **Dae-Yoeb Park**, Gimpo-si (KR);
Sung-Kwon Kim, Seoul (KR);
Jun-Sang Park, Anyang-si (KR)

(73) Assignee: **Samsung Electronics Co., Ltd.**,
Suwon-Si (KR)

(**) Term: **14 Years**

(21) Appl. No.: **29/423,194**

(22) Filed: **May 30, 2012**

(30) **Foreign Application Priority Data**

Feb. 23, 2012 (KR) 30-2012-0008373

(51) **LOC (9) Cl.** **14-03**

(52) **U.S. Cl.**
USPC **D14/138 AA**

(58) **Field of Classification Search** D14/138 G,
D14/138 AD, 341, 346, 138 R, 138 AA, 496,
D14/203.1, 203.4, 203.7, 248, 218; 455/575.1,
455/556.2, 575.3, 575.4; D21/517; 379/433.01,
379/433.04, 433.12, 433.13; D10/65, 78,
D10/104; D13/168

See application file for complete search history.

(56) **References Cited**

U.S. PATENT DOCUMENTS

D593,556 S * 6/2009 Hofer et al. D14/346
D597,511 S * 8/2009 Park D14/138 AA
D603,831 S * 11/2009 Ho et al. D14/138 AA
D603,832 S * 11/2009 Ho D14/138 AA
D603,833 S * 11/2009 Ho et al. D14/138 AA
D608,329 S * 1/2010 Kim et al. D14/138 AA
D612,849 S * 3/2010 Ferrari et al. D14/346
D613,740 S * 4/2010 Ferrari et al. D14/346
D622,247 S * 8/2010 Kwon et al. D14/138 AA
D628,550 S * 12/2010 Chen D14/138 AA
D628,973 S * 12/2010 Ku D14/138 AA

D637,577 S * 5/2011 Han et al. D14/138 AA
D641,356 S * 7/2011 Ferrari et al. D14/346
D642,153 S * 7/2011 Nilsen et al. D14/138 AA
D647,870 S * 11/2011 Lee D14/138 AA

(Continued)

OTHER PUBLICATIONS

LG C360 telephone, announced 2011, [online], [site visited Dec. 13, 2012]. Available from Internet, <URL: http://www.gsmarena.com/lg_c360-4635.php>.*

(Continued)

Primary Examiner — Jeffrey D Asch

(74) *Attorney, Agent, or Firm* — Staas & Halsey LLP

(57) **CLAIM**

The ornamental design for a mobile communication terminal, as shown and described.

DESCRIPTION

FIG. 1 is a front perspective view of a mobile communication terminal;

FIG. 2 is a front view of the mobile communication terminal of FIG. 1;

FIG. 3 is a rear view of the mobile communication terminal of FIG. 1;

FIG. 4 is a left-side view of the mobile communication terminal of FIG. 1;

FIG. 5 is a right-side view of the mobile communication terminal of FIG. 1;

FIG. 6 is a top plan view of the mobile communication terminal of FIG. 1; and,

FIG. 7 is a bottom plan view of the mobile communication terminal of FIG. 1.

The broken lines shown in the figures that are immediately adjacent to the shaded areas and define unshaded regions, represent the bounds of the claim, while all other broken lines are directed to environment and are for illustrative purposes only; the broken lines form no part of the claimed design.

1 Claim, 7 Drawing Sheets

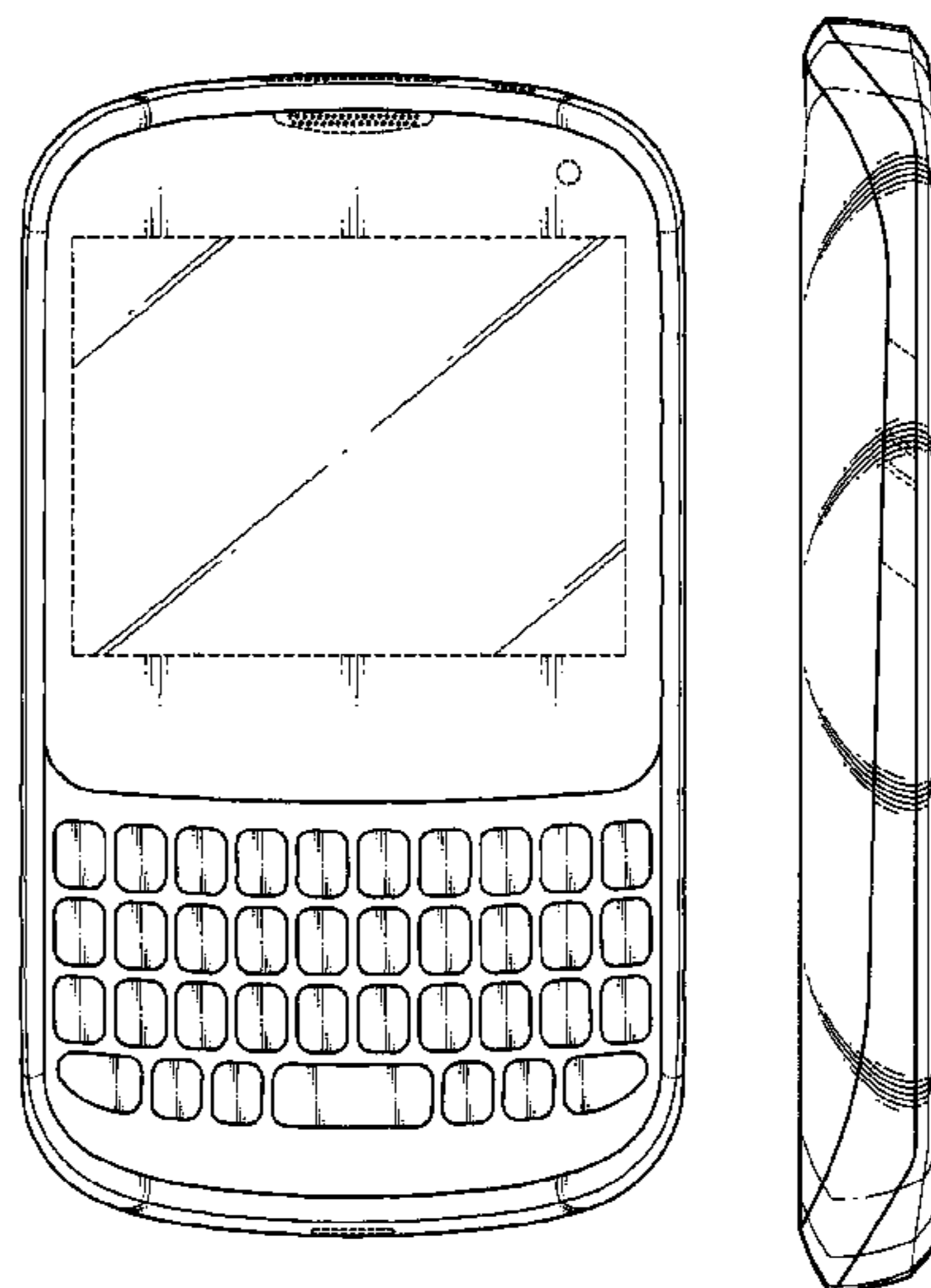

U.S. PATENT DOCUMENTS

D647,900	S	*	11/2011	Ferrari et al.	D14/346
D648,699	S	*	11/2011	Park et al.	D14/138 AA
D649,952	S	*	12/2011	Lee	D14/138 AA
D658,623	S	*	5/2012	Park et al.	D14/138 AA
D658,624	S	*	5/2012	Ferrari et al.	D14/138 AA
D660,817	S	*	5/2012	Ferrari et al.	D14/138 AA
D661,278	S	*	6/2012	Wang	D14/138 AA
D671,903	S	*	12/2012	Geum	D14/138 AA
2006/0209032	A1	*	9/2006	Chiang et al.	345/169

OTHER PUBLICATIONS

LG Optimus Pro C660 telephone, announced Jul. 2011, [online], [site visited Dec. 13, 2012]. Available from Internet, <URL: http://www.gsmarena.com/lg_optimus_pro_c660-4040.php>.*

Alcatel OT-803 telephone, announced Feb. 2011, [online], [site visited Dec. 13, 2012]. Available from Internet, <URL: http://www.gsmarena.com/alcatel_ot_803-3801.php>.*

Alcatel OT-358 telephone, announced Apr. 2012, [online], [site visited Dec. 13, 2012]. Available from Internet, <URL: http://www.gsmarena.com/alcatel_ot_358-4727.php>.*

Plum Blast telephone, announced Jan. 2011, [online], [site visited Dec. 13, 2012]. Available from Internet, <URL: http://www.gsmarena.com/plum_blast-4150.php>.*

Plum Velocity telephone, announced Sep. 2011, [online], [site visited Dec. 13, 2012]. Available from Internet, <URL: http://www.gsmarena.com/plum_velocity-4186.php>.*

Samsung Ch@t 357 telephone, announced Q3 2012, [online], [site visited Dec. 13, 2012]. Available from Internet, <URL: http://www.gsmarena.com/samsung_ch@t_357-4931.php>.*

BlackBerry Curve 9320 telephone, announced May 2012, [online], [site visited Dec. 13, 2012]. Available from Internet, <URL: http://www.gsmarena.com/blackberry_curve_9320-4458.php>.*

BlackBerry Curve 9220 telephone, announced Apr. 2012, [online], [site visited Dec. 13, 2012]. Available from Internet, <URL: http://www.gsmarena.com/blackberry_curve_9220-4459.php>.*

* cited by examiner

FIG. 1

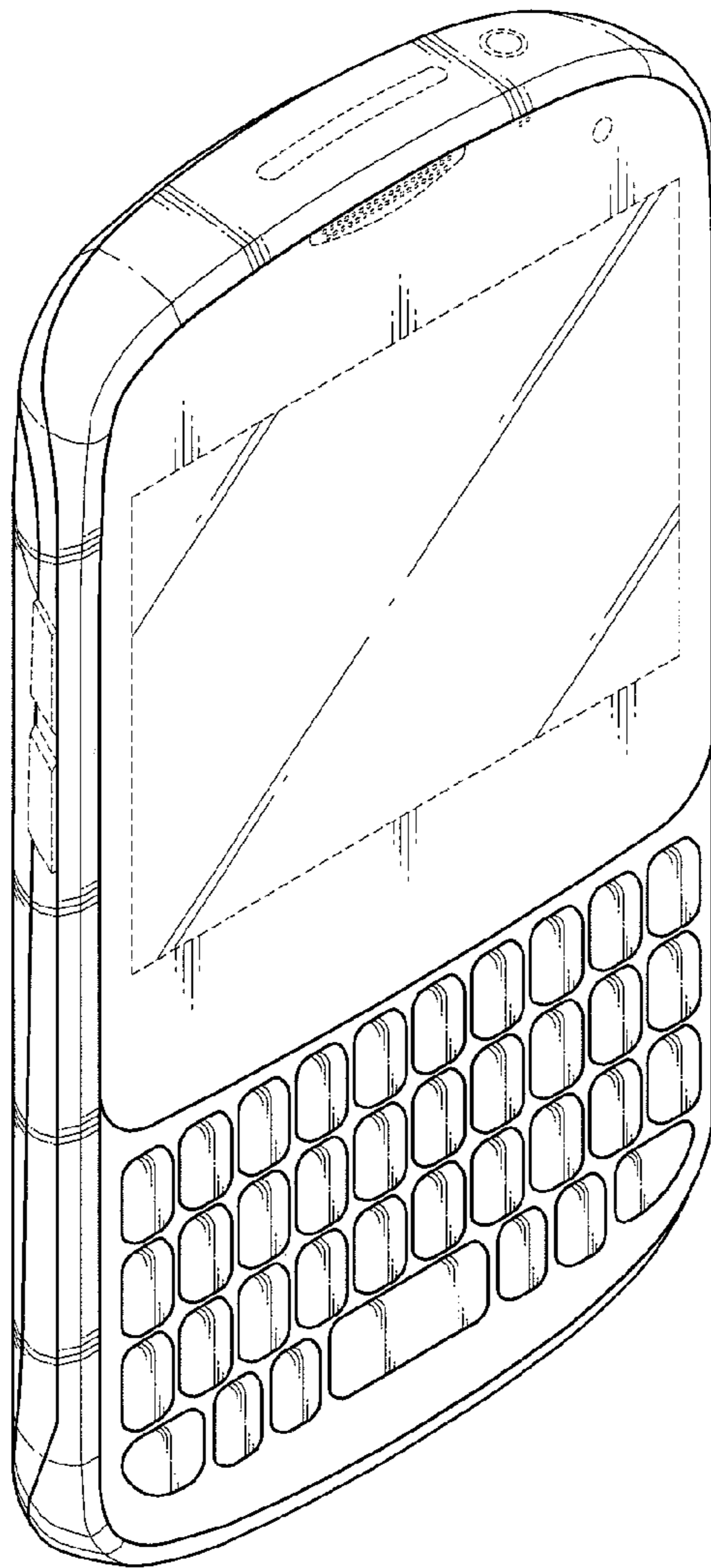

FIG. 2

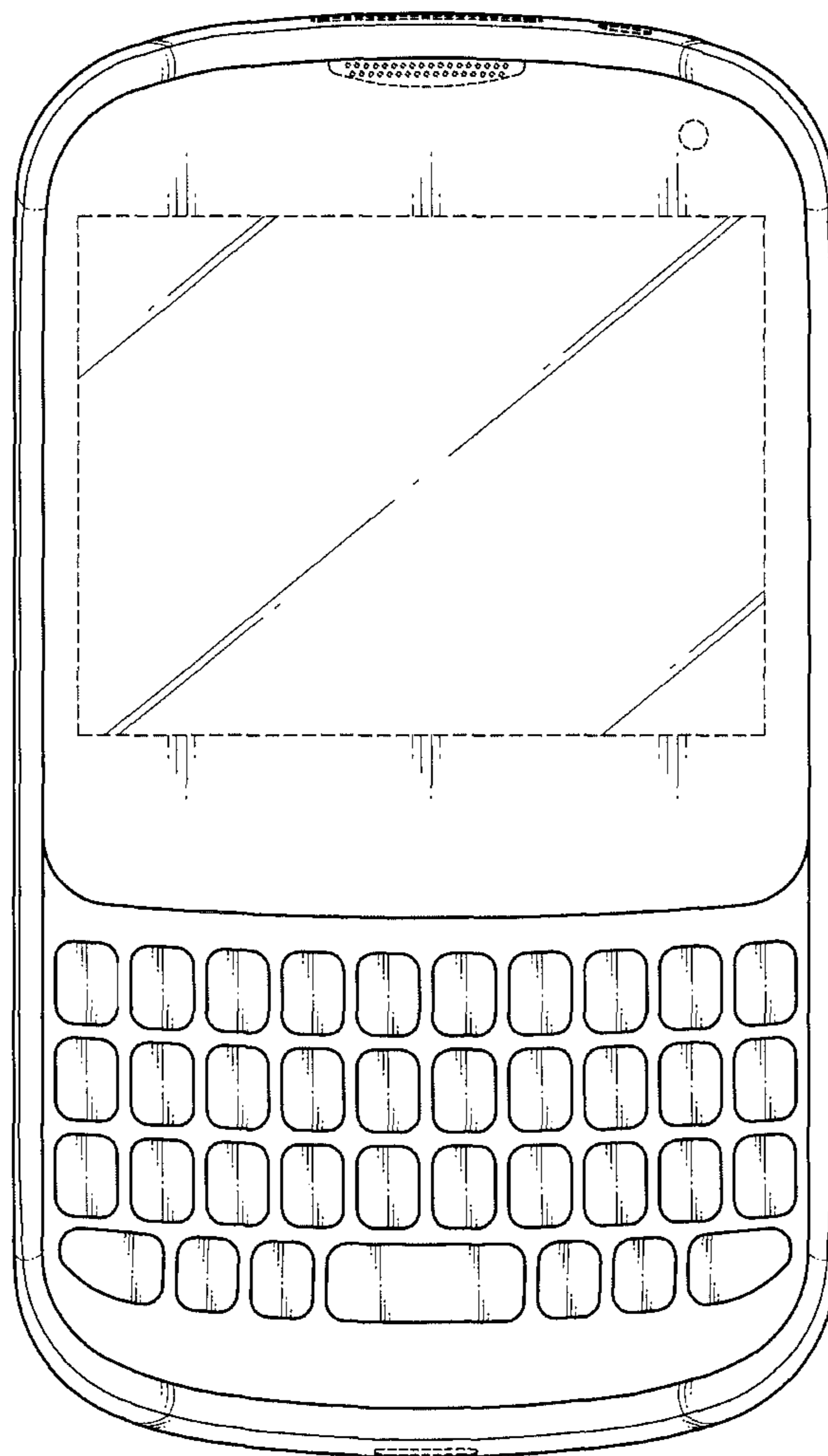

FIG. 3

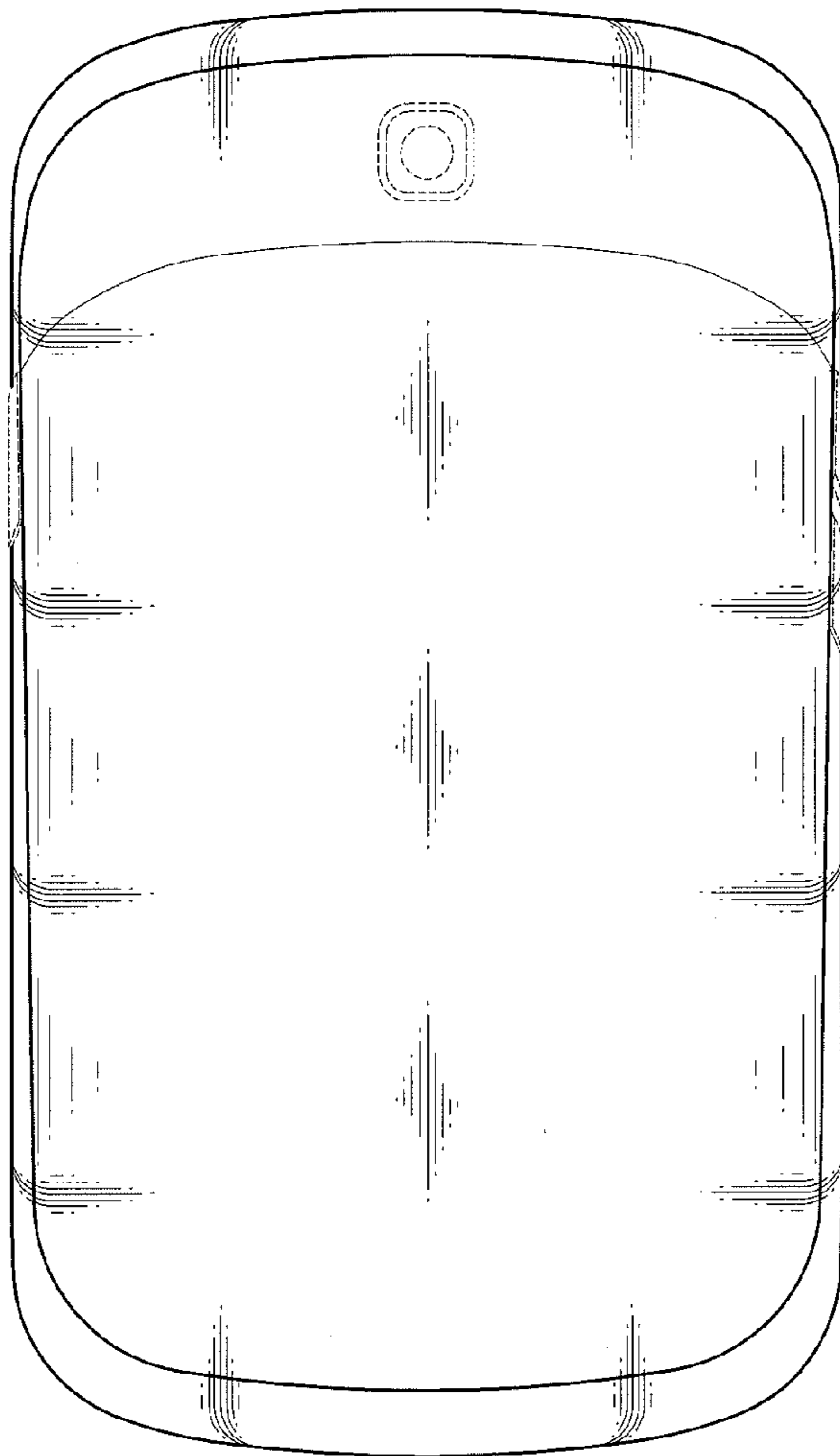

FIG. 4

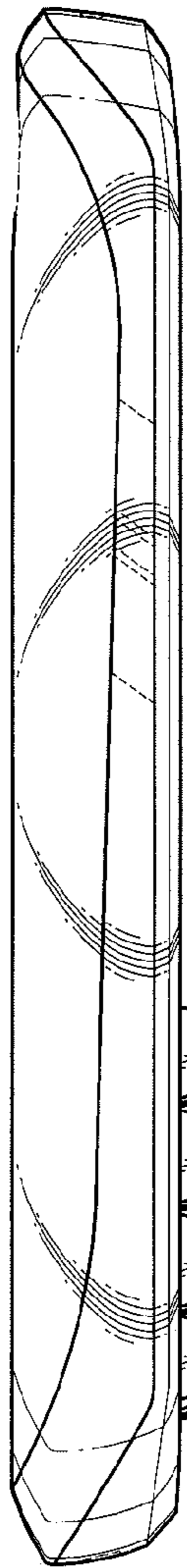

FIG. 5

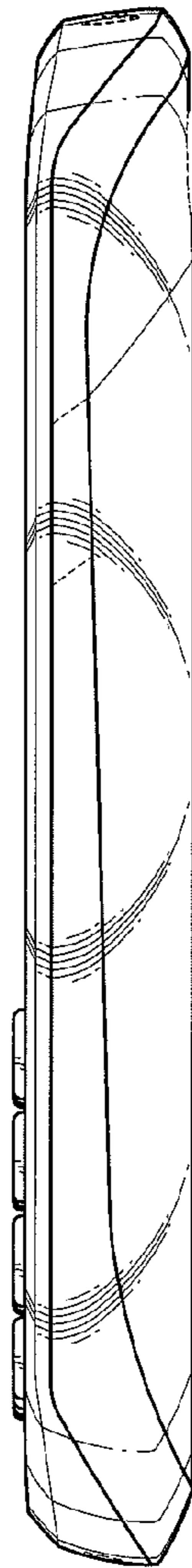

FIG. 6

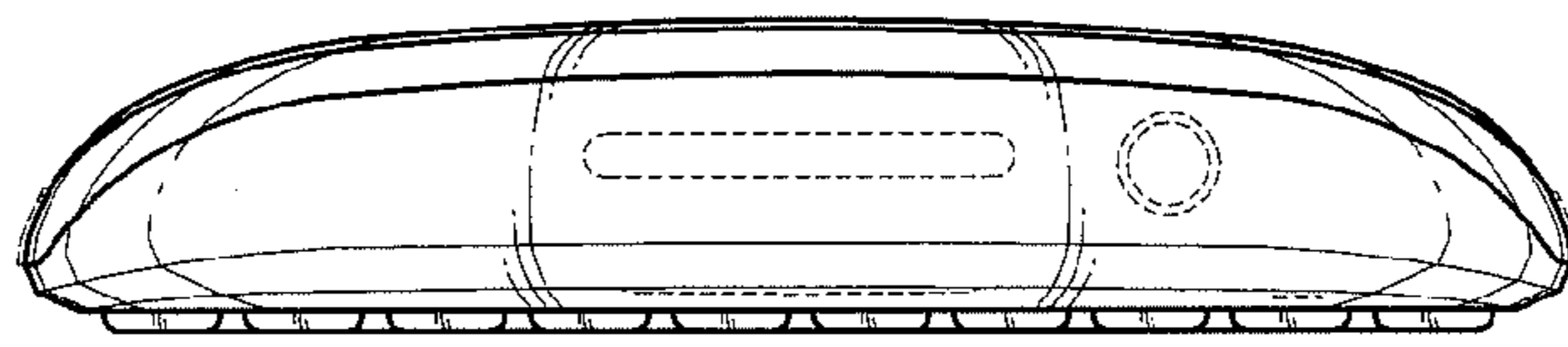

FIG. 7

