



US00D680985S

(12) **United States Design Patent**  
**Kangasmaa**

(10) **Patent No.:** **US D680,985 S**  
(45) **Date of Patent:** **\*\* Apr. 30, 2013**

(54) **HANDSET**

(75) Inventor: **Heikki Kangasmaa**, Espoo (FI)

(73) Assignee: **Nokia Corporation** (FI)

(\*\*) Term: **14 Years**

(21) Appl. No.: **29/413,793**

(22) Filed: **Feb. 21, 2012**

(51) **LOC (9) Cl.** ..... **14-03**

(52) **U.S. Cl.**  
USPC ..... **D14/138 G**

(58) **Field of Classification Search** ..... D14/138 G,  
D14/138 AD, 341, 346, 138 R, 138 AA, 138 AC,  
D14/138 C, 496, 203.1, 203.4, 203.7, 248,  
D14/218; 455/575.1, 556.2, 575.3, 575.4;  
D21/517; 379/433.01, 433.04; D10/65,  
D10/78, 104; D13/168  
See application file for complete search history.

(56) **References Cited**

U.S. PATENT DOCUMENTS

- D578,503 S \* 10/2008 Shin et al. .... D14/138 AD
- D585,411 S 1/2009 Eaton
- D594,836 S \* 6/2009 Harju ..... D14/138 AD
- D597,537 S 8/2009 Eaton
- D602,463 S \* 10/2009 Eguchi ..... D14/138 G
- D605,623 S \* 12/2009 Aarras ..... D14/138 AD
- D606,038 S 12/2009 Aarras
- D617,755 S 6/2010 Leinvuo
- D618,655 S 6/2010 Sandberg
- D619,983 S \* 7/2010 Fujimura et al. .... D14/138 G
- D620,467 S \* 7/2010 Aarras ..... D14/138 G
- D625,700 S 10/2010 Sandberg et al.
- D629,376 S 12/2010 Choi et al.
- D629,377 S 12/2010 Ivaskevicius
- D629,772 S \* 12/2010 Mo et al. .... D14/138 G
- D629,784 S 12/2010 Forsyth
- D633,888 S 3/2011 Eguchi
- D634,290 S 3/2011 Landwehr

- D634,294 S 3/2011 Dhondt
- D635,954 S 4/2011 Aarras
- D635,967 S 4/2011 Montin et al.
- D636,364 S 4/2011 Sandberg
- D637,576 S \* 5/2011 Lee ..... D14/138 AD
- D637,992 S 5/2011 Tom et al.
- D639,770 S 6/2011 Choi
- D640,222 S 6/2011 Dearsley
- D640,225 S 6/2011 Choi
- D644,196 S \* 8/2011 Lee et al. .... D14/138 AD
- D645,442 S 9/2011 Landwehr
- D646,248 S \* 10/2011 Lee ..... D14/138 G

(Continued)

OTHER PUBLICATIONS

Nokia 808 PureView telephone, announced Feb. 2012, [online], [site visited Nov. 21, 2012]. Available from Internet, <URL: [http://www.gsmarena.com/nokia\\_808\\_pureview-4577.php](http://www.gsmarena.com/nokia_808_pureview-4577.php)>.\*

(Continued)

*Primary Examiner* — Jeffrey D Asch

(74) *Attorney, Agent, or Firm* — Banner & Witcoff, Ltd.

(57) **CLAIM**

The ornamental design for a handset, as shown and described.

**DESCRIPTION**

FIG. 1 is a perspective view of a handset showing my new design;  
FIG. 2 is a front view thereof;  
FIG. 3 is a rear view thereof;  
FIG. 4 is a left side view thereof;  
FIG. 5 is a right side view thereof;  
FIG. 6 is a top view thereof; and,  
FIG. 7 is a bottom view thereof.  
The broken lines of the handset in the figures and the unshaded regions therein are for illustrative purposes only and form no part of the claimed design.

**1 Claim, 5 Drawing Sheets**

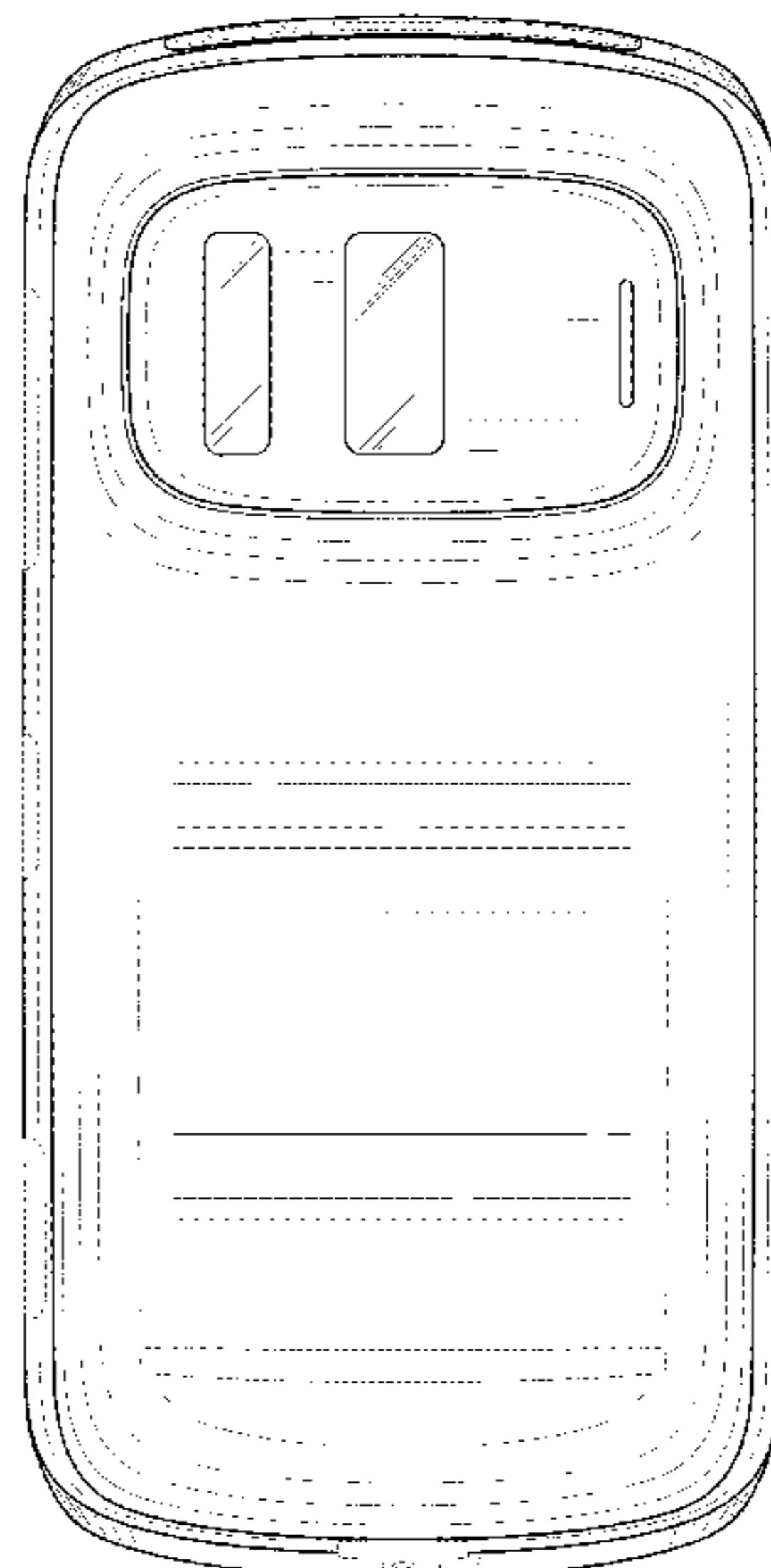
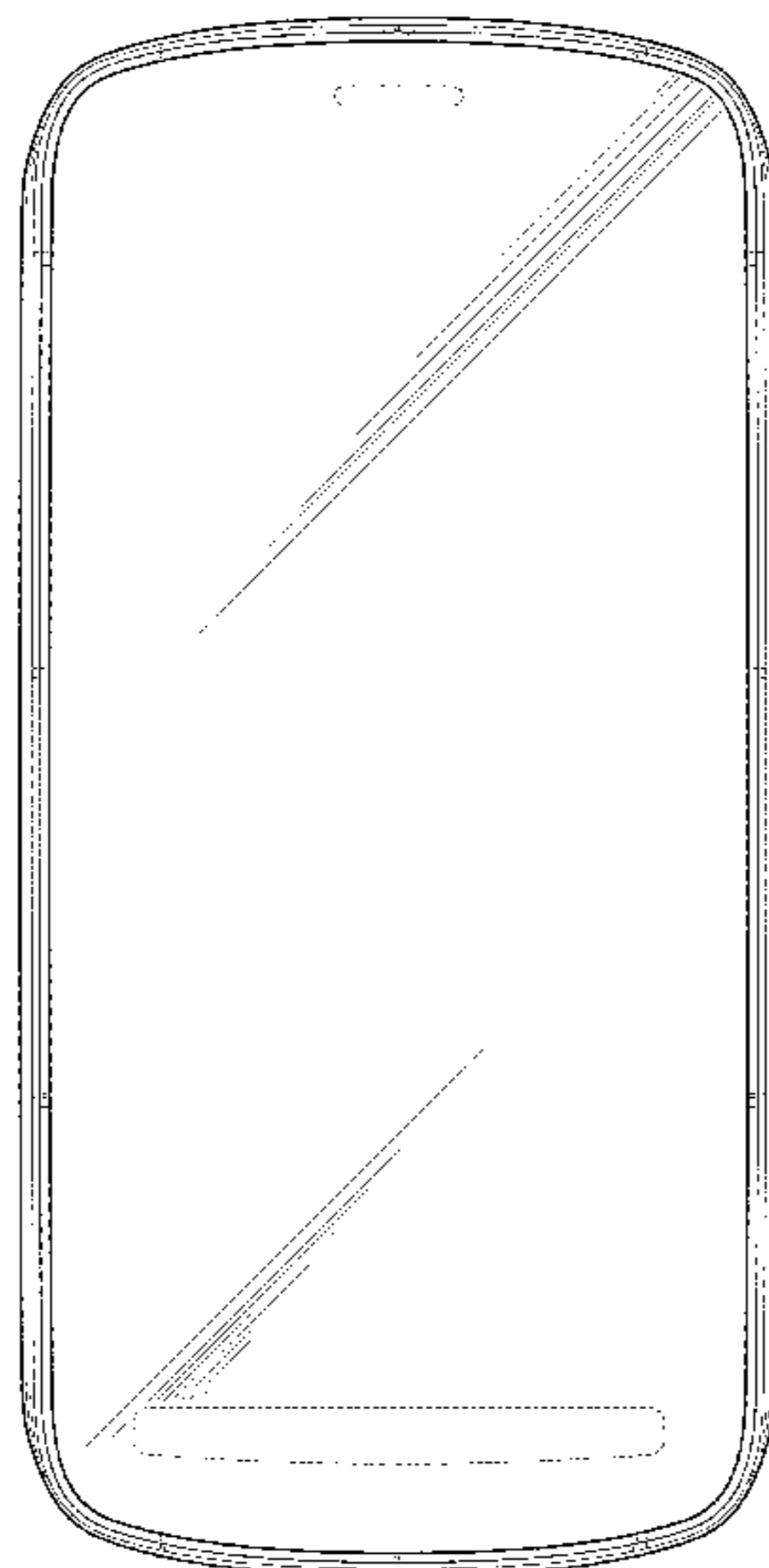

U.S. PATENT DOCUMENTS

D647,499	S	*	10/2011	Page et al. ....	D14/138 AD
D648,712	S		11/2011	Brickstad	
D650,347	S		12/2011	Wong	
D650,349	S		12/2011	Tom et al.	
D650,350	S		12/2011	Wong	
D651,998	S		1/2012	Marsh	
D652,000	S		1/2012	Liu	
D652,001	S		1/2012	Yang	
D652,003	S	*	1/2012	Park et al. ....	D14/138 G
D652,403	S		1/2012	Fahlgren et al.	
D652,815	S		1/2012	Wong	
D653,246	S		1/2012	Salazar et al.	
D654,036	S		2/2012	Wozniak	
D654,459	S	*	2/2012	Kim .....	D14/138 AD
D654,905	S		2/2012	Forsyth	
D655,698	S		3/2012	Forsyth	
D656,917	S		4/2012	Tom et al.	
D657,764	S	*	4/2012	Hong .....	D14/138 G
D658,620	S		5/2012	Lylyk	
D658,621	S		5/2012	Lylyk	
D663,710	S	*	7/2012	Park .....	D14/138 G
D665,761	S	*	8/2012	Russo .....	D14/138 G
D665,764	S	*	8/2012	Shi et al. ....	D14/138 G
D666,570	S	*	9/2012	Kim et al. ....	D14/138 G
D670,262	S	*	11/2012	Mitchell et al. ....	D14/138 G

OTHER PUBLICATIONS

Nokia 603 telephone, announced Oct. 2011, [online], [site visited Nov. 21, 2012]. Available from Internet, <URL: [http://www.gsmarena.com/nokia\\_603-4243.php](http://www.gsmarena.com/nokia_603-4243.php)>.\*

Nokia C7 telephone, announced Sep. 2010, [online], [site visited Nov. 21, 2012]. Available from Internet, <URL: [http://www.gsmarena.com/nokia\\_c7-3394.php](http://www.gsmarena.com/nokia_c7-3394.php)>.\*

Motorola MOTO XT882 telephone, announced May 2011, [online], [site visited Nov. 21, 2012]. Available from Internet, <URL: [http://www.gsmarena.com/motorola\\_moto\\_xt882-3981.php](http://www.gsmarena.com/motorola_moto_xt882-3981.php)>.\*

ZTE N290 telephone, announced 2010, [online], [site visited Nov. 21, 2012]. Available from Internet, <URL: [http://www.gsmarena.com/zte\\_n290-3602.php](http://www.gsmarena.com/zte_n290-3602.php)>.\*

LG Optimus True HD LTE P936 telephone, announced Apr. 2012, [online], [site visited Nov. 21, 2012]. Available from Internet, <URL: [http://www.gsmarena.com/lg\\_optimus\\_true\\_hd\\_lte\\_p936-4717.php](http://www.gsmarena.com/lg_optimus_true_hd_lte_p936-4717.php)>.\*

Nokia N9 by Nokia Corporation, 1 full page of color photograph, disclosed on or about Jun. 2011.

Nokia Lumia 800 by Nokia Corporation, 1 full page of color photograph, disclosed on or about Oct. 2011.

Nokia N8 by Nokia Corporation, 1 full page of color photograph, disclosed on or about Apr. 2011.

Nokia 700 by Nokia Corporation, 1 full page of color photograph, disclosed on or about Aug. 2011.

Nokia C5-03 by Nokia Corporation, 1 full page of color photograph, disclosed on or about Oct. 2010.

Nokia 500 by Nokia Corporation, 1 full page of color photograph, disclosed on or about Aug. 2011.

Nokia E7 by Nokia Corporation, 1 full page of color photograph, disclosed on or about Sep. 2010.

Nokia N900 by Nokia Corporation, 1 full page of color photograph, disclosed on or about Aug. 2009.

Nokia C6-01 by Nokia Corporation, 1 full page of color photograph, disclosed on or about Sep. 2010.

Nokia X6 by Nokia Corporation, 1 full page of color photograph, disclosed on or about Sep. 2009.

Nokia 603 by Nokia Corporation, 1 full page of color photograph, disclosed on or about Oct. 2011.

Nokia C5-06 by Nokia Corporation, 1 full page of color photograph, disclosed on or about Oct. 2011.

Nokia 5250 by Nokia Corporation, 1 full page of color photograph, disclosed on or about Aug. 2010.

\* cited by examiner

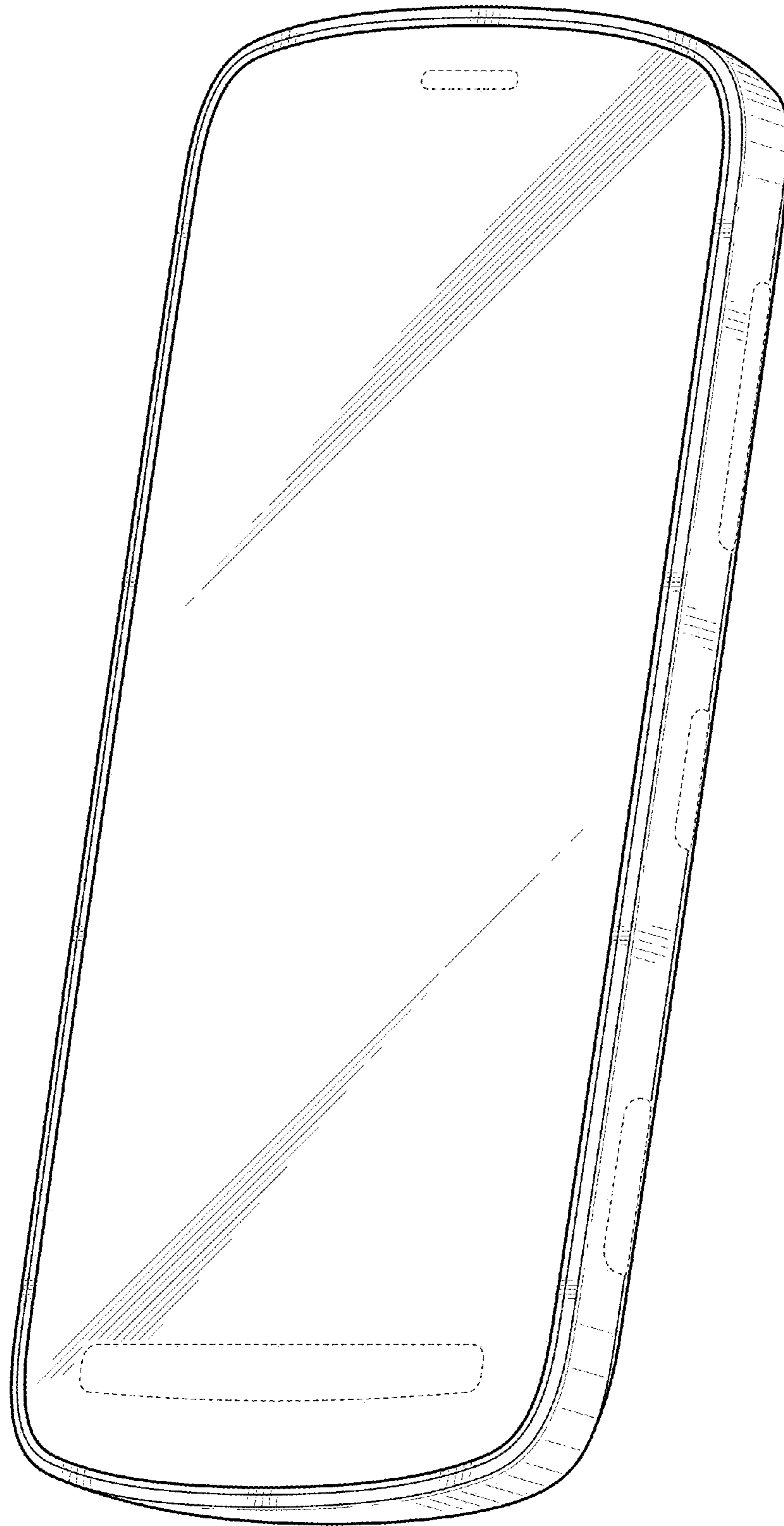

FIG. 1

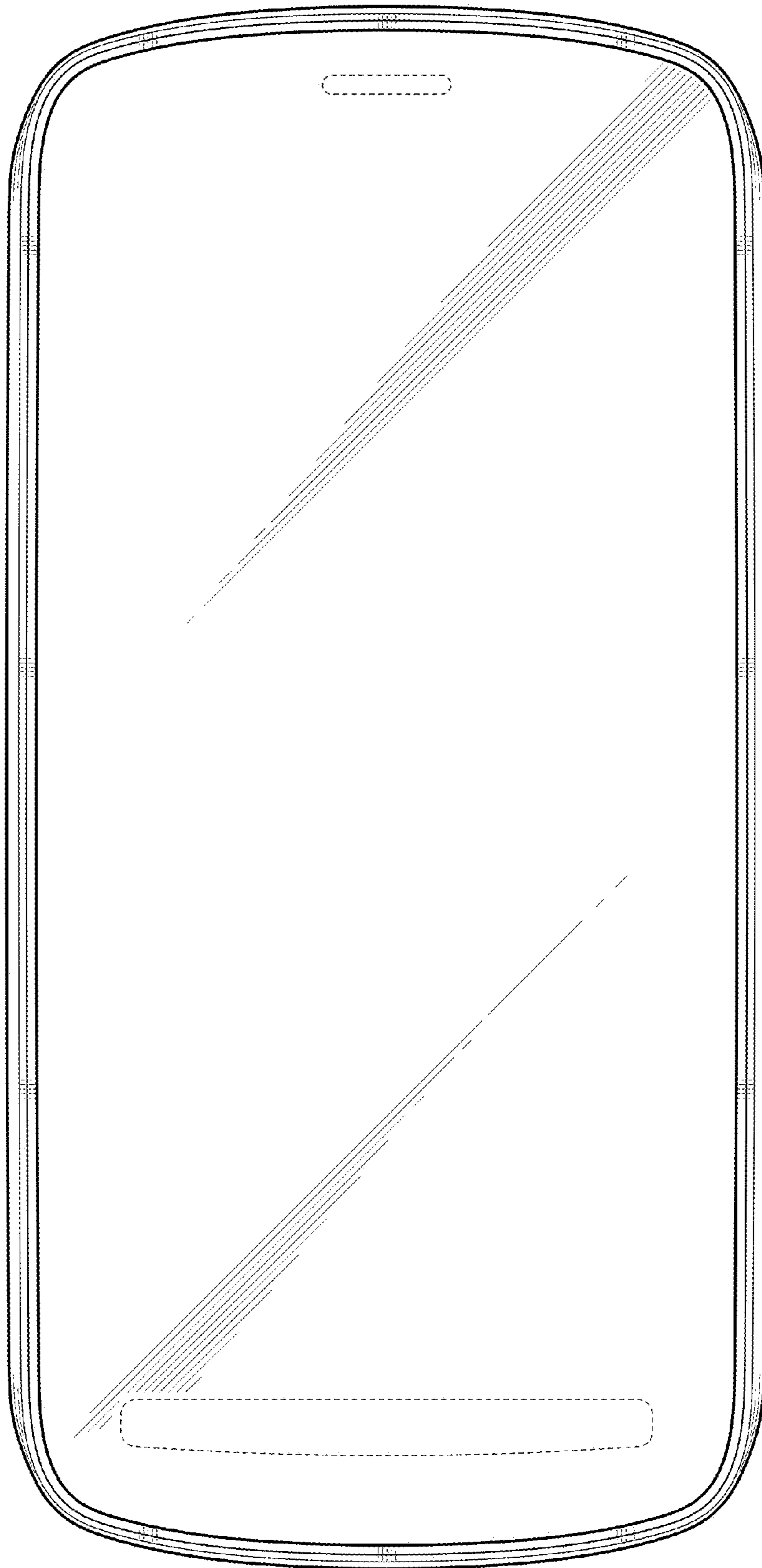

FIG. 2

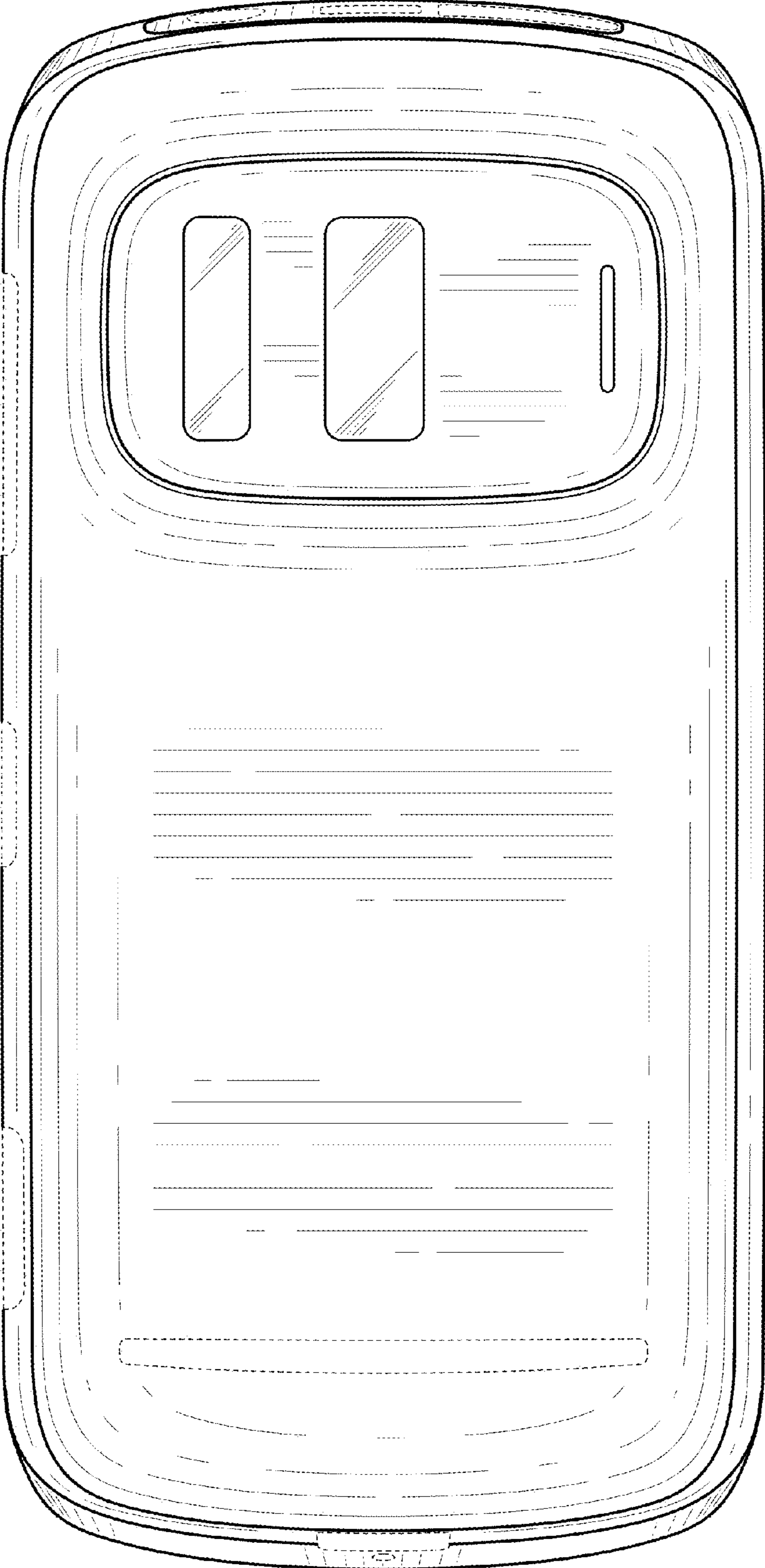

FIG. 3

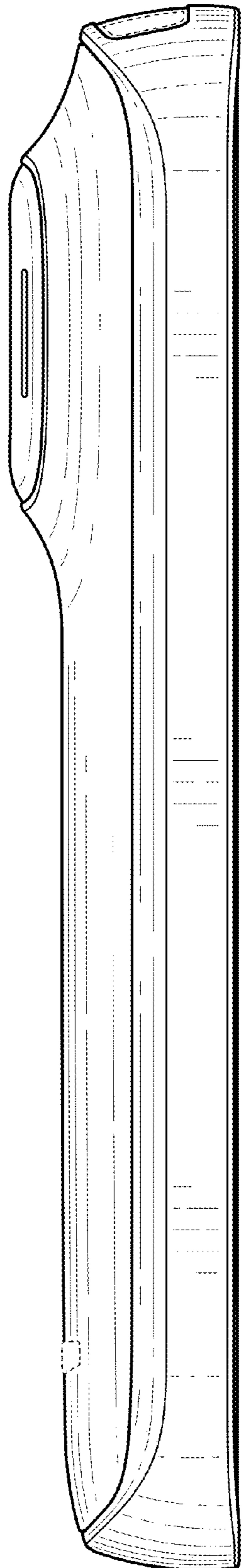

FIG. 4

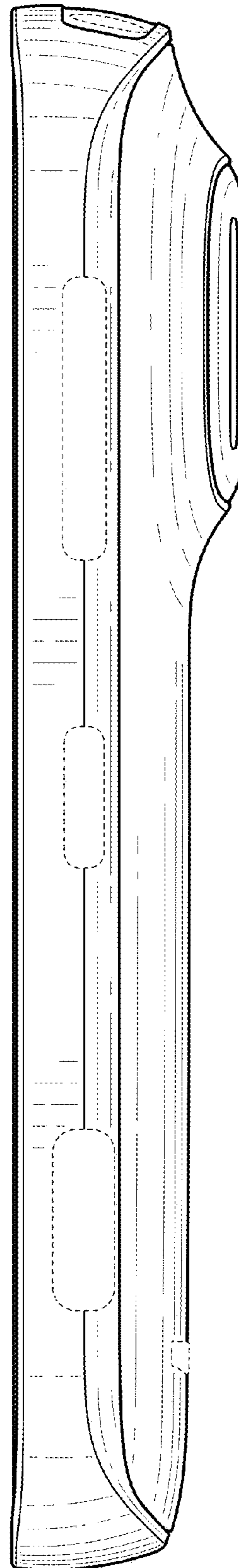

FIG. 5

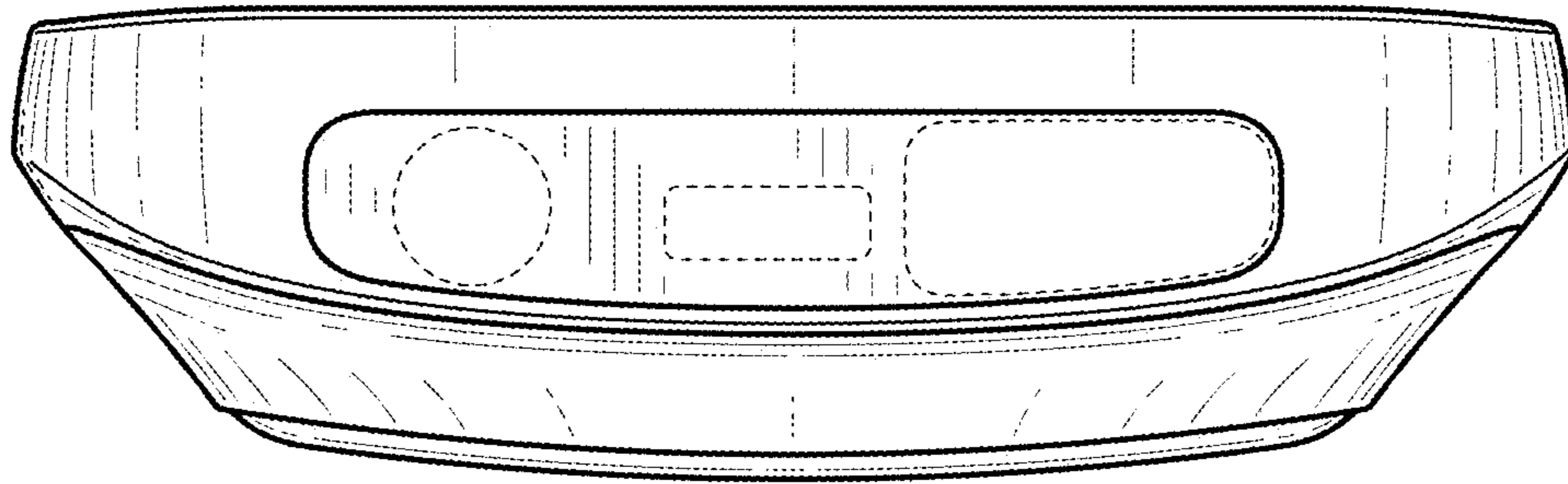

FIG. 6

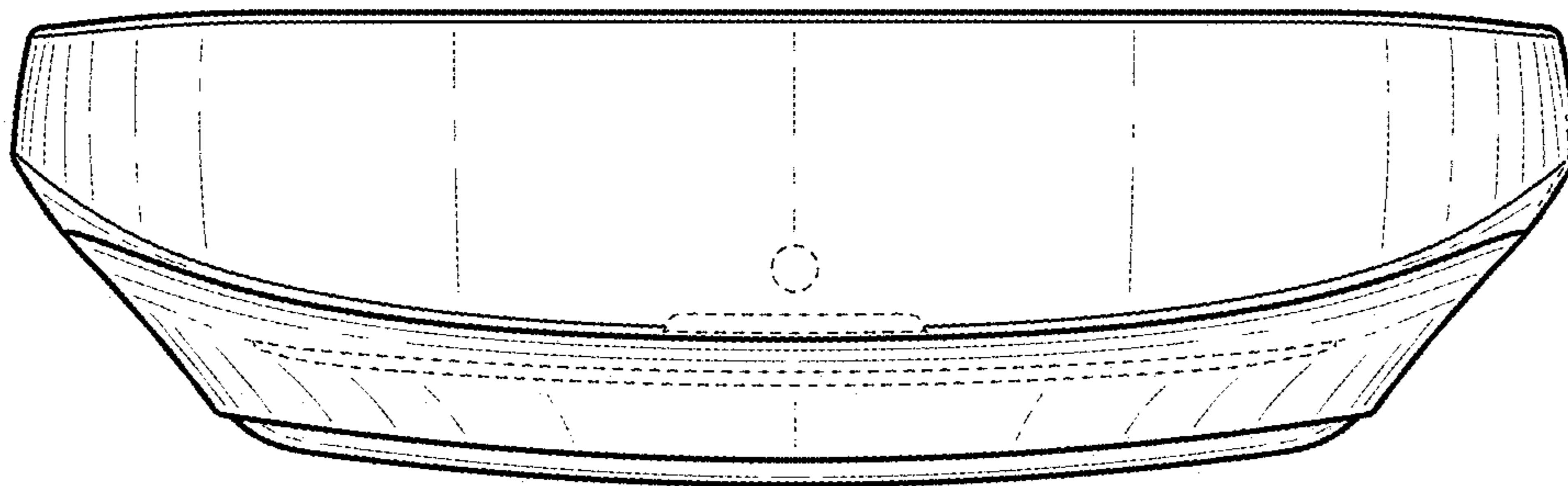

FIG. 7