



US00D680836S

(12) **United States Design Patent**
Bhasin

(10) **Patent No.:** **US D680,836 S**

(45) **Date of Patent:** **** Apr. 30, 2013**

(54) **SCISSORS**

(75) Inventor: **Hanuman Prasad Bhasin**, Suita (JP)

(73) Assignee: **B.H.P. Industries Co., Ltd.**, Suita-shi (JP)

(**) Term: **14 Years**

(21) Appl. No.: **29/405,526**

(22) Filed: **Nov. 3, 2011**

(30) **Foreign Application Priority Data**

Jun. 13, 2011 (JP) 2011-013352
Aug. 23, 2011 (JP) 2011-019039

(51) **LOC (9) Cl.** **08-03**

(52) **U.S. Cl.**
USPC **D8/57**

(58) **Field of Classification Search** D8/4, 5,
D8/51-58, 105, 107; D21/532; D27/195;
D28/44, 57; D7/693; D24/148; 30/131,
30/195, 229, 194, 230-235, 268, 350, 254-258;
7/135, 136

See application file for complete search history.

(56) **References Cited**

U.S. PATENT DOCUMENTS

D243,650 S * 3/1977 Hayashi D8/55
D246,223 S * 11/1977 Hayashi D8/55
D256,215 S * 8/1980 Chen D8/57
D285,166 S * 8/1986 Lee D8/57
D329,792 S * 9/1992 Chen D8/57
D337,248 S * 7/1993 Tanfoglio D8/57
D337,497 S * 7/1993 Rose D8/57

(Continued)

Primary Examiner — Deanna L Fluegeman

(74) *Attorney, Agent, or Firm* — W. F. Fasse

(57) **CLAIM**

The ornamental design for a scissors, as shown and described.

DESCRIPTION

FIG. 1 is a front view of a scissors showing my new design related to the first embodiment;

FIG. 2 is a rear view thereof;

FIG. 3 is a top plan view thereof;

FIG. 4 is a bottom plan view thereof;

FIG. 5 is a left side view thereof;

FIG. 6 is a right side view thereof;

FIG. 7 is an enlarged view taken along the arrowed line 7-7 thereof;

FIG. 8 is an end view of the sectioned part taken along the arrowed line 8-8 thereof;

FIG. 9 is an end view of the sectioned part taken along the arrowed line 9-9 thereof;

FIG. 10 is a perspective view of the enlarged portion of the scissors shown in FIG. 7.

FIG. 11 is a front view thereof showing the opened state;

FIG. 12 is a front view of a scissors according to a second embodiment of my new design;

FIG. 13 is a rear view thereof;

FIG. 14 is a top plan view thereof;

FIG. 15 is a bottom plan view thereof;

FIG. 16 is a left side view thereof;

FIG. 17 is a right side view thereof;

FIG. 18 is an enlarged view taken along the arrowed line 18-18 thereof;

FIG. 19 is an end view of the sectioned part taken along the arrowed line 19-19 thereof;

FIG. 20 is an end view of the sectioned part taken along the arrowed line 20-20 thereof;

FIG. 21 is an end view of the sectioned part taken along the arrowed line 21-21 thereof;

FIG. 22 is a perspective view of the enlarged portion of the scissors shown in FIG. 18.

FIG. 23 is a front view thereof showing the opened state; and,

FIG. 24 is a front view thereof showing the exploded state.

1 Claim, 13 Drawing Sheets

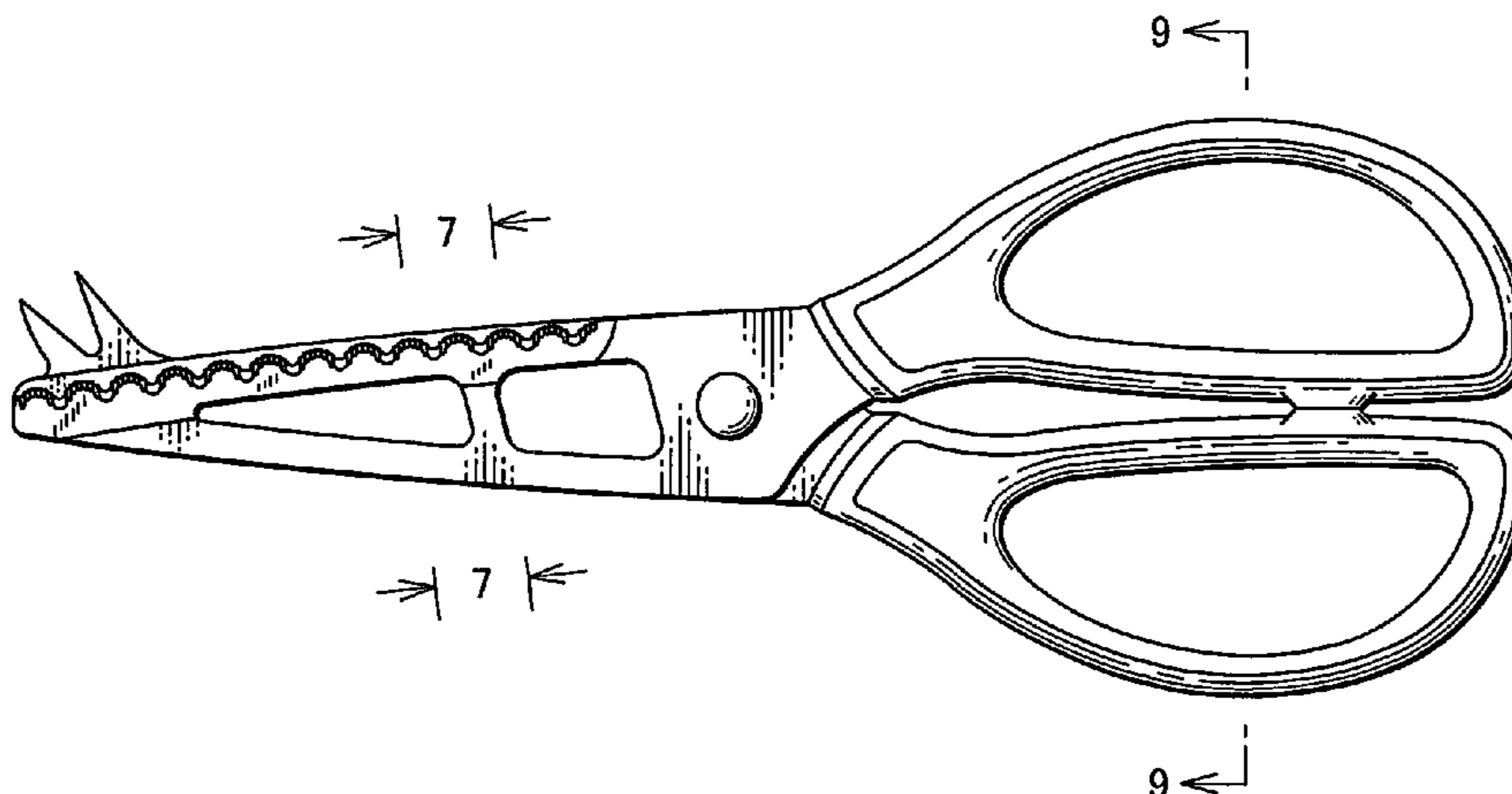

US D680,836 S

Page 2

U.S. PATENT DOCUMENTS

D358,748 S *	5/1995	Ramsey et al.	D8/57	D523,307 S *	6/2006	Chang	D8/57
D398,502 S *	9/1998	Jacquet	D8/57	D557,096 S *	12/2007	Wu	D8/57
D431,436 S *	10/2000	Gstalder	D8/57	7,458,160 B2 *	12/2008	Escobar et al.	30/232
D483,635 S *	12/2003	Silver et al.	D8/57	D651,494 S *	1/2012	Bhasin	D8/57
D502,077 S *	2/2005	Hasegawa	D8/107	D651,496 S *	1/2012	Bhasin	D8/57

* cited by examiner

FIG.1

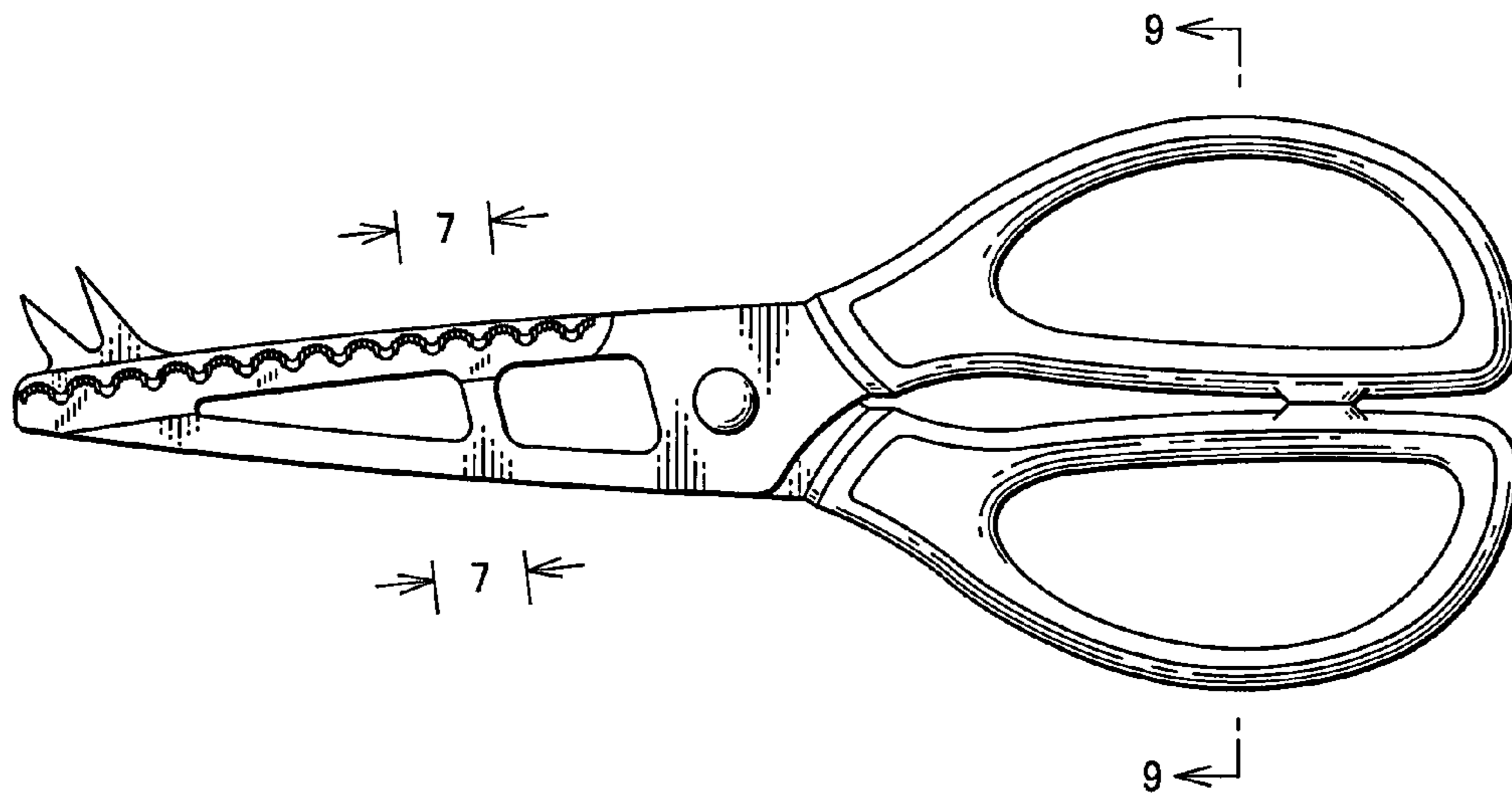

FIG.2

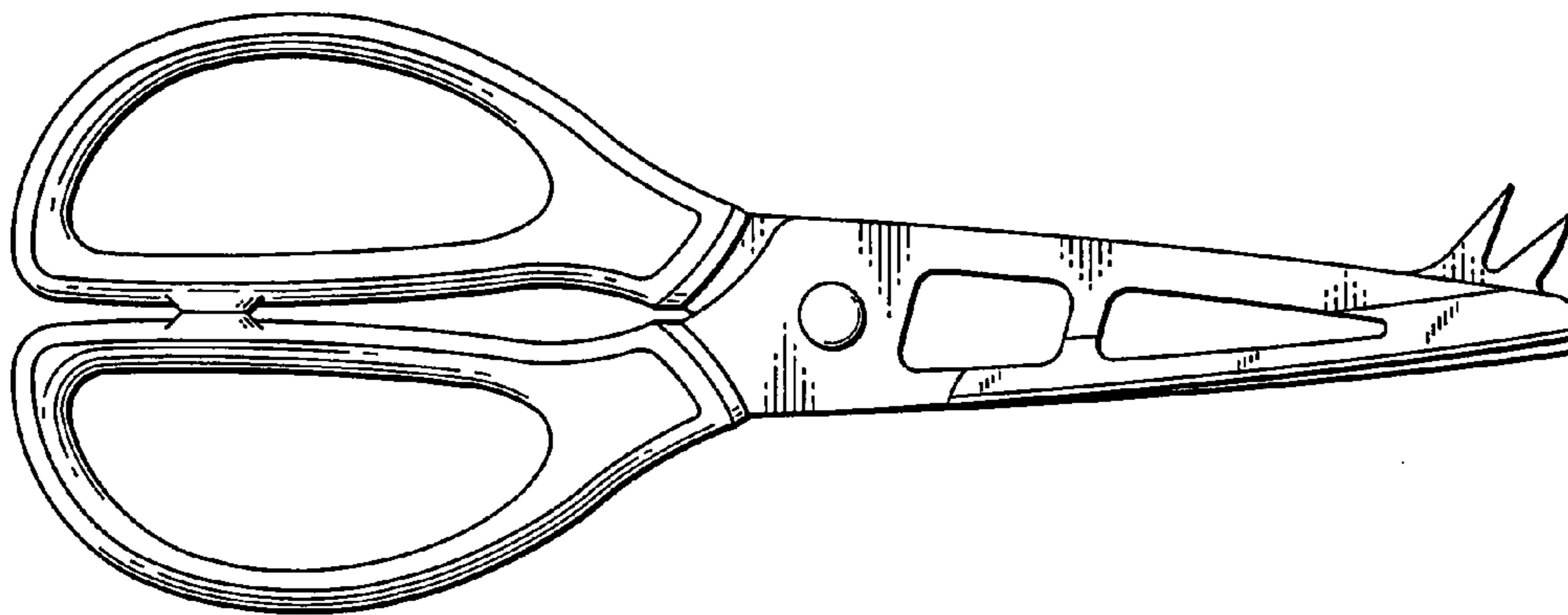

FIG.3

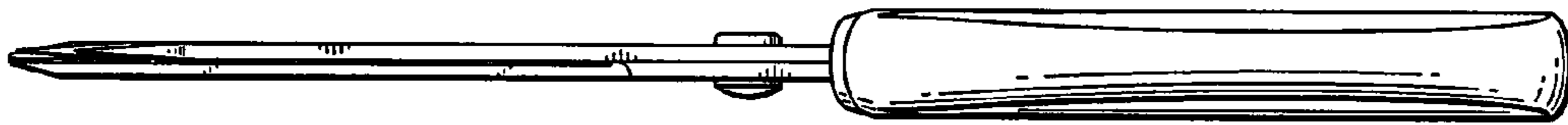

FIG.4

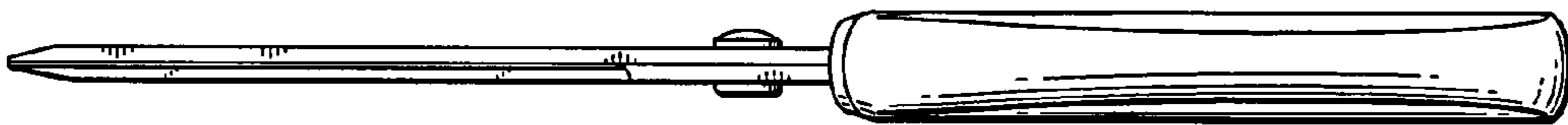

FIG.5



FIG.6



FIG.7

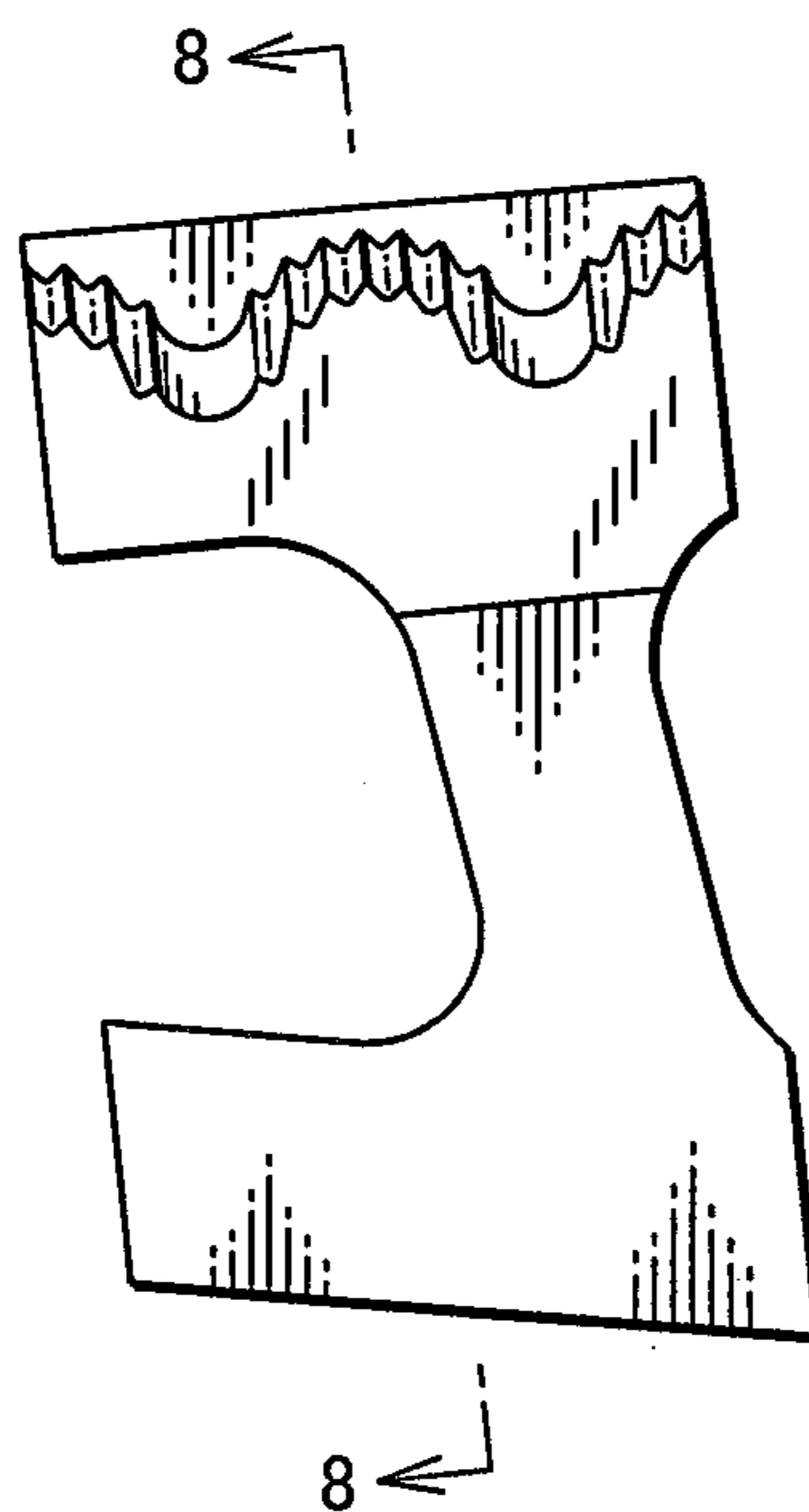

FIG.8

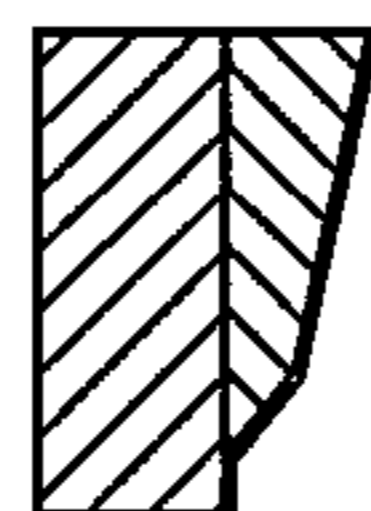
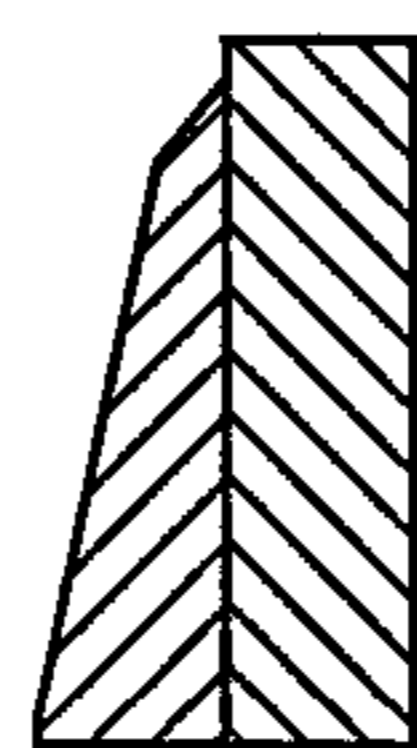

FIG.9



FIG.10

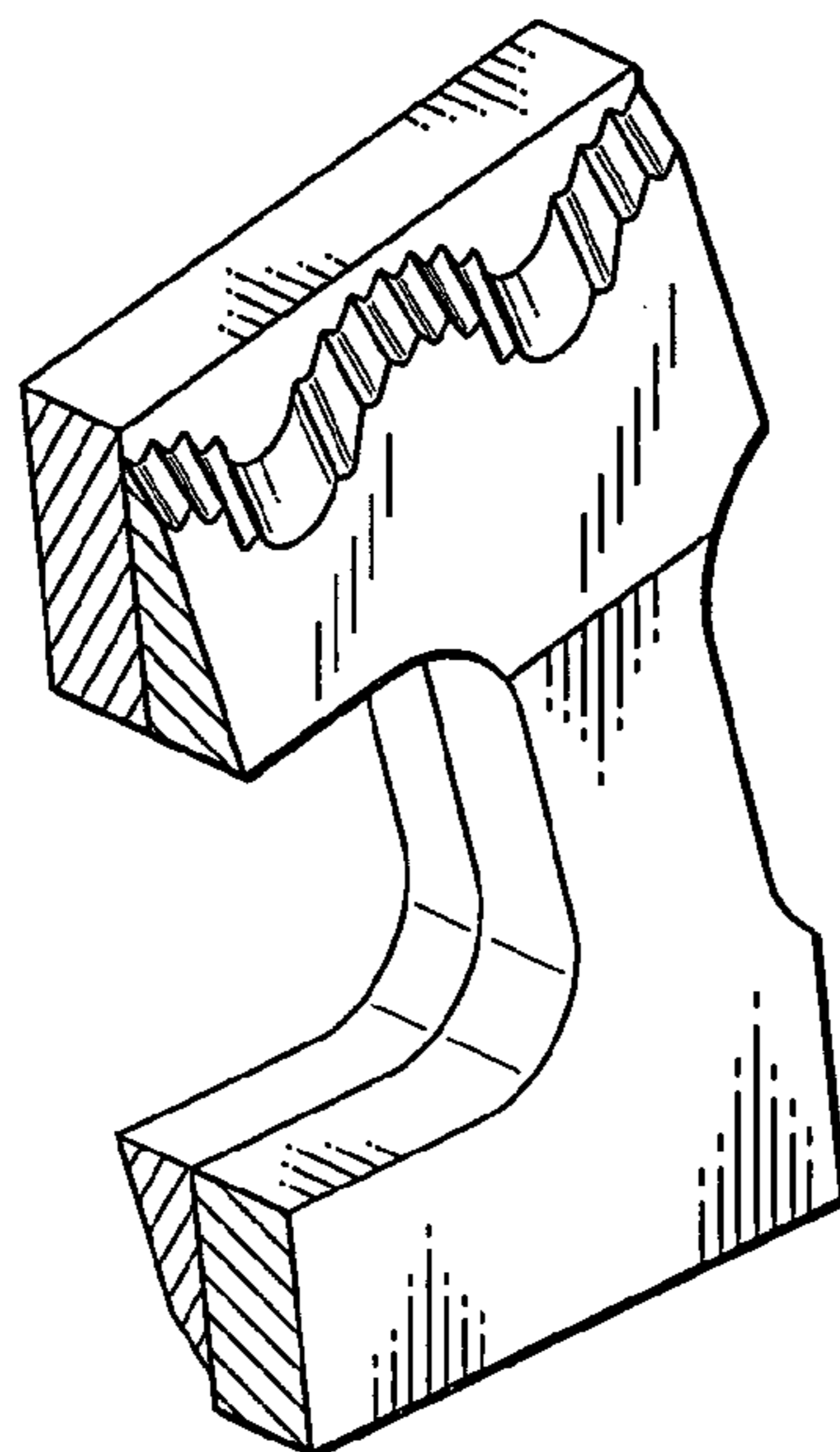

FIG.11

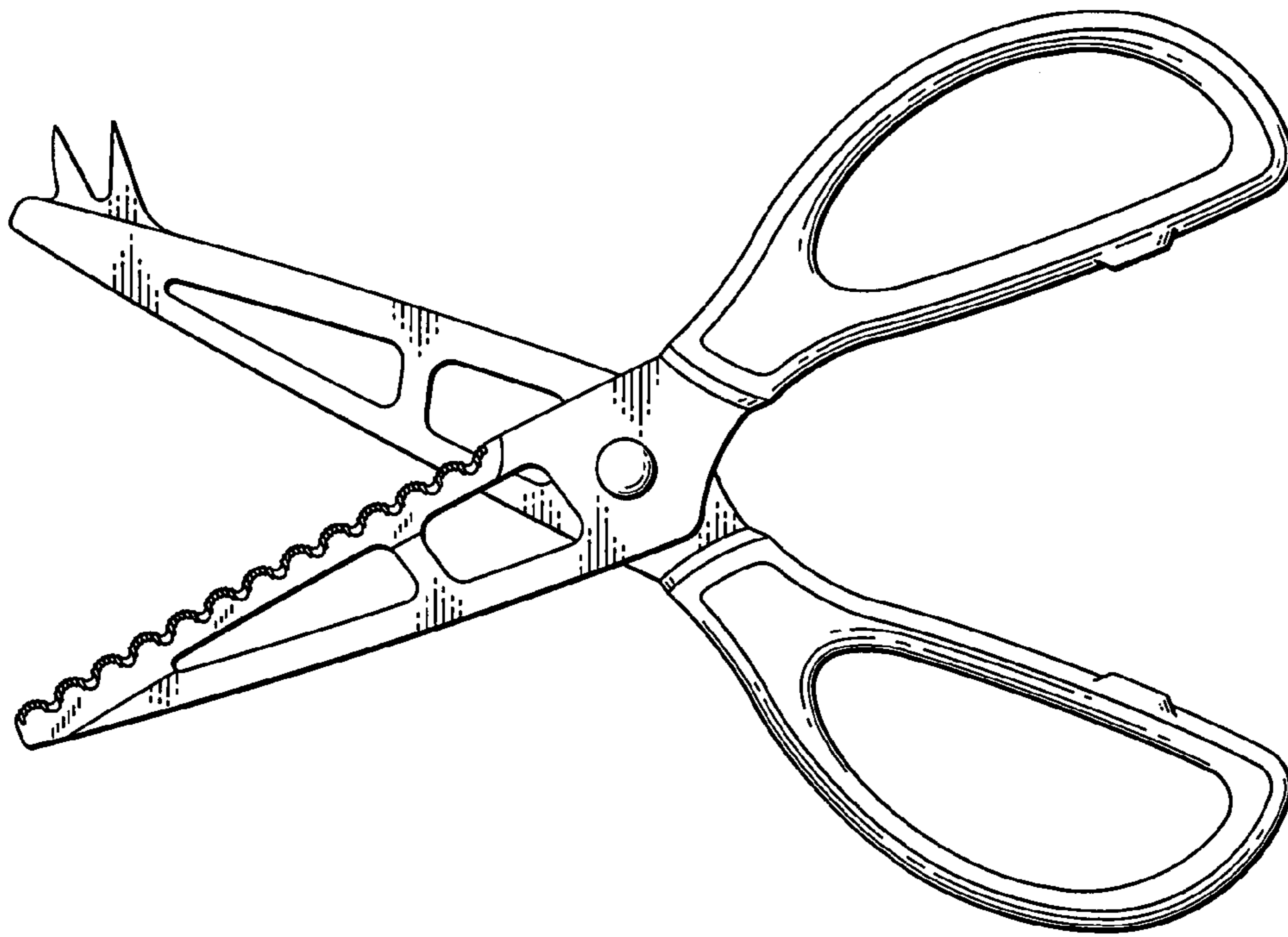

FIG.12

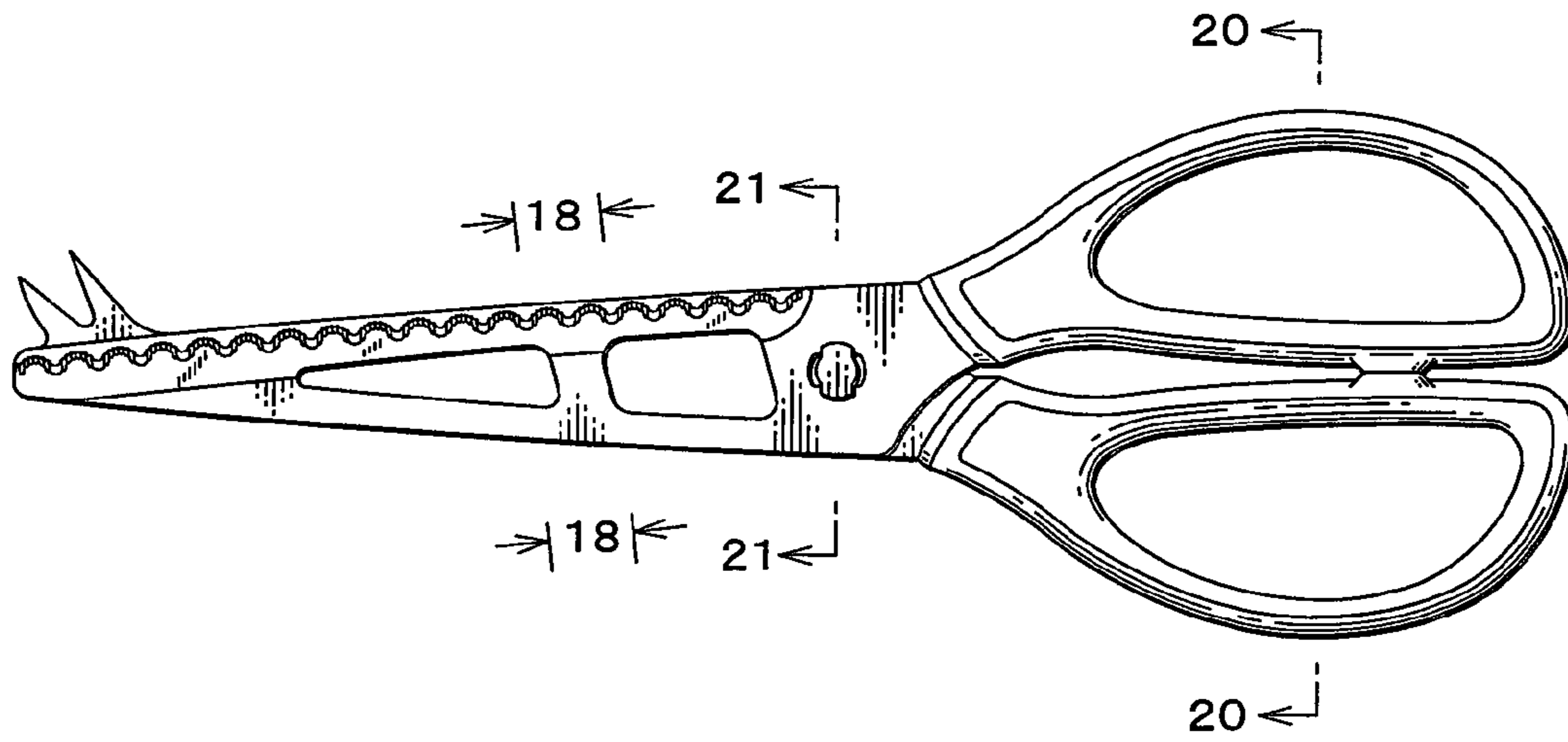

FIG.13

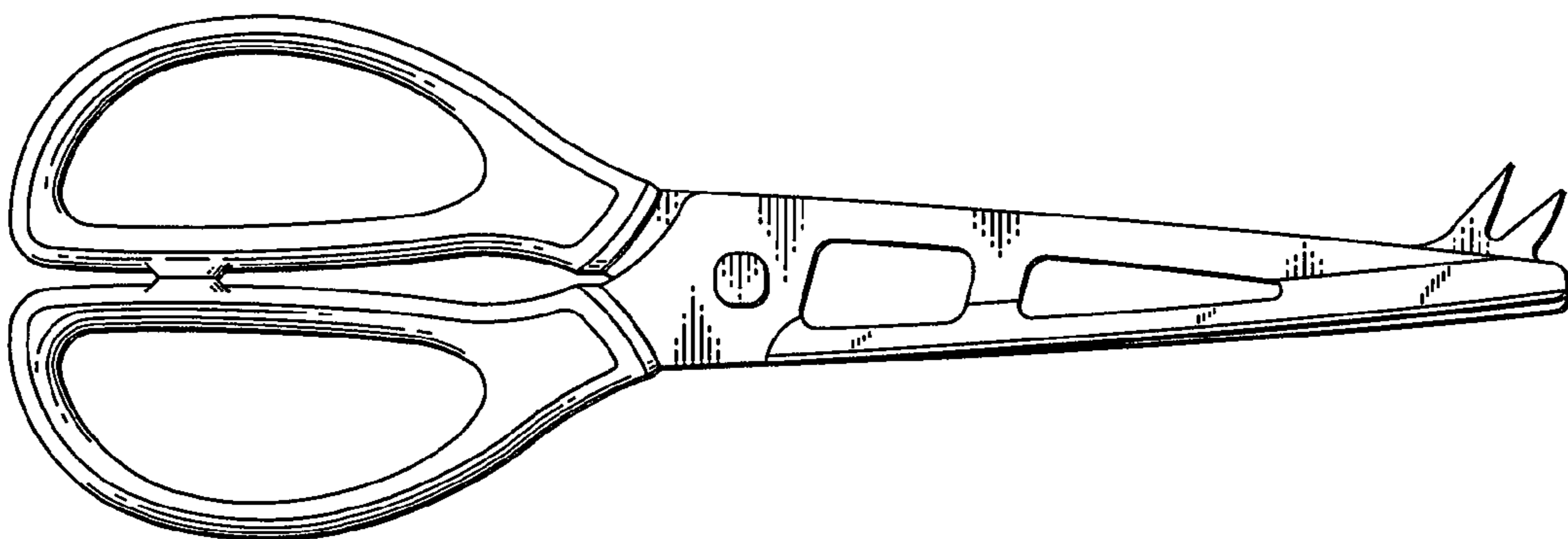

FIG. 14

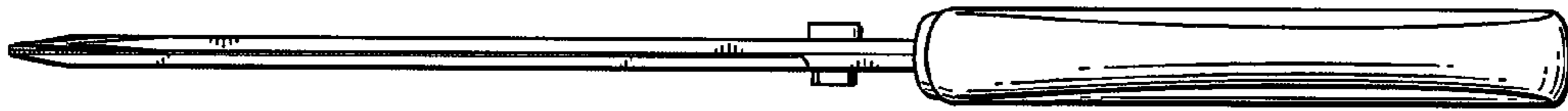

FIG. 15

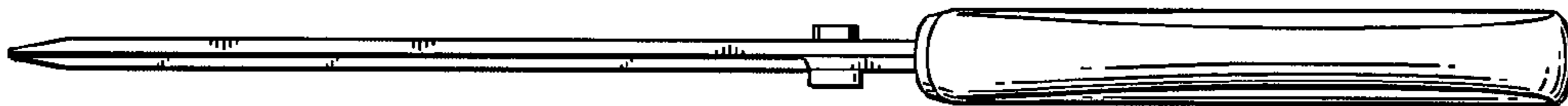

FIG. 16



FIG. 17



FIG. 18

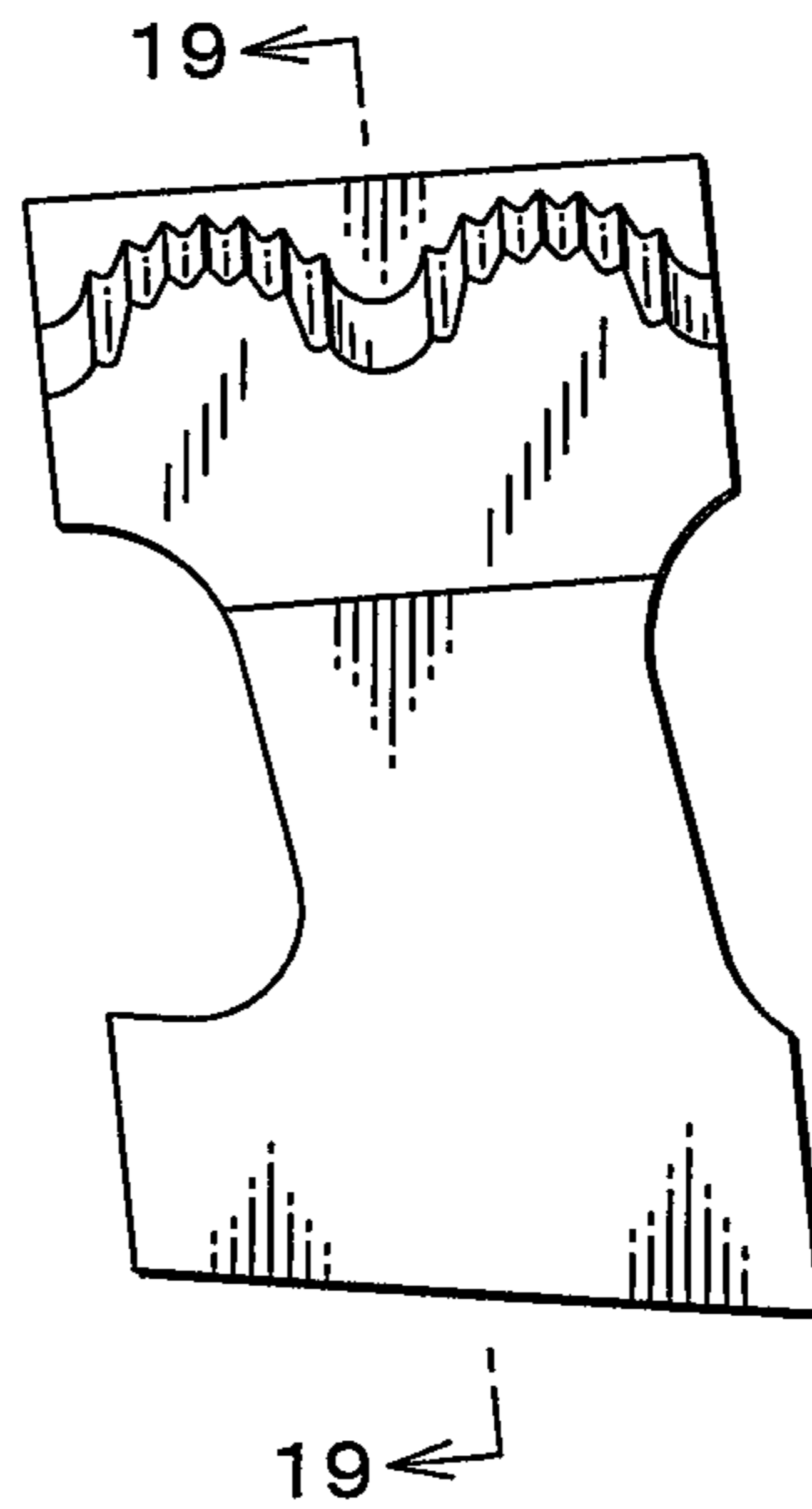

FIG. 19

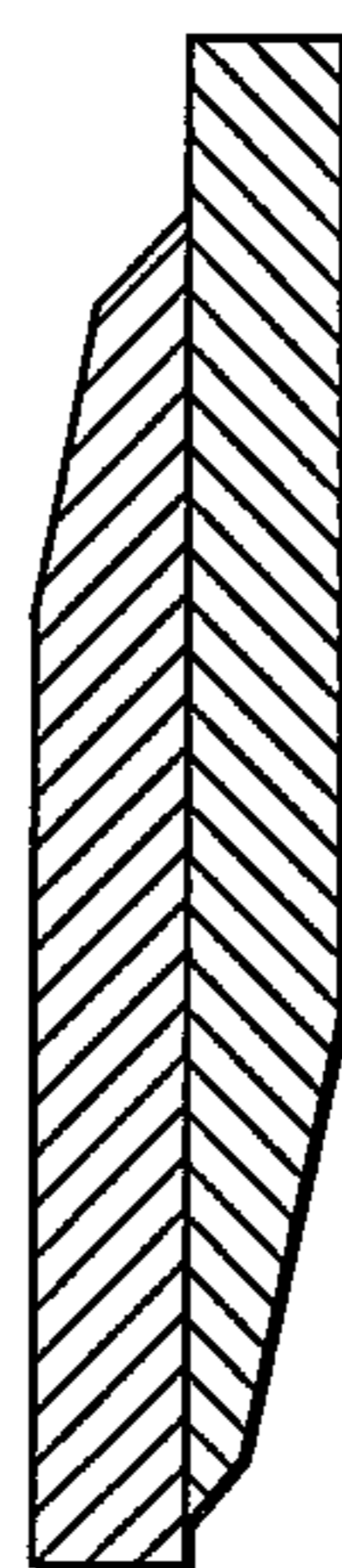

FIG.20



FIG.21



FIG.22

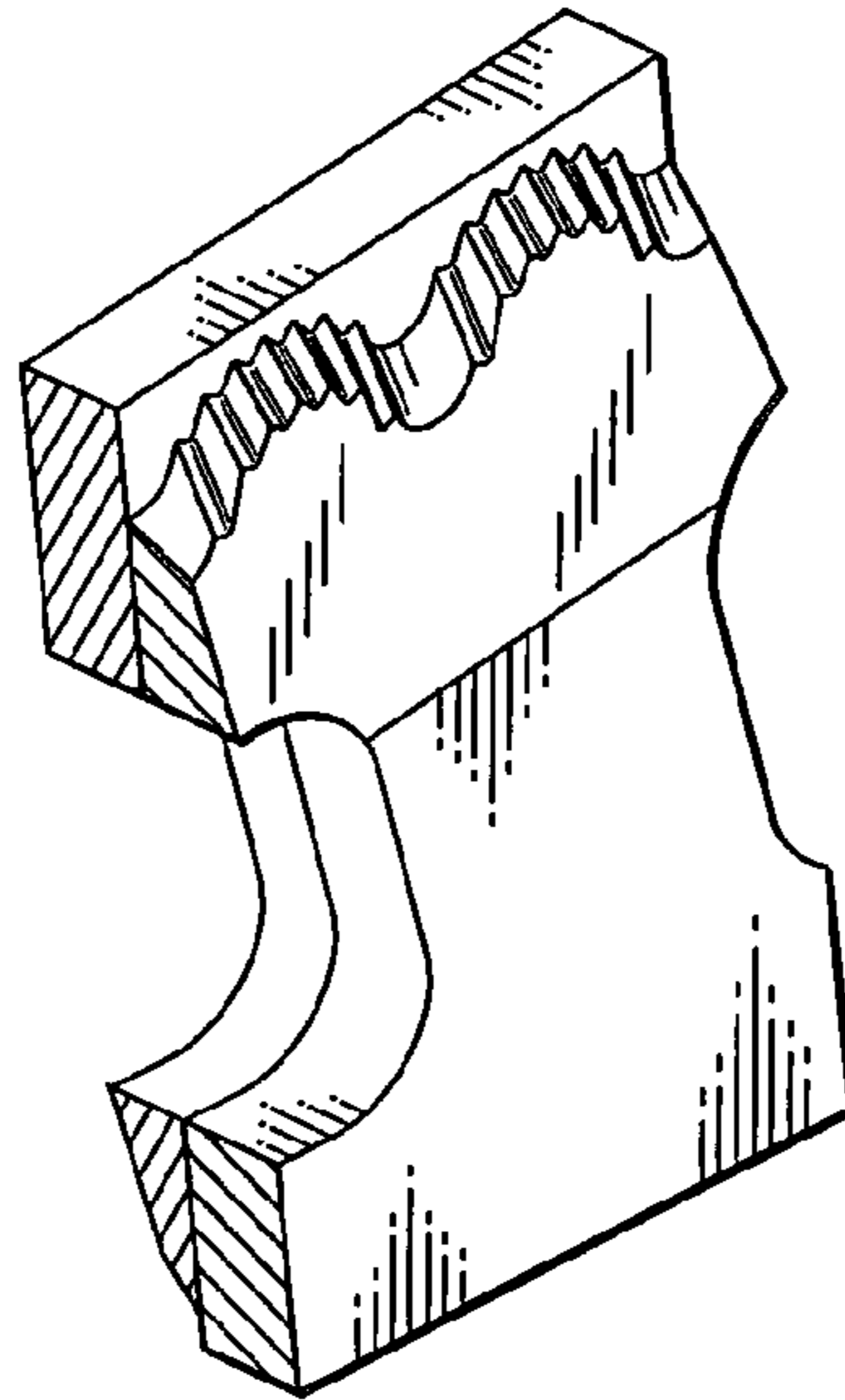

FIG.23

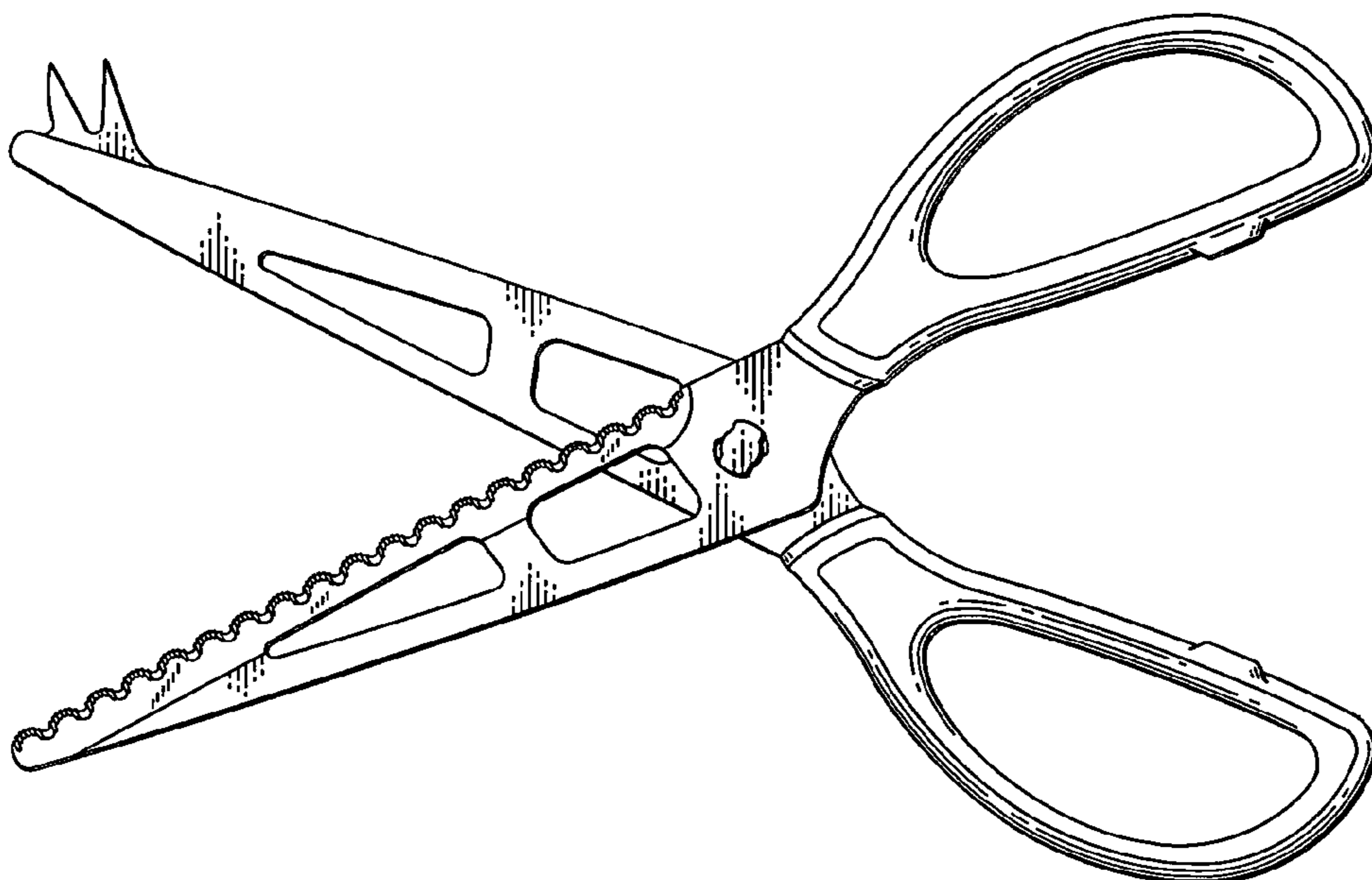

FIG.24

