



US00D680775S

(12) **United States Design Patent**
Xin et al.

(10) **Patent No.:** **US D680,775 S**

(45) **Date of Patent:** **** Apr. 30, 2013**

(54) **SHOE RACK**

(75) Inventors: **Kevin Xin**, Markham (CA); **Melody Lee**, Markham (CA)

(73) Assignee: **Merry Products Corporation**, Markham, Ontario (CA)

(**) Term: **14 Years**

(21) Appl. No.: **29/414,115**

(22) Filed: **Feb. 24, 2012**

(51) **LOC (9) Cl.** **06-06**

(52) **U.S. Cl.**

USPC **D6/478**

(58) **Field of Classification Search** D6/396–397, D6/477–479, 515, 570–573, 552; 108/1, 108/3, 59–60, 93–94, 96, 14.11, 14.17; 211/90.01, 211/90.04, 36, 42, 50, 70, 115, 144, 163; 312/163, 9.52–9.54

See application file for complete search history.

(56) **References Cited**

U.S. PATENT DOCUMENTS

D256,307 S *	8/1980	Frank	D6/436
D291,166 S *	8/1987	Morris	D6/476
D318,194 S *	7/1991	Terrell et al.	D6/414
D337,673 S *	7/1993	Goetz	D6/473
D424,320 S *	5/2000	Klein et al.	D6/411
D458,772 S *	6/2002	Klein et al.	D6/462
D475,554 S *	6/2003	Ming-Shiue	D6/449
D588,648 S *	3/2009	Kanbar	D19/89

D601,368 S *	10/2009	Calco	D6/478
D608,798 S *	1/2010	Linder et al.	D15/81
D644,039 S *	8/2011	Naples et al.	D6/449
D647,731 S *	11/2011	Kotz et al.	D6/492

* cited by examiner

Primary Examiner — Kelley Donnelly

(74) *Attorney, Agent, or Firm* — Harness, Dickey & Pierce, P.L.C.

(57) **CLAIM**

The ornamental design for a shoe rack, as shown and described.

DESCRIPTION

FIG. 1 is a perspective view of a shoe rack in accordance with a first embodiment of my design; FIG. 2 is a top view thereof; FIG. 3 is a front view thereof; FIG. 4 is a rear view thereof; FIG. 5 is a left side view thereof; FIG. 6 is a right side view thereof; and, FIG. 7 is a perspective view of a shoe rack in accordance with a second embodiment of my design, it being understood that the second embodiment is a mirror image of the first embodiment.

In the drawings, the broken lines are for illustrative purposes only and form no part of the claimed design. No claim is made to features of the bottom side.

1 Claim, 7 Drawing Sheets

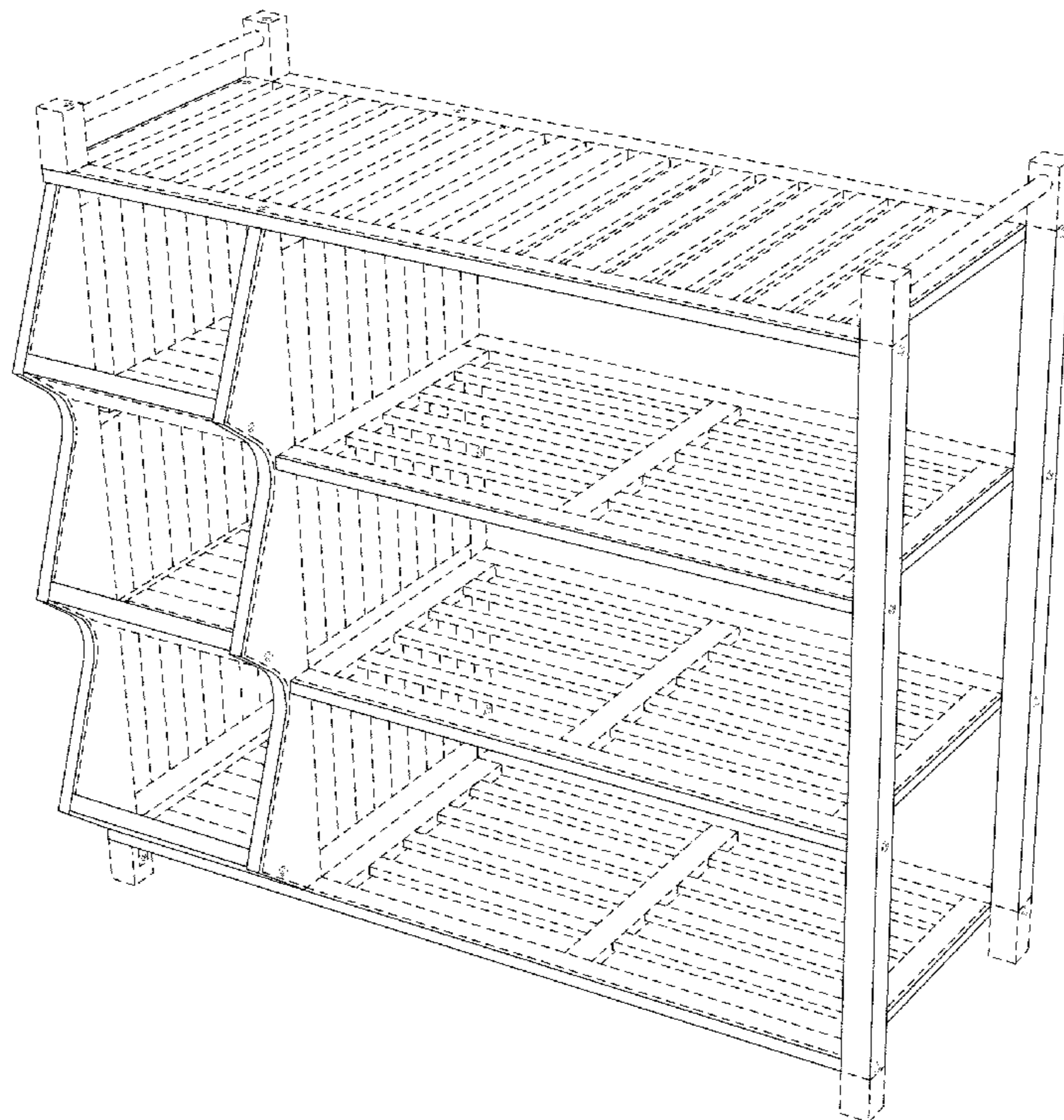

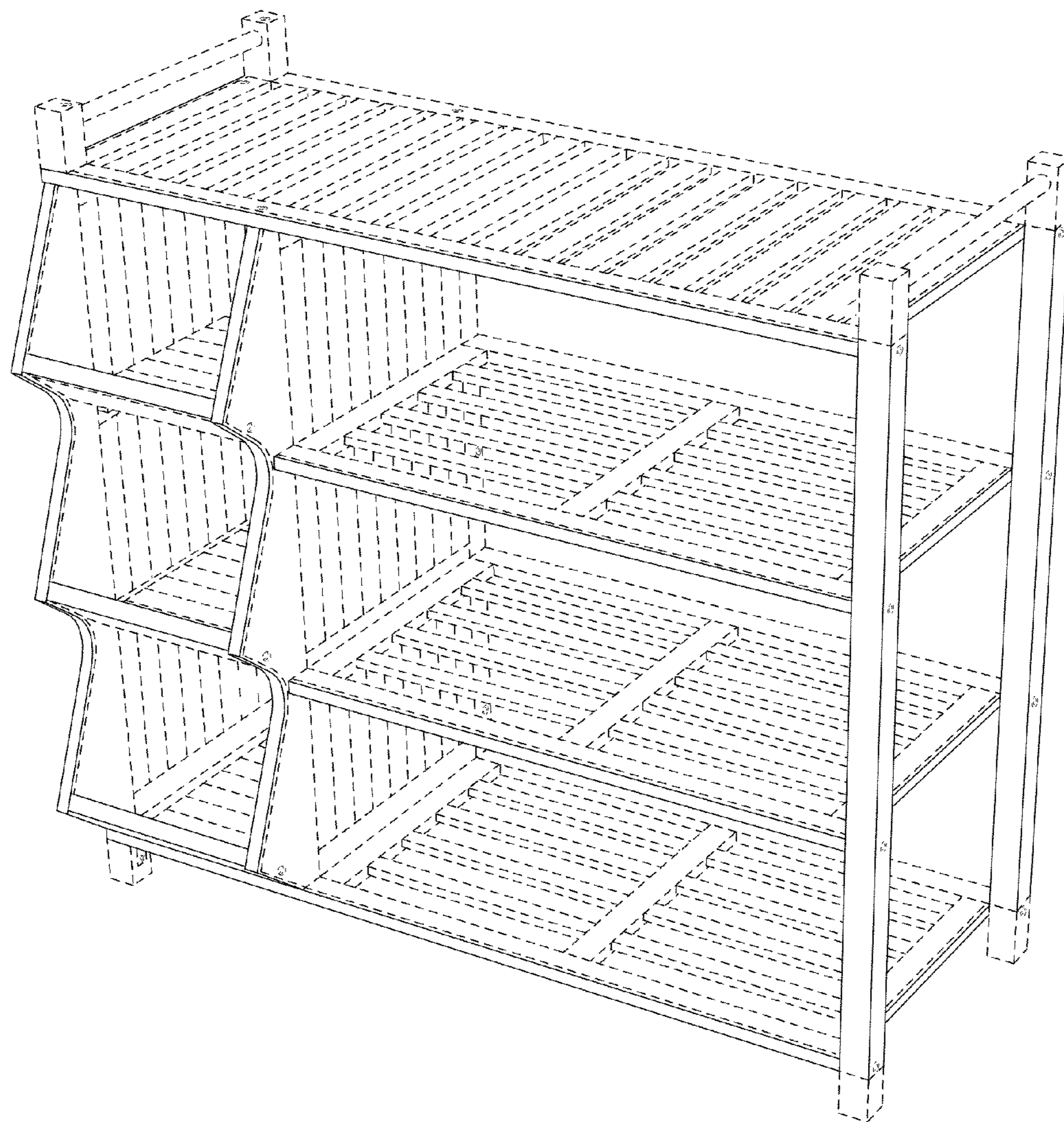

Fig. 1

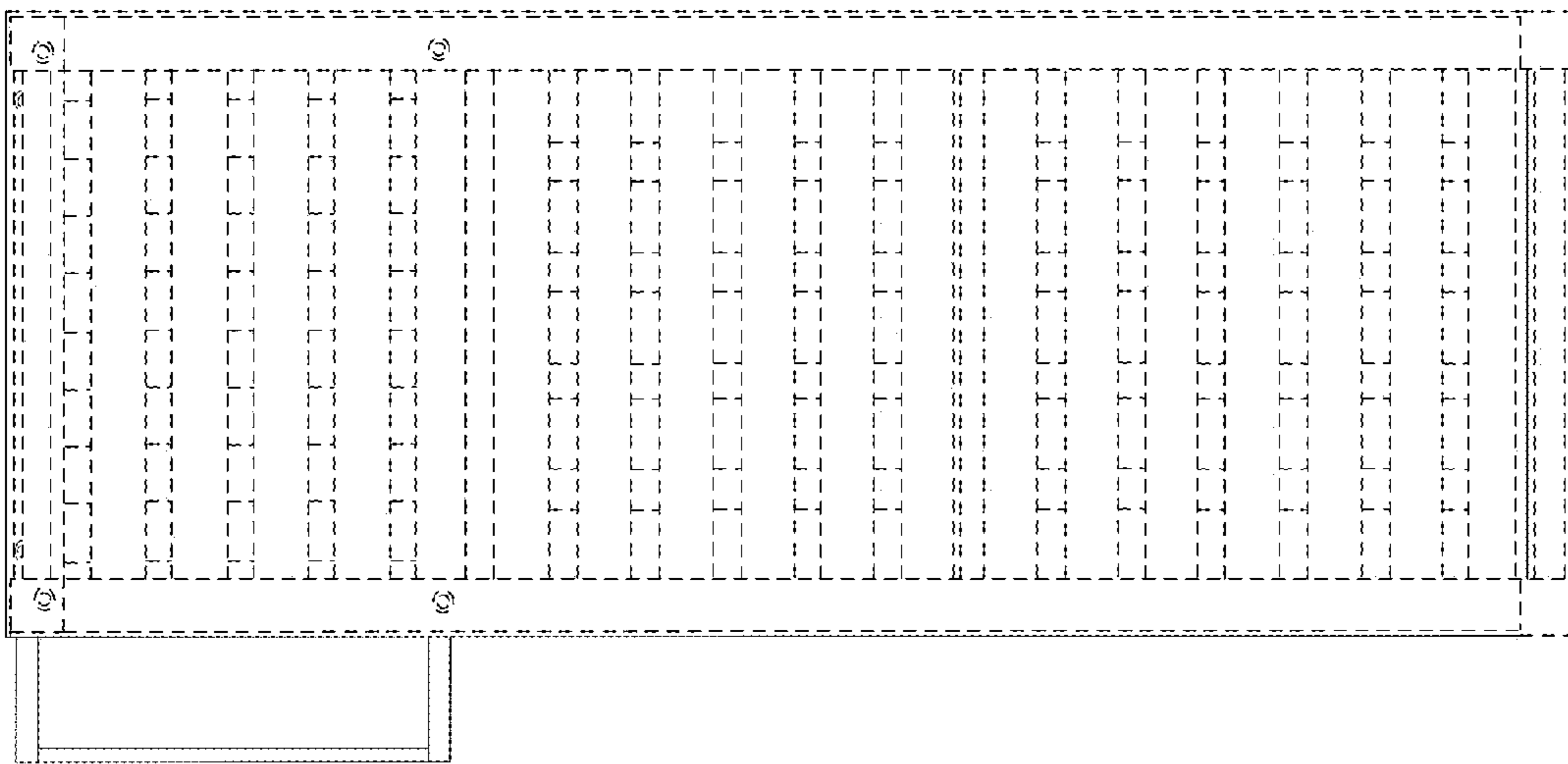

Fig. 2

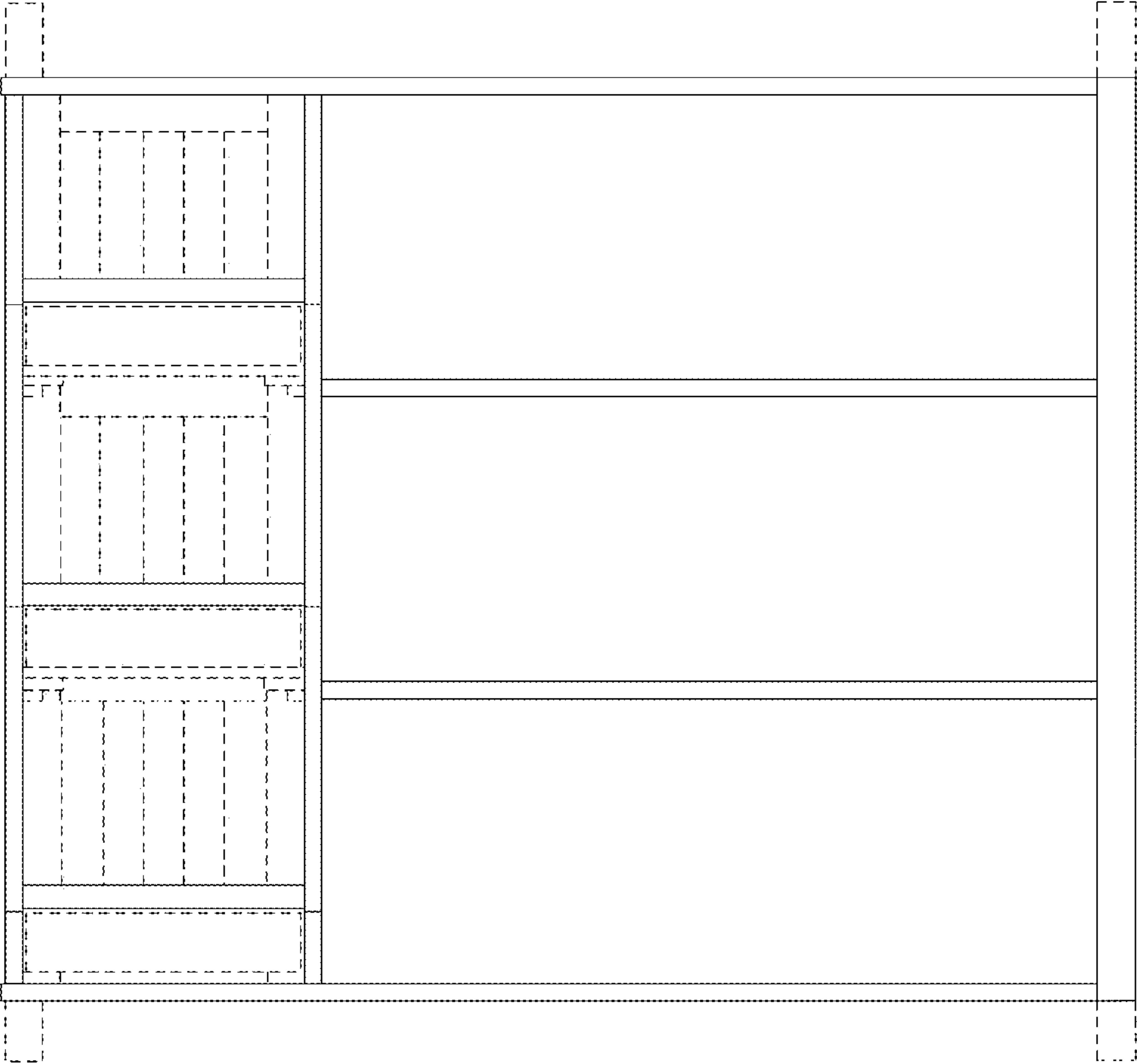

Fig. 3

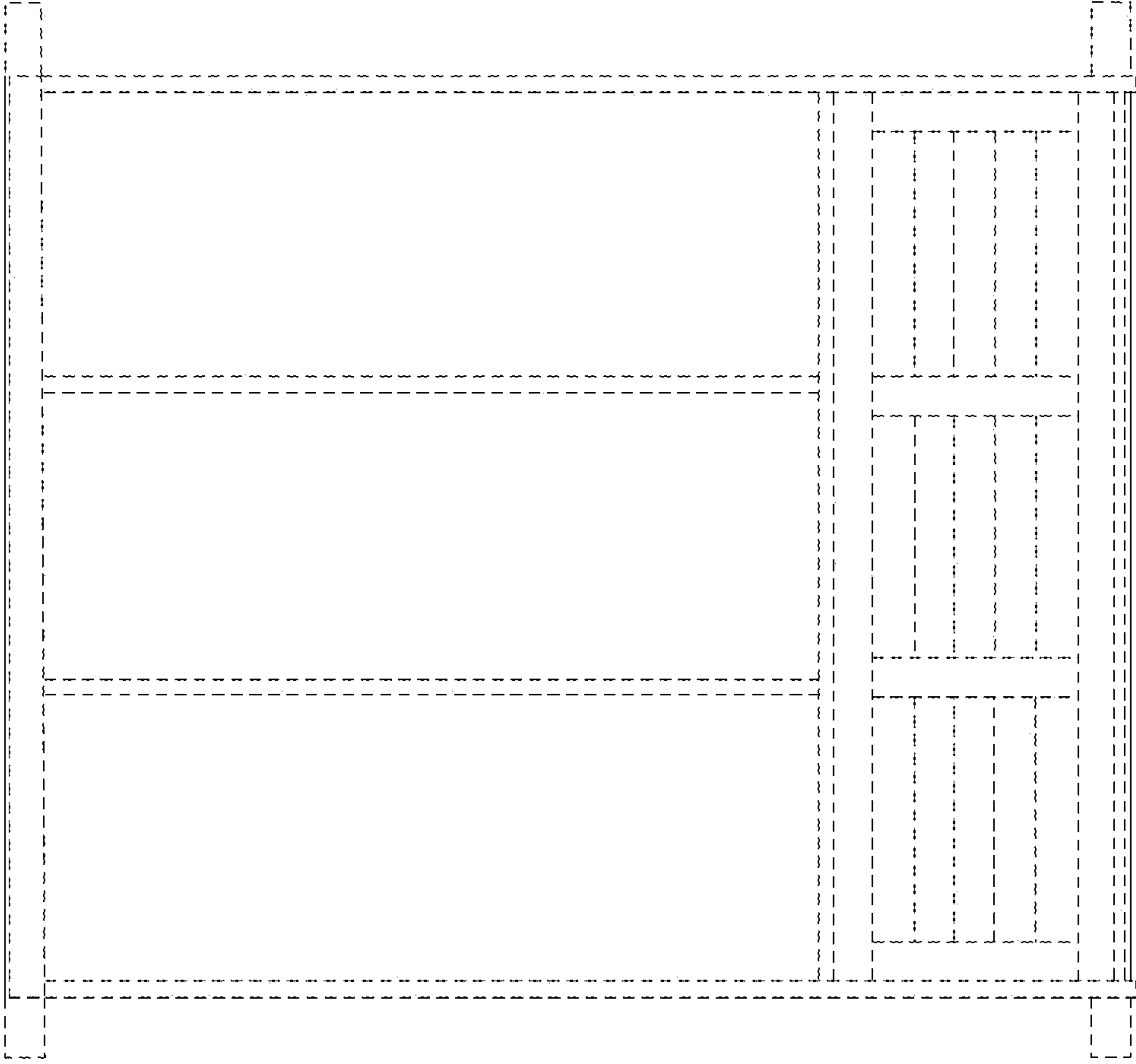

Fig. 4

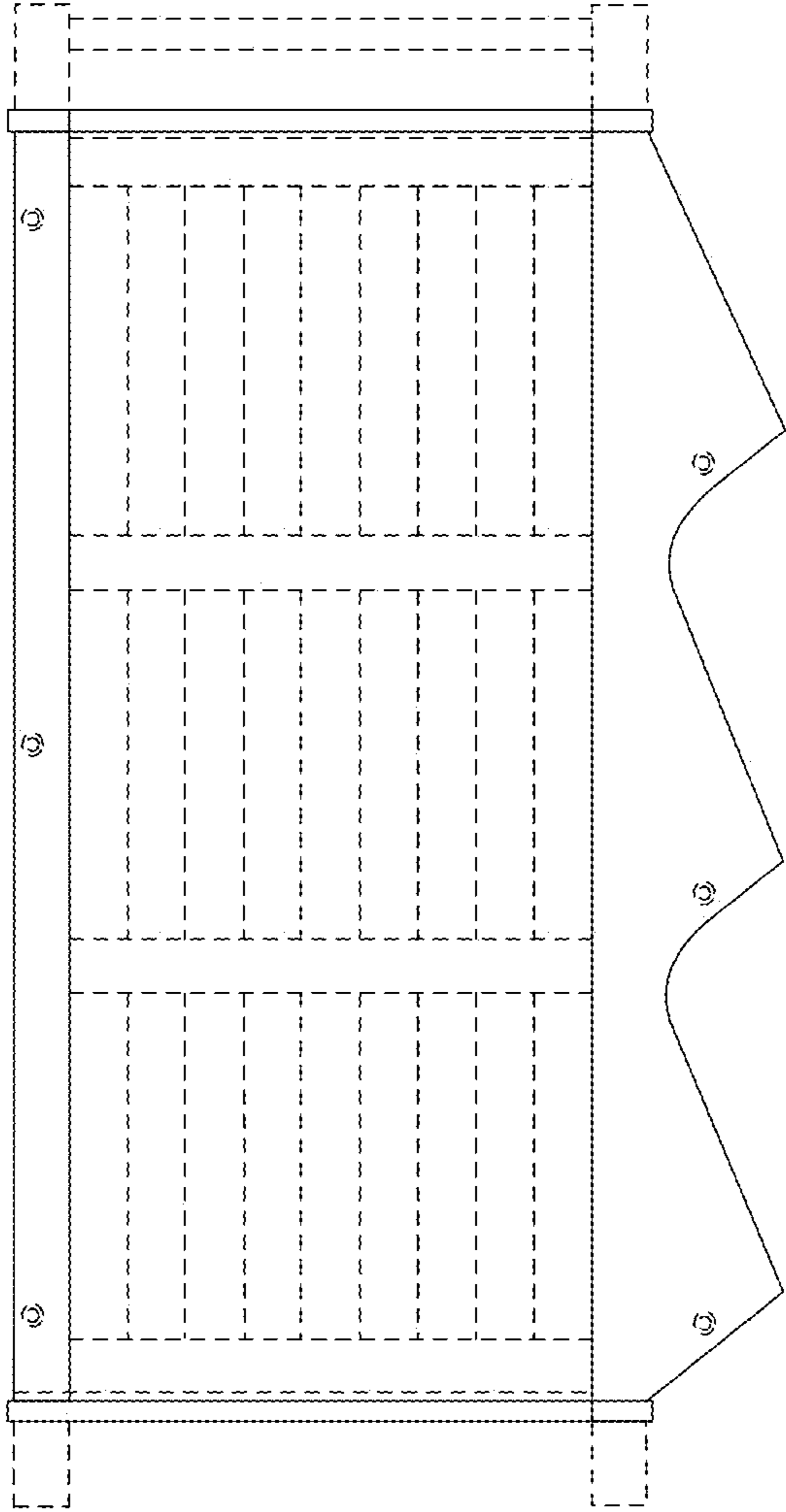

Fig. 5

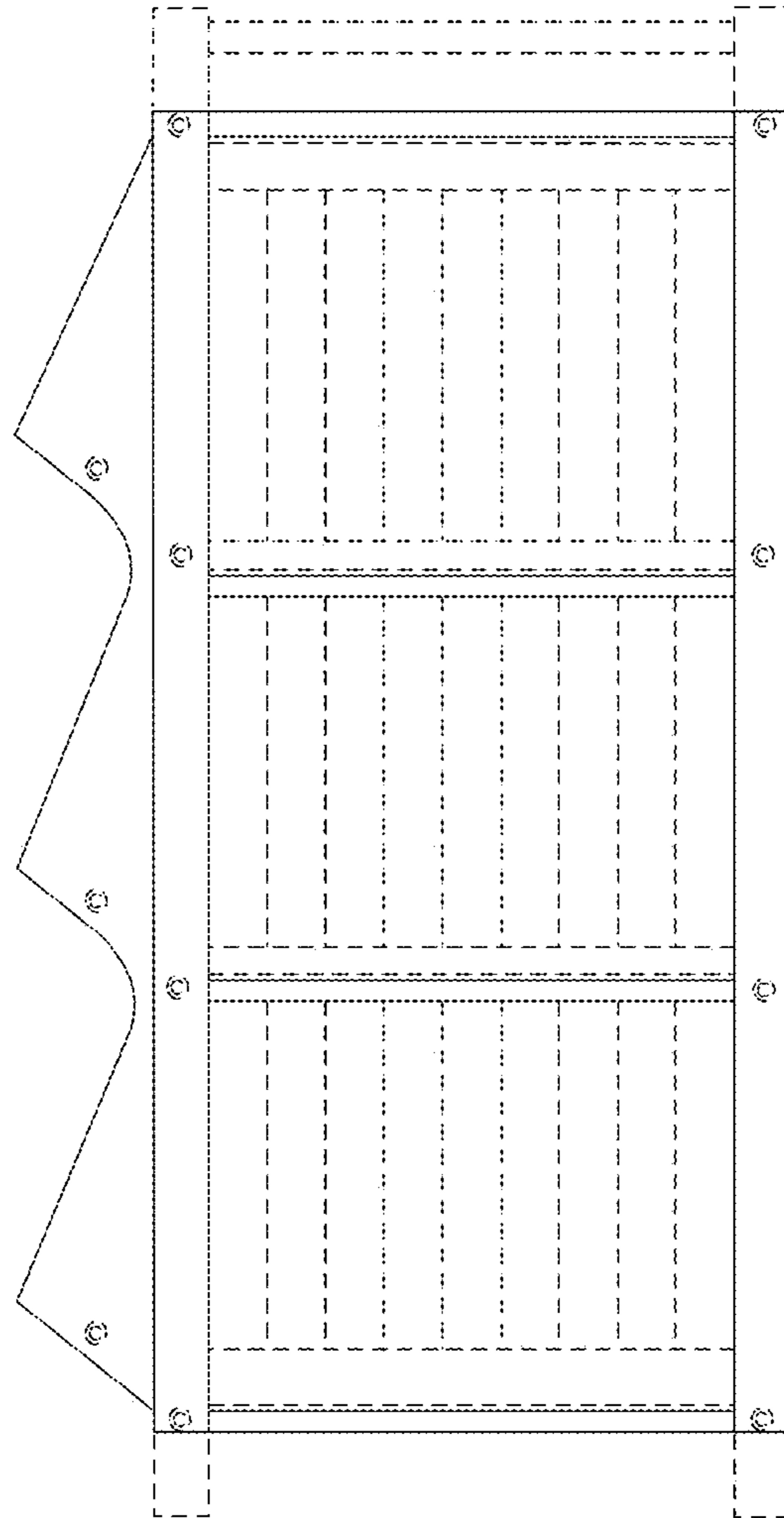

Fig. 6

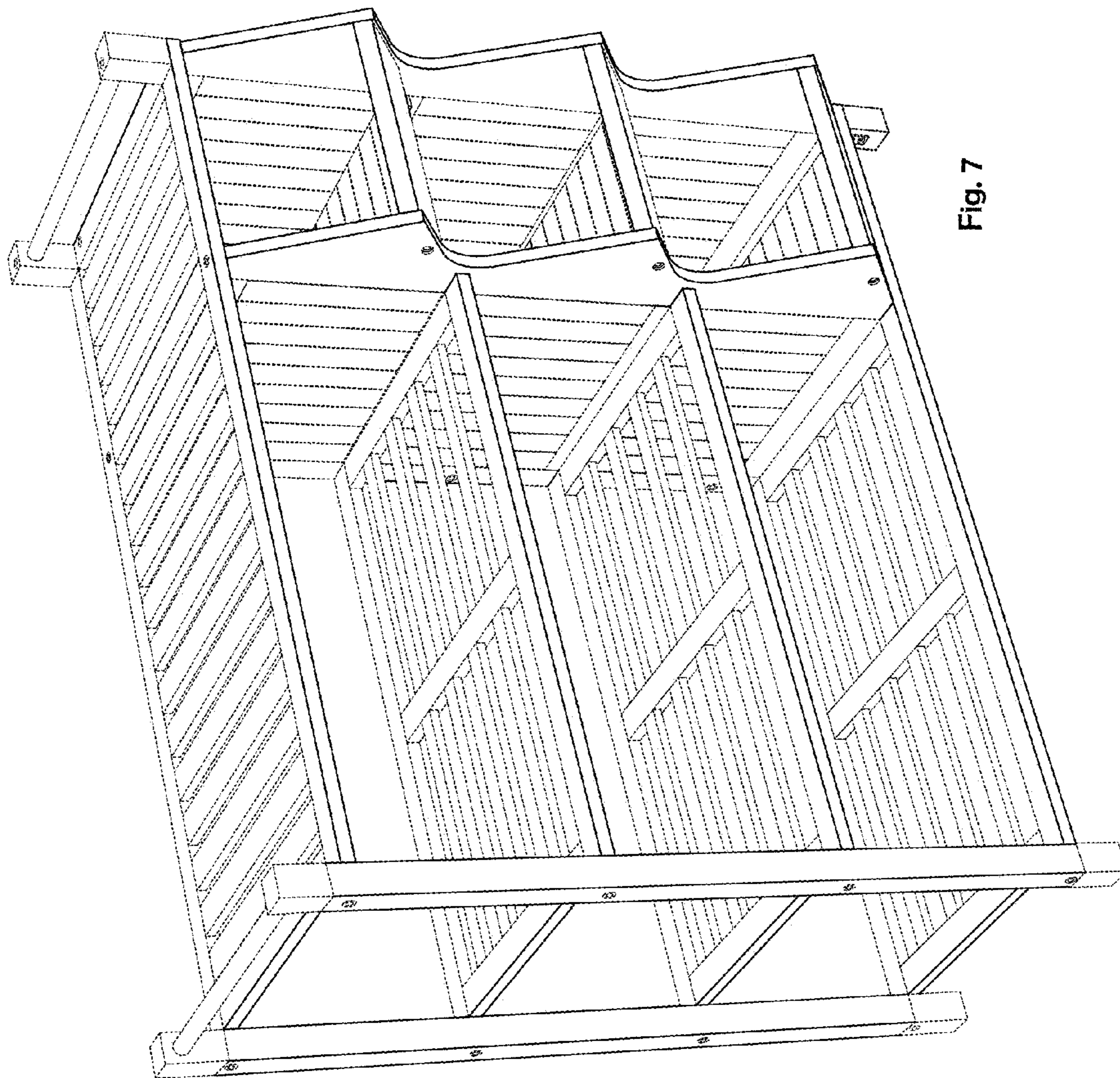

Fig. 7