



US00D680744S

(12) **United States Design Patent**
Rashid

(10) **Patent No.:** **US D680,744 S**
(45) **Date of Patent:** **** Apr. 30, 2013**

(54) **MOBILE PHONE CASE**

(75) Inventor: **Karim Rashid**, New York, NY (US)

(73) Assignee: **KDDI Corporation**, Tokyo (JP)

(**) Term: **14 Years**

(21) Appl. No.: **29/403,765**

(22) Filed: **Oct. 11, 2011**

(30) **Foreign Application Priority Data**

Apr. 11, 2011 (JP) 2011-008299

(51) **LOC (9) Cl.** **03-01**

(52) **U.S. Cl.**
USPC **D3/303**

(58) **Field of Classification Search** D3/290,
D3/303, 247, 249-253; 206/503-507, 509-510,
206/514-515, 518

See application file for complete search history.

(56) **References Cited**

U.S. PATENT DOCUMENTS

D388,250 S * 12/1997 Robinson et al. D3/245

D393,947 S * 5/1998 Alves et al. D3/303

* cited by examiner

Primary Examiner — Holly Baynham

(74) *Attorney, Agent, or Firm* — Westerman, Hattori,
Daniels & Adrian, LLP

(57) **CLAIM**

The ornamental design for a mobile phone case, as shown and described.

DESCRIPTION

FIG. 1 is a perspective view from the front side of a mobile phone case.

FIG. 2 is a perspective view from the rear side thereof.

FIG. 3 is a front elevation view thereof.

FIG. 4 is a rear elevation view thereof.

FIG. 5 is a top plan view thereof.

FIG. 6 is a bottom plan view thereof.

FIG. 7 is a left side elevation view thereof.

FIG. 8 is a right side elevation view thereof.

FIG. 9 is a cross-sectional view taken along the line 9-9 in FIG. 5.

FIG. 10 is a cross-sectional view taken along the line 10-10 in FIG. 5; and,

FIG. 11 is a perspective view showing the open position.

1 Claim, 11 Drawing Sheets

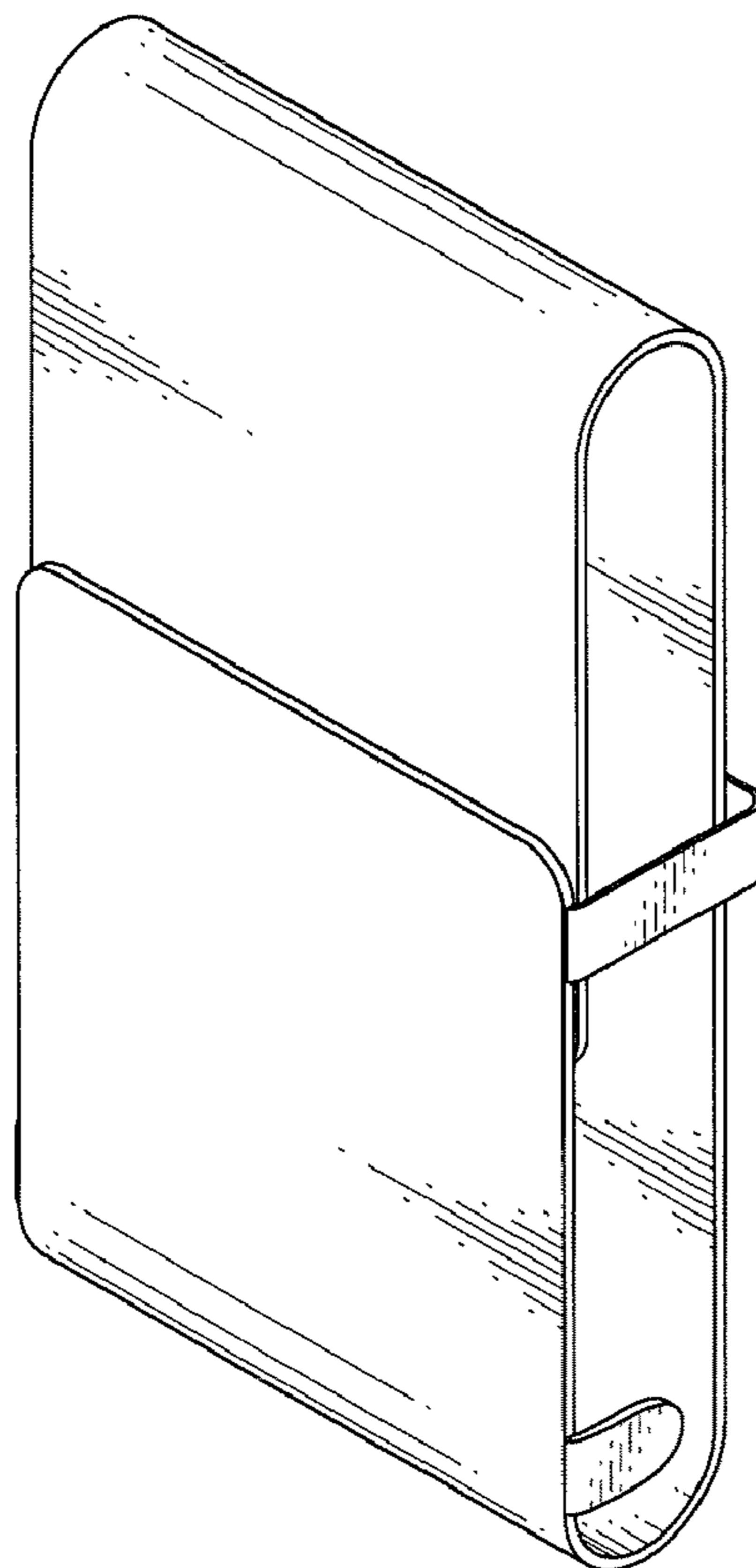

FIG. 1

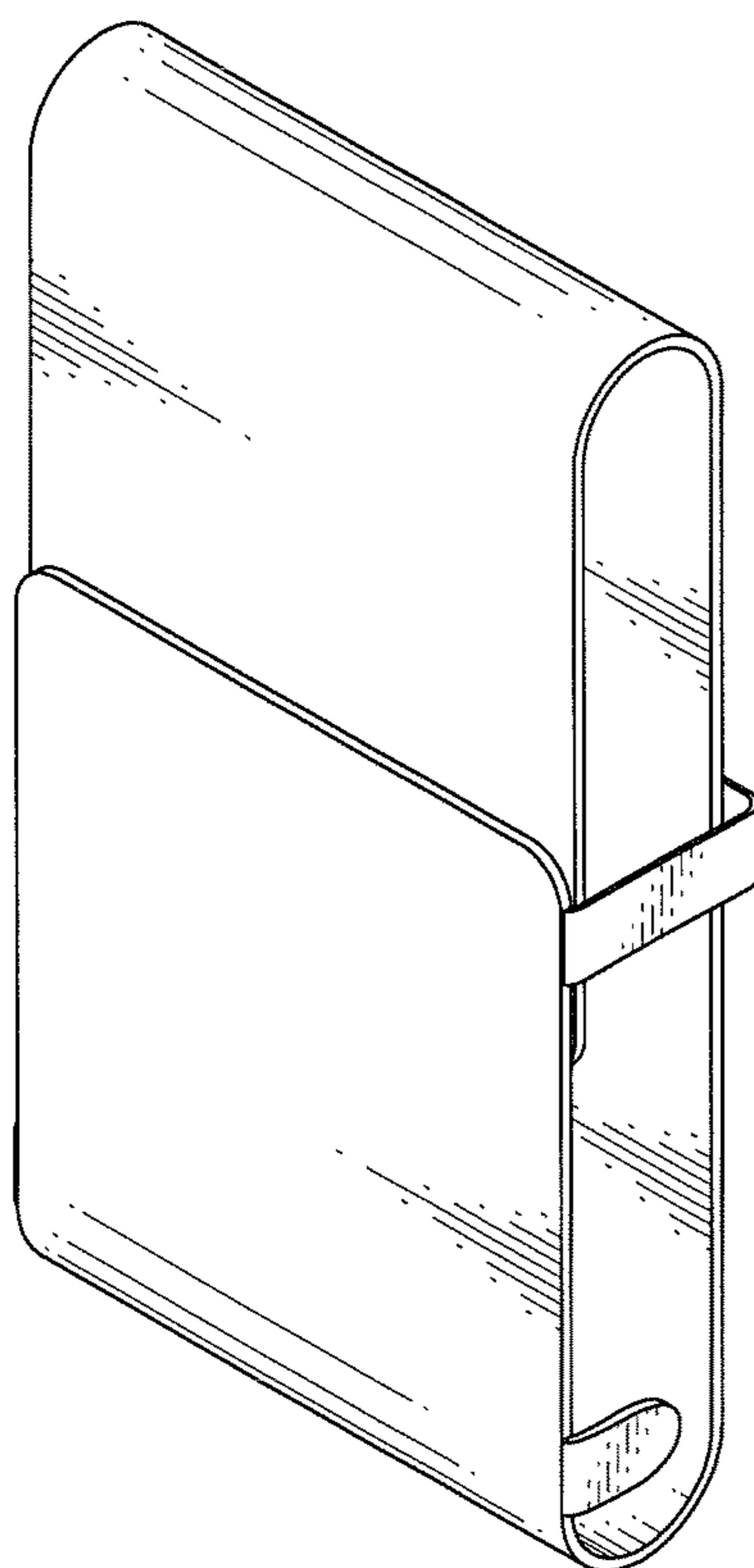

FIG. 2

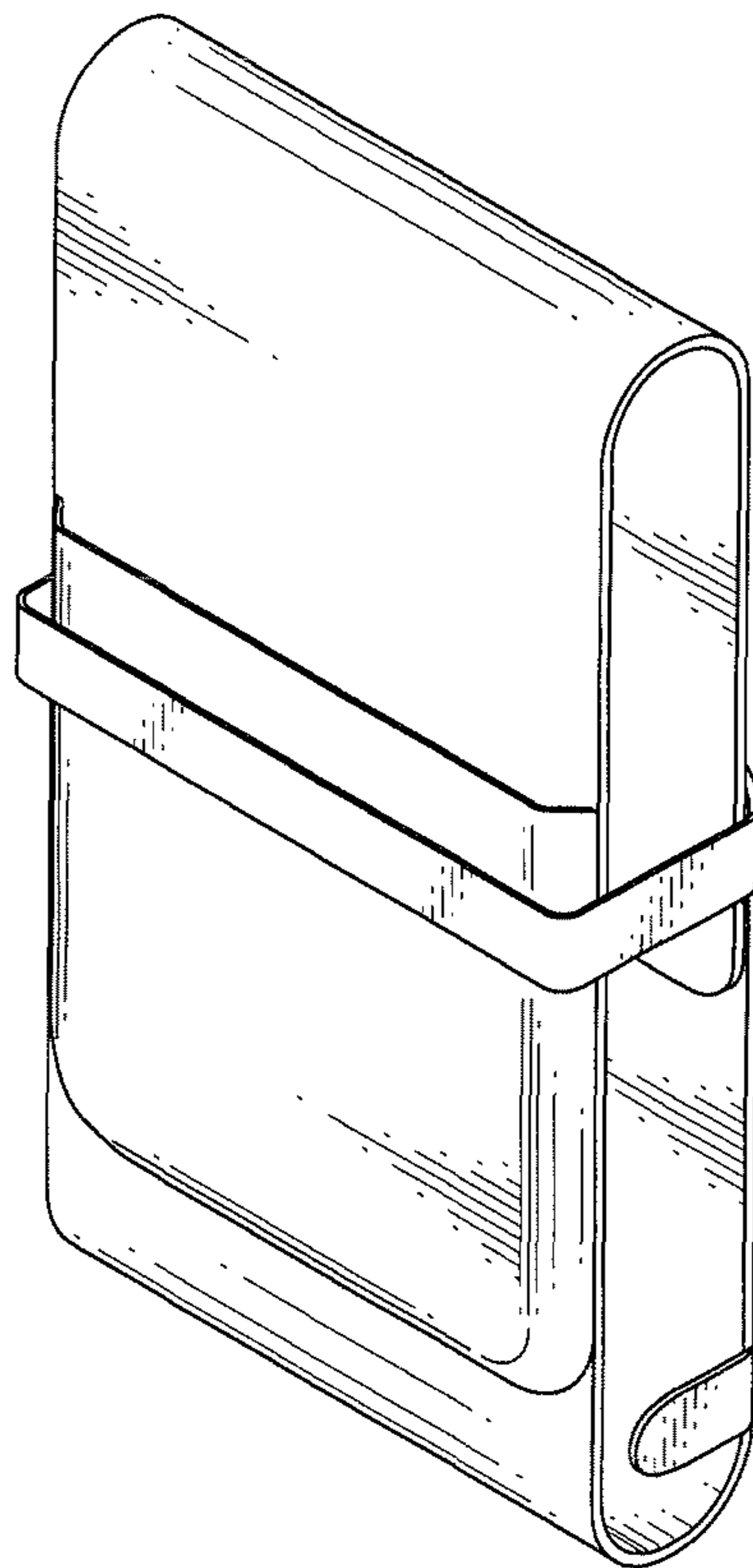

FIG. 3

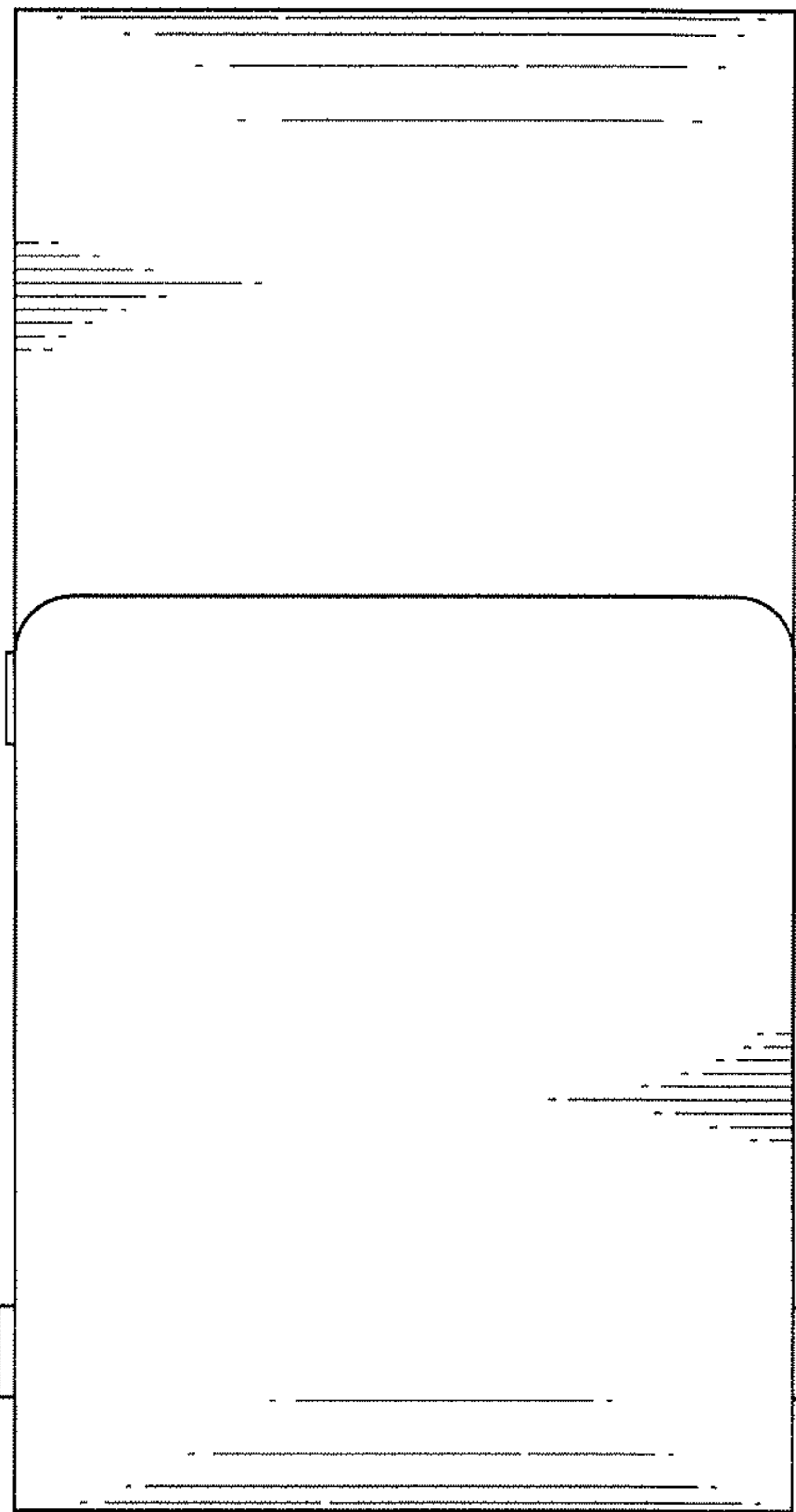

FIG. 4

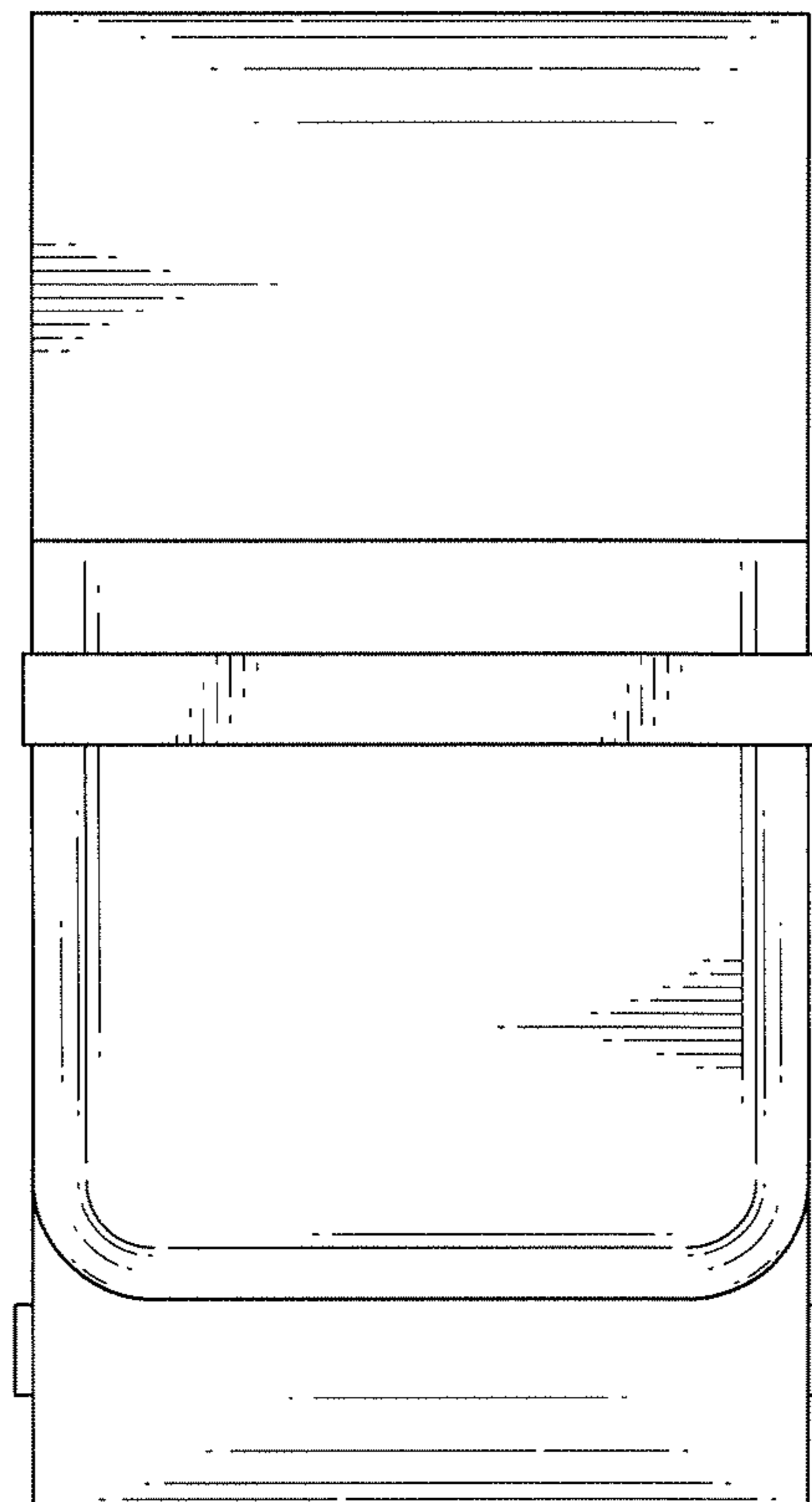

FIG. 5

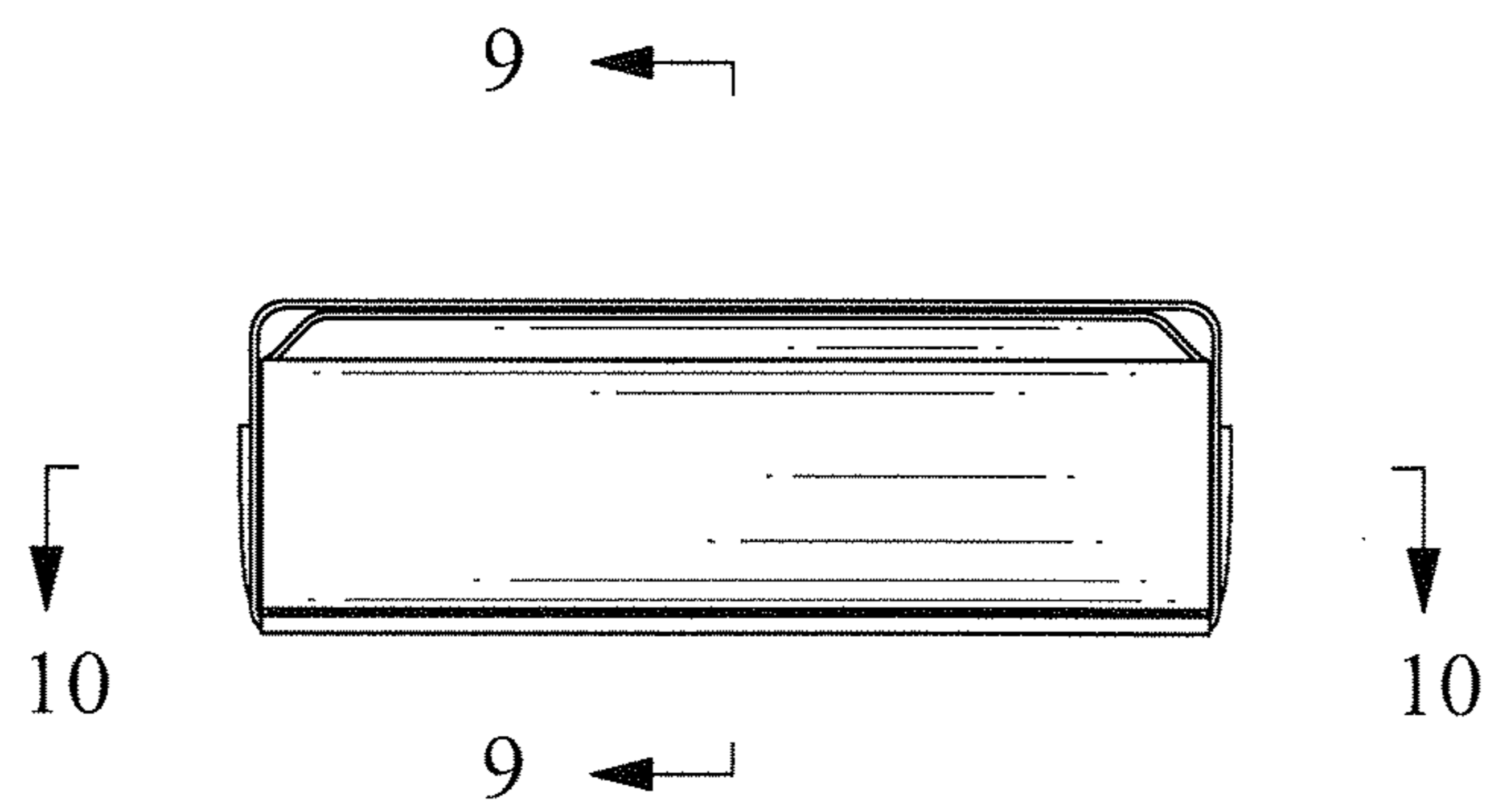

FIG. 6

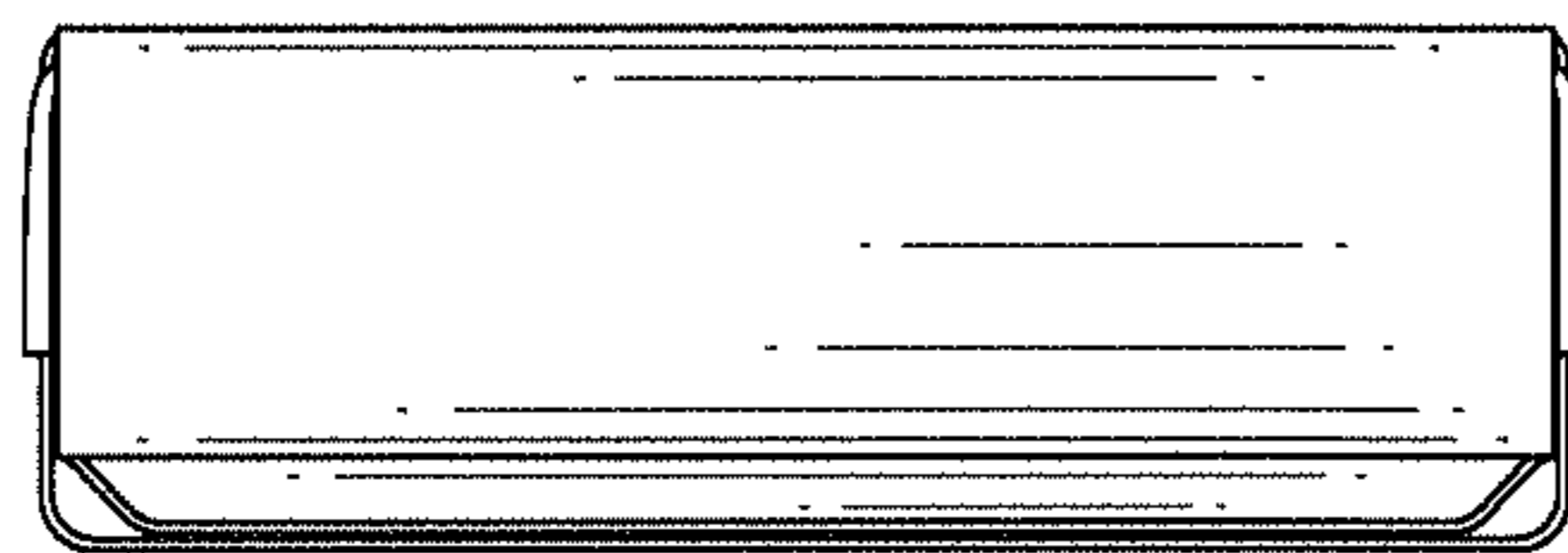

FIG. 7

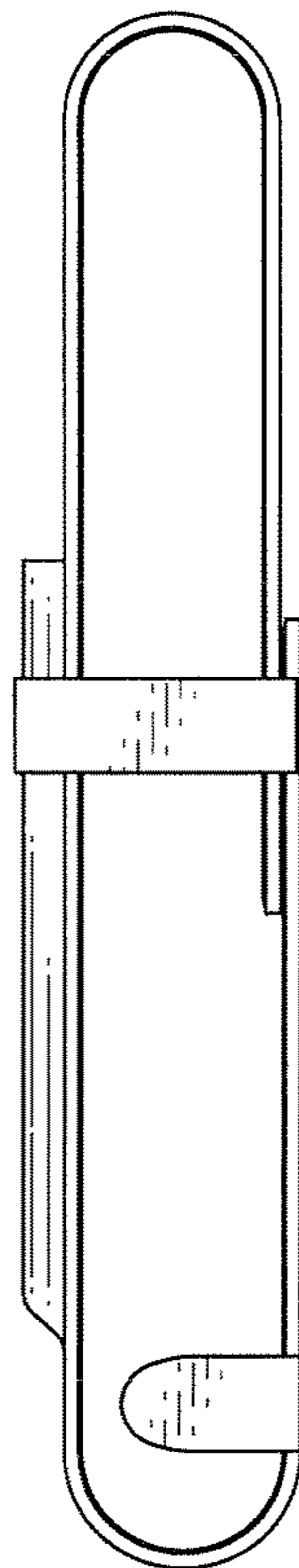

FIG. 8

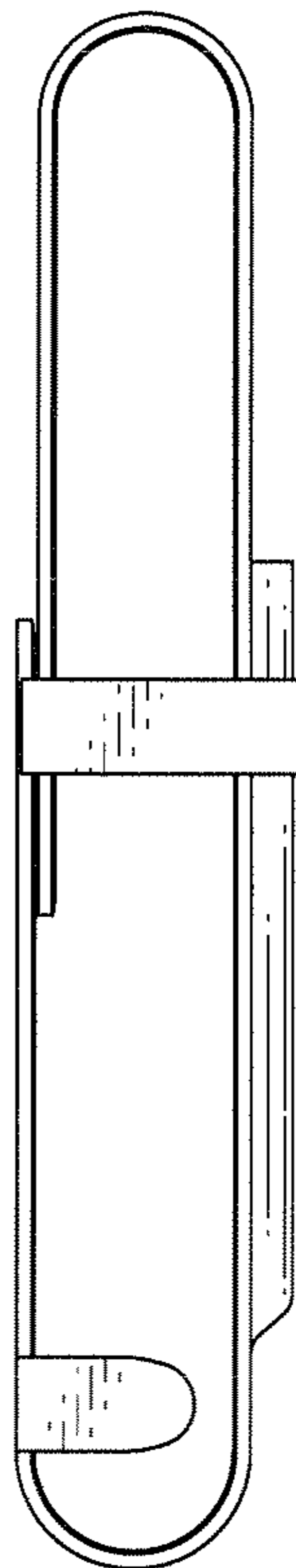

FIG. 9

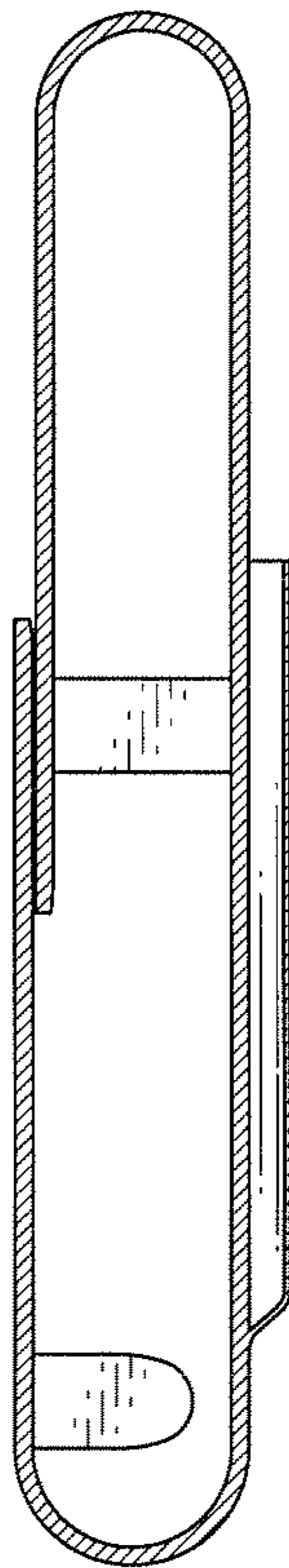

FIG. 10

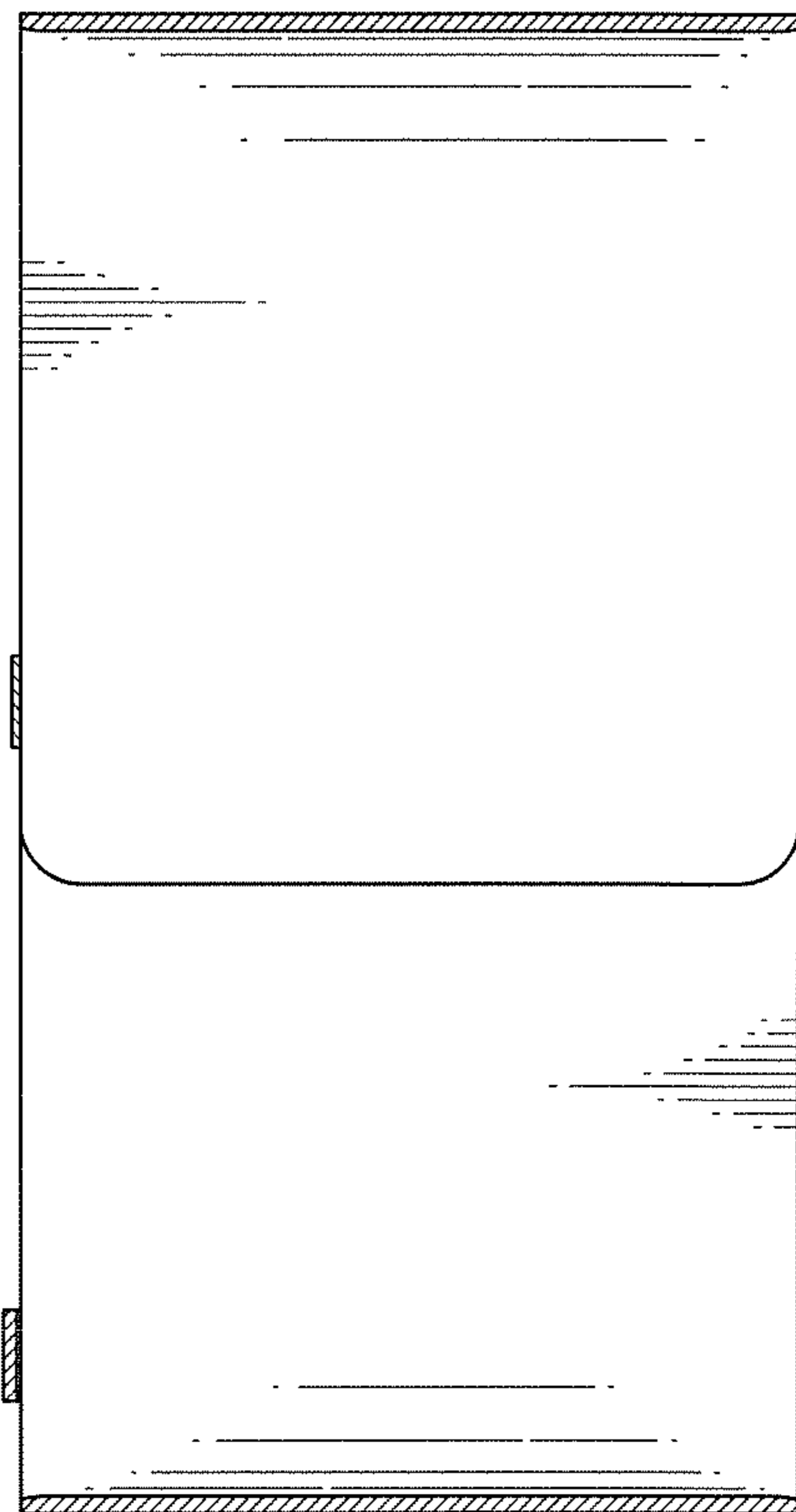

FIG. 11

