



US00D680719S

(12) **United States Design Patent**  
**Dardinski**

(10) **Patent No.:** **US D680,719 S**

(45) **Date of Patent:** **\*\* Apr. 30, 2013**

- (54) **FOLDING ZIPPER SHOE**
- (75) Inventor: **Alex Dardinski**, Newburyport, MA (US)
- (73) Assignee: **The Timberland Company**, Stratham, NH (US)
- (\*\*) Term: **14 Years**
- (21) Appl. No.: **29/390,987**
- (22) Filed: **May 2, 2011**
- (51) **LOC (9) Cl.** ..... **02-04**
- (52) **U.S. Cl.**  
USPC ..... **D2/947**
- (58) **Field of Classification Search** ..... D2/896,  
D2/902, 906–912, 925, 929, 943, 944, 946,  
D2/947, 949, 950, 951, 962, 969, 972, 977;  
36/83, 100, 102, 103, 104, 113, 114, 126–131,  
36/3 R, 3 A, 3 B, 14, 59 R, 67 R, 67 A  
See application file for complete search history.

- D559,508 S \* 1/2008 Cintron et al. .... D2/953
- D580,638 S \* 11/2008 McClaskie ..... D2/953
- 7,607,242 B2 10/2009 Karandonis et al.
- 7,637,035 B1 12/2009 Gillespie
- D610,785 S 3/2010 Smith

(Continued)

*Primary Examiner* — Elizabeth J Oswecki  
(74) *Attorney, Agent, or Firm* — Lerner, David, Littenberg, Krumholz & Mentlik, LLP

(57) **CLAIM**

The ornamental design for a folding zipper shoe, as shown and described.

**DESCRIPTION**

FIG. 1 is a perspective view of a folding zipper shoe showing my new design;  
 FIG. 2 is a right side view thereof;  
 FIG. 3 is a left side view thereof;  
 FIG. 4 is a front view thereof;  
 FIG. 5 is a back view thereof;  
 FIG. 6 is a top plan view thereof;  
 FIG. 7 is a bottom plan view thereof;  
 FIG. 8 is a perspective view of the folding zipper shoe of FIG. 1 shown in a closed configuration;  
 FIG. 9 is a view of a heel portion of the bottom of the folding zipper shoe shown in a closed configuration;  
 FIG. 10 is a view of a forefoot portion of the bottom of the folding zipper shoe shown in a closed configuration;  
 FIG. 11 is a left side view thereof;  
 FIG. 12 is a right side view thereof;  
 FIG. 13 is a top plan view thereof; and,  
 FIG. 14 is a bottom view of an arch portion of the folding zipper shoe shown in a closed configuration.  
 The broken lines shown in the drawings represent portions of the folding zipper shoe that form no part of the claimed design.

(56) **References Cited**

U.S. PATENT DOCUMENTS

905,432 A	12/1908	Jennings	
2,490,916 A	12/1949	Miller	
4,665,634 A	5/1987	Diaz	
5,184,410 A	2/1993	Hamilton	
5,481,814 A	1/1996	Spencer	
5,557,866 A	9/1996	Pregler	
5,813,144 A	9/1998	Pregler	
5,983,528 A	11/1999	Hartung et al.	
D424,284 S *	5/2000	von Conta et al. ....	D2/947
6,189,239 B1	2/2001	Gasparovic et al.	
D444,944 S	7/2001	Smith et al.	
6,594,921 B2	7/2003	Laio et al.	
D489,166 S *	5/2004	McClaskie .....	D2/953
D498,040 S *	11/2004	McClaskie .....	D2/954
D511,617 S *	11/2005	Matis .....	D2/977
7,032,327 B1	4/2006	Tartaglia et al.	
7,127,837 B2	10/2006	Ito	
7,168,190 B1	1/2007	Gillespie	

**1 Claim, 10 Drawing Sheets**

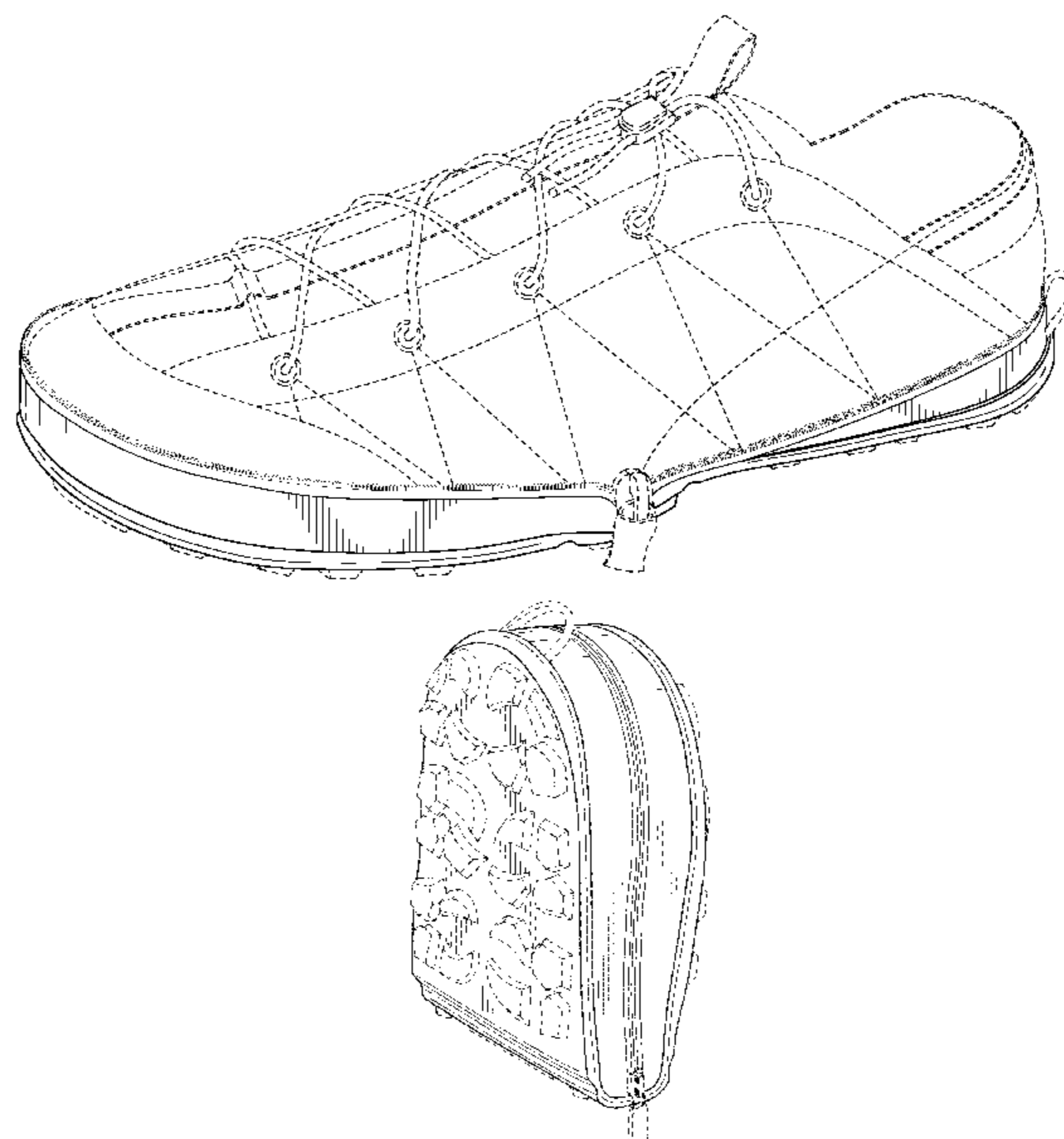

# US D680,719 S

Page 2

---

## U.S. PATENT DOCUMENTS

7,735,244	B1	6/2010	Ameche		2006/0185195	A1	8/2006	Weisner et al.
D636,566	S *	4/2011	Frantz .....	D2/946	2006/0242862	A1	11/2006	Chelani
D636,570	S *	4/2011	Merritt et al. ....	D2/951	2007/0204483	A1	9/2007	Kirsch et al.
D639,545	S *	6/2011	Weiss .....	D2/977	2008/0052964	A1	3/2008	Taylor
D643,189	S *	8/2011	Teteriatnikov .....	D2/946	2008/0110059	A1	5/2008	Kuramoto et al.
D644,824	S *	9/2011	Leleu .....	D2/946	2008/0168683	A1	7/2008	Keating
8,020,320	B2 *	9/2011	Gillespie .....	36/102	2009/0193685	A1	8/2009	Wilson
D653,842	S *	2/2012	Weiss .....	D2/946	2010/0018080	A1	1/2010	Smith
D662,698	S *	7/2012	Pulli et al. ....	D2/947	2010/0115793	A1	5/2010	Kraisosky
2006/0156576	A1	7/2006	Sloan		2010/0281713	A1	11/2010	Pantazes

\* cited by examiner

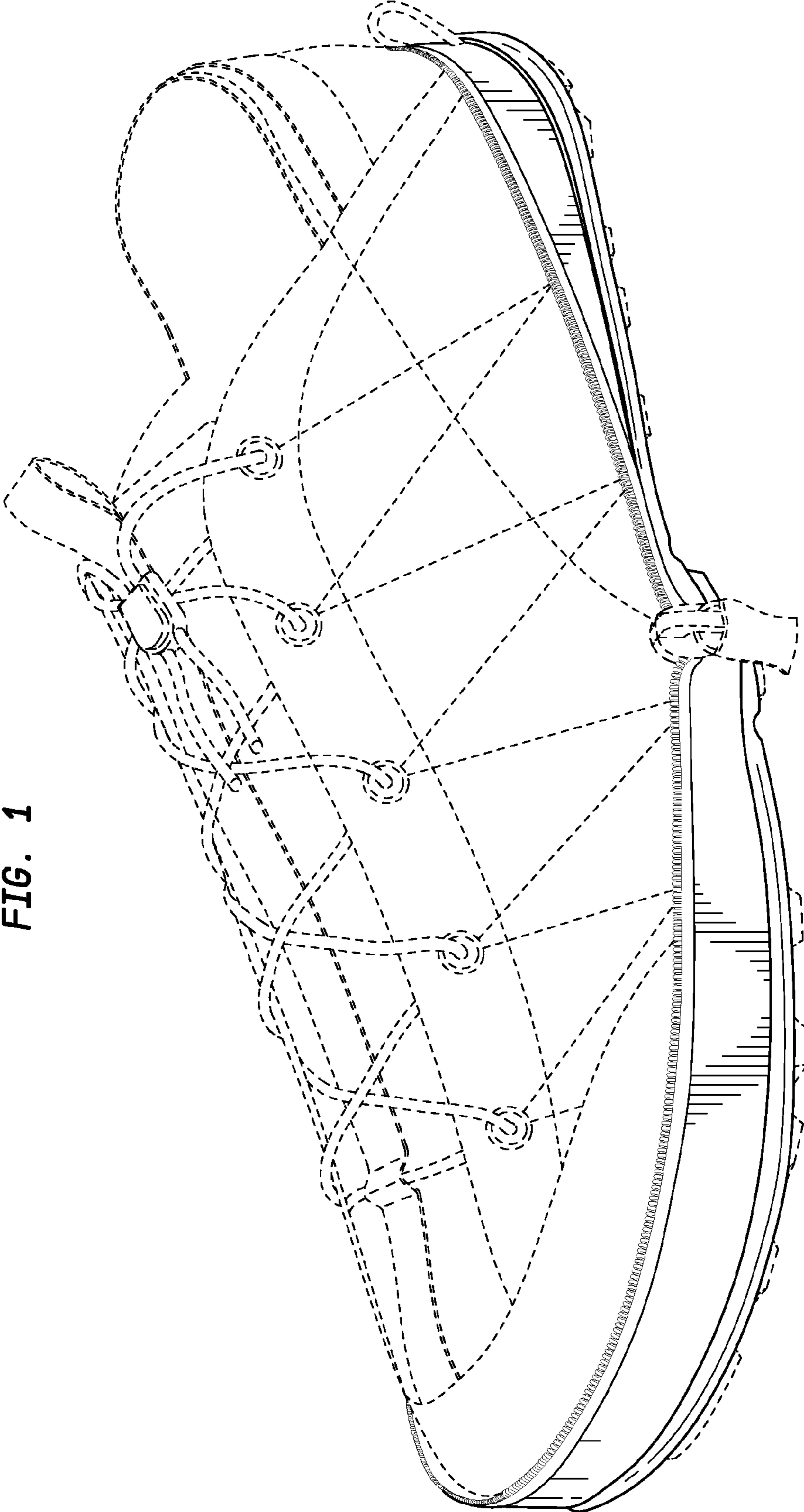

FIG. 1

FIG. 2

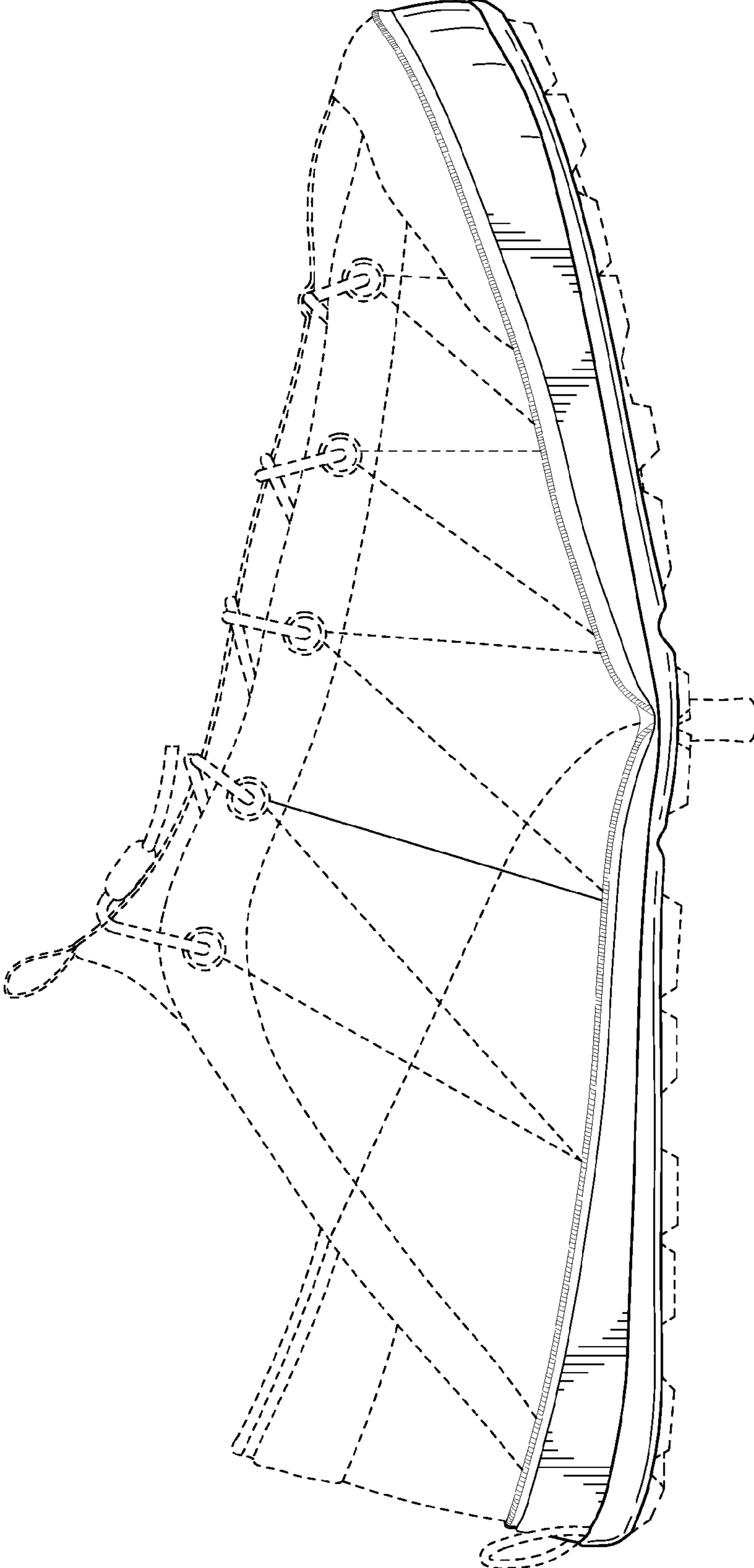

FIG. 3

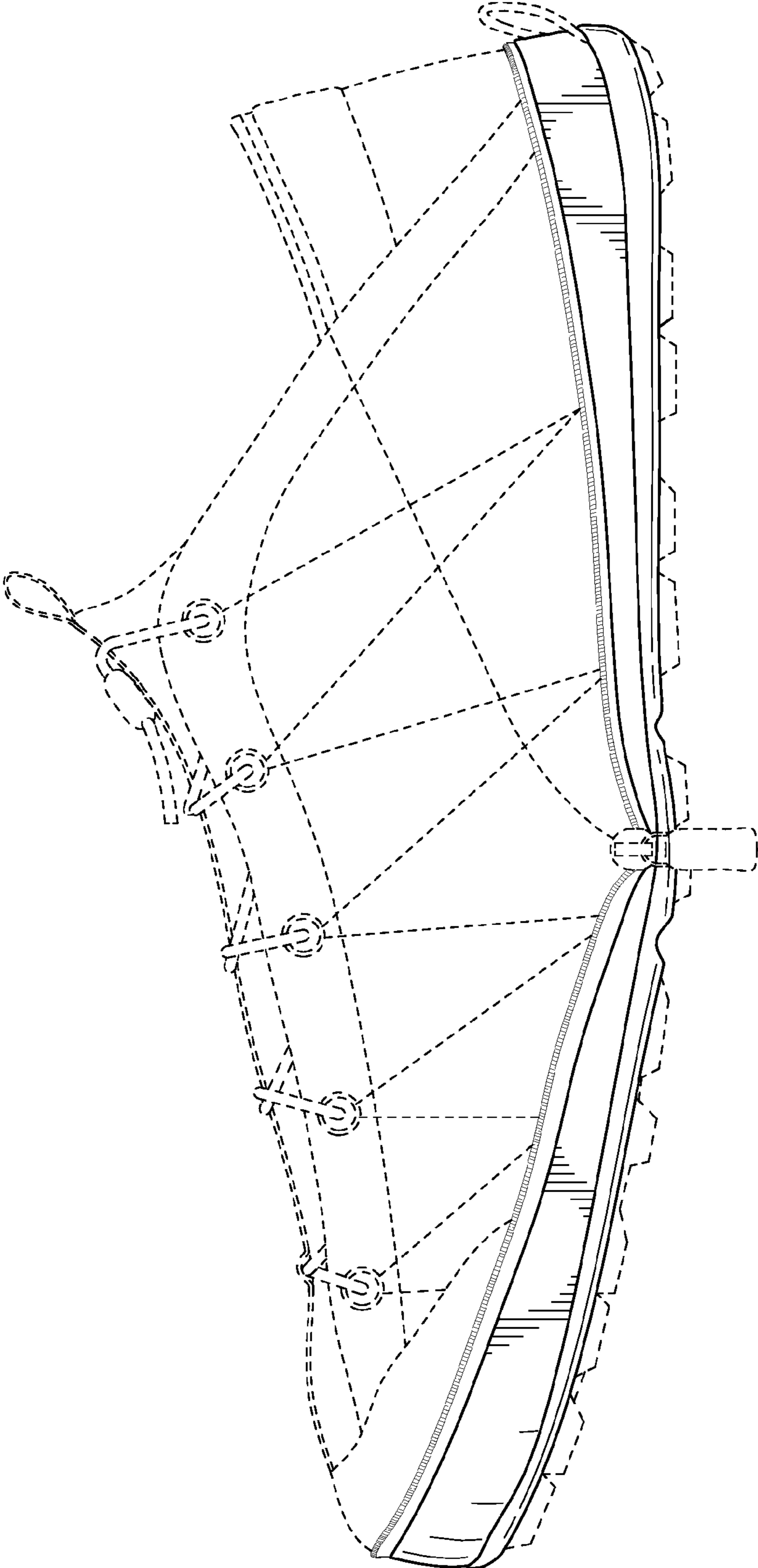

FIG. 4

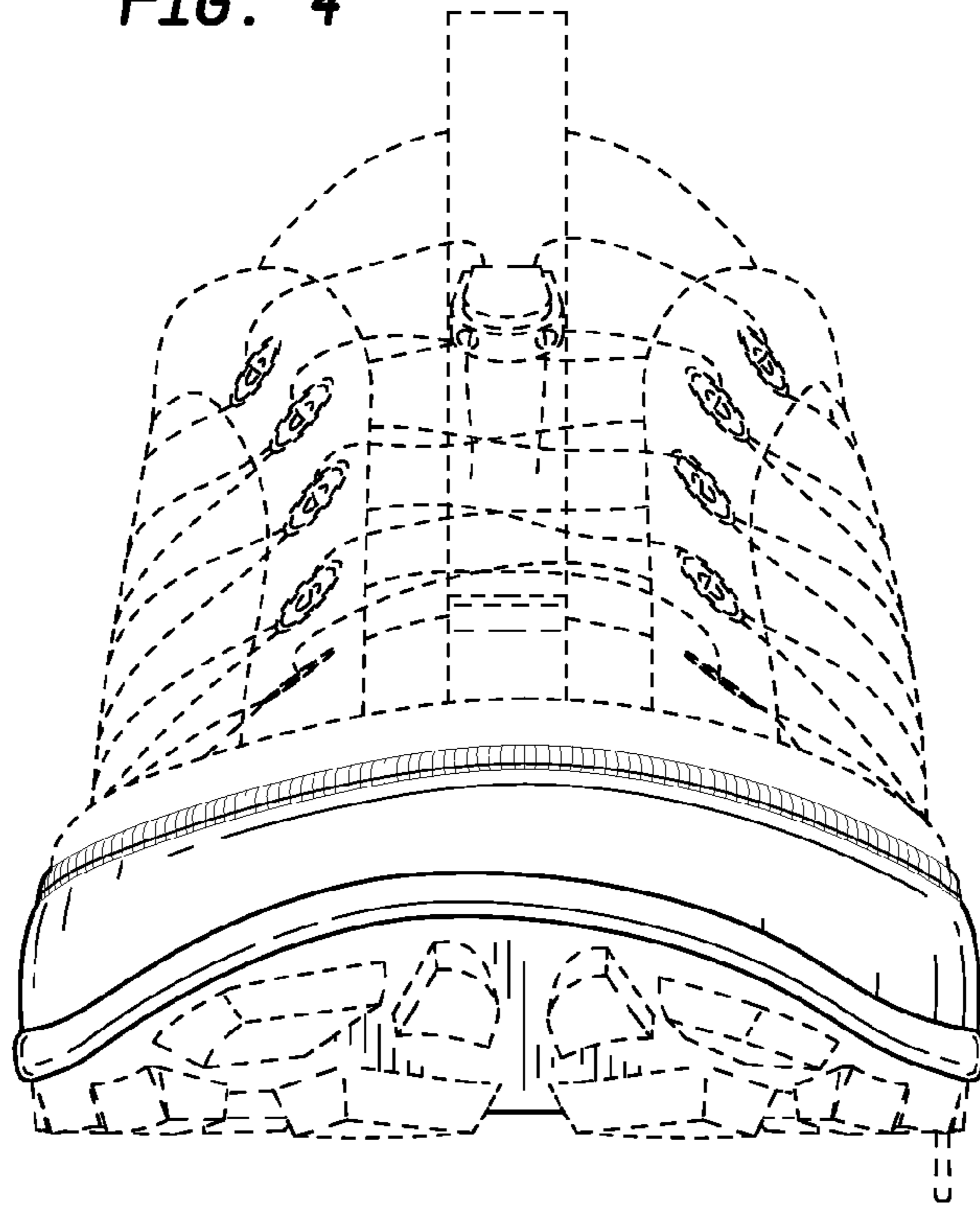

FIG. 5

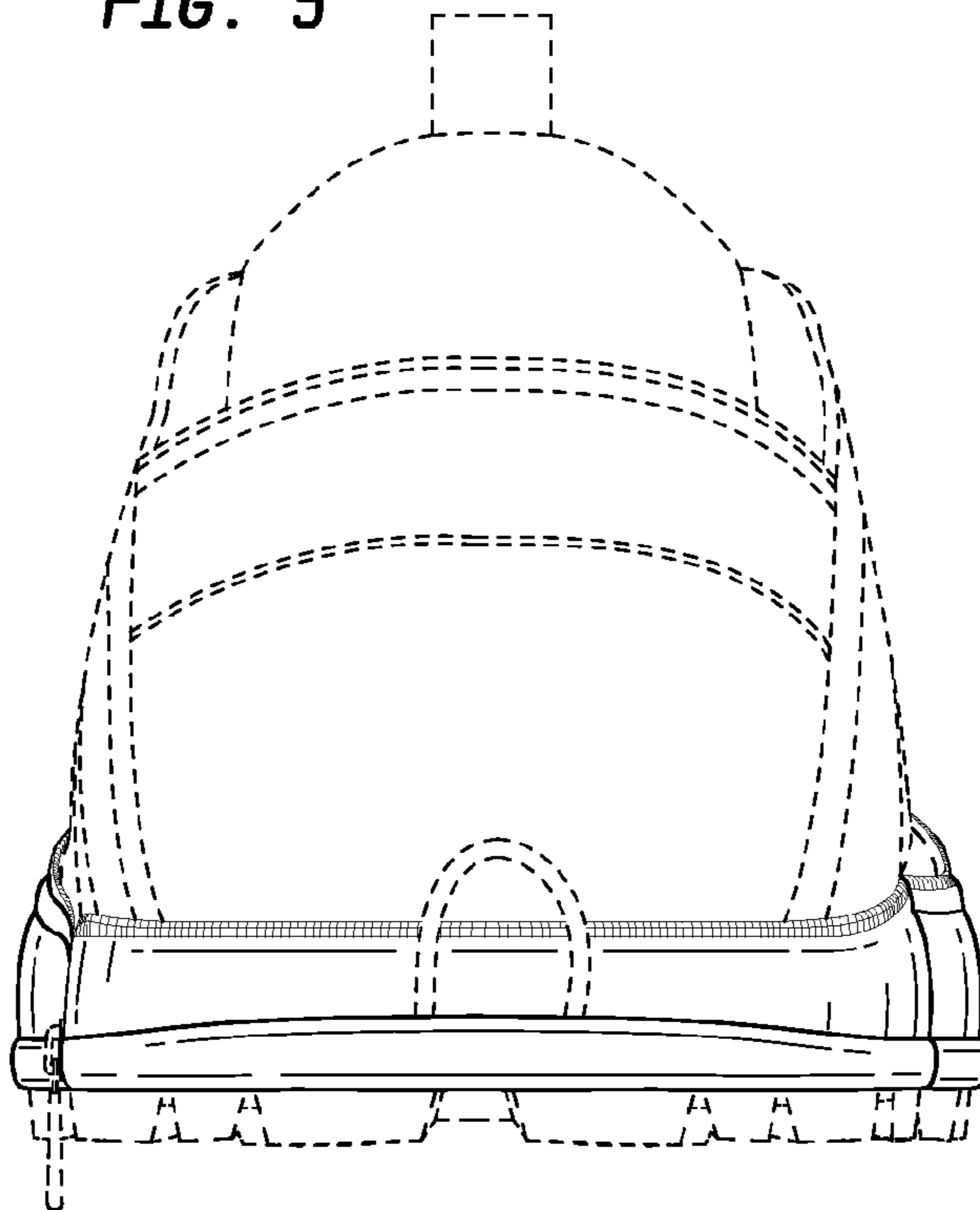

FIG. 6

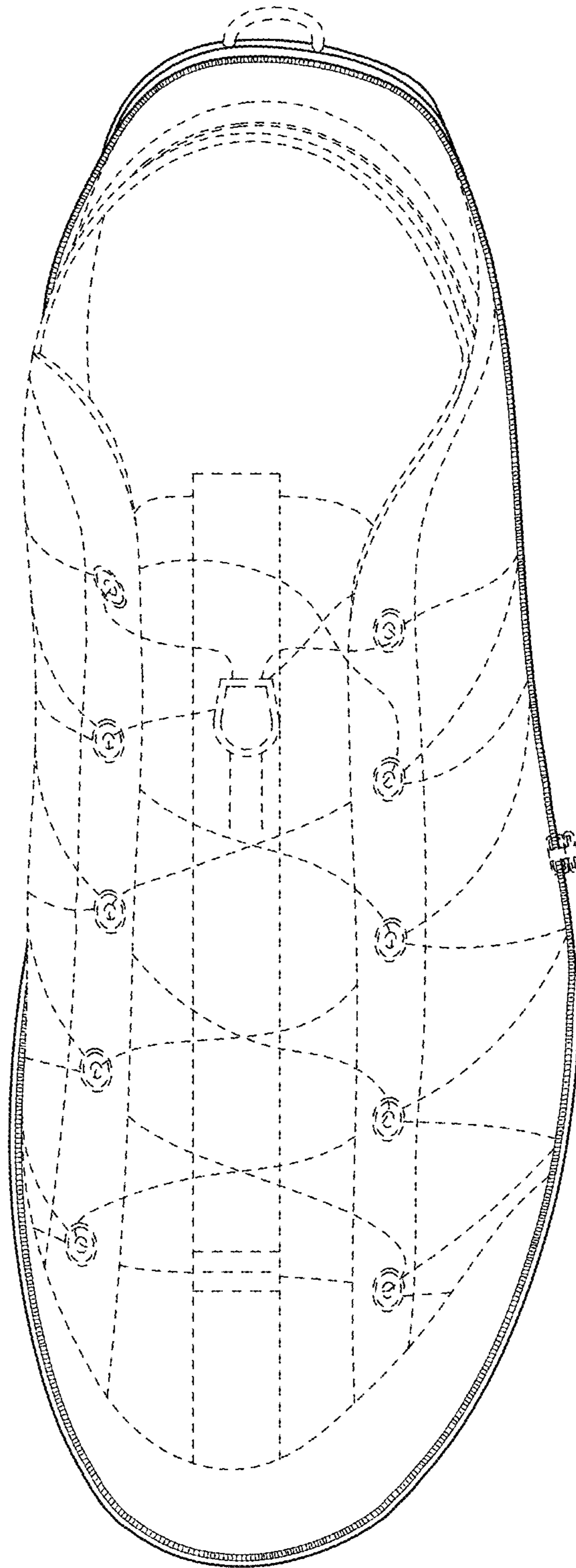

FIG. 7

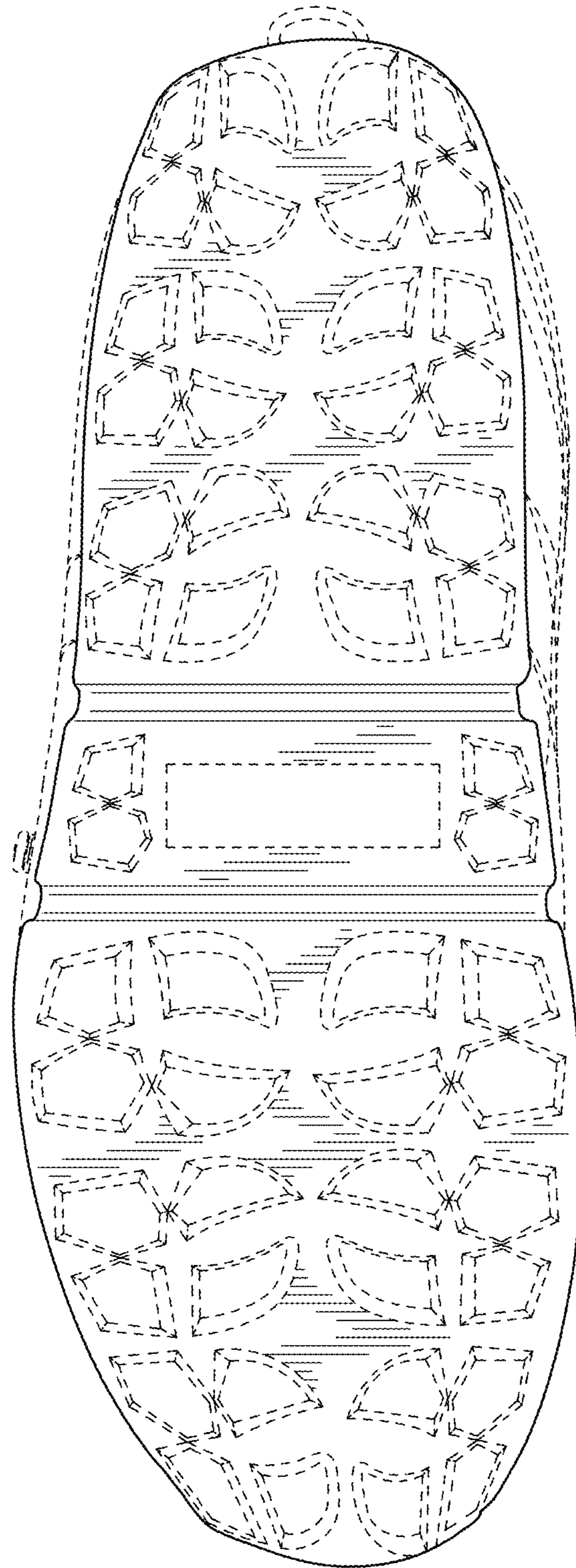



FIG. 8

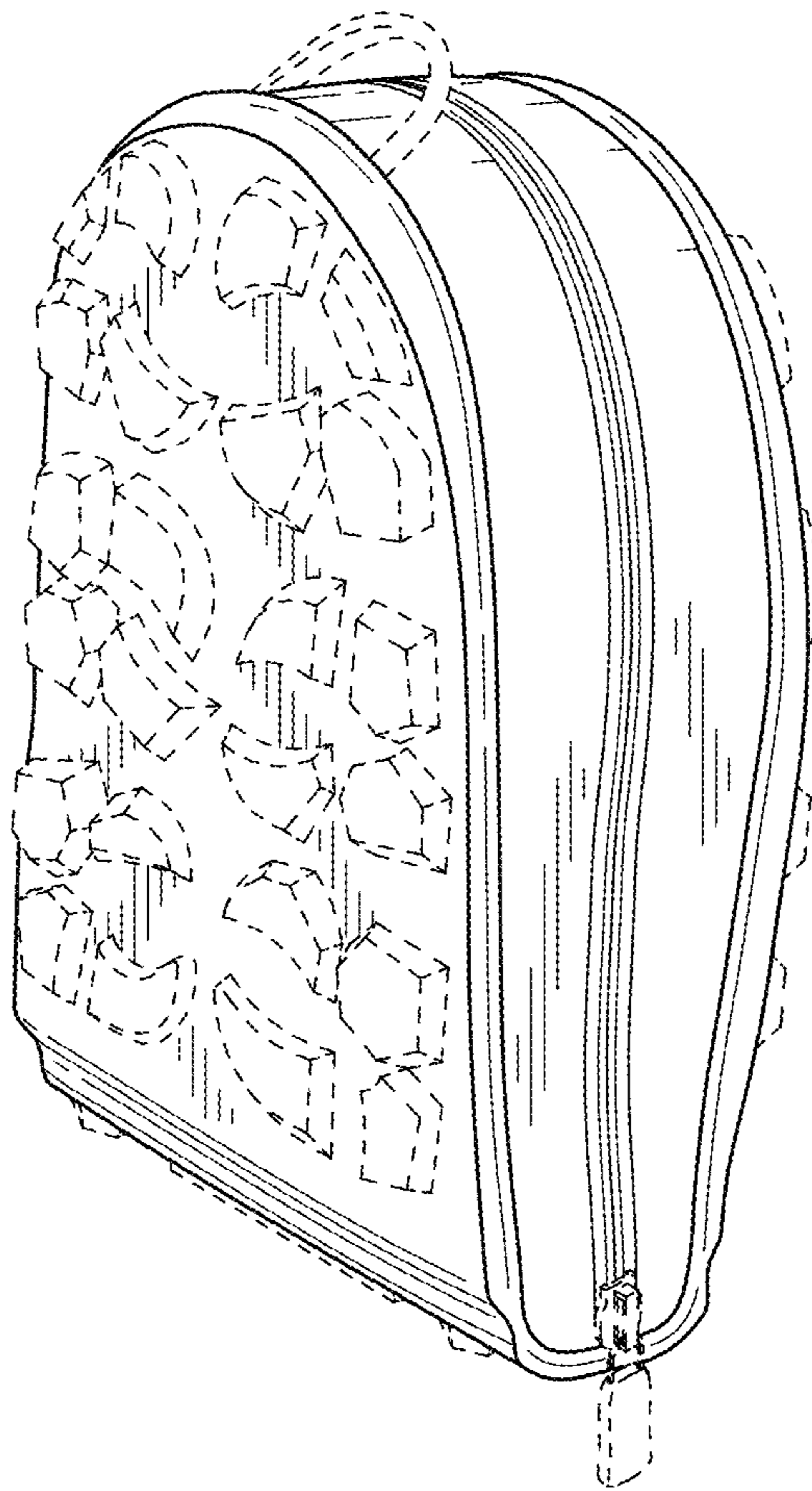

FIG. 9

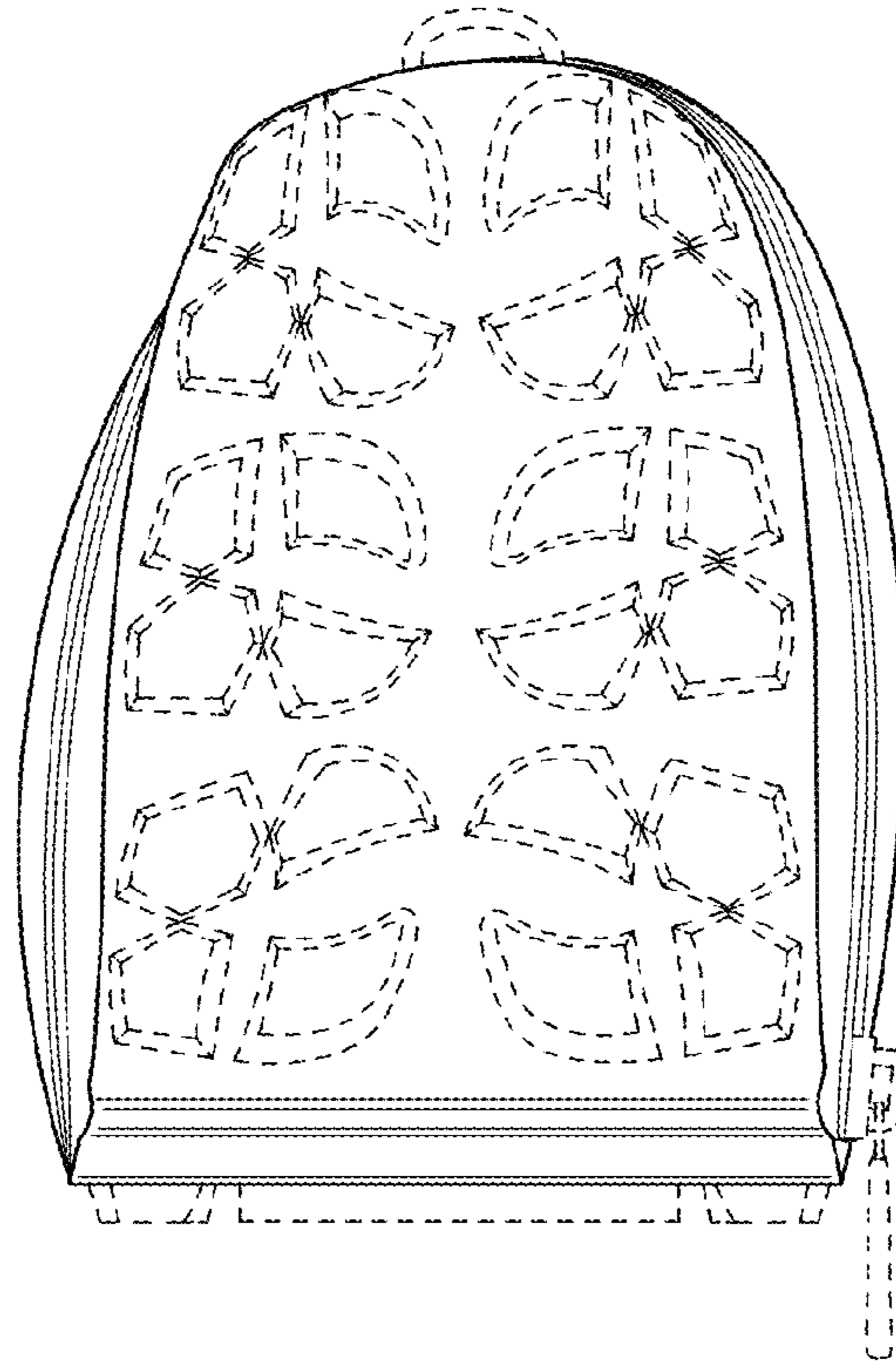
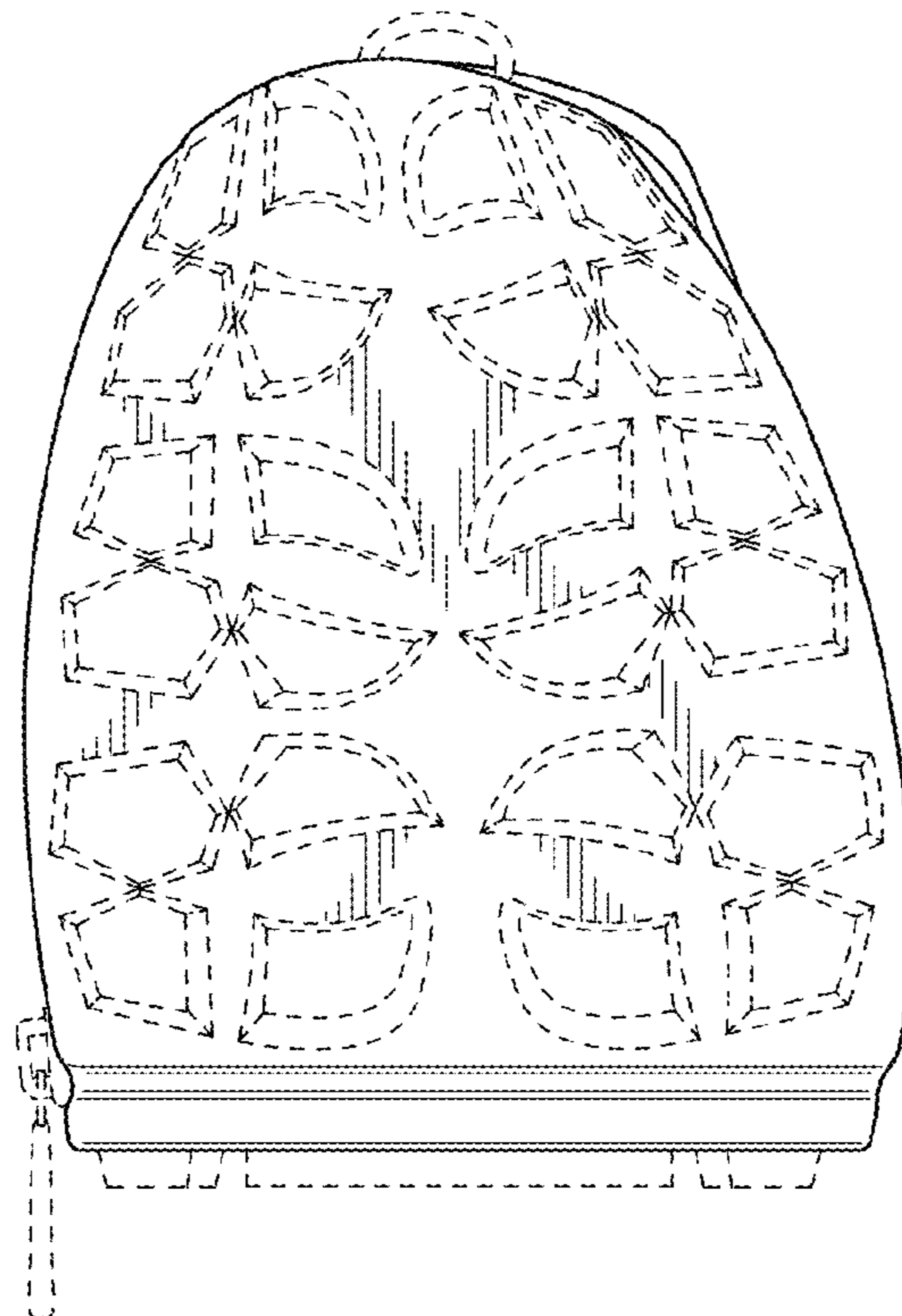
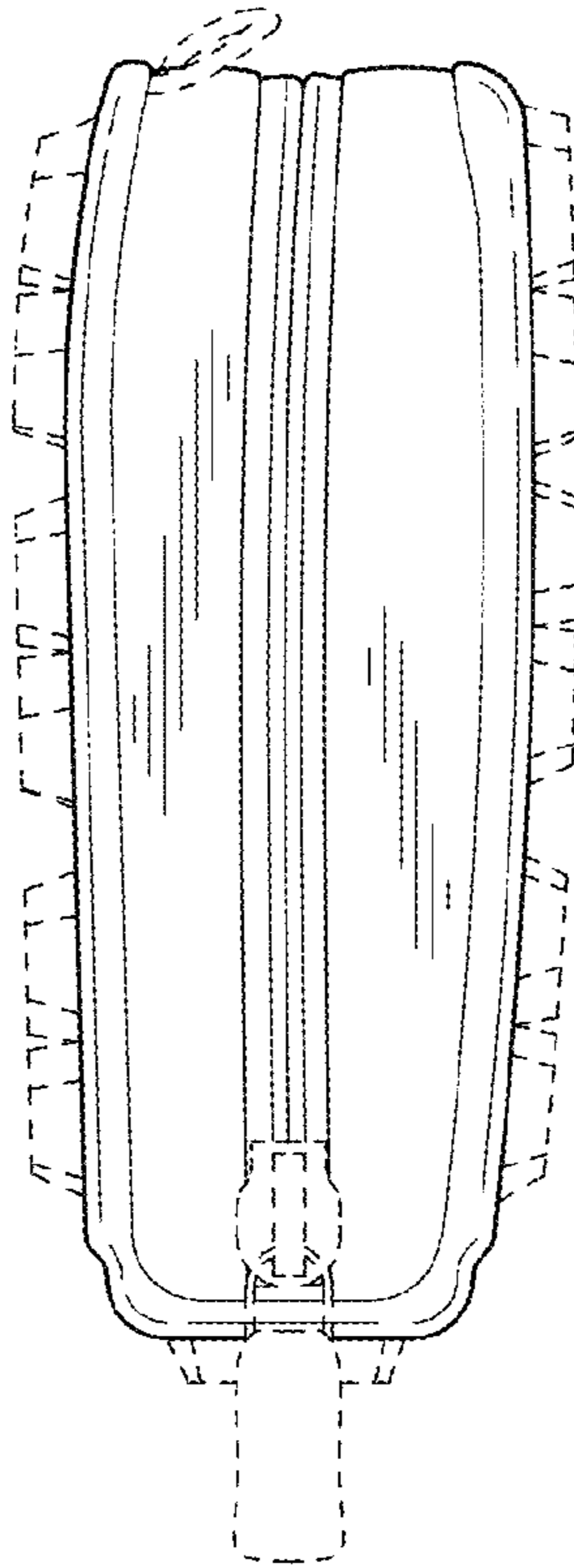

FIG. 10



**FIG. 11**



**FIG. 12**

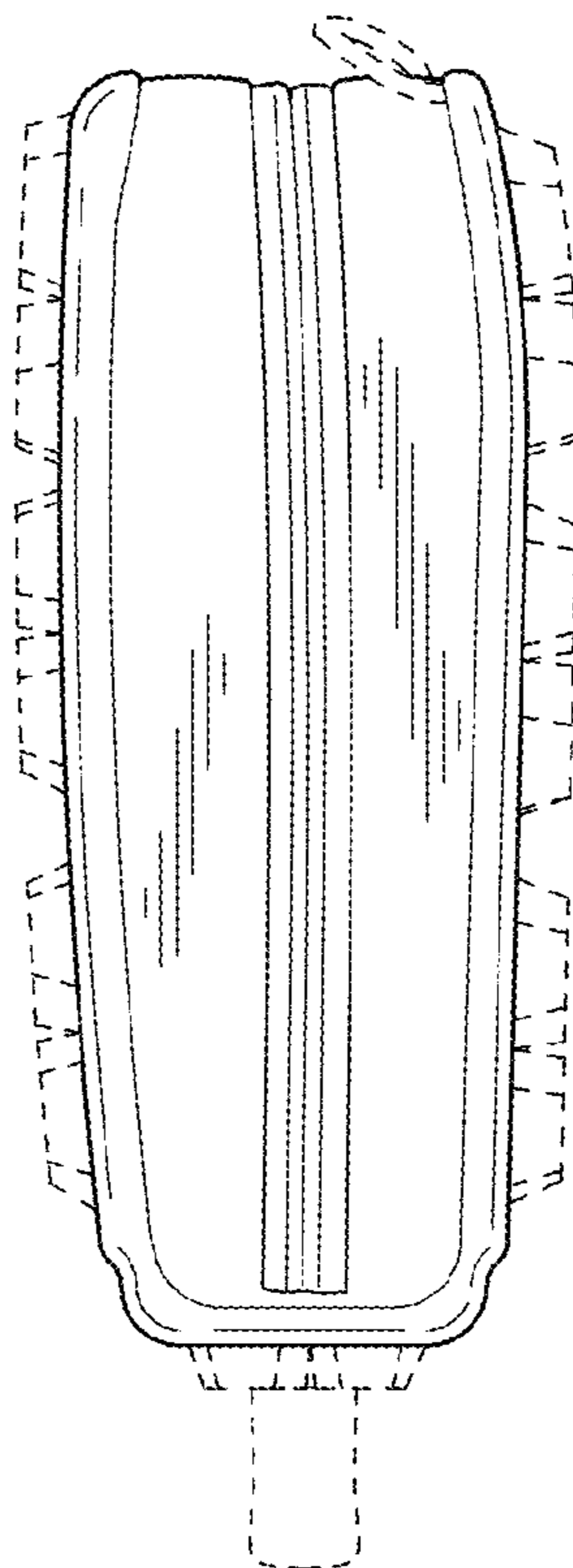

FIG. 13

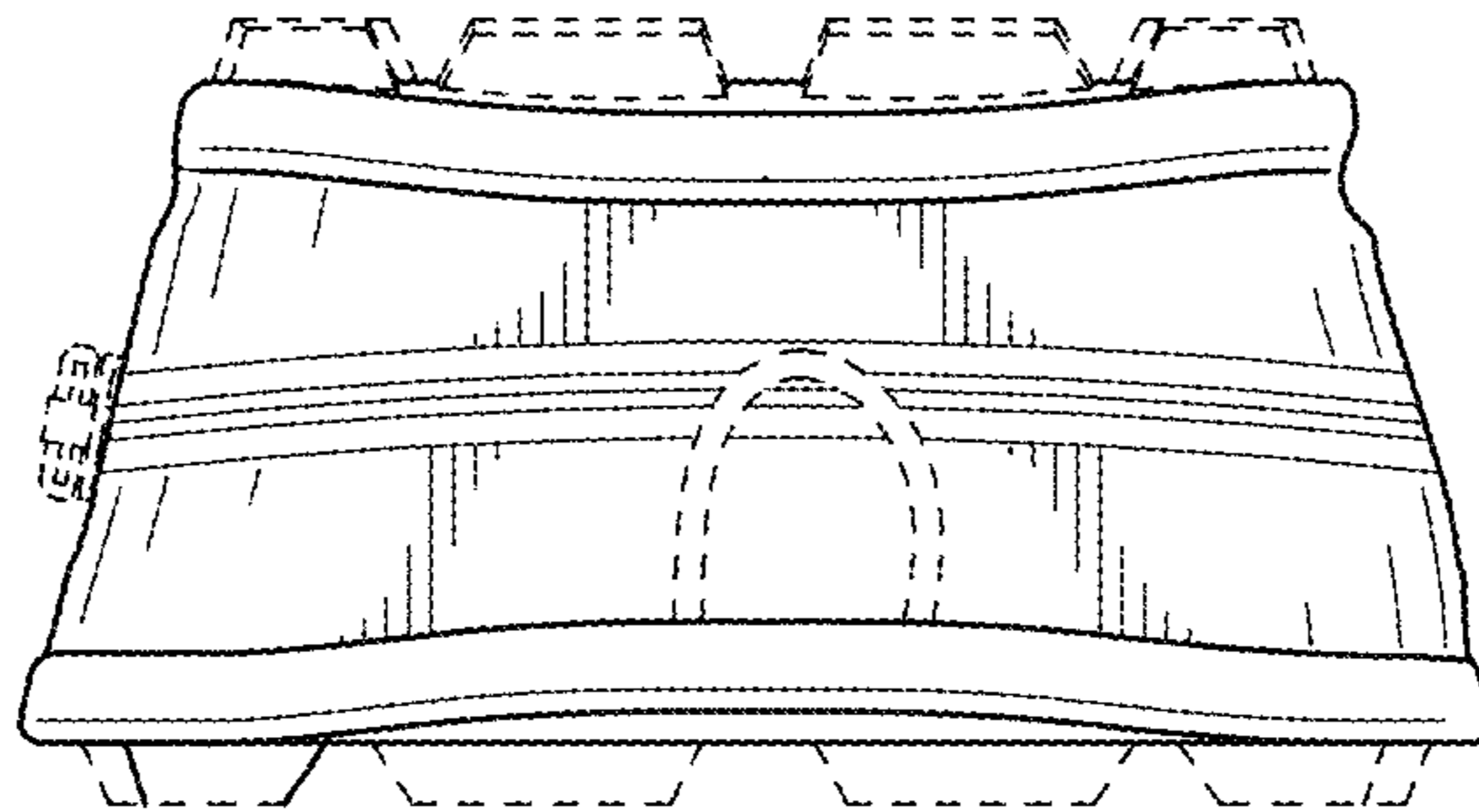

FIG. 14

