



US00D680515S

(12) **United States Design Patent**
Beeckmans et al.

(10) **Patent No.:** **US D680,515 S**

(45) **Date of Patent:** **** Apr. 23, 2013**

(54) **AUDIO/VIDEO RECORDER/PLAYER EQUIPMENT**

(75) Inventors: **Gilles Beeckmans**, Tervuren (BE);
Laurent Bourron, North Point (HK);
Frederick Donnet, Tai Po (HK)

(73) Assignee: **Gingo Biloba, S.A.**, Hong Kong (HK)

(**) Term: **14 Years**

(21) Appl. No.: **29/396,597**

(22) Filed: **Jul. 1, 2011**

(30) **Foreign Application Priority Data**

Jan. 4, 2011 (EM) 1253090

(51) **LOC (9) Cl.** **14-01**

(52) **U.S. Cl.**
USPC **D14/172**

(58) **Field of Classification Search** D14/204,
D14/209–216, 135, 168, 172, 502, 188, 194,
D14/197, 167, 497, 125, 238.1, 239, 265;
181/143, 144, 147, 148, 150, 157, 198, 199,
181/151, 153; 381/330–302, 306, 333, 345,
381/361–364, 386–388, 331, 336; 340/286.01;
369/6–12; 455/344, 347–351

See application file for complete search history.

(56) **References Cited**

U.S. PATENT DOCUMENTS

5,437,552 A * 8/1995 Baer et al. 434/317
5,896,454 A * 4/1999 Cookson et al. 360/60
D457,153 S * 5/2002 Allen D14/168
D483,729 S * 12/2003 Huang et al. D14/506

D501,842 S * 2/2005 Hussaini et al. D14/172
D544,463 S * 6/2007 Harris D14/168
7,636,235 B2 * 12/2009 Langberg et al. 361/679.23
7,929,291 B2 * 4/2011 Park et al. 361/679.41
7,962,383 B2 * 6/2011 Egendorf 705/30
8,175,646 B2 * 5/2012 Rofougaran 455/557

* cited by examiner

Primary Examiner — Prabhakar Deshmukh

(74) *Attorney, Agent, or Firm* — Kirschstein, et al.

(57) **CLAIM**

The ornamental design for audio/video recorder/player equipment, as shown and described.

DESCRIPTION

FIG. 1 is a top plan view of an audio/video recorder/player equipment showing our new design;
FIG. 2 is a left side perspective view thereof;
FIG. 3 is a top plan view of central console of audio/video recorder/player thereof, shown separately for clarity;
FIG. 4 is a front elevational view of FIG. 3;
FIG. 5 is a rear elevational view of FIG. 3;
FIG. 6 is a bottom plan view of FIG. 3;
FIG. 7 is a right side elevational view of FIG. 3;
FIG. 8 is a left side elevational view of FIG. 3;
FIG. 9 is a top plan view of either end speaker of audio/video recorder/player, shown separately for clarity;
FIG. 10 is a front elevational view of FIG. 9;
FIG. 11 is a rear elevational view of FIG. 9;
FIG. 12 is a bottom plan view of FIG. 9;
FIG. 13 is a right side elevational view of FIG. 9; and,
FIG. 14 is a left side elevational view of FIG. 9.

1 Claim, 6 Drawing Sheets

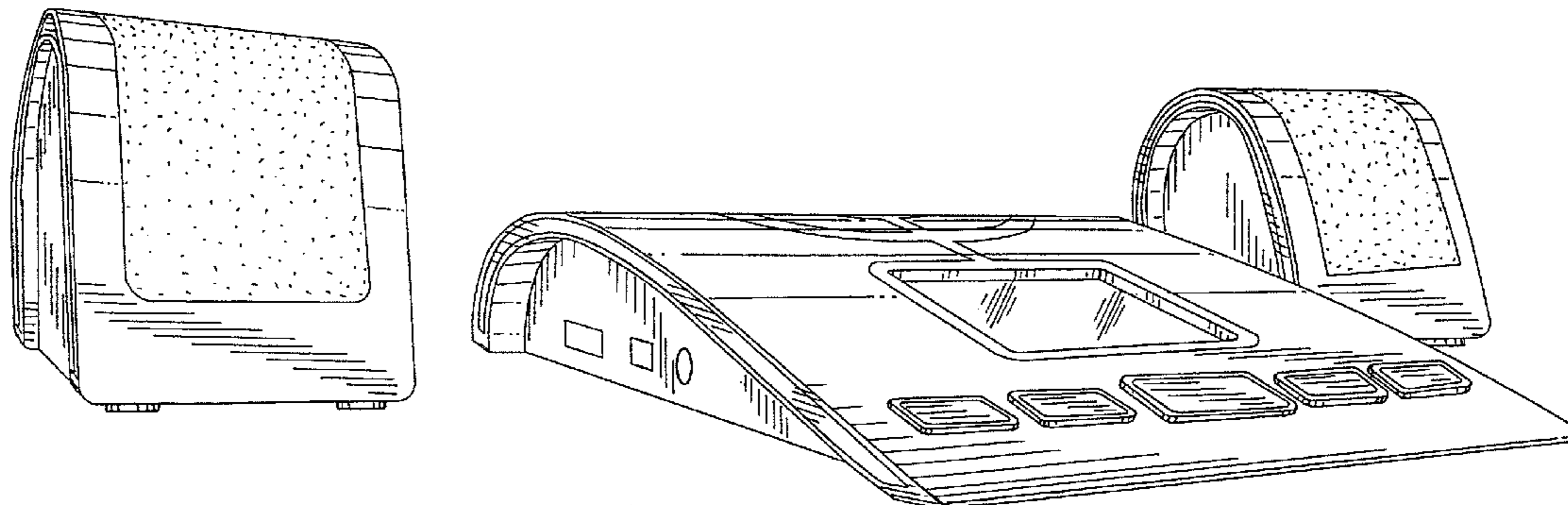

FIG. 1

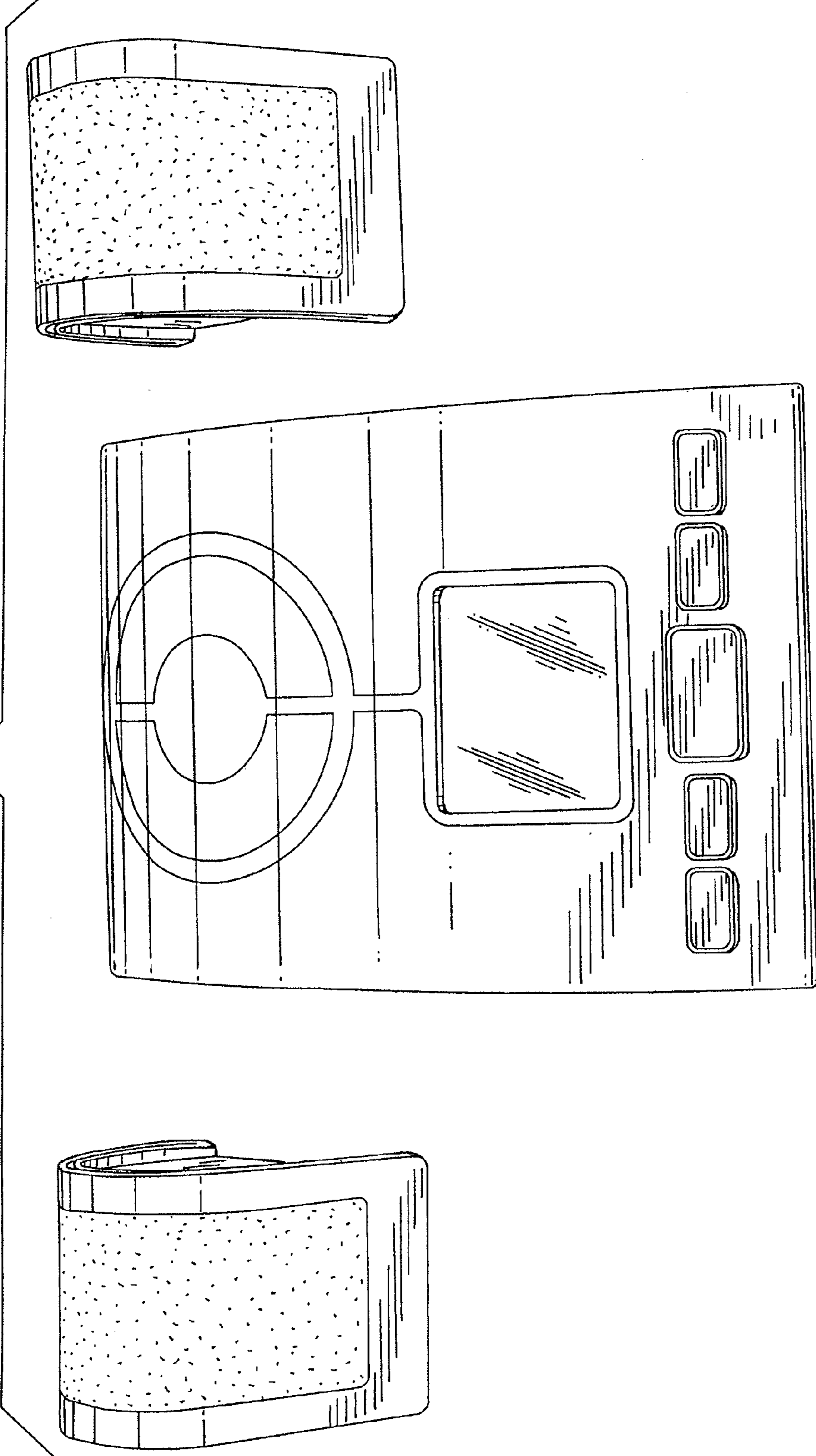
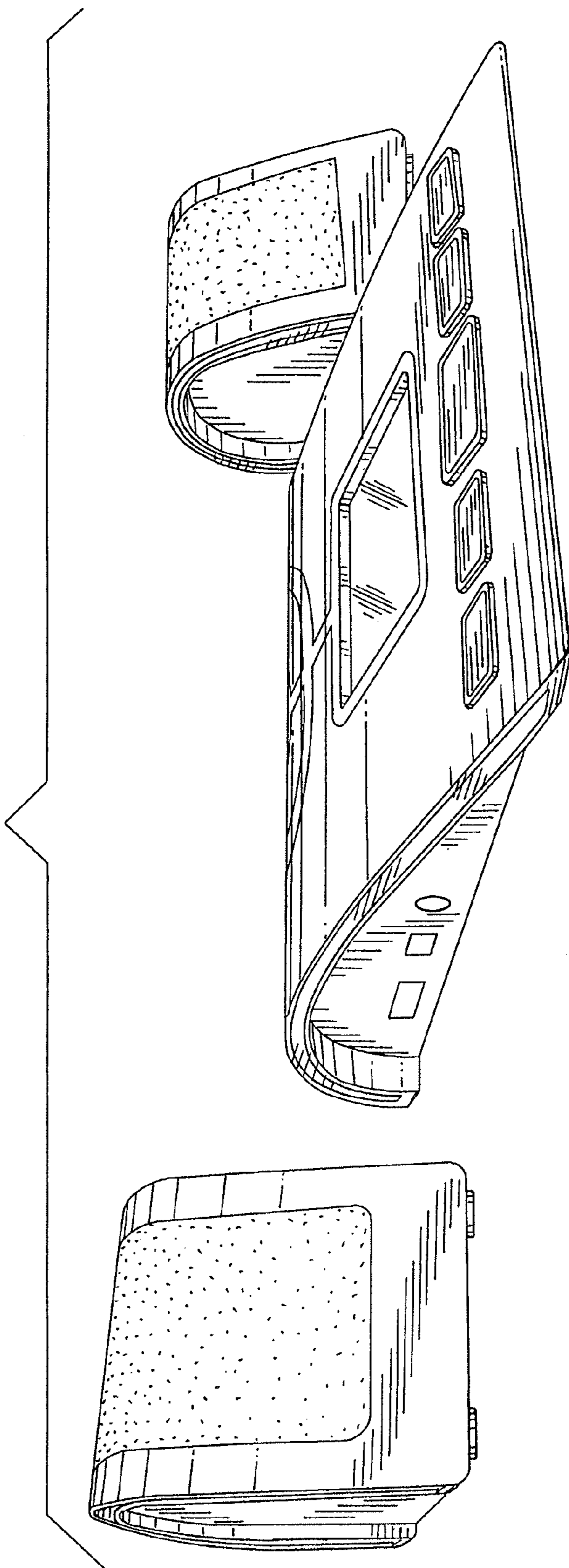

FIG. 2



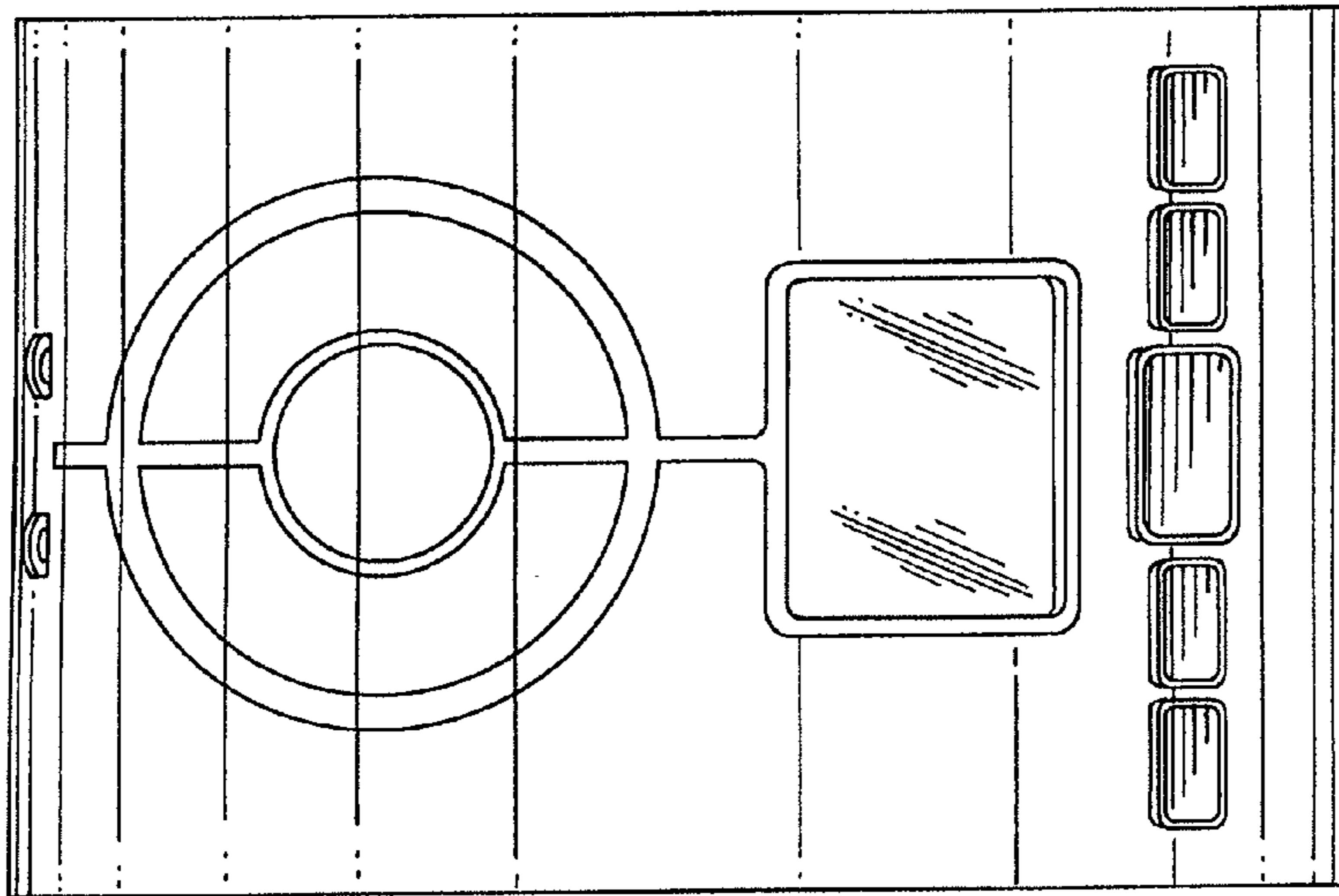

FIG. 3

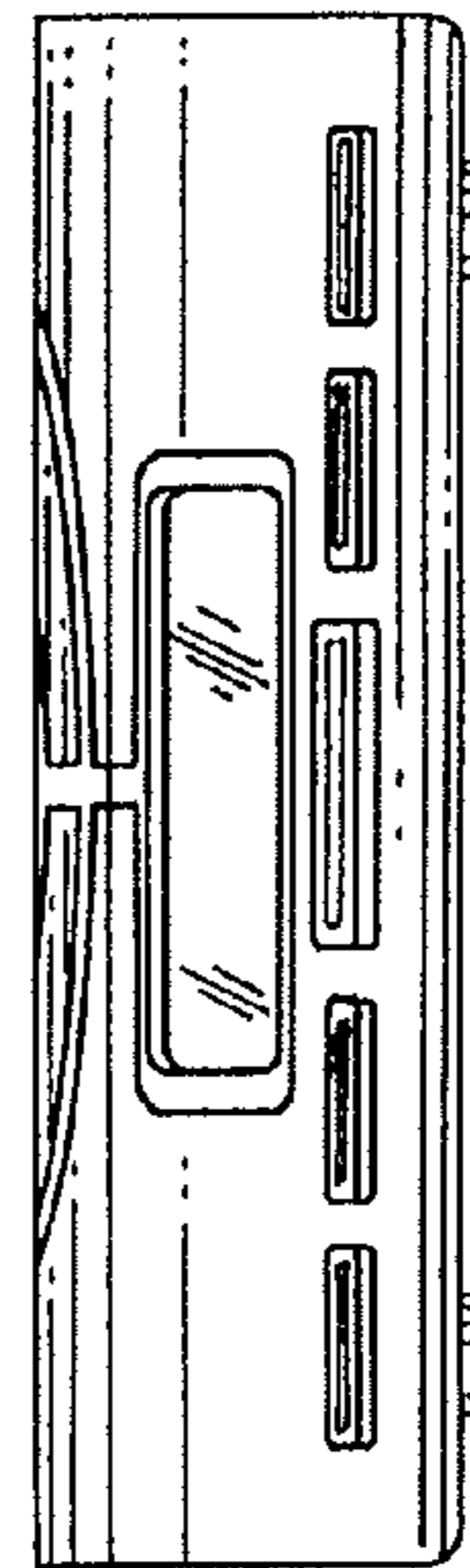

FIG. 4

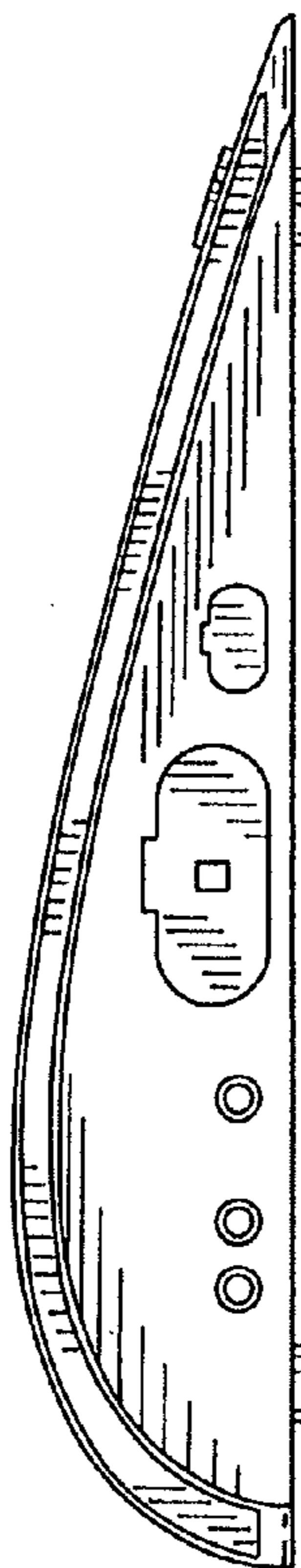

FIG. 8

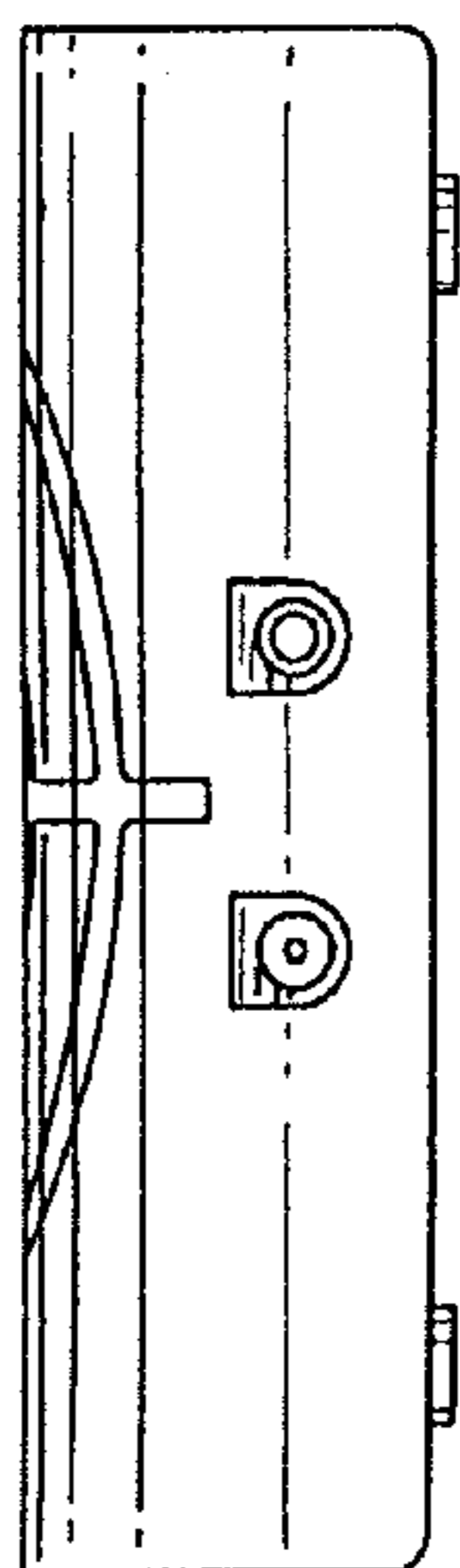

FIG. 5

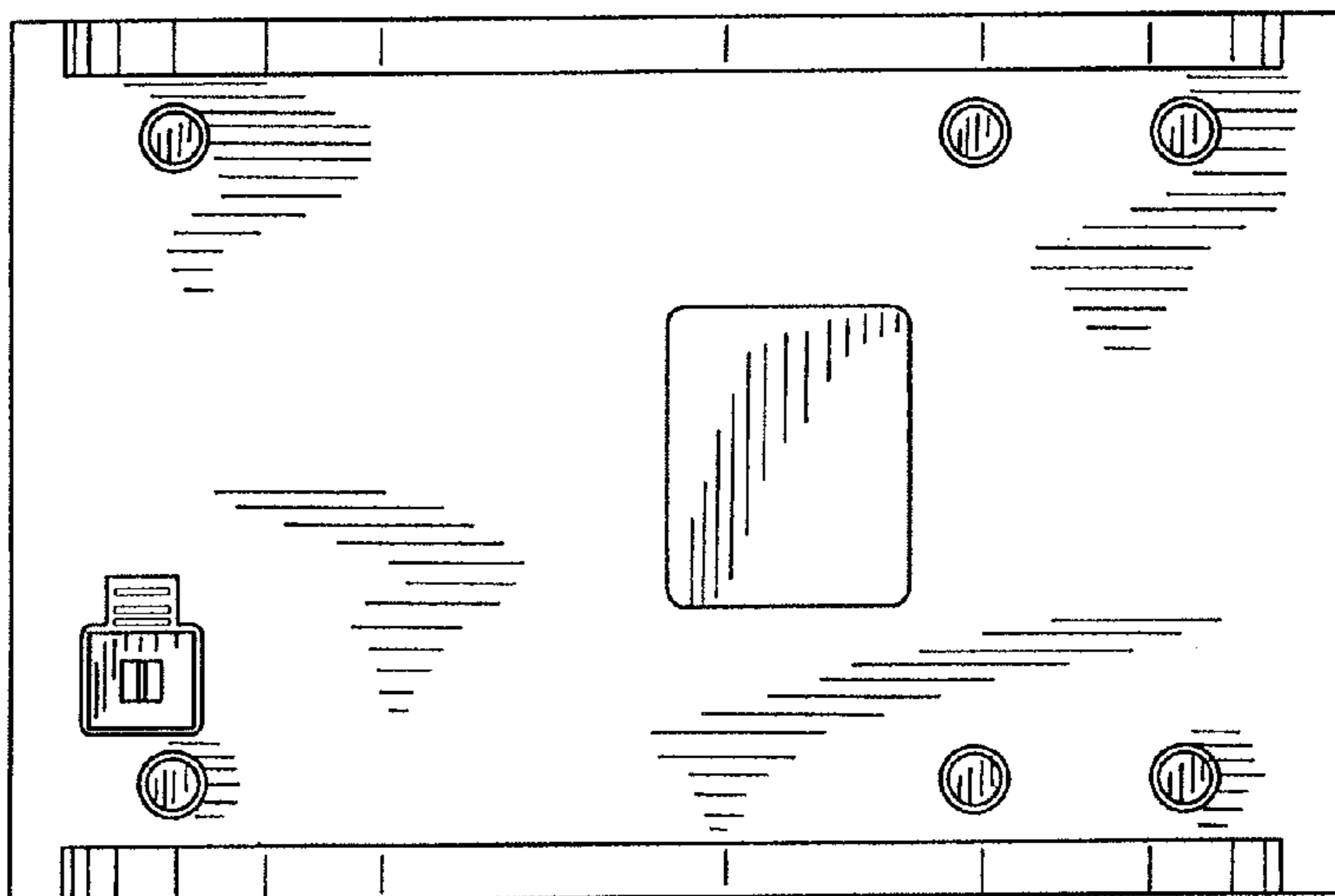

FIG. 6

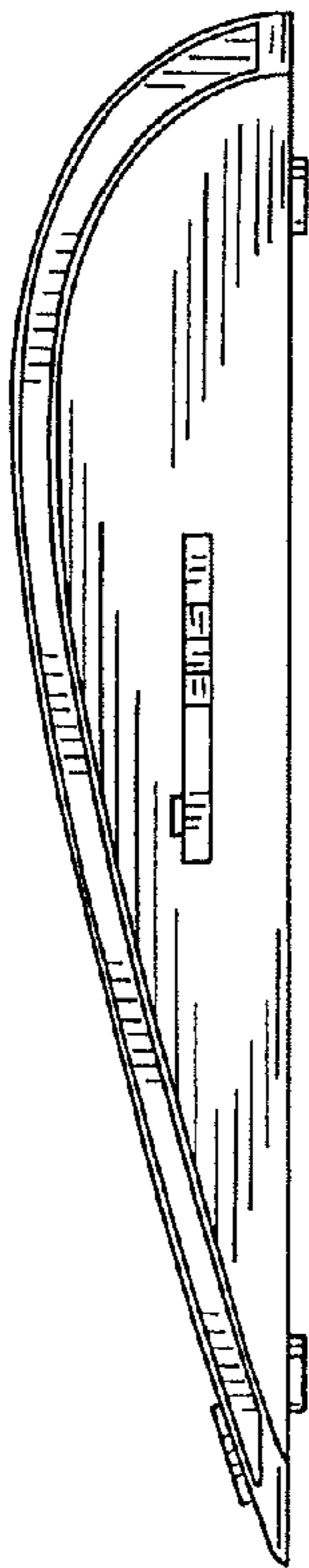

FIG. 7

FIG. 9

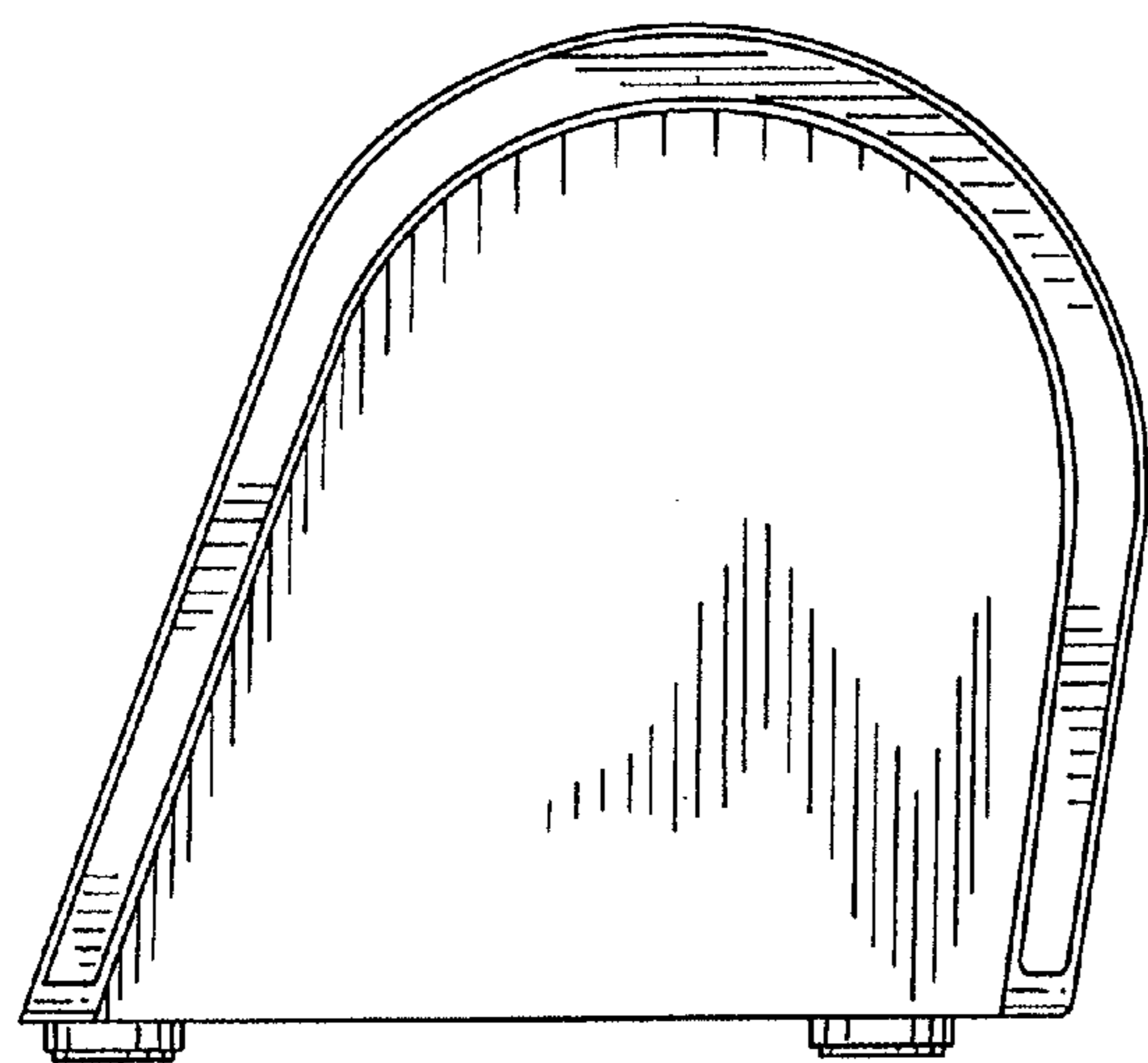
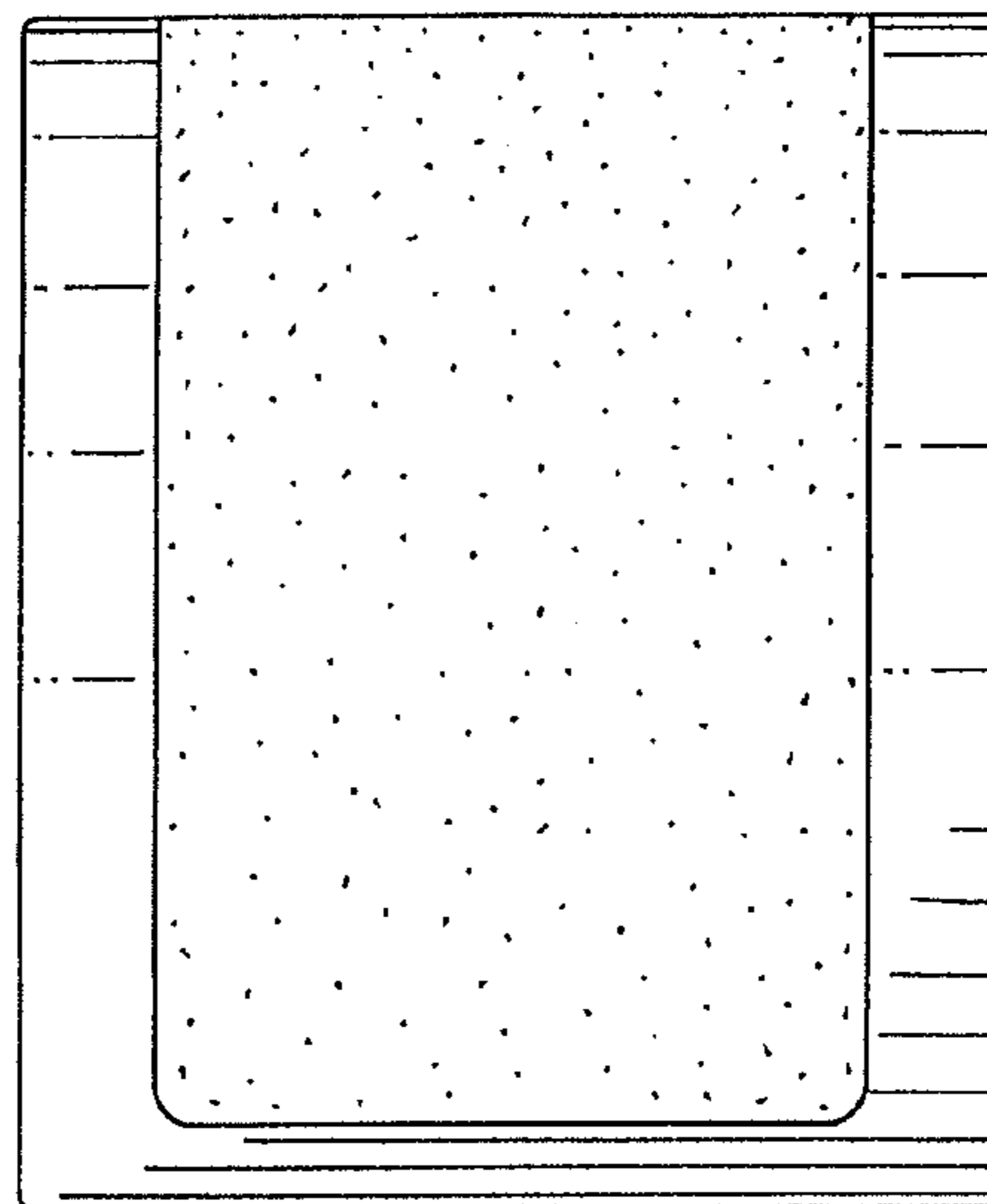

FIG. 14

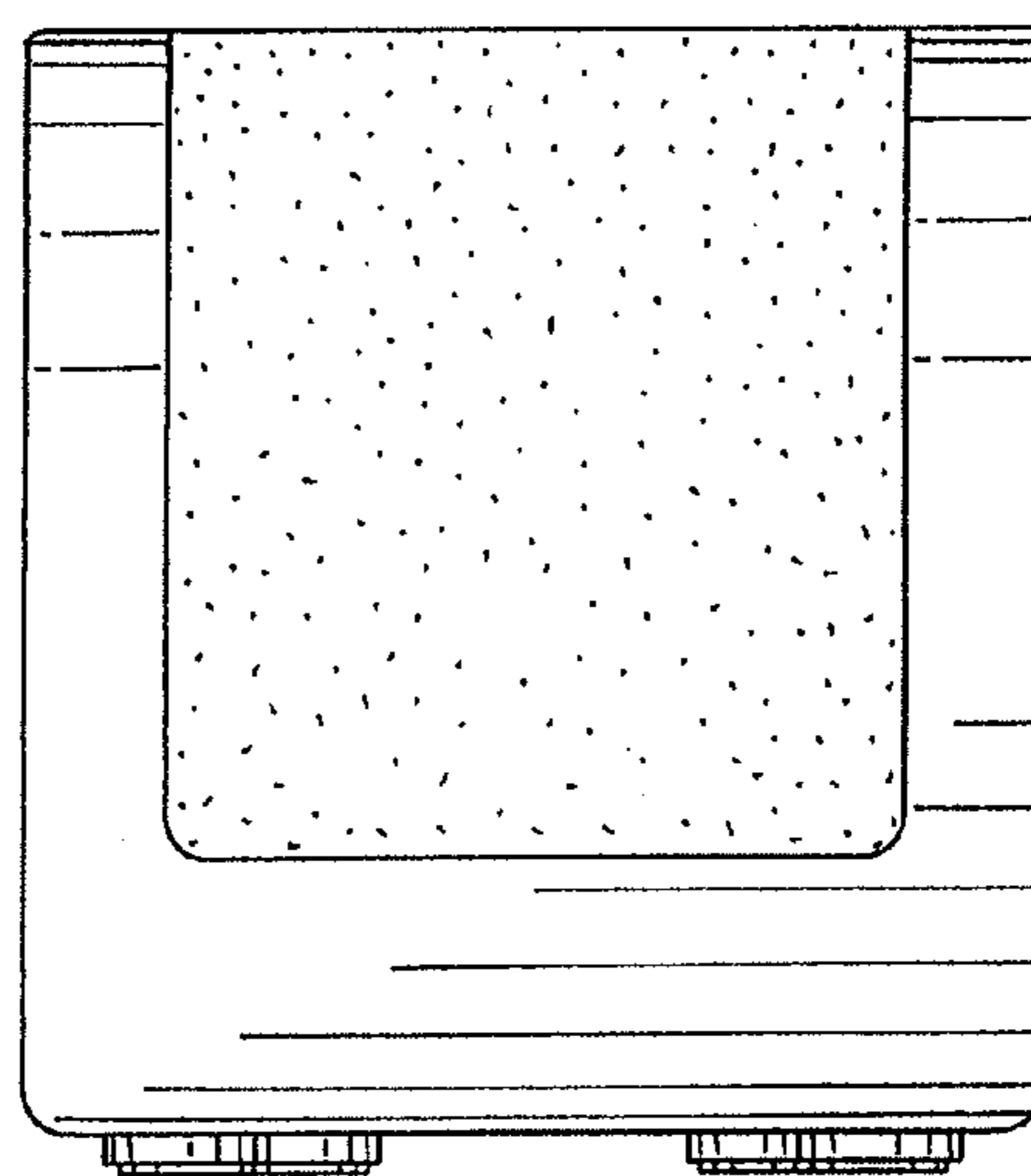

FIG. 10

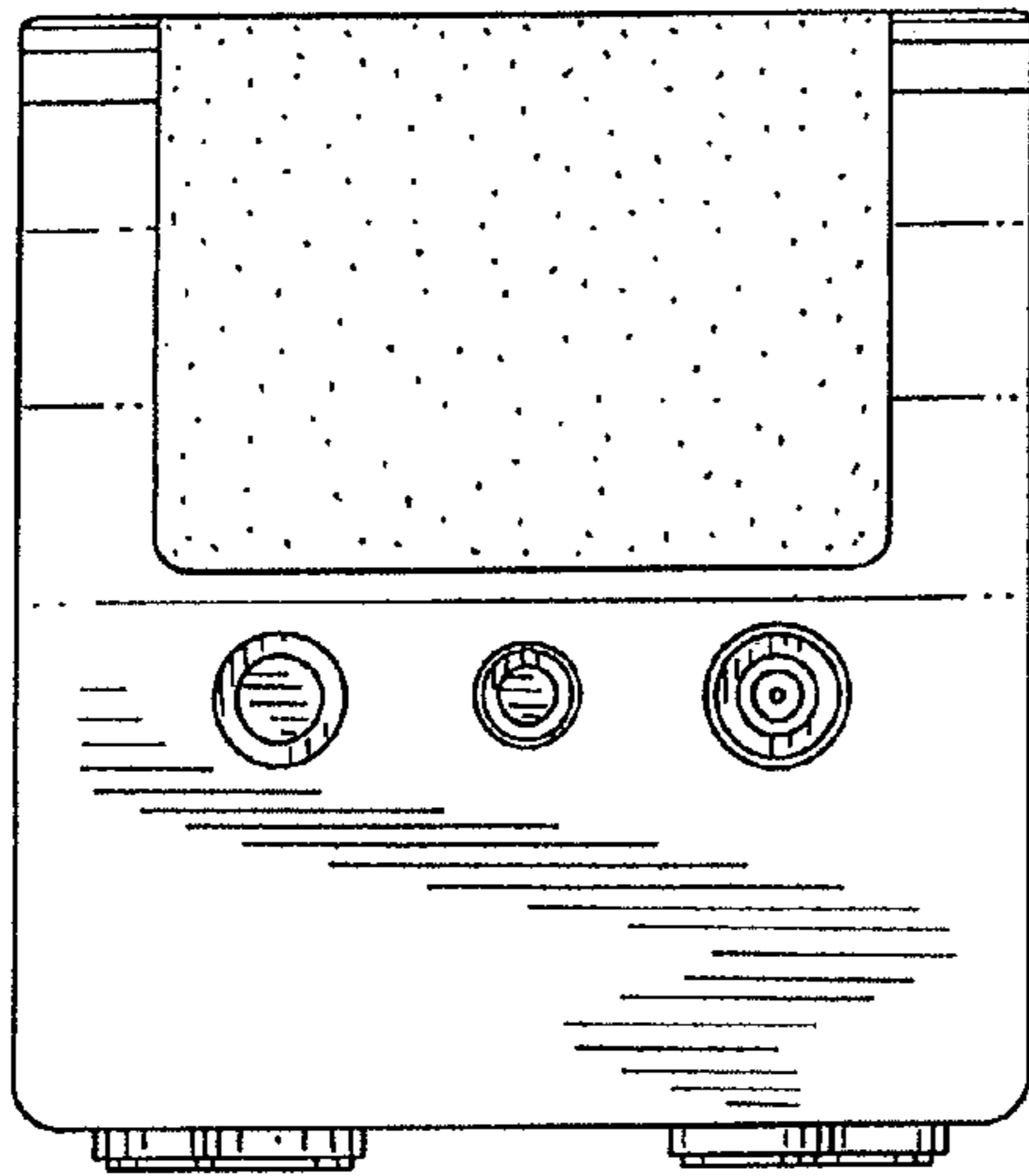

FIG. 11

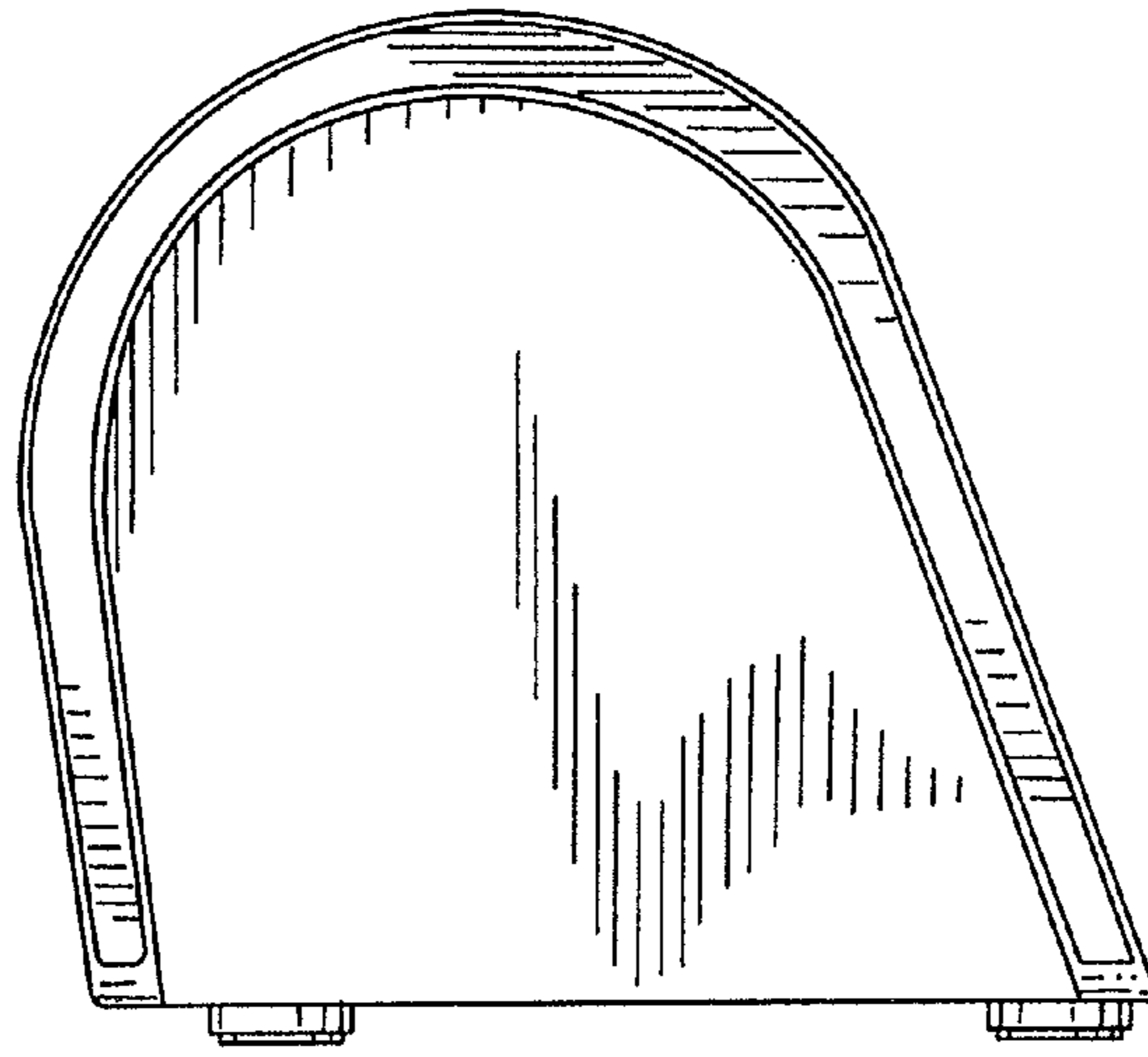

FIG. 13

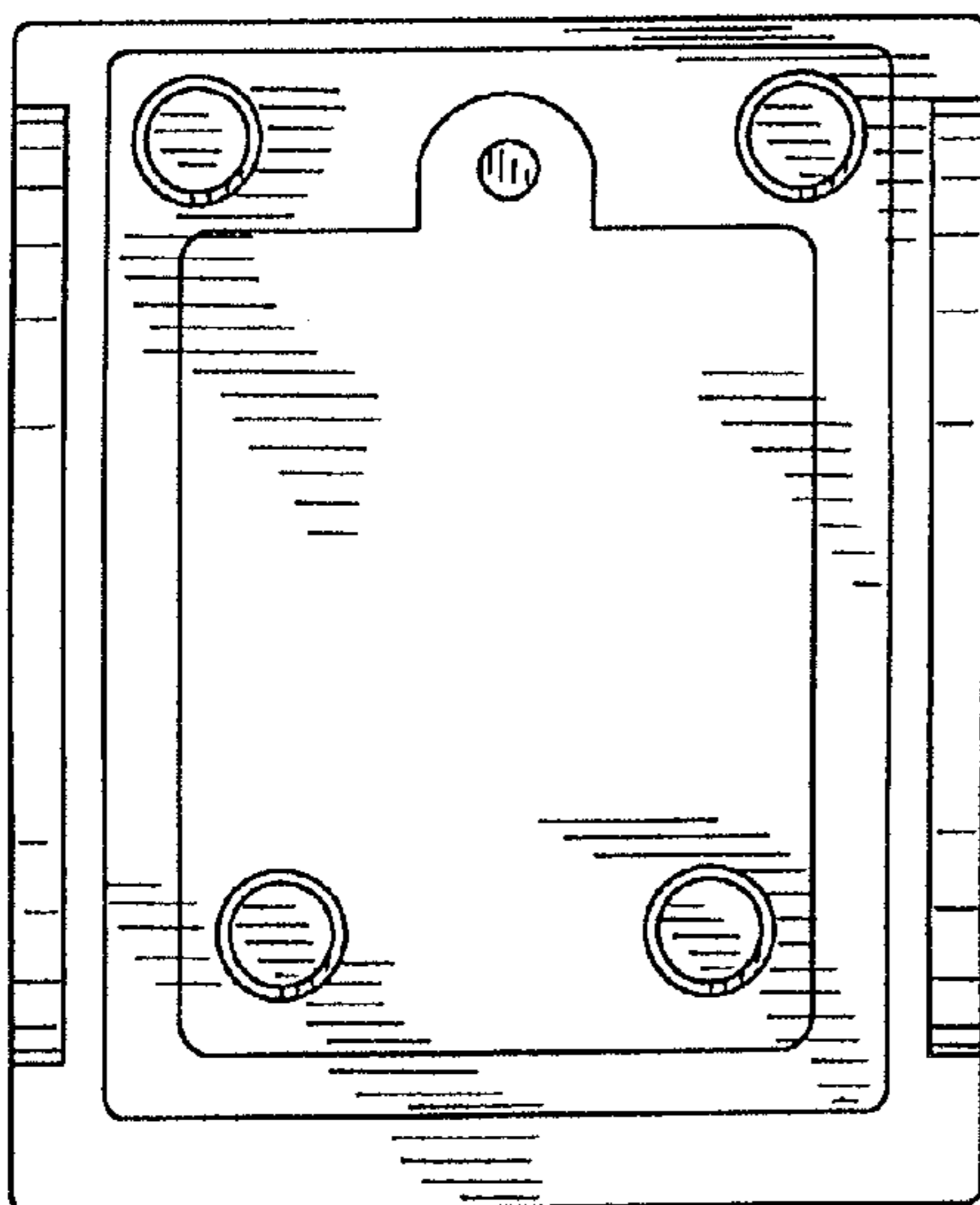

FIG. 12

UNITED STATES PATENT AND TRADEMARK OFFICE
CERTIFICATE OF CORRECTION

PATENT NO. : D680,515 S
APPLICATION NO. : 29/396597
DATED : April 23, 2013
INVENTOR(S) : Gilles Beeckmans et al.

Page 1 of 1

It is certified that error appears in the above-identified patent and that said Letters Patent is hereby corrected as shown below:

On the Title Page

replace: (73) Assignee: Gingo Biloba,S.A., Hong Kong (HK)

with

(73) Assignee: Cambridge Sound Technologies Limited, Hong Kong (HK)

Signed and Sealed this
Fourth Day of August, 2015



Michelle K. Lee
Director of the United States Patent and Trademark Office