



US00D680497S

(12) **United States Design Patent**  
**Lan et al.**

(10) **Patent No.:** **US D680,497 S**  
(45) **Date of Patent:** **\*\* Apr. 23, 2013**

(54) **CABLE CONNECTOR**

(75) Inventors: **Rong-Qin Lan**, Guang-Dong (CN);  
**Li-Jun Xu**, Guang-Dong (CN);  
**Ming-Han Lin**, New Taipei (TW)

(73) Assignee: **Cheng UEI Precision Industry Co., Ltd.**, New Taipei (TW)

(\*\*) Term: **14 Years**

(21) Appl. No.: **29/399,799**

(22) Filed: **Aug. 18, 2011**

(51) **LOC (9) Cl.** ..... **13-03**

(52) **U.S. Cl.**  
USPC ..... **D13/147**

(58) **Field of Classification Search** ..... D13/147,  
D13/154, 184, 199; 439/79, 108, 350, 353,  
439/357, 358, 378, 447, 578, 567, 595, 607.01,  
439/607.04, 607.05, 607.17, 607.25, 607.34,  
439/607.41, 607.53, 660, 668, 677, 680-682,  
439/686

See application file for complete search history.

(56) **References Cited**

U.S. PATENT DOCUMENTS

D503,683	S	*	4/2005	Wang	.....	D13/147
D551,627	S	*	9/2007	Chang et al.	.....	D13/147
D563,875	S	*	3/2008	Chang et al.	.....	D13/147
D584,692	S	*	1/2009	Koyama et al.	.....	D13/147

\* cited by examiner

*Primary Examiner* — Daniel Bui

(74) *Attorney, Agent, or Firm* — Cheng-Ju Chiang

(57) **CLAIM**

The ornamental design for a cable connector, as shown and described.

**DESCRIPTION**

FIG. 1 is a perspective view of a cable connector showing our new design;

FIG. 2 is a front elevational view thereof;

FIG. 3 is a rear elevational view thereof;

FIG. 4 is a left side elevational view thereof;

FIG. 5 is a right side elevational view thereof;

FIG. 6 is a top plan view thereof;

FIG. 7 is a bottom plan view thereof; and,

FIG. 8 is another perspective view of the cable connector showing our new design.

The broken line portion of the figure drawings is included to show unclaimed subject matter only and forms no part of the claimed design.

**1 Claim, 8 Drawing Sheets**

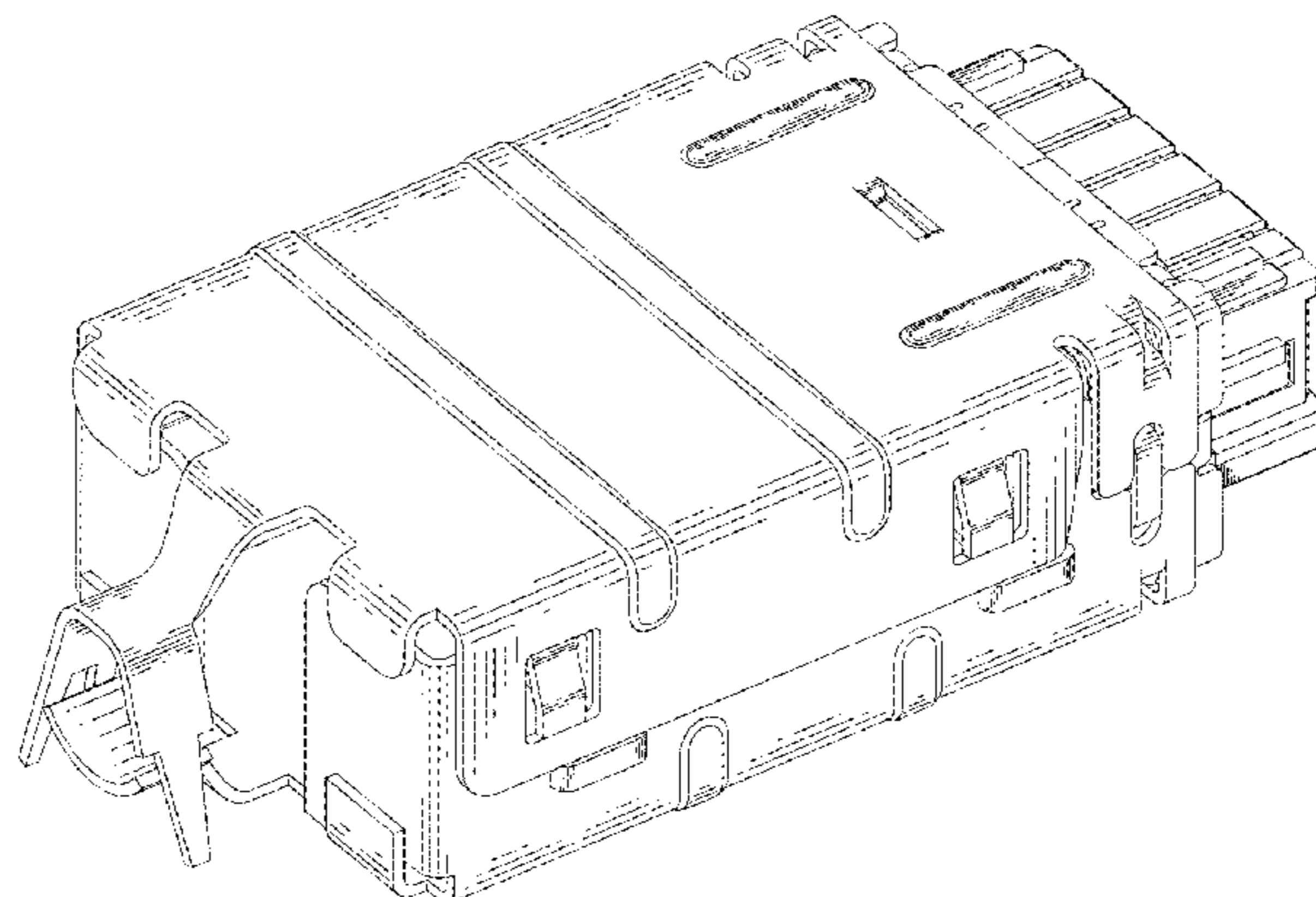
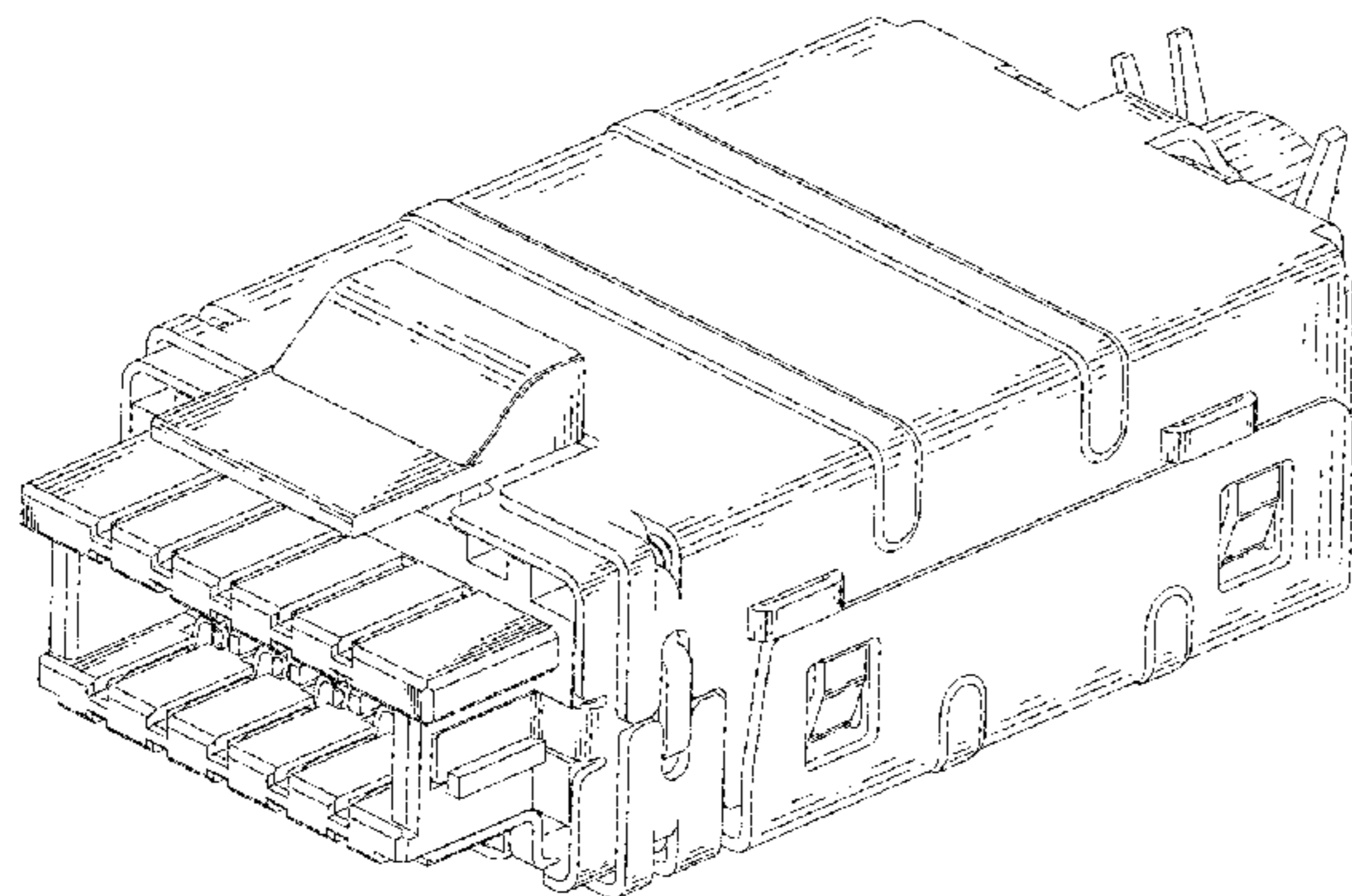

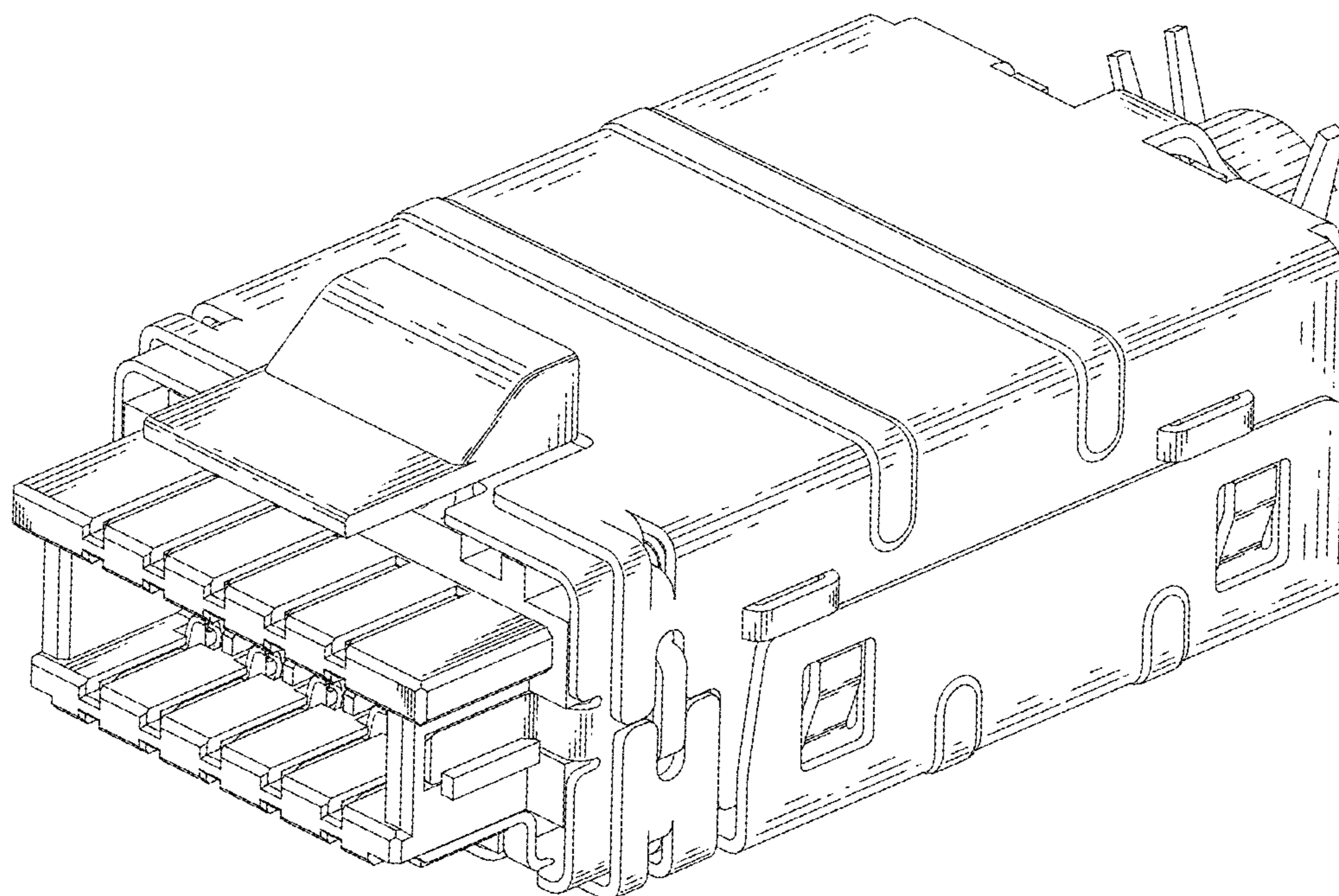

FIG. 1

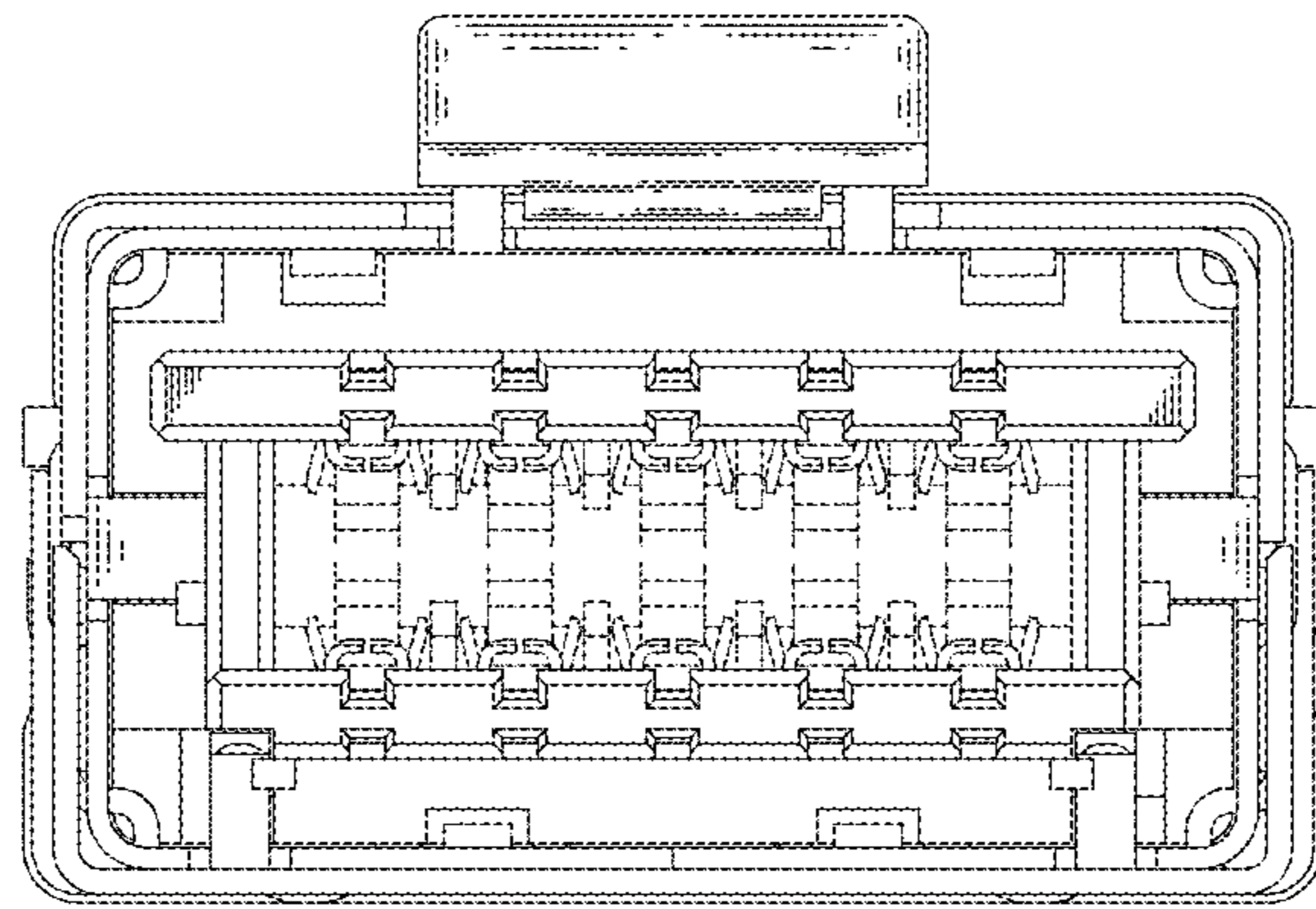

FIG. 2

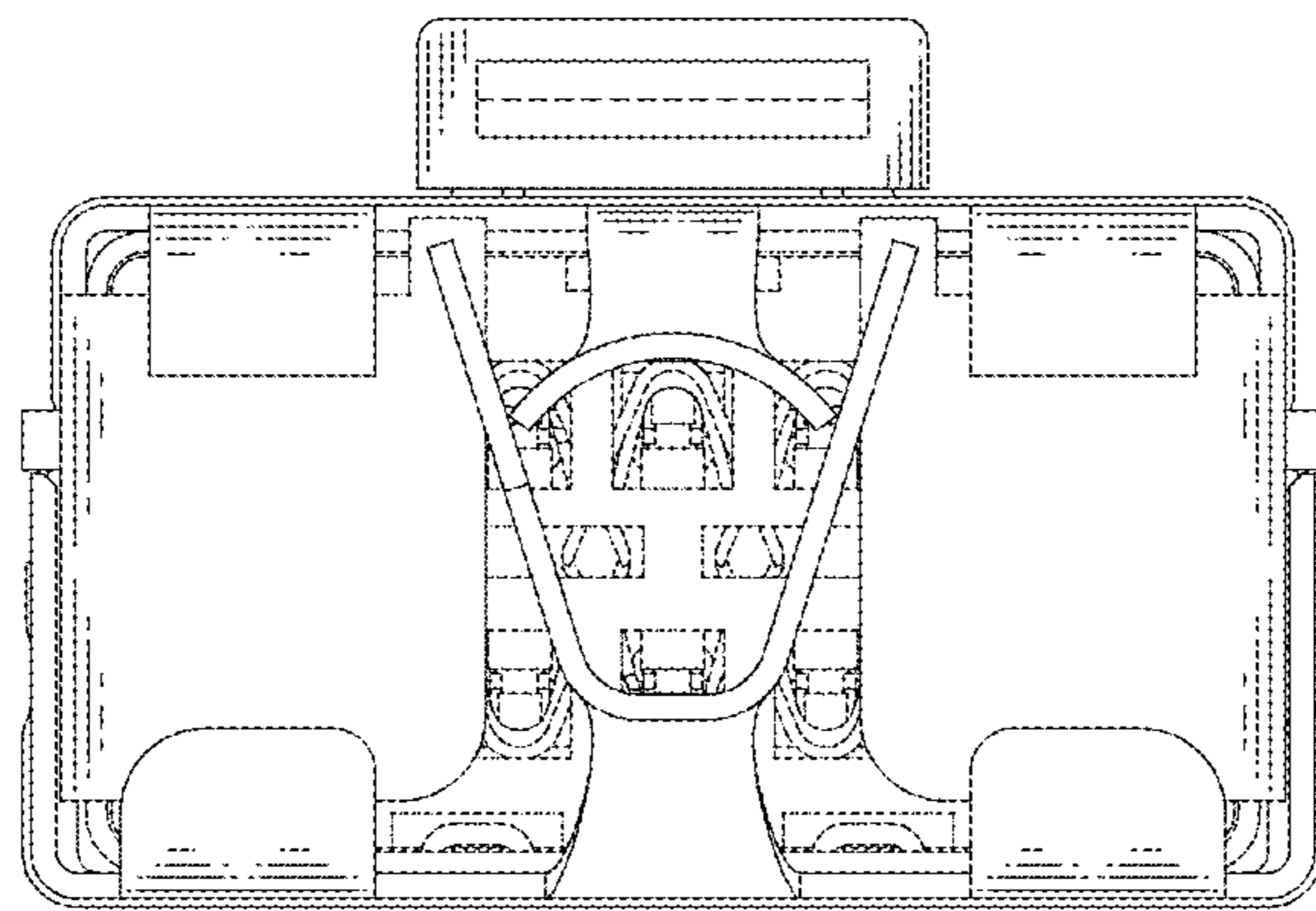

FIG. 3

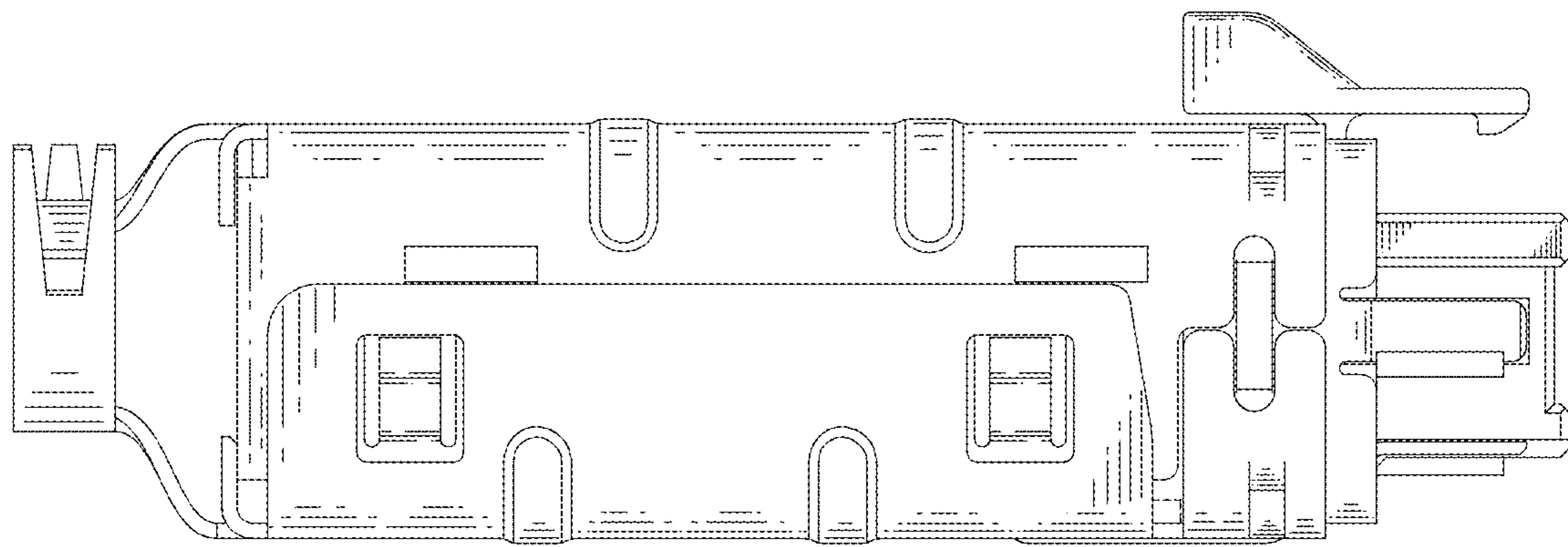

FIG. 4

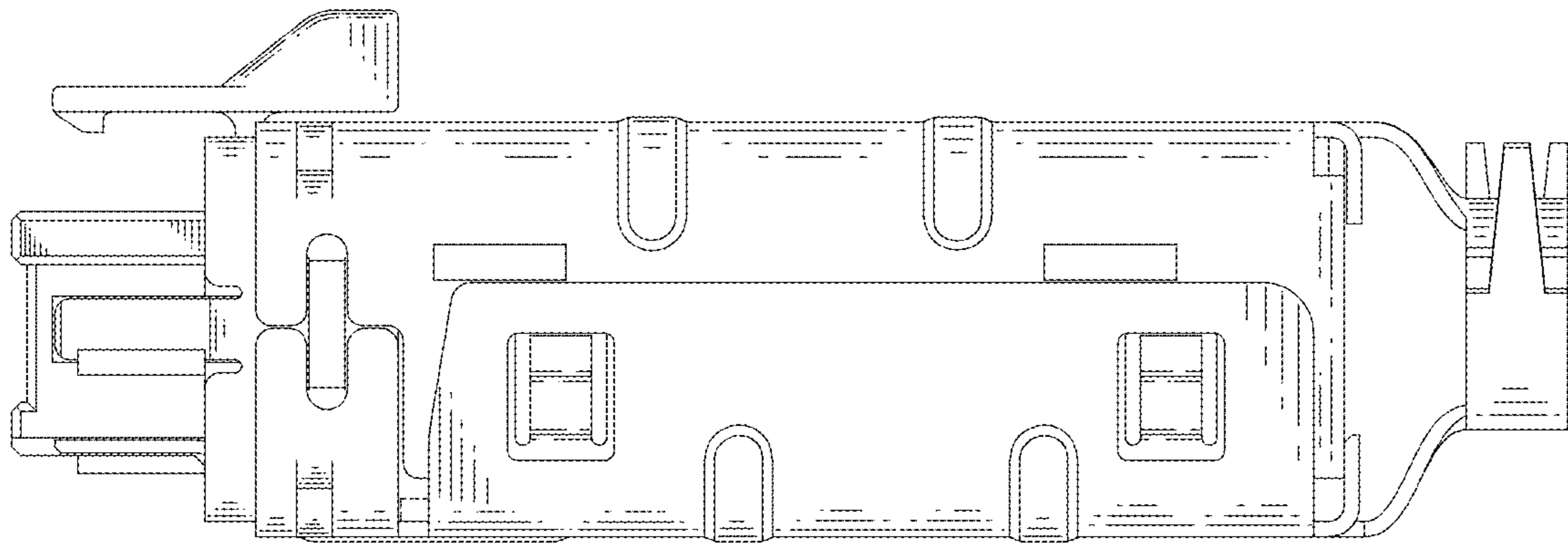

FIG. 5

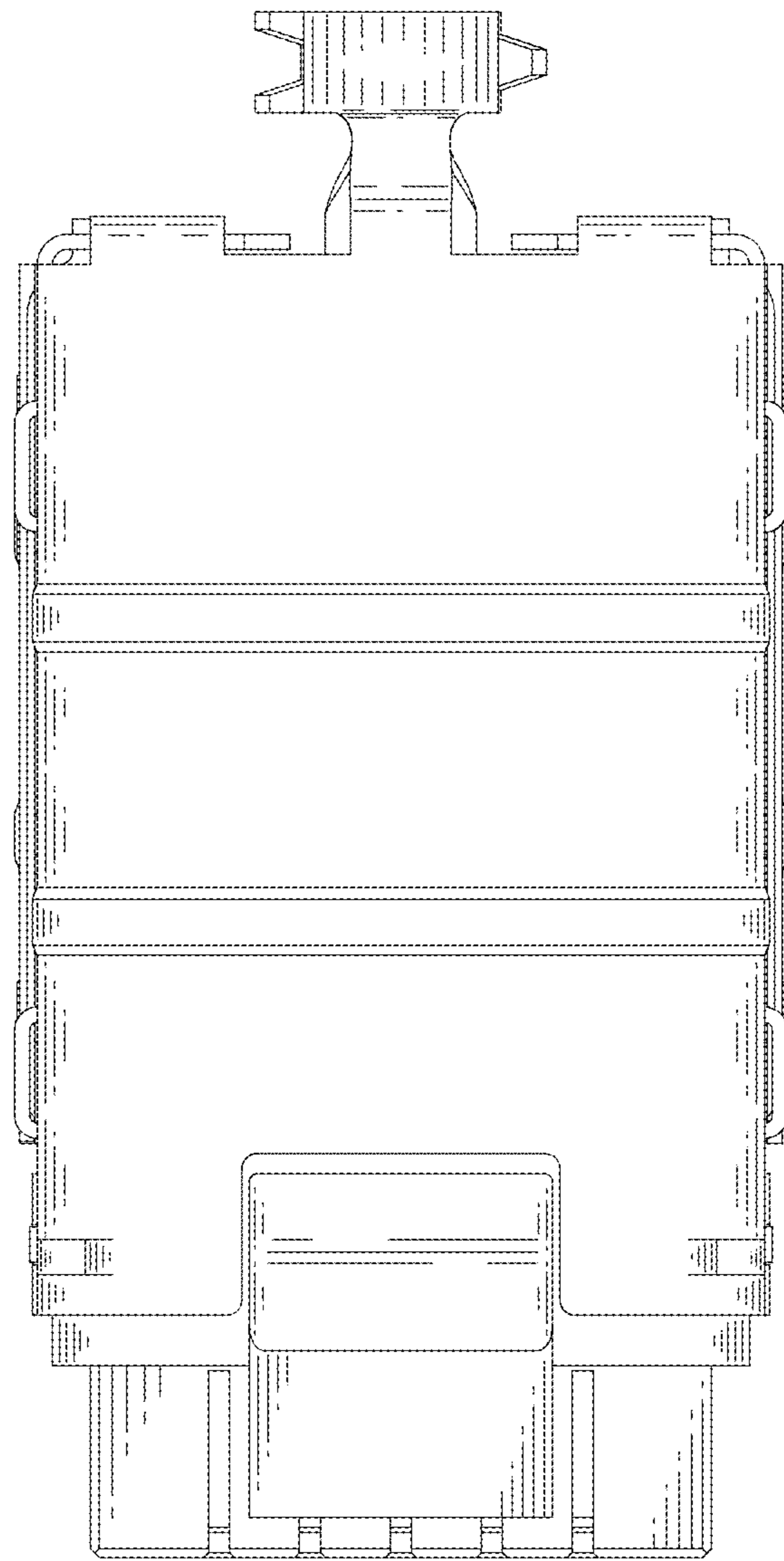

FIG. 6

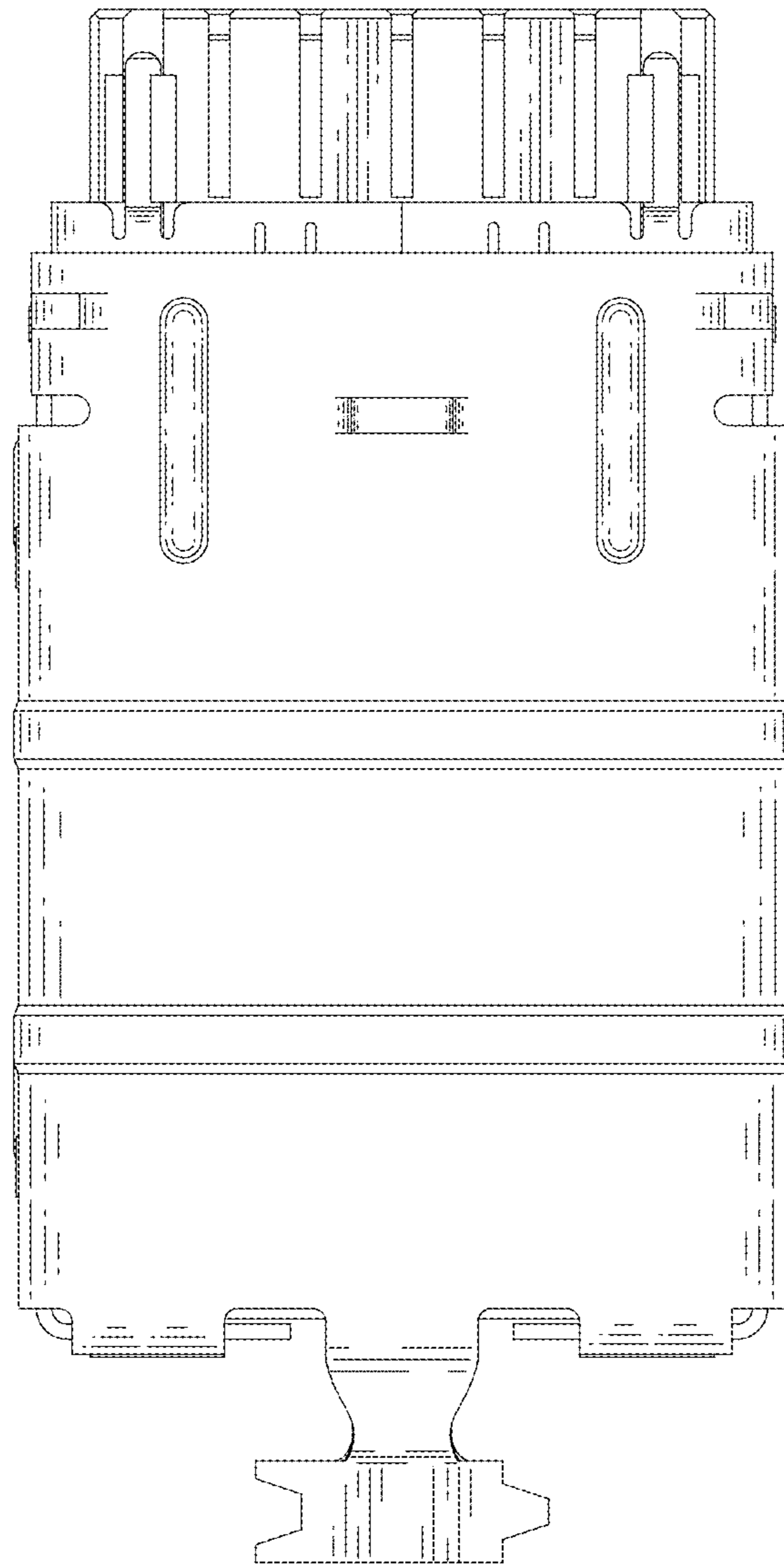

FIG. 7



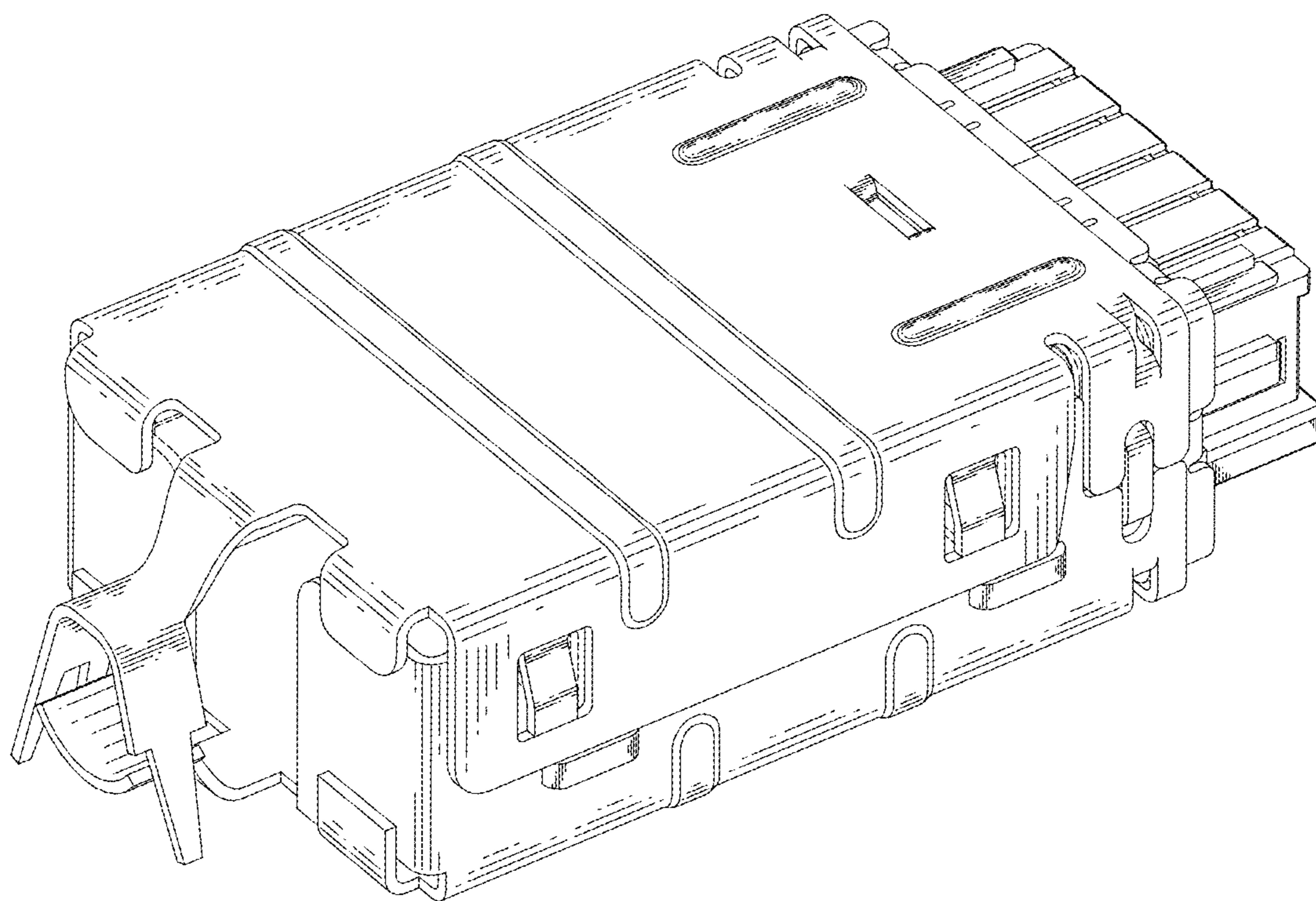

FIG. 8