



US00D680441S

(12) **United States Design Patent**
Herbst

(10) **Patent No.:** **US D680,441 S**

(45) **Date of Patent:** **** Apr. 23, 2013**

(54) **BOTTLE**

(75) Inventor: **Andrew F. Herbst**, Copperopolis, CA
(US)

(73) Assignee: **RNR IP Holdings, LLC**, Stockton, CA
(US)

(**) Term: **14 Years**

(21) Appl. No.: **29/405,798**

(22) Filed: **Nov. 7, 2011**

(51) **LOC (9) Cl.** **09-01**

(52) **U.S. Cl.**

USPC **D9/665**

(58) **Field of Classification Search** D7/514-515,
D7/606, 613, 628; D9/600, 655, 516, 414,
D9/424; 206/457, 527, 540; 220/890
See application file for complete search history.

(56) **References Cited**

U.S. PATENT DOCUMENTS

D300,408 S *	3/1989	Couri	D9/665
D440,487 S	4/2001	Leach		
D440,869 S *	4/2001	Leach	D9/665
D442,476 S *	5/2001	Davis	D9/665
D499,961 S *	12/2004	Wilson	D9/665

D604,179 S *	11/2009	Rodriguez	D9/665
D619,476 S *	7/2010	McClellan et al.	D9/665
2004/0069671 A1 *	4/2004	Lam et al.	206/457

* cited by examiner

Primary Examiner — Sandra Morris

(74) *Attorney, Agent, or Firm* — Maier & Maier PLLC

(57) **CLAIM**

The ornamental design for a bottle, as shown and described.

DESCRIPTION

FIG. 1 is a front isometric view of a first embodiment of a bottle, showing my design;
 FIG. 2 is a front view thereof;
 FIG. 3 is a rear view thereof;
 FIG. 4 is a left side view thereof;
 FIG. 5 is a right side view thereof;
 FIG. 6 is a top view thereof;
 FIG. 7 is a bottom view thereof;
 FIG. 8 is a front isometric view of a second embodiment of a bottle, the only difference being that the bottle is transparent;
 FIG. 9 is a front view thereof;
 FIG. 10 is a rear view thereof;
 FIG. 11 is a left side view thereof;
 FIG. 12 is a right side view thereof;
 FIG. 13 is a top view thereof; and,
 FIG. 14 is a bottom view thereof.

1 Claim, 8 Drawing Sheets

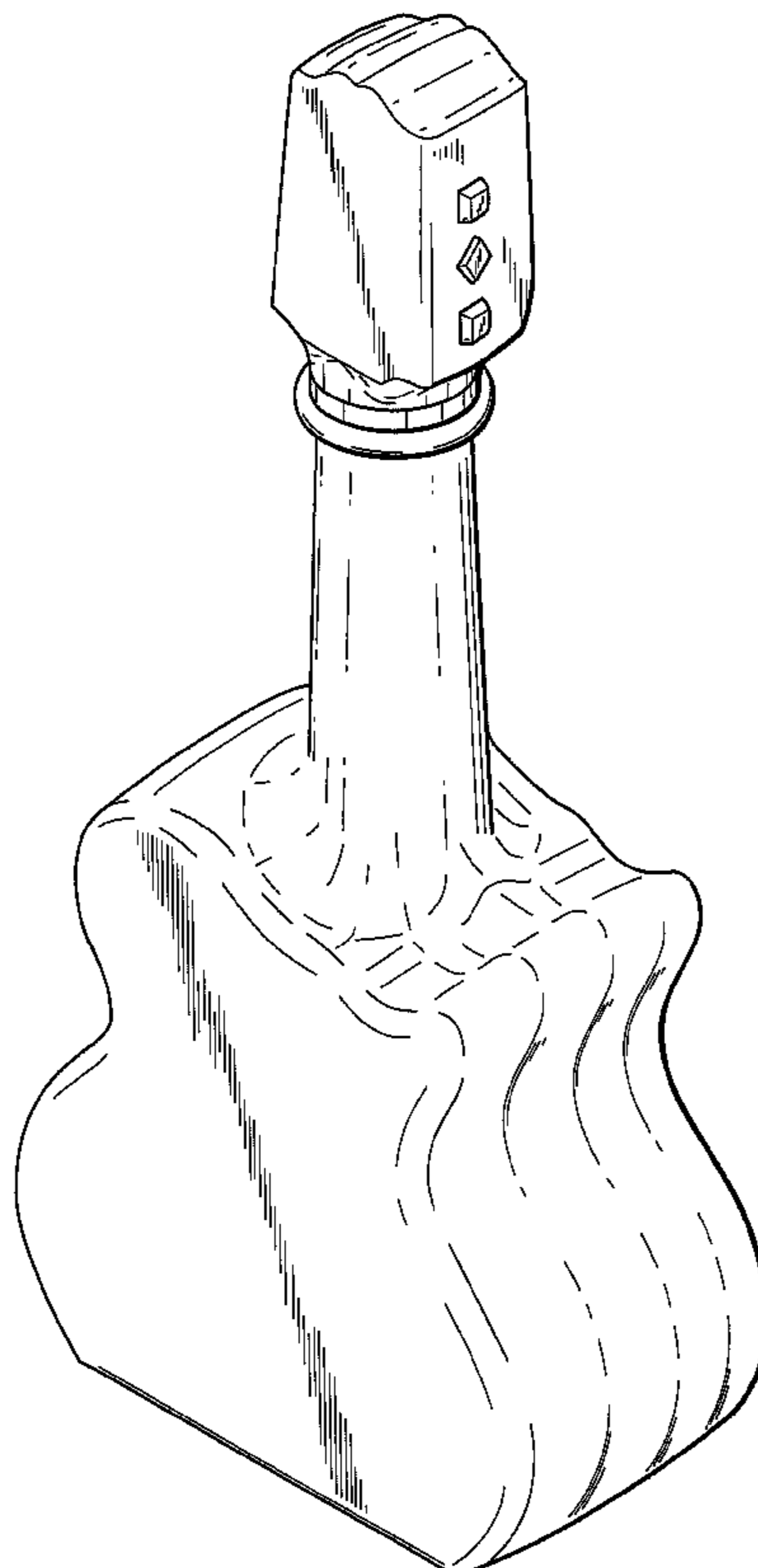

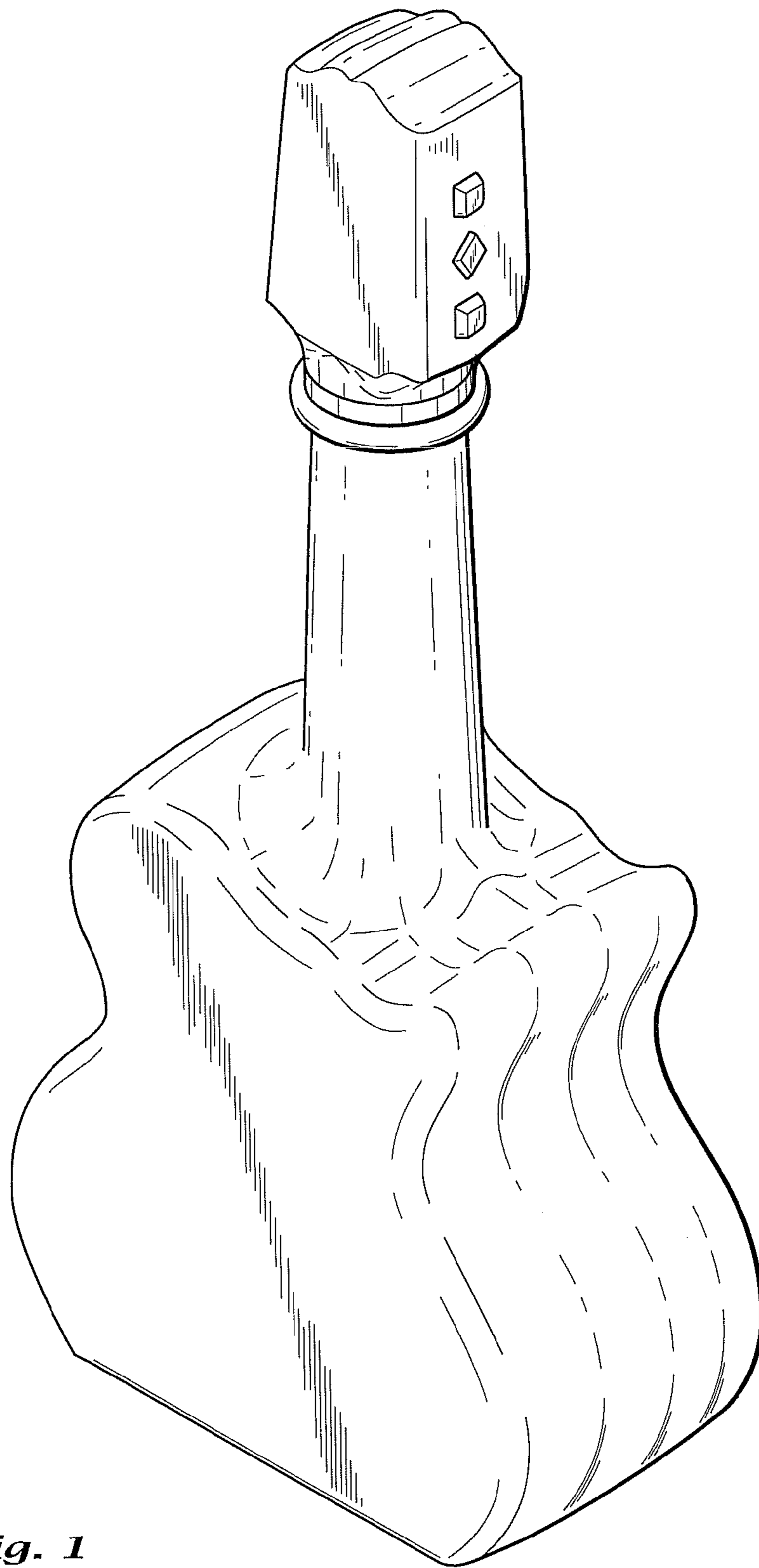

Fig. 1

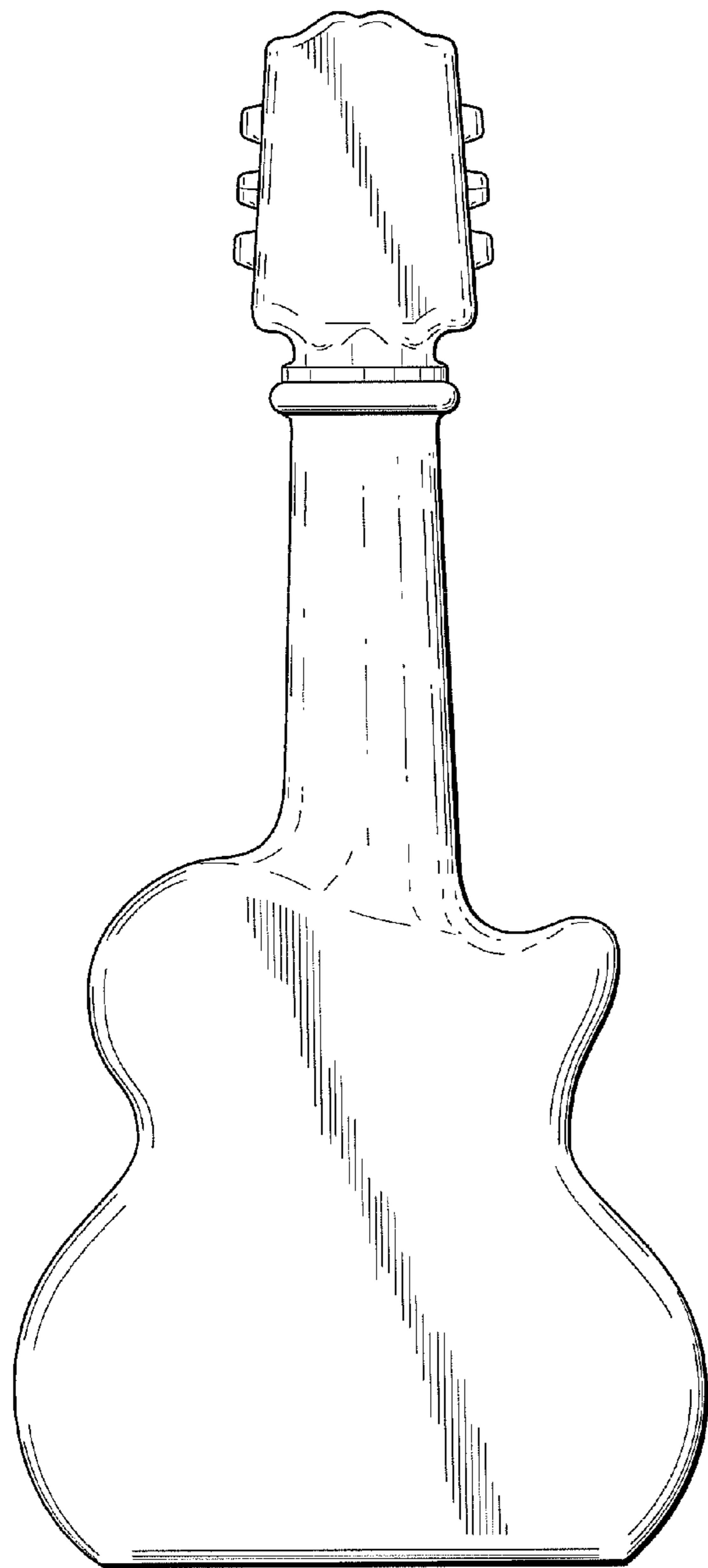

Fig. 2

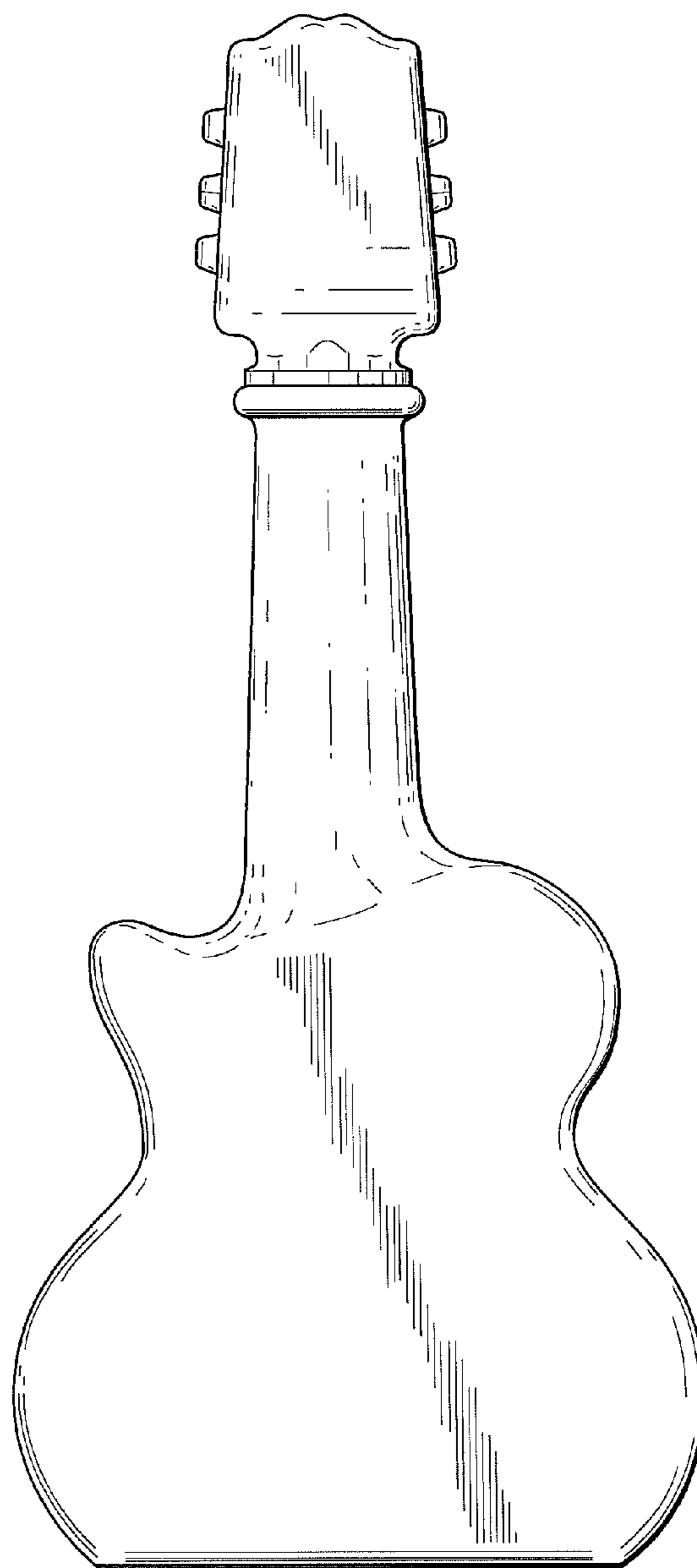

Fig. 3

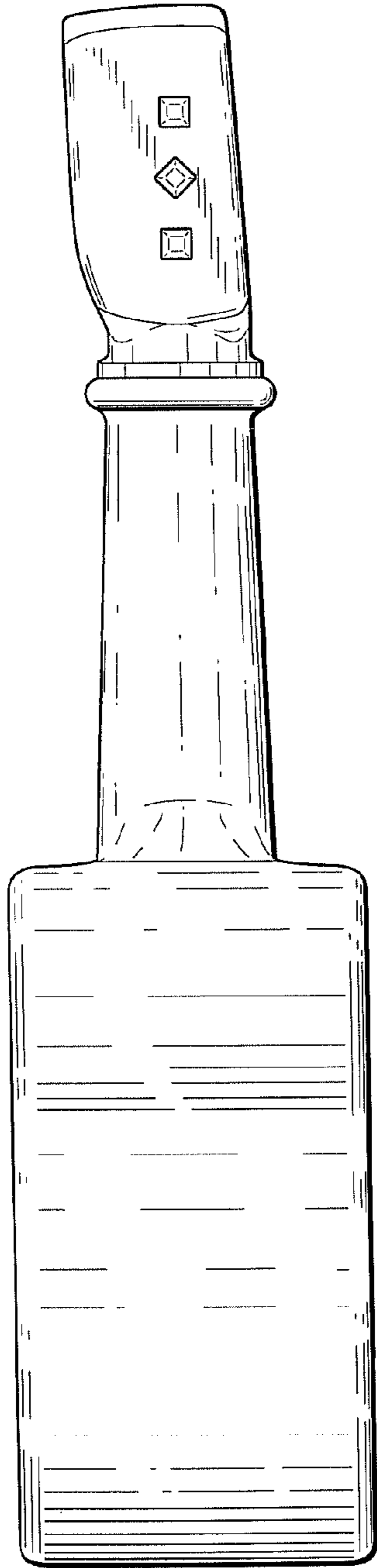

Fig. 4

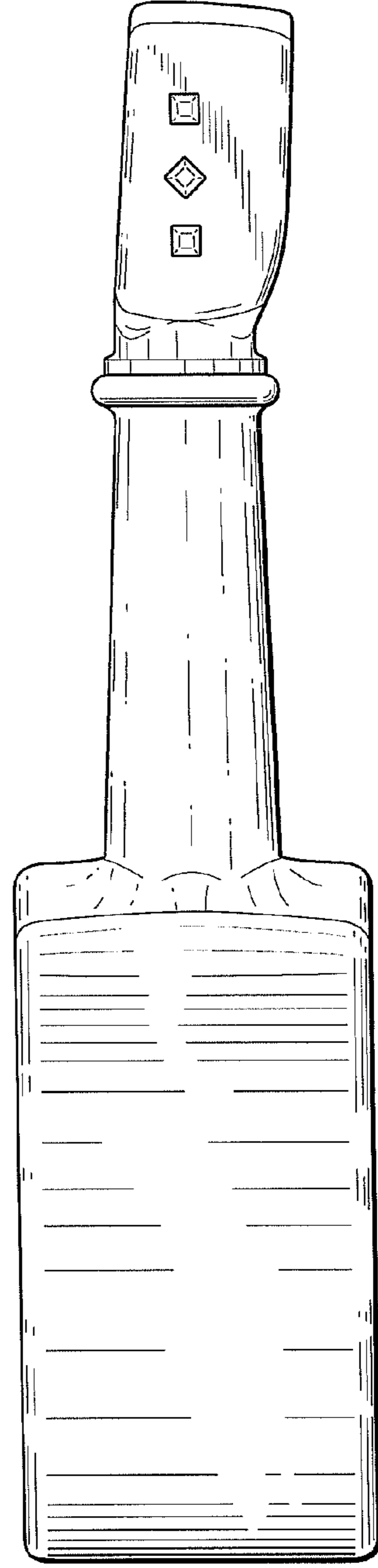

Fig. 5

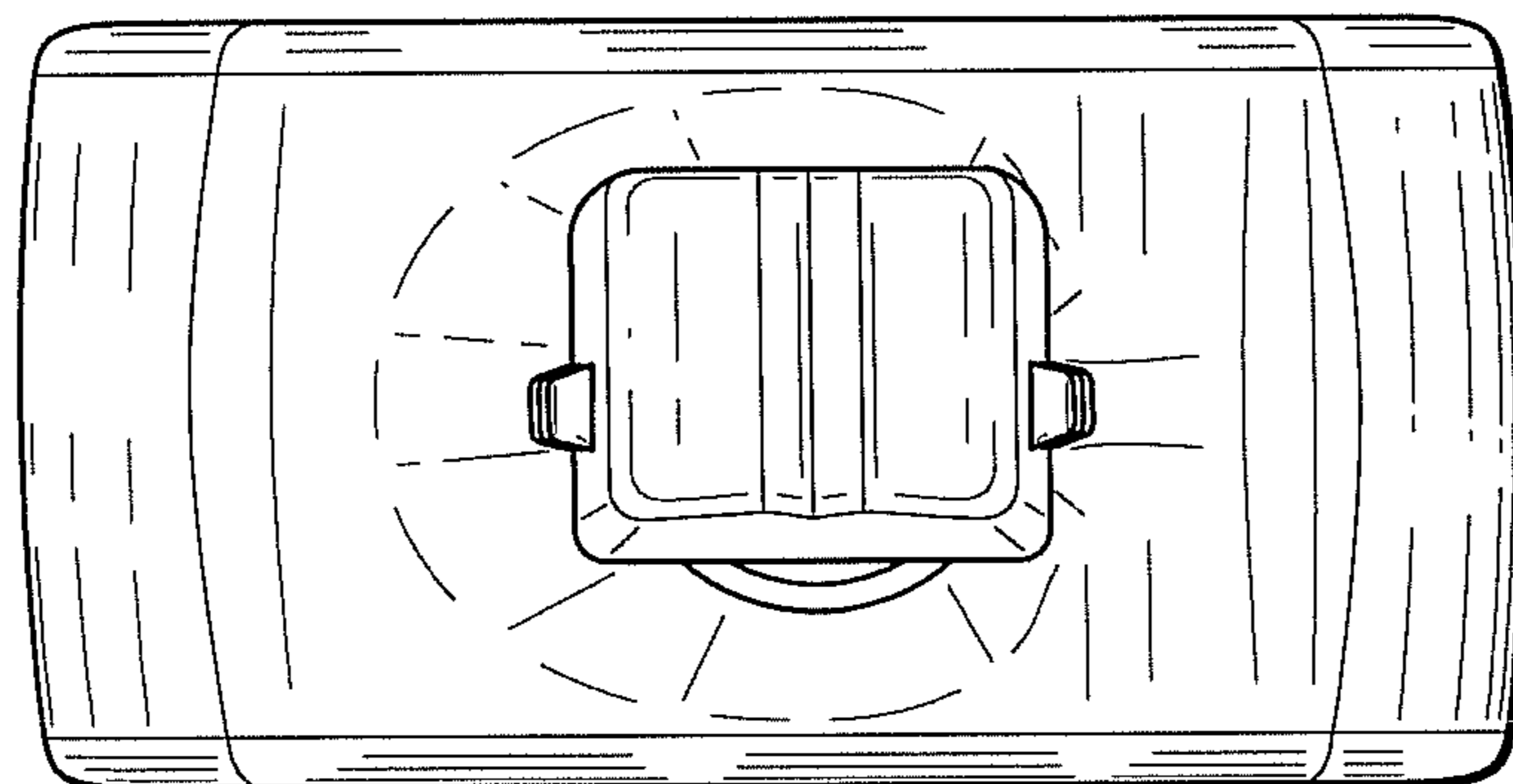

Fig. 6

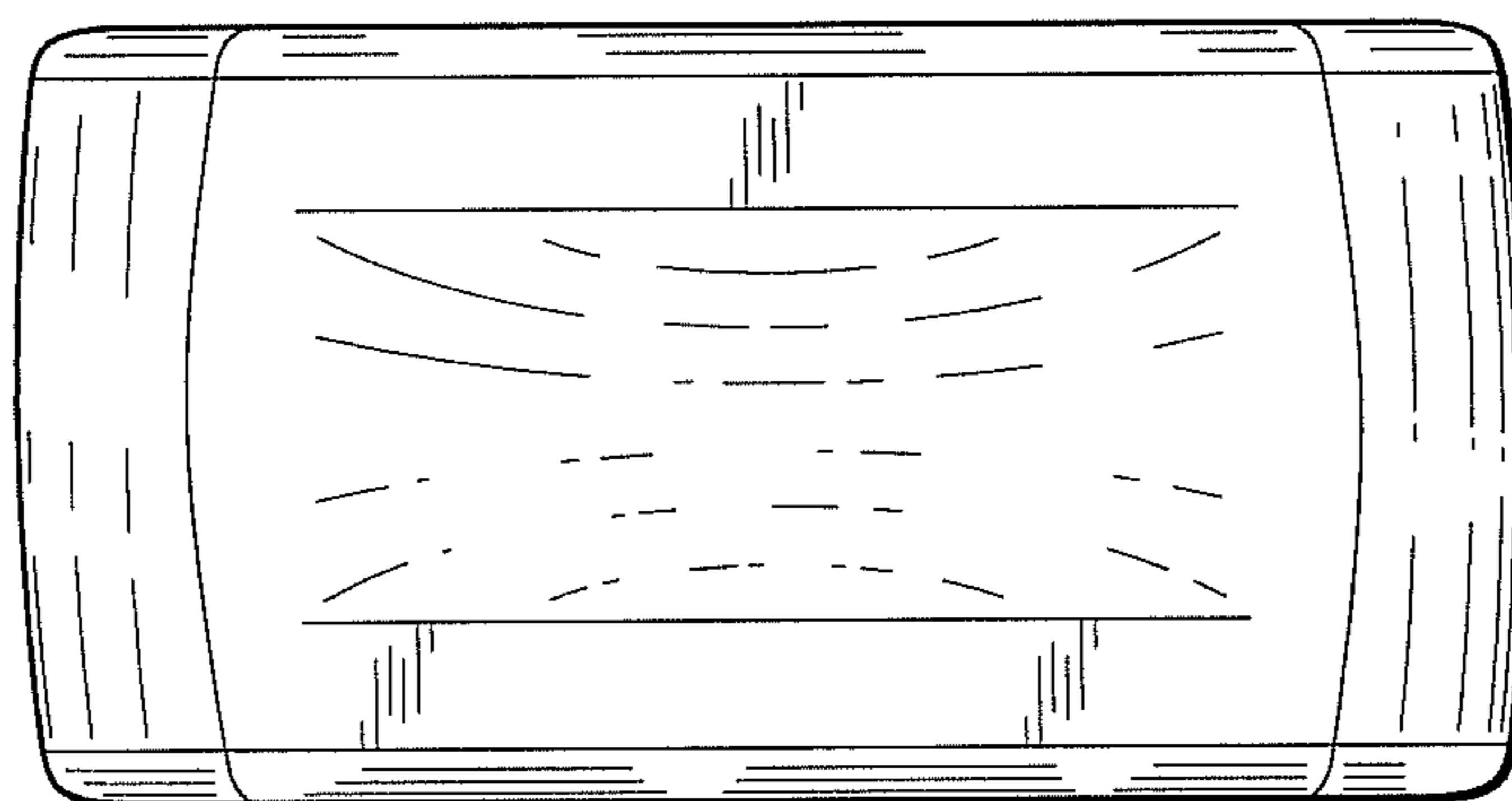

Fig. 7

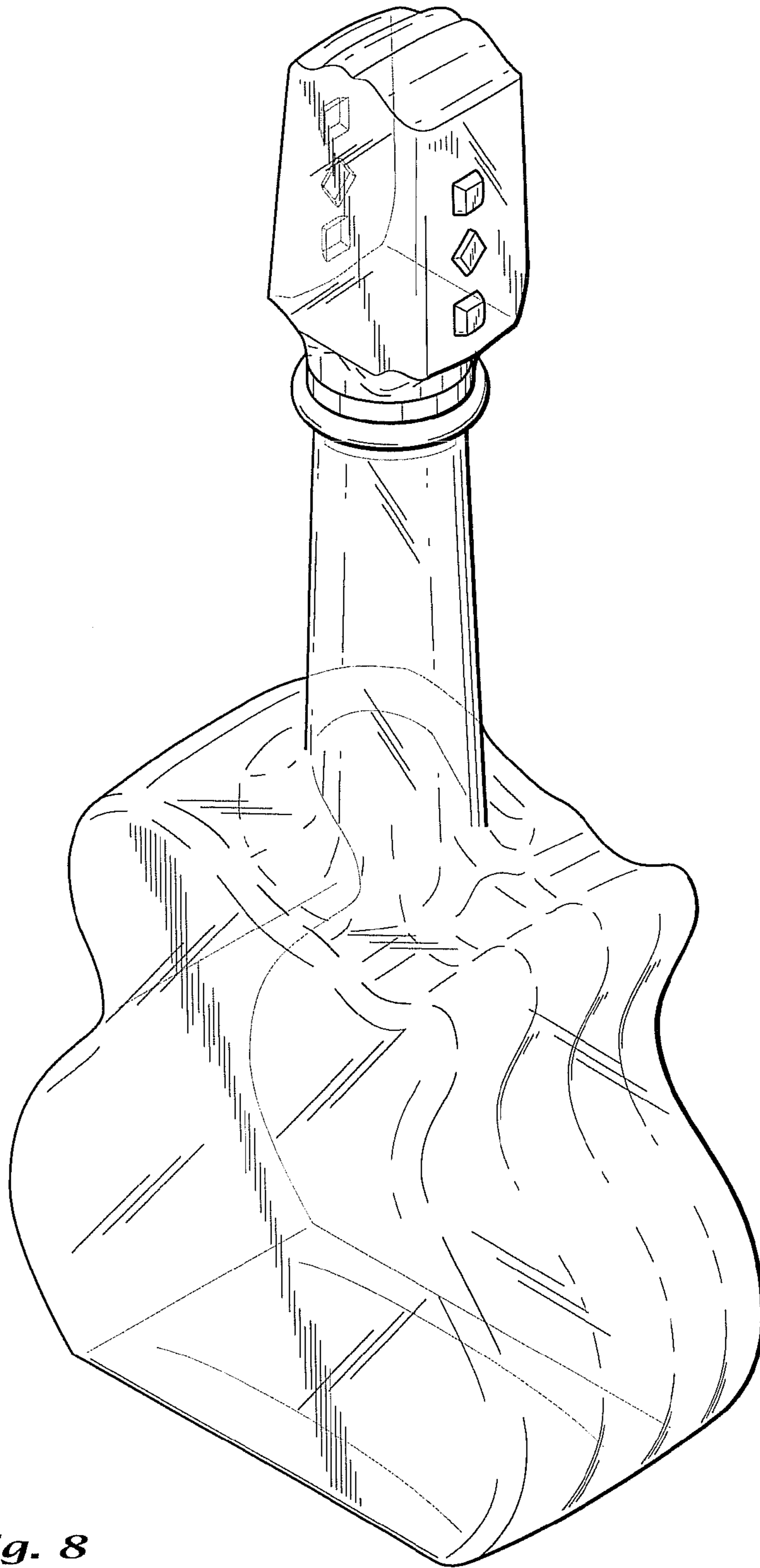

Fig. 8

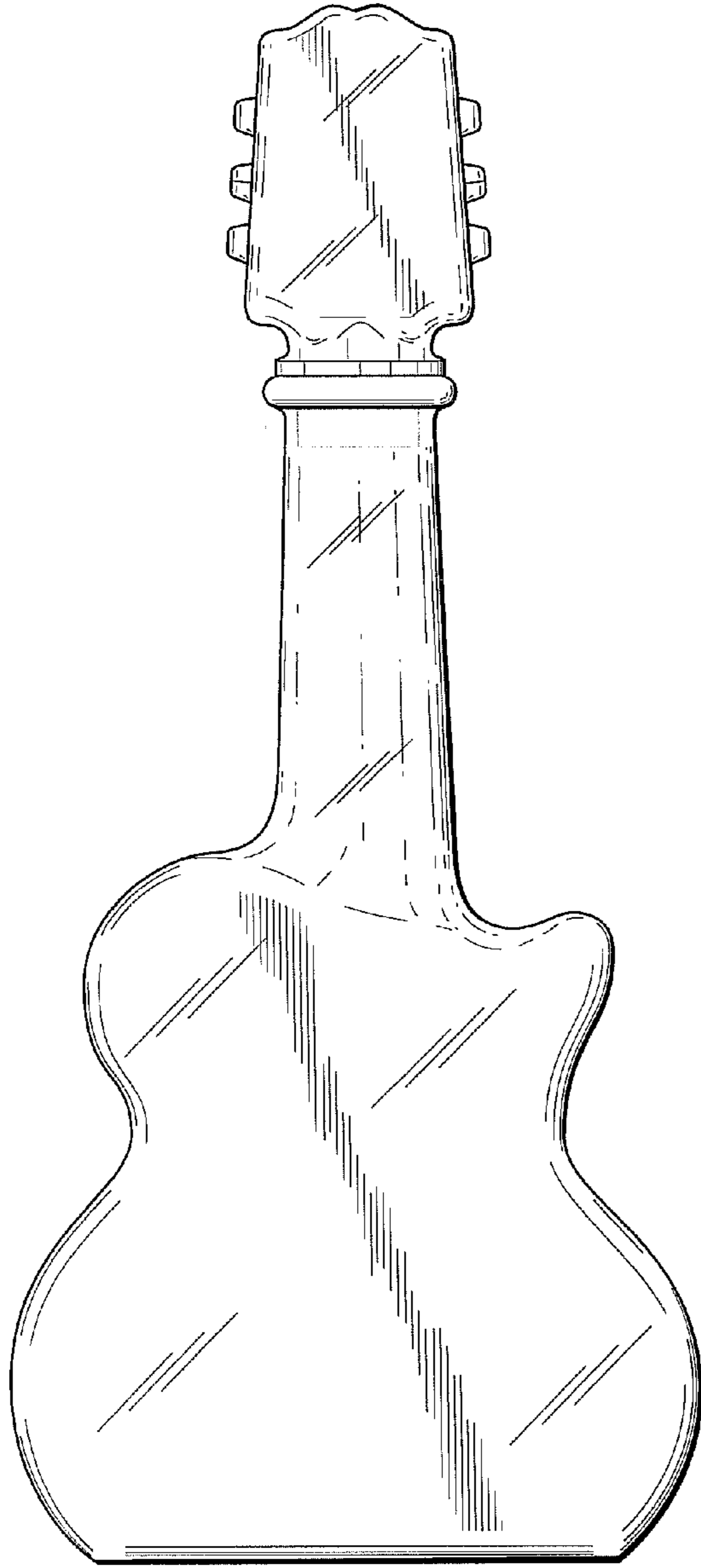

Fig. 9

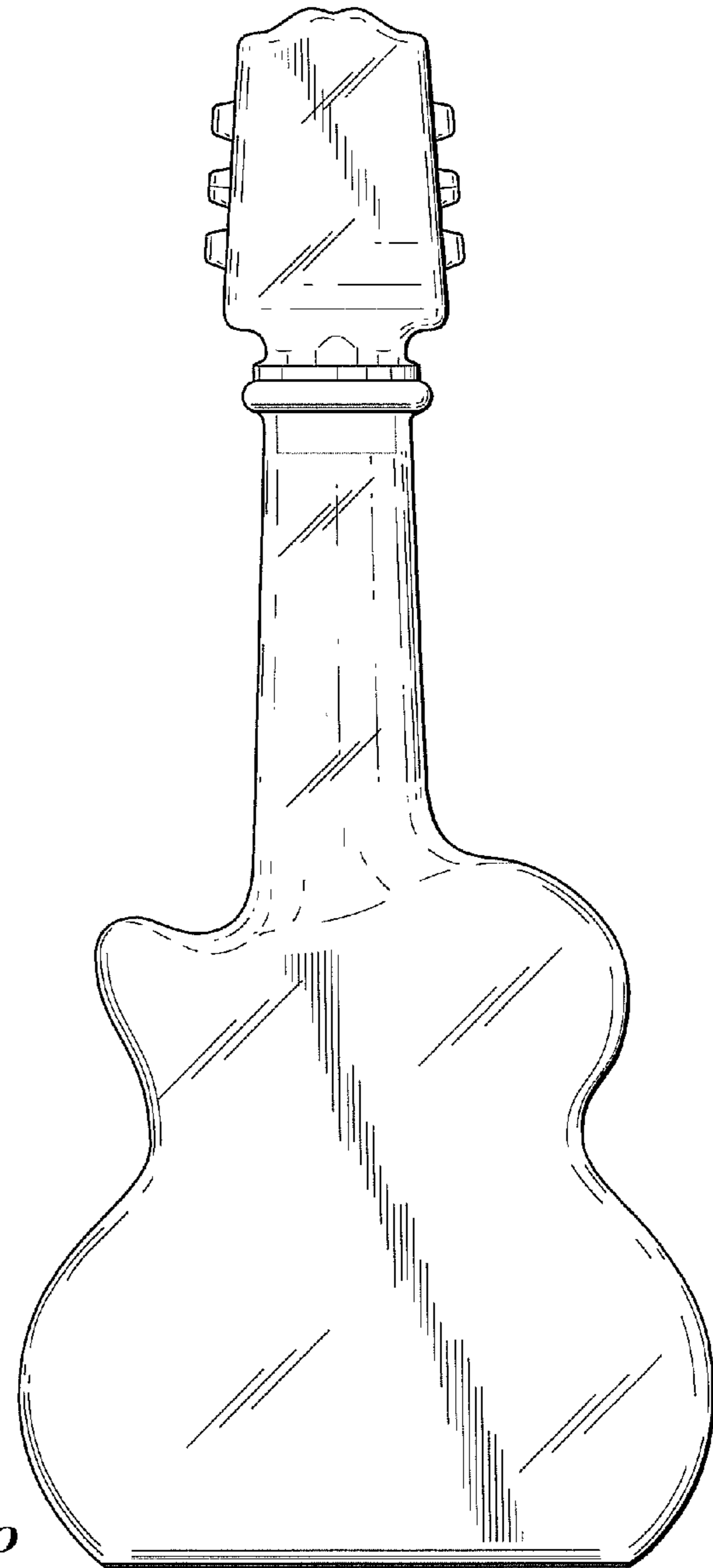

Fig. 10

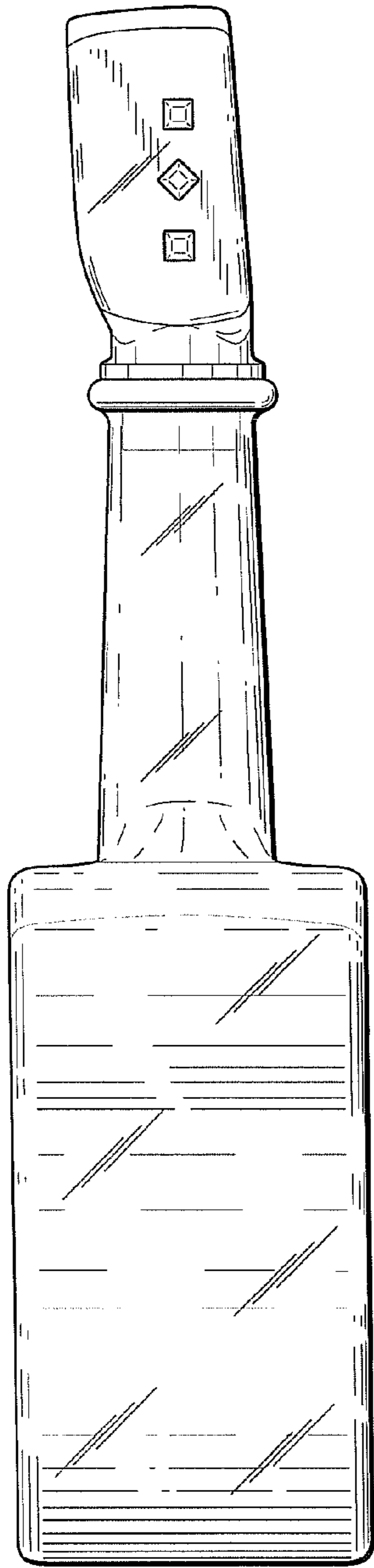

Fig. 11

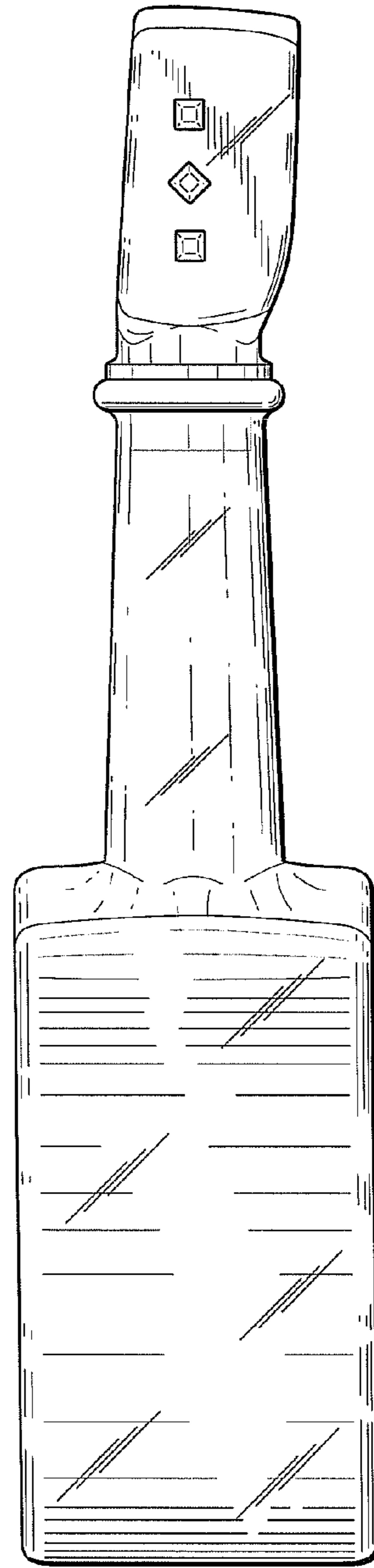

Fig. 12

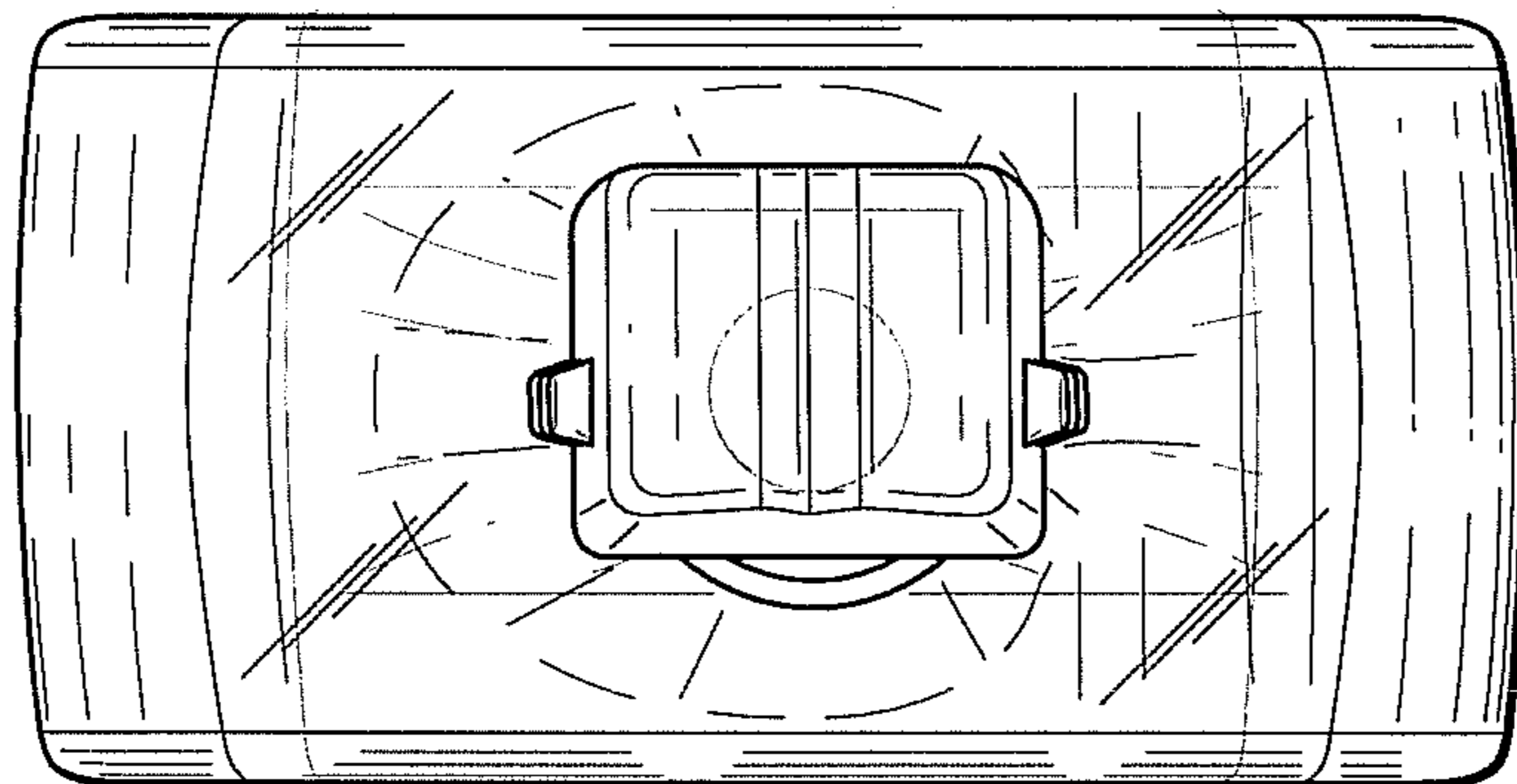

Fig. 13

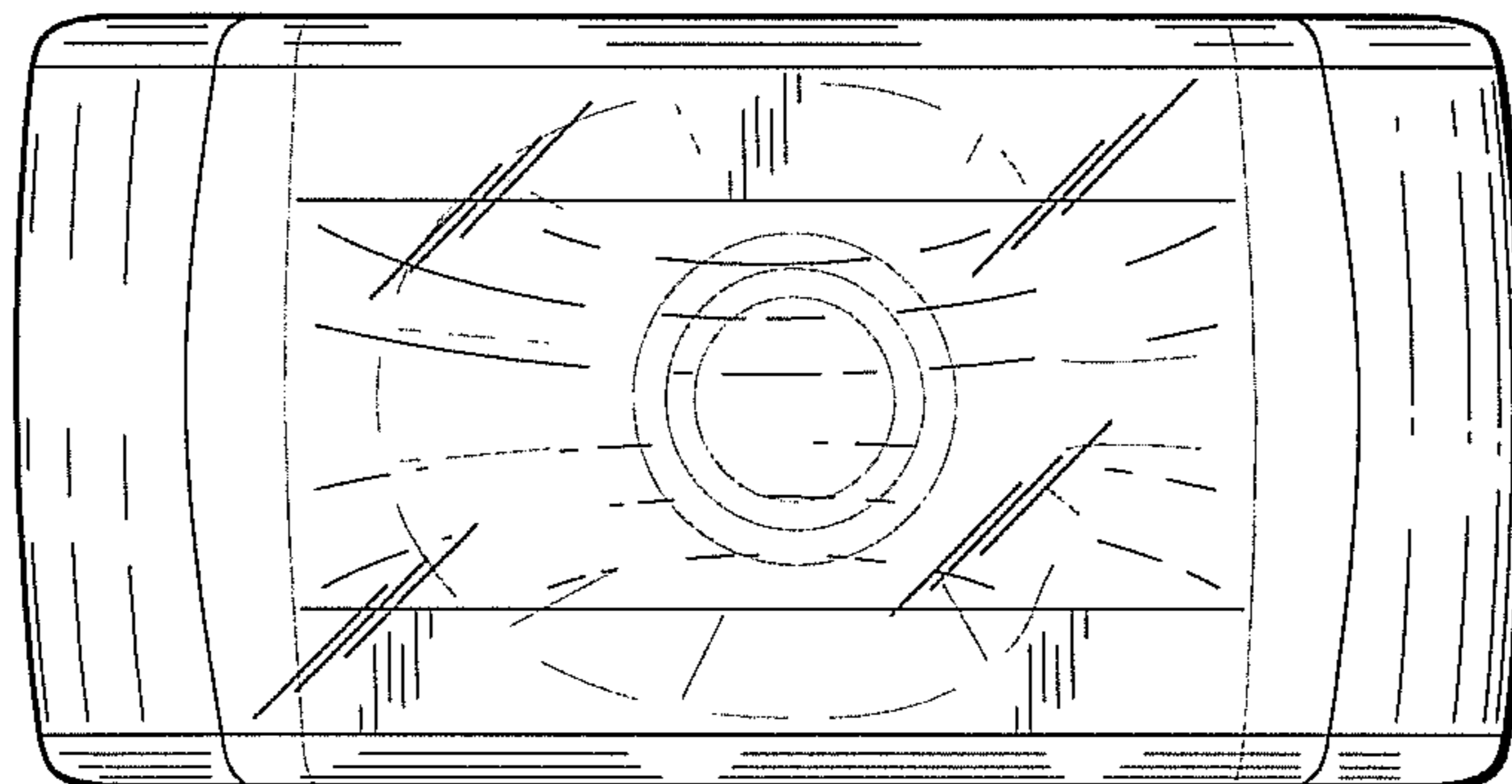

Fig. 14