



US00D680422S

(12) **United States Design Patent**
Murray et al.

(10) **Patent No.:** **US D680,422 S**
(45) **Date of Patent:** **** Apr. 23, 2013**

(54) **PACKAGING FOR A LADDER**

(75) Inventors: **Harry L. Murray**, Mercer, PA (US);
David M. Bartholomew, Greensburg,
PA (US); **Vince A. Genis**, Sharon, PA
(US); **Robert D. Beggs**, Stoneboro, PA
(US)

(73) Assignee: **Werner Co.**, Greenville, PA (US)

(**) Term: **14 Years**

(21) Appl. No.: **29/373,063**

(22) Filed: **Feb. 23, 2011**

(51) **LOC (9) Cl.** **09-03**

(52) **U.S. Cl.**
USPC **D9/414**

(58) **Field of Classification Search** D9/416,
D9/423, 428, 430-433, 449, 455, 444, 501-503,
D9/508, 516, 519, 522, 529, 531, 537, 543,
D9/545, 548-52, 554, 564, 558, 560, 574,
D9/575, 688-692, 737-738, 740, 741, 742,
D9/744, 751, 755, 756, 711, 760, 727, 418,
D9/415, 758, 749, 499, 456; D24/216; 220/23.87,
220/23.89, 475, 592.05, 592.15, 592.23,
220/62.18, 602, 629; D6/300; D8/403

See application file for complete search history.

(56) **References Cited**

U.S. PATENT DOCUMENTS

D394,603 S * 5/1998 Brandes D8/403
D525,760 S * 7/2006 Kissell D34/38
D588,449 S * 3/2009 Bova et al. D9/418

OTHER PUBLICATIONS

<http://www.ebay.com/itm/Werner-81546-01-13-Aluminum-Multi-Position-Ladder-/2308> . . . searched by RMS Nov. 13, 2012.*

* cited by examiner

Primary Examiner — Robert M Spear

Assistant Examiner — Rhea Shields

(74) *Attorney, Agent, or Firm* — Ansel M. Schwartz

(57) **CLAIM**

We claim the ornamental design for the packaging for a ladder, as shown and described.

DESCRIPTION

FIG. 1 is a top plan view of packaging for a ladder showing our new design.

FIG. 2 is a rear elevational view thereof;

FIG. 3 is a left side elevational view thereof;

FIG. 4 is a front elevational view thereof;

FIG. 5 is a right side elevational view thereof;

FIG. 6 is a bottom plan view thereof; and,

FIG. 7 is a front perspective view thereof.

1 Claim, 5 Drawing Sheets

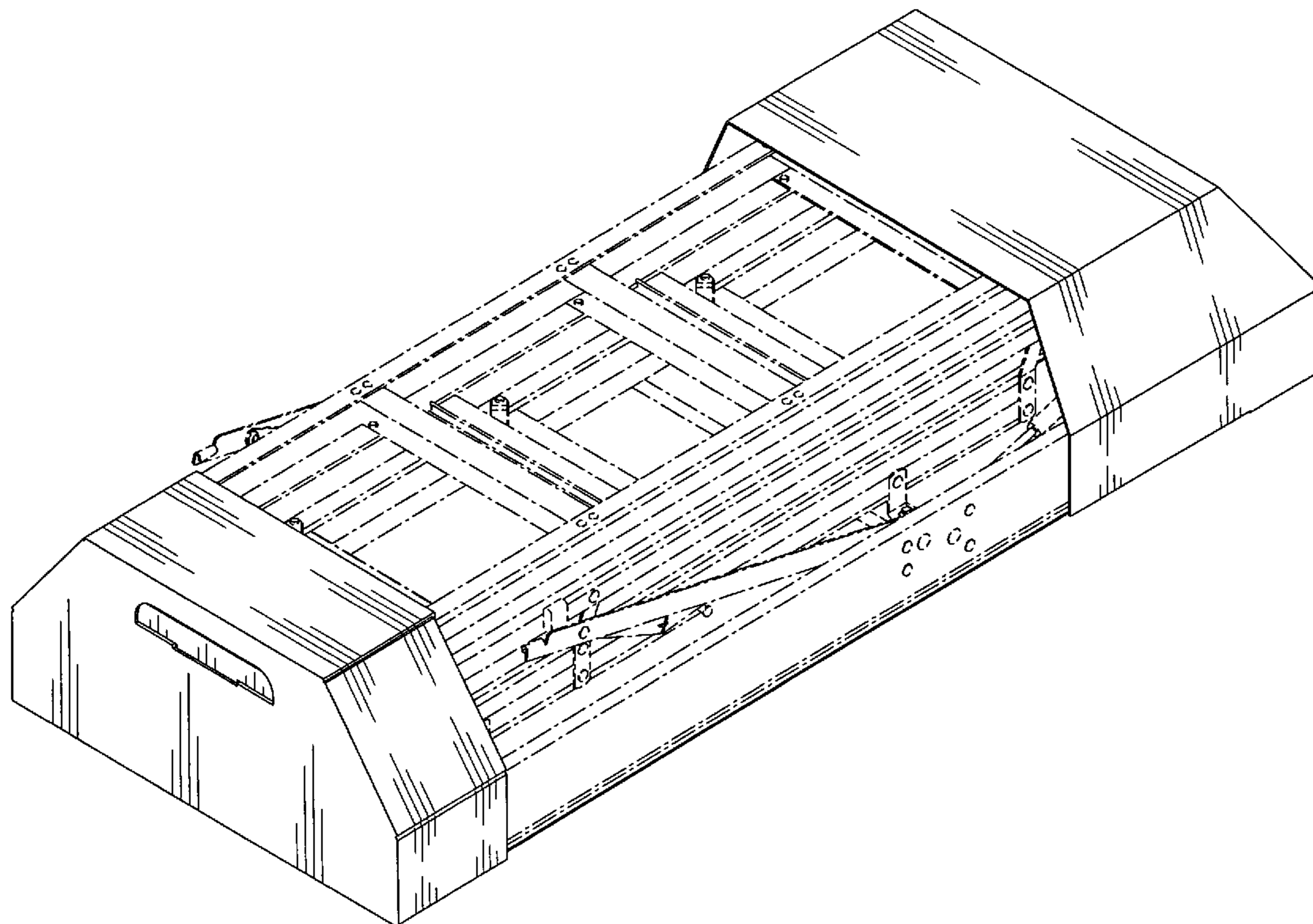

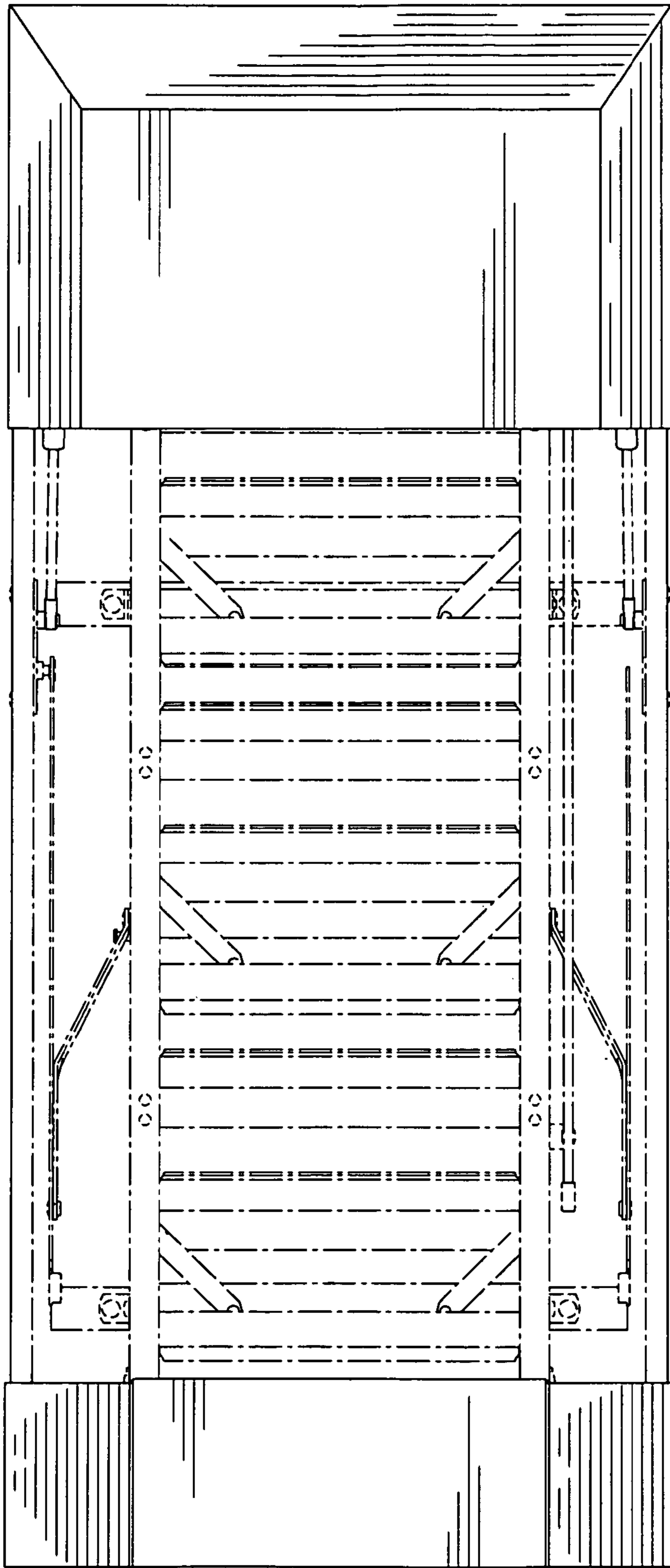

FIG. 1

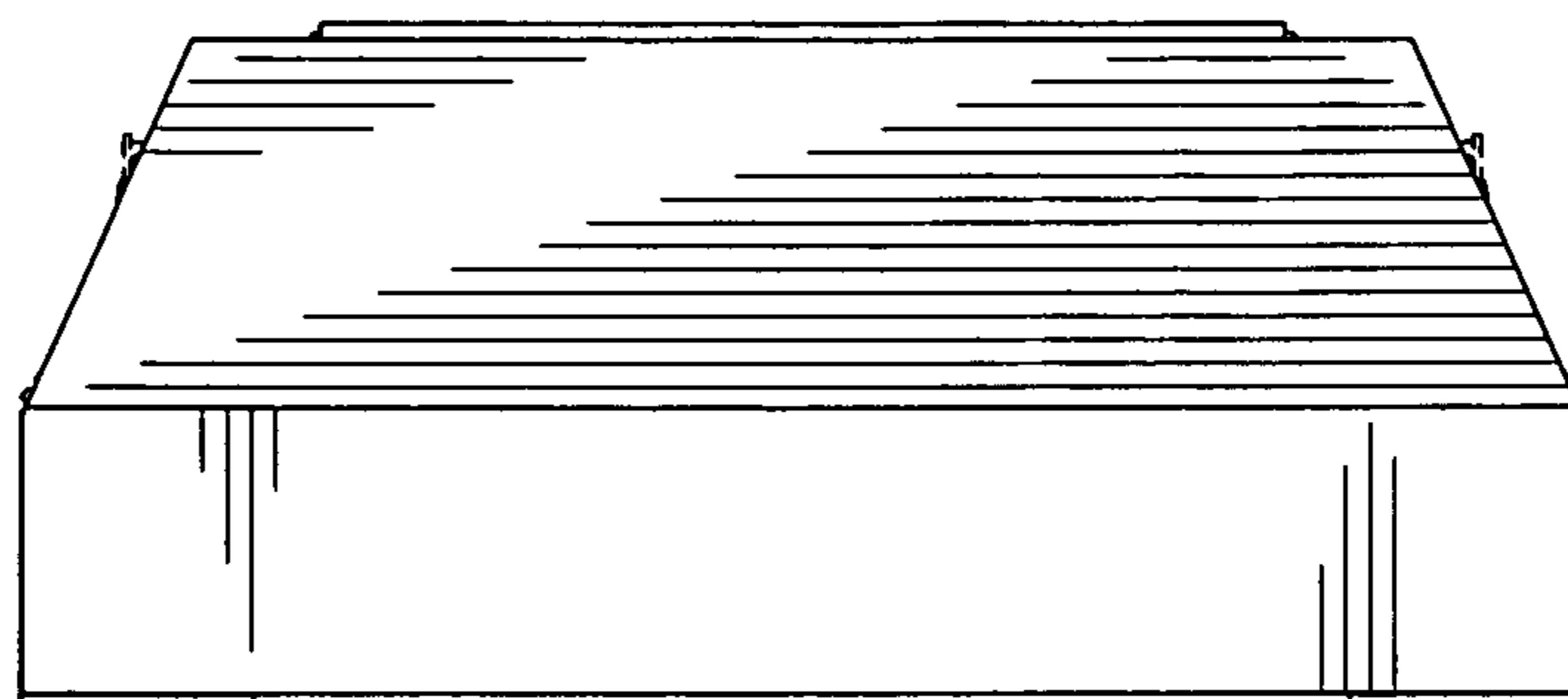

FIG. 2

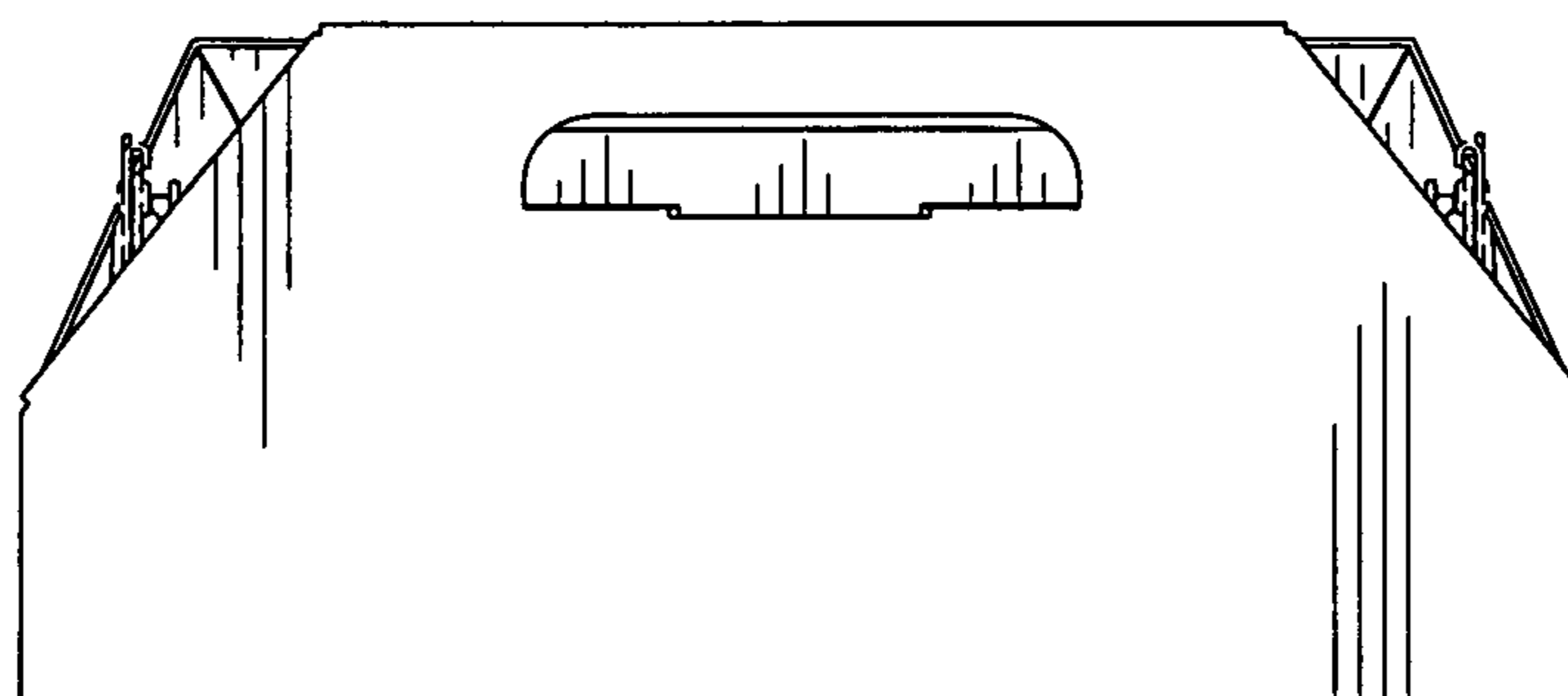

FIG. 4

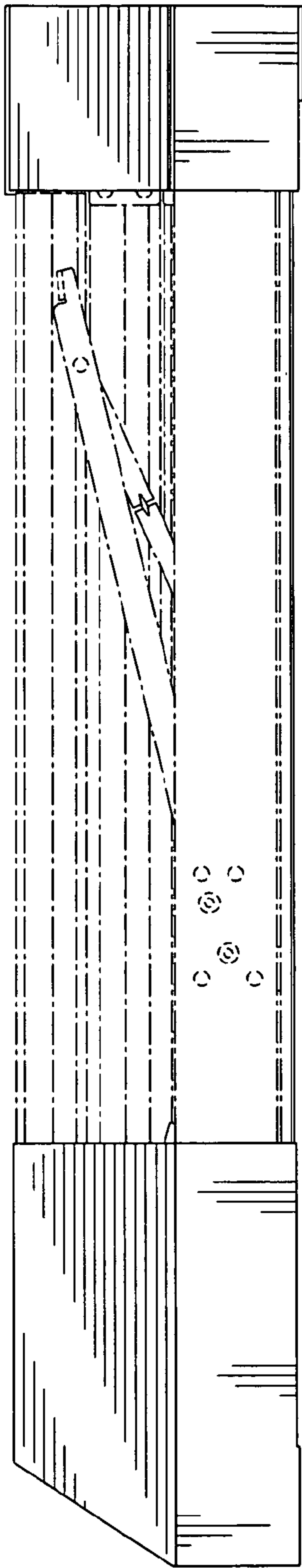

FIG. 3

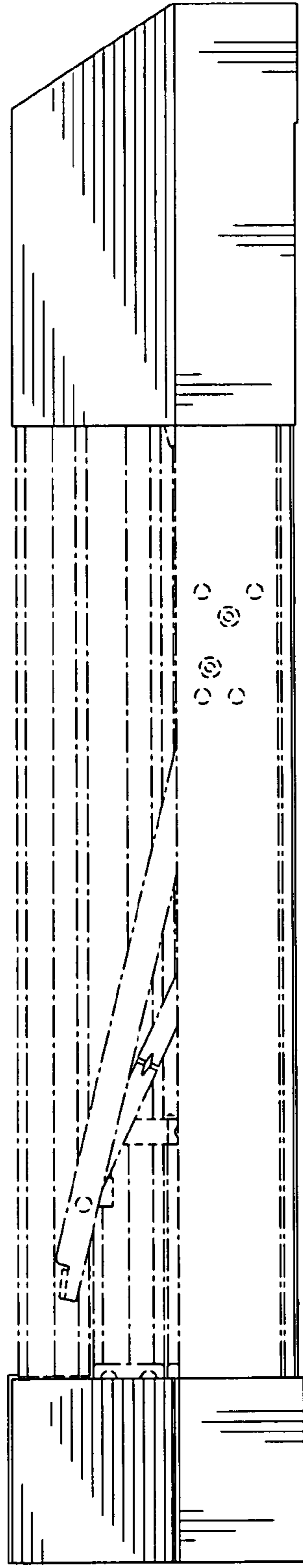

FIG. 5

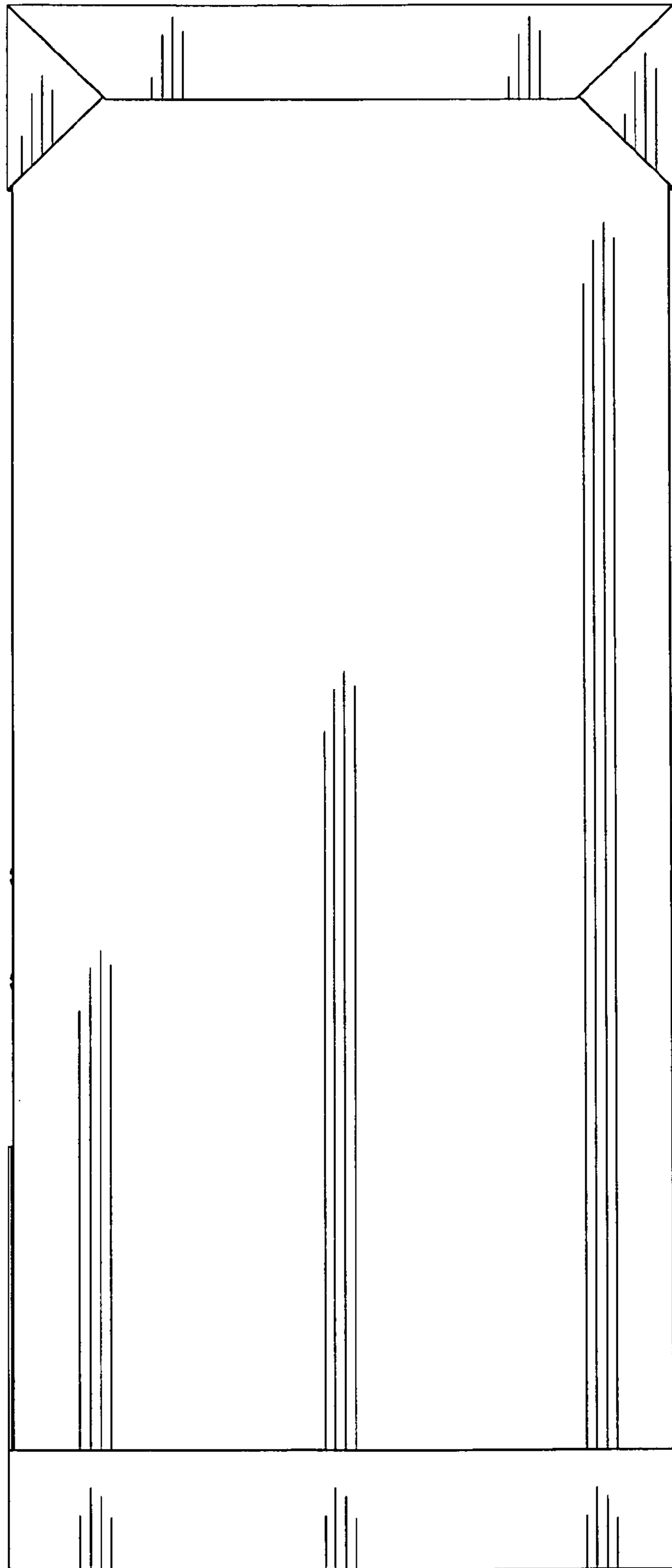

FIG. 6

