



US00D680419S

(12) **United States Design Patent**
Green et al.

(10) **Patent No.:** **US D680,419 S**

(45) **Date of Patent:** **** Apr. 23, 2013**

(54) **SORTING SPACER**

(75) Inventors: **John F. Green**, Baldwinsville, NY (US);
Peter Mendre, Haverhill, MA (US);
Thomas M. Taylor, Lisle, NY (US)

(73) Assignee: **JJG IP Holdings, LLC**, Hampstead, NH (US)

(**) Term: **14 Years**

(21) Appl. No.: **29/422,959**

(22) Filed: **May 25, 2012**

Related U.S. Application Data

(63) Continuation of application No. 12/762,430, filed on Apr. 19, 2010, now abandoned.

(51) **LOC (9) Cl.** **08-05**

(52) **U.S. Cl.**
USPC **D8/354; D8/349**

(58) **Field of Classification Search** D8/349,
D8/354; 209/262, 282, 283, 309, 363, 365.1,
209/671, 667, 660, 664, 666
See application file for complete search history.

(56) **References Cited**

U.S. PATENT DOCUMENTS

1,524,360	A *	1/1925	Lauritzen	209/671
4,795,036	A *	1/1989	Williams	209/667
D308,933	S *	7/1990	Hube et al.	D8/356
5,051,172	A *	9/1991	Gilmore	209/672
D340,564	S *	10/1993	Ledingham	D34/29
D340,941	S *	11/1993	Smith	D17/99
D340,942	S *	11/1993	Smith	D17/99
D354,218	S *	1/1995	Van de Peer	D8/354
D362,382	S *	9/1995	Cloud	D8/354
5,582,300	A *	12/1996	Kobayashi	209/667
5,590,792	A *	1/1997	Kobayashi	209/667
D382,463	S *	8/1997	Cloud	D8/354

D395,815	S *	7/1998	Walters et al.	D8/354
5,960,964	A *	10/1999	Austin et al.	209/672
6,076,684	A *	6/2000	Bollegraaf	209/668
6,092,968	A *	7/2000	Lanham et al.	411/431
6,149,018	A *	11/2000	Austin et al.	209/672
6,250,477	B1 *	6/2001	Swanink	209/386
6,250,478	B1 *	6/2001	Davis	209/672
6,318,560	B2 *	11/2001	Davis	209/672
6,371,305	B1	4/2002	Austin et al.	
6,460,706	B1 *	10/2002	Davis	209/672
6,648,145	B2	11/2003	David et al.	
D487,039	S *	2/2004	Webster et al.	D12/180
D490,293	S *	5/2004	Brown	D8/354
D503,801	S *	4/2005	Jackson	D24/155
7,004,332	B2	2/2006	Davis	
D525,181	S *	7/2006	Horner	D12/180
7,261,209	B2 *	8/2007	Duncan et al.	209/672
D559,080	S *	1/2008	Boote	D8/354
D576,932	S *	9/2008	Strehler	D12/180
7,578,396	B1 *	8/2009	Garzon	209/667
7,661,537	B1	2/2010	Sewell	
D613,412	S *	4/2010	DeCarlo	D24/186

(Continued)

Primary Examiner — Mark Goodwin

(74) *Attorney, Agent, or Firm* — Maine Cernota & Rardin

(57) **CLAIM**

The ornamental design for a sorting spacer, as shown and described.

DESCRIPTION

FIG. 1 is a perspective view of a sorting spacer, showing our new design;
FIG. 2 is a top view thereof;
FIG. 3 is a right side view thereof;
FIG. 4 is a bottom view thereof;
FIG. 5 is a front view thereof;
FIG. 6 is a left side view thereof; and,
FIG. 7 is a back view thereof.

1 Claim, 7 Drawing Sheets

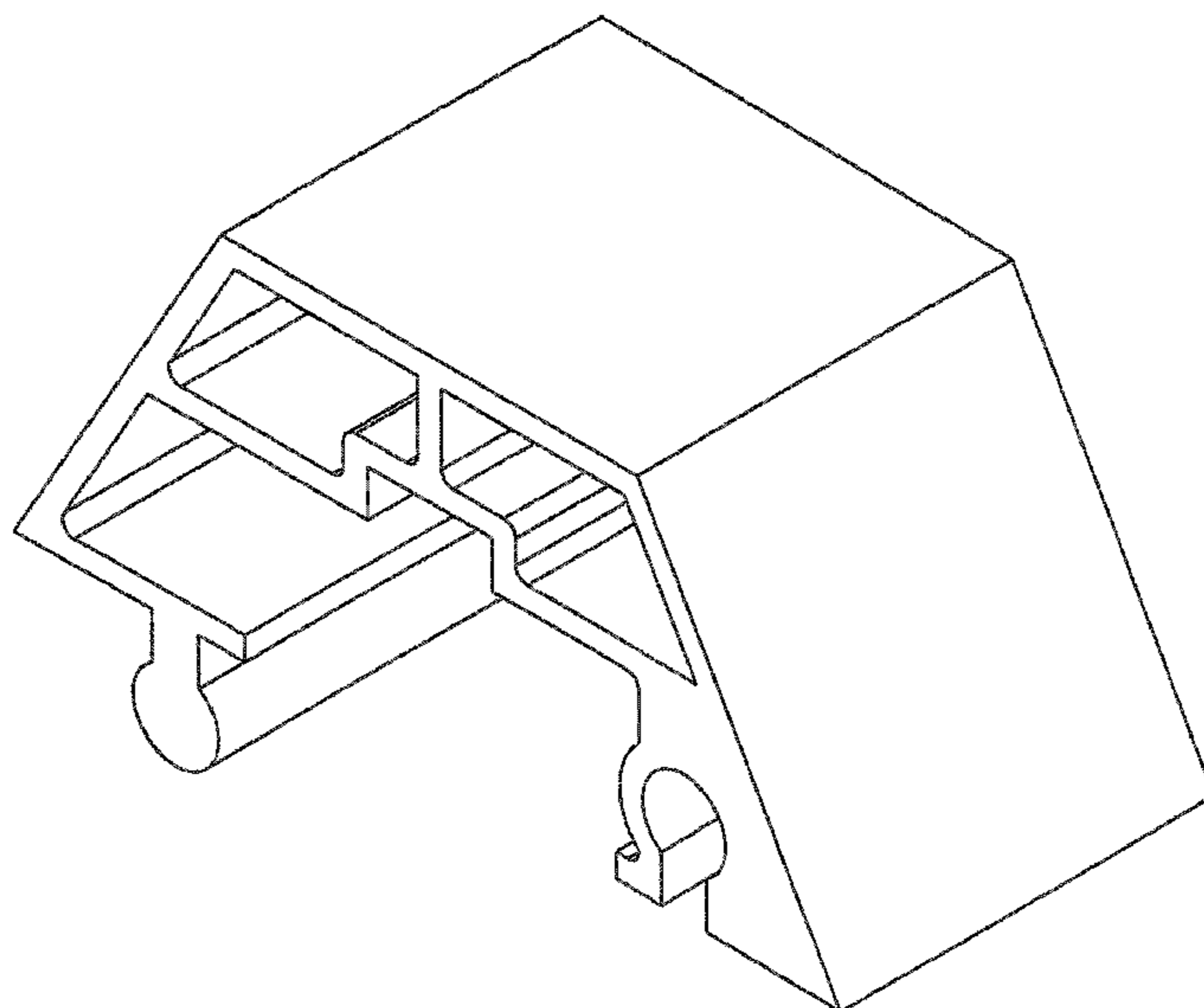

US D680,419 S

Page 2

U.S. PATENT DOCUMENTS			
D618,985 S *	7/2010	Sjoqvist	D8/356
D619,940 S *	7/2010	Strang	D12/159
2001/0004059 A1*	6/2001	Davis	209/672
2004/0079684 A1*	4/2004	Davis et al.	209/667
2006/0180524 A1*	8/2006	Duncan et al.	209/672
2010/0264069 A1*	10/2010	Green et al.	209/262
2011/0108467 A1*	5/2011	Campbell et al.	209/522

* cited by examiner

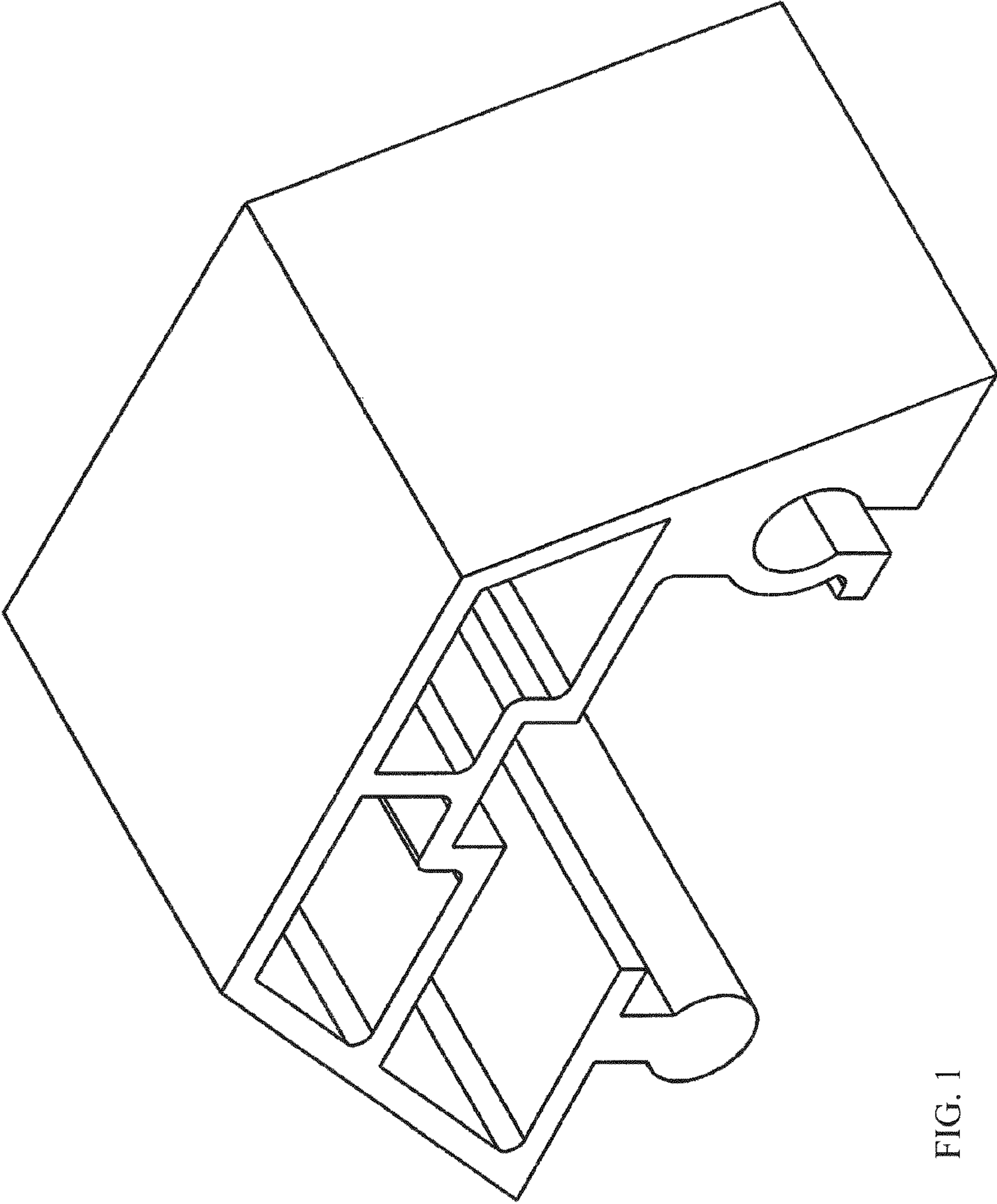

FIG. 1

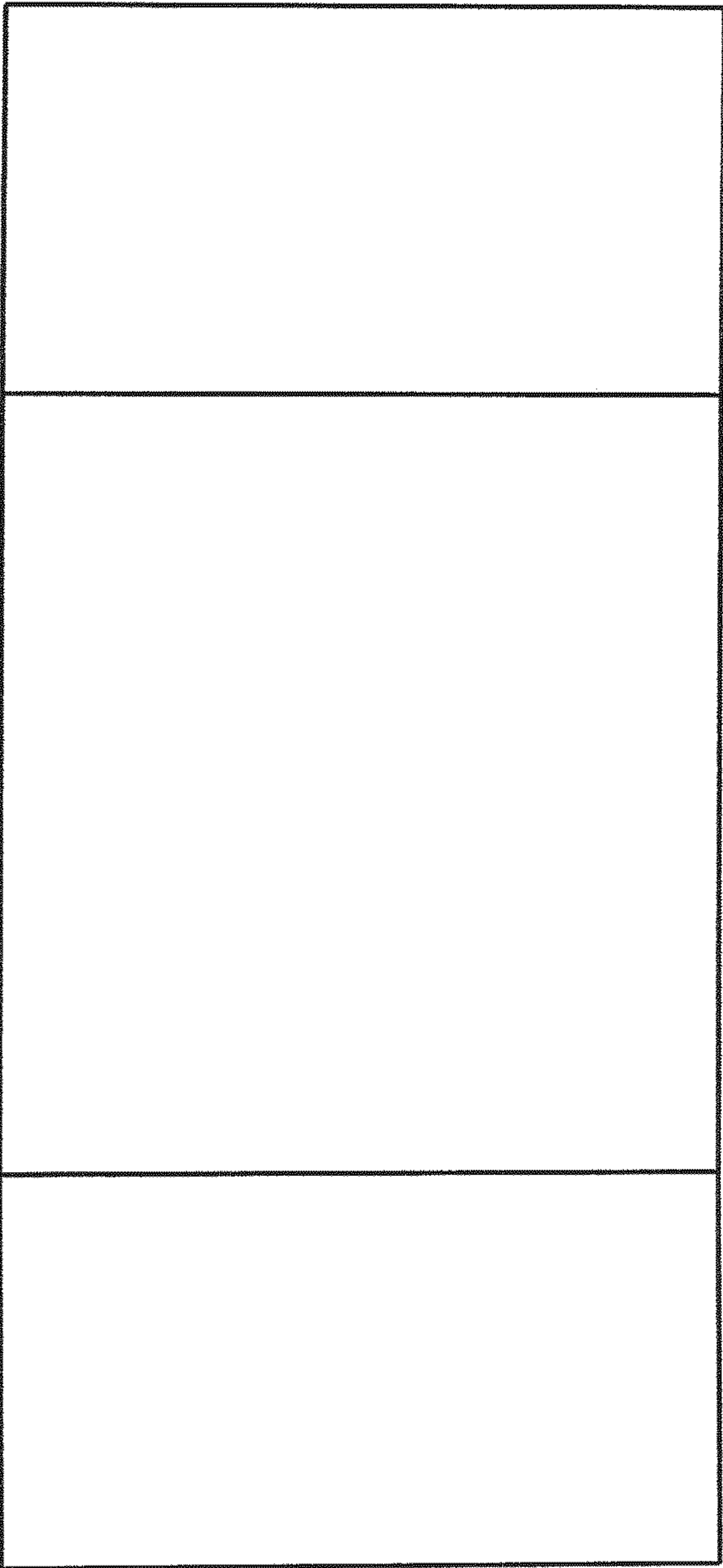

FIG. 2

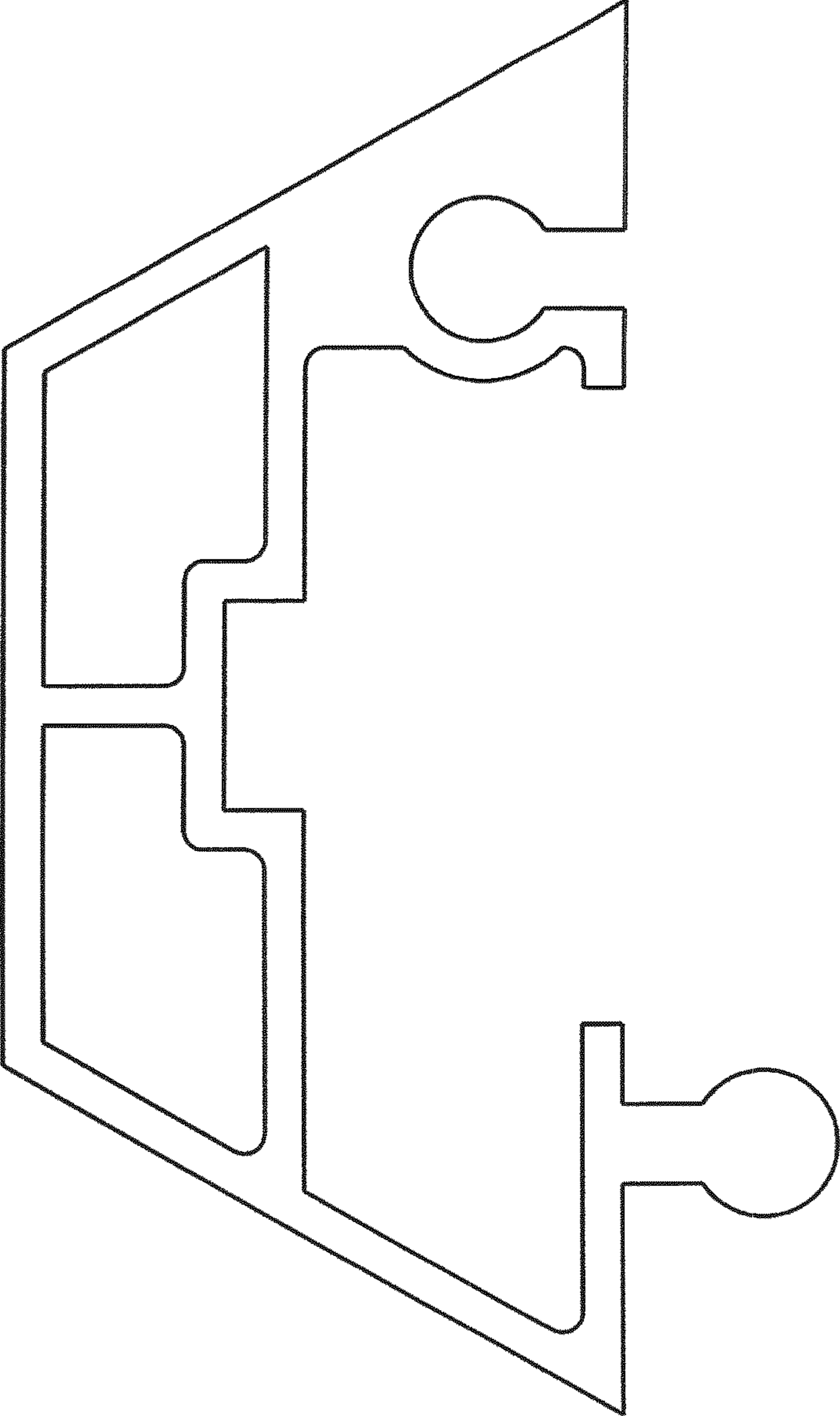

FIG. 3



FIG. 4

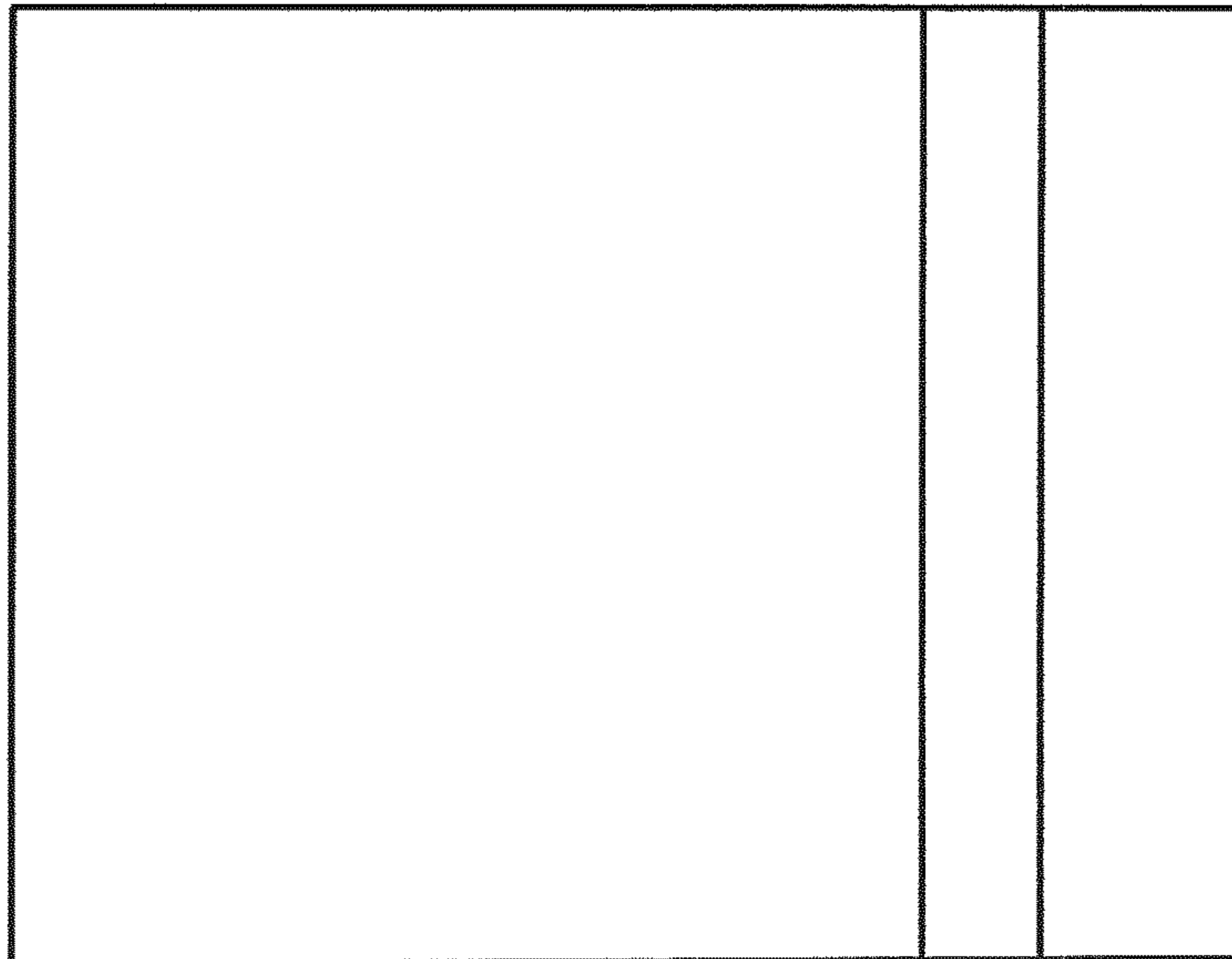

FIG. 5

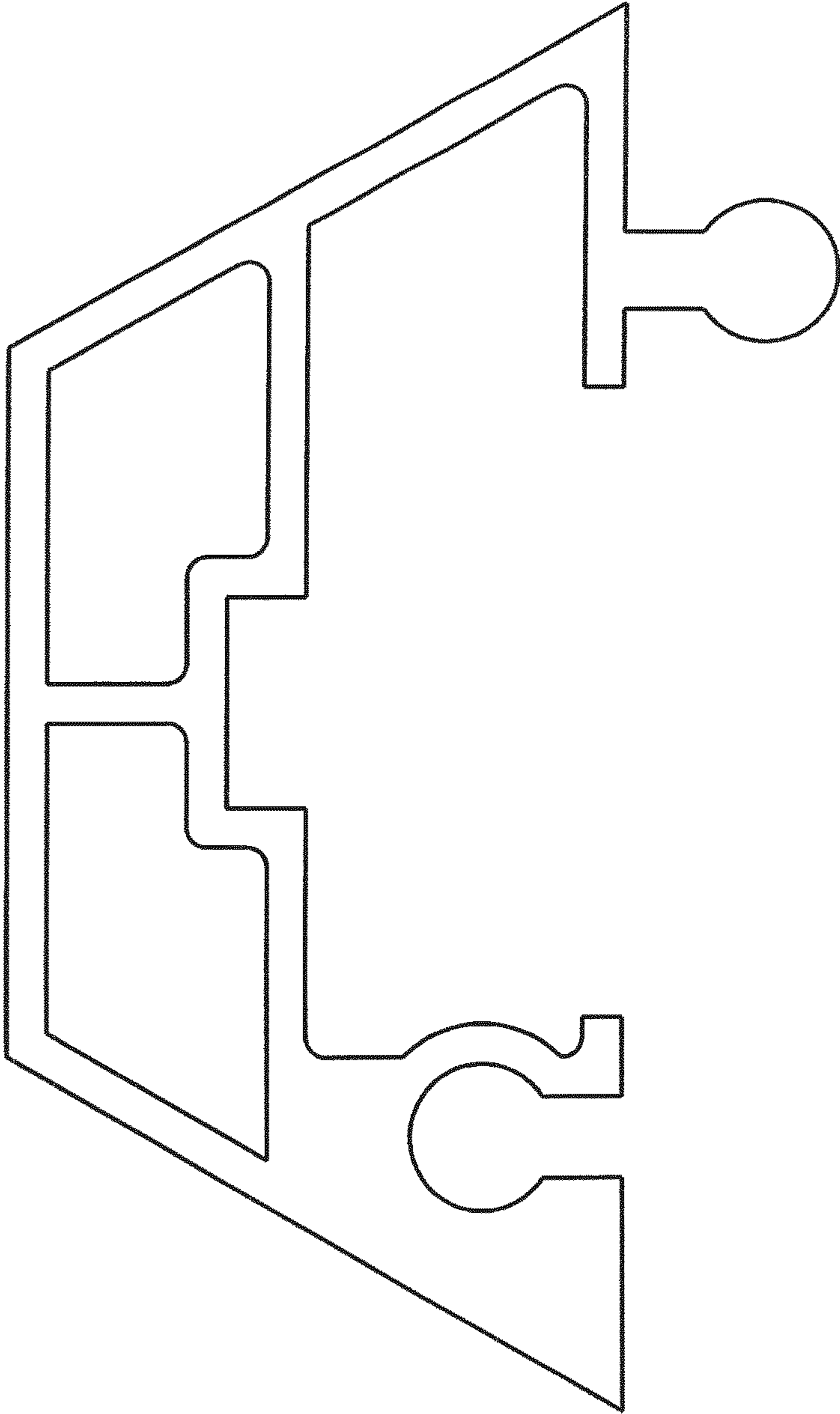

FIG. 6

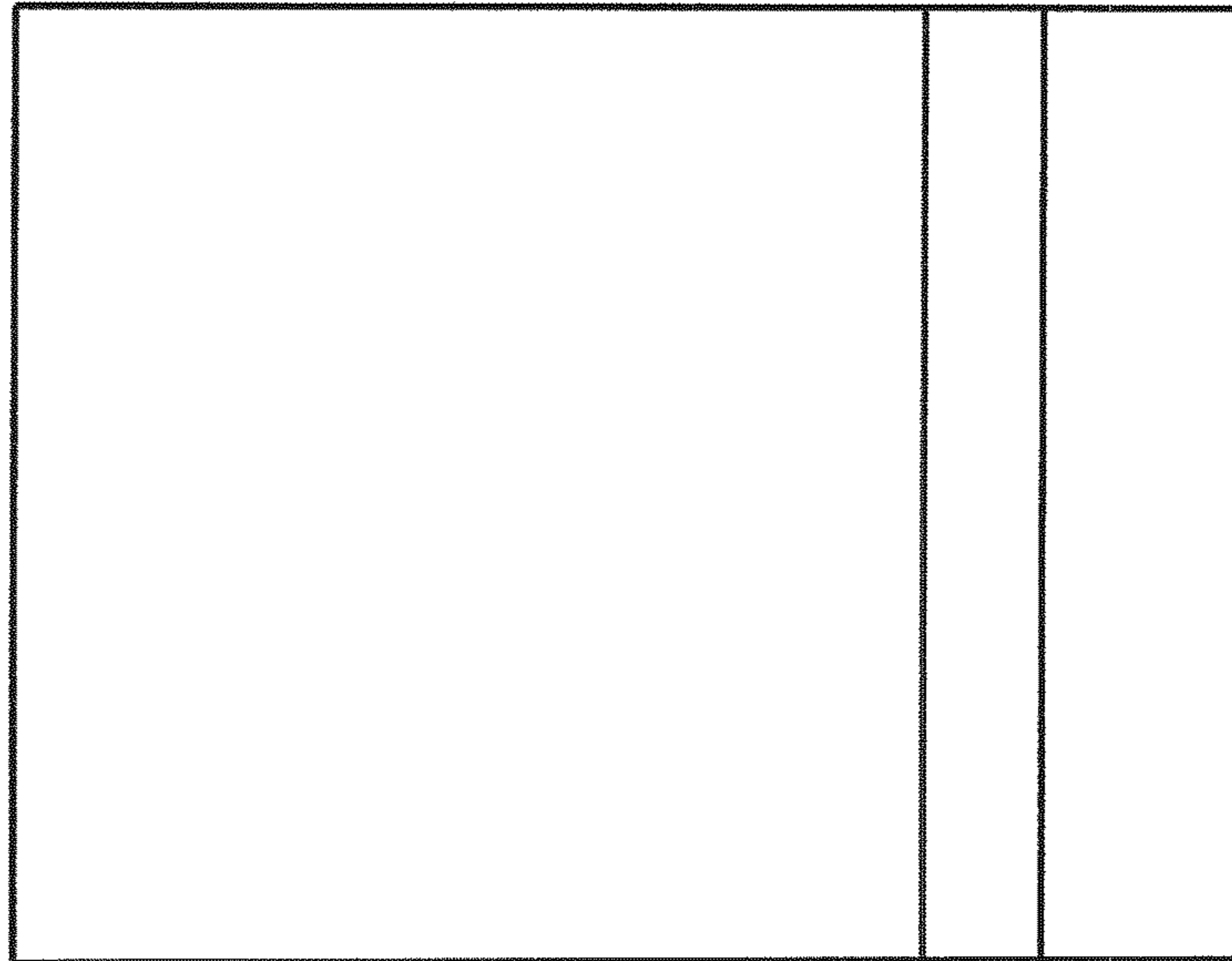

FIG. 7