

US00D680296S

(12) **United States Design Patent**
Villota et al.

(10) **Patent No.:** **US D680,296 S**
(45) **Date of Patent:** **** Apr. 23, 2013**

(54) **FOOD PRODUCT**

(75) Inventors: **Ricardo Villota**, Lake Zurich, IL (US);
Guillermo Haro, Skokie, IL (US)

(73) Assignee: **Kraft Foods Group Brands LLC**,
Northfield, IL (US)

(**) Term: **14 Years**

(21) Appl. No.: **29/425,459**

(22) Filed: **Jun. 22, 2012**

Related U.S. Application Data

(62) Division of application No. 29/394,290, filed on Jun. 15, 2011, now Pat. No. Des. 662,276.

(51) **LOC (9) Cl.** **01-01**

(52) **U.S. Cl.**
USPC **D1/106**

(58) **Field of Classification Search** D1/100–130,
D1/199; D7/335, 556, 359, 672, 675, 676,
D7/677, 900; 473/420, 477; D21/699, 303,
D21/314, 318, 324, 339, 341, 357, 369, 378,
D21/385, 386, 788; D11/14, 30, 44, 48,
D11/81, 33, 68; D6/597, 601; D9/668

See application file for complete search history.

(56) **References Cited**

U.S. PATENT DOCUMENTS

D213,944 S *	4/1969	Cooper	D1/110
D260,468 S *	9/1981	Huebner	D6/597
D301,990 S *	7/1989	Webb	D11/81
D359,645 S *	6/1995	Luccisano	D6/601
D452,649 S *	1/2002	Davis	D9/632
D513,551 S *	1/2006	Haro	D1/126
D531,847 S *	11/2006	Lesniak	D6/597
D533,051 S *	12/2006	Kelleghan	D8/356

D535,157 S *	1/2007	Hoehne	D7/628
D557,987 S *	12/2007	Hoehne	D7/551.1
D585,327 S *	1/2009	Jenkins	D11/157
D621,126 S *	8/2010	Haro et al.	D1/106
D631,277 S *	1/2011	Curtis	D6/588

OTHER PUBLICATIONS

Brochure of pasta shapes. <https://www.funpastafundraising.com/shop/products.php?id=2955&&th=2&&p=30>, 16 pages. (Tailgate and Celebrate Pasta believed to be on sale at least by about Mar. 2011.).

Photo of Tailgate and Celebrate Pasta. <http://www.teamtailgateshop.com/pstail750.html>, 3 pages. (Tailgate and Celebrate Pasta believed to be on sale at least by about Mar. 2011.).

Photo of Tailgate and Celebrate Pasta. <https://pastashoppe.com/product.php?id=52&&c=2>, 2 pages. (Tailgate and Celebrate Pasta believed to be on sale at least by about Mar. 2011.).

* cited by examiner

Primary Examiner — Cathron Brooks

Assistant Examiner — Katie Mroczka

(74) *Attorney, Agent, or Firm* — Fitch, Even, Tabin & Flannery LLP

(57) **CLAIM**

We claim the ornamental design for a food product, as shown and described.

DESCRIPTION

FIG. 1 is a perspective view of a food product showing our new design, comprising a helmet-shaped food product;

FIG. 2 is a back elevation thereof;

FIG. 3 is a front elevation thereof;

FIG. 4 is a left side elevation thereof;

FIG. 5 is a right side elevation thereof;

FIG. 6 is a top plan thereof; and,

FIG. 7 is a bottom plan thereof.

1 Claim, 2 Drawing Sheets

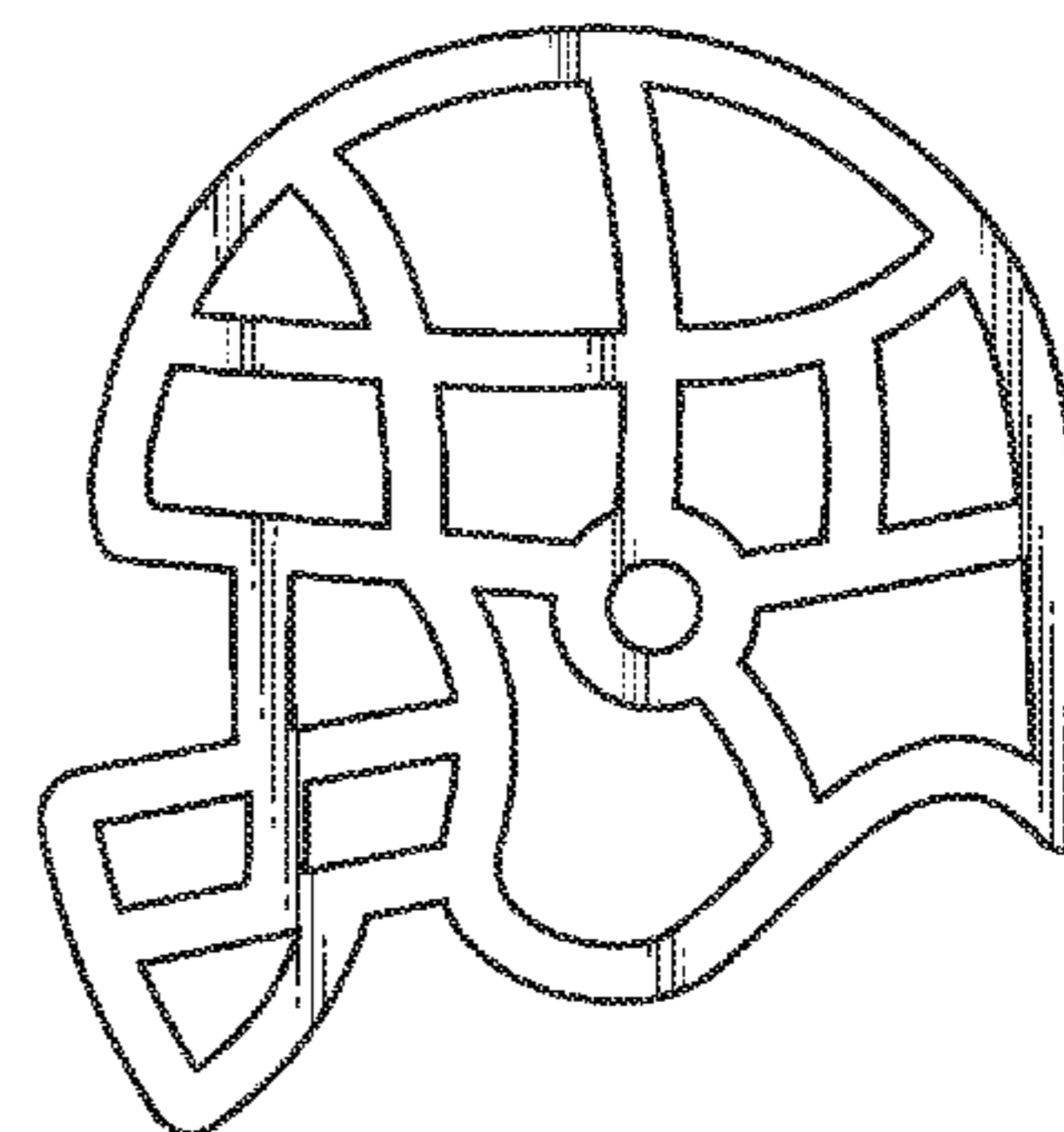
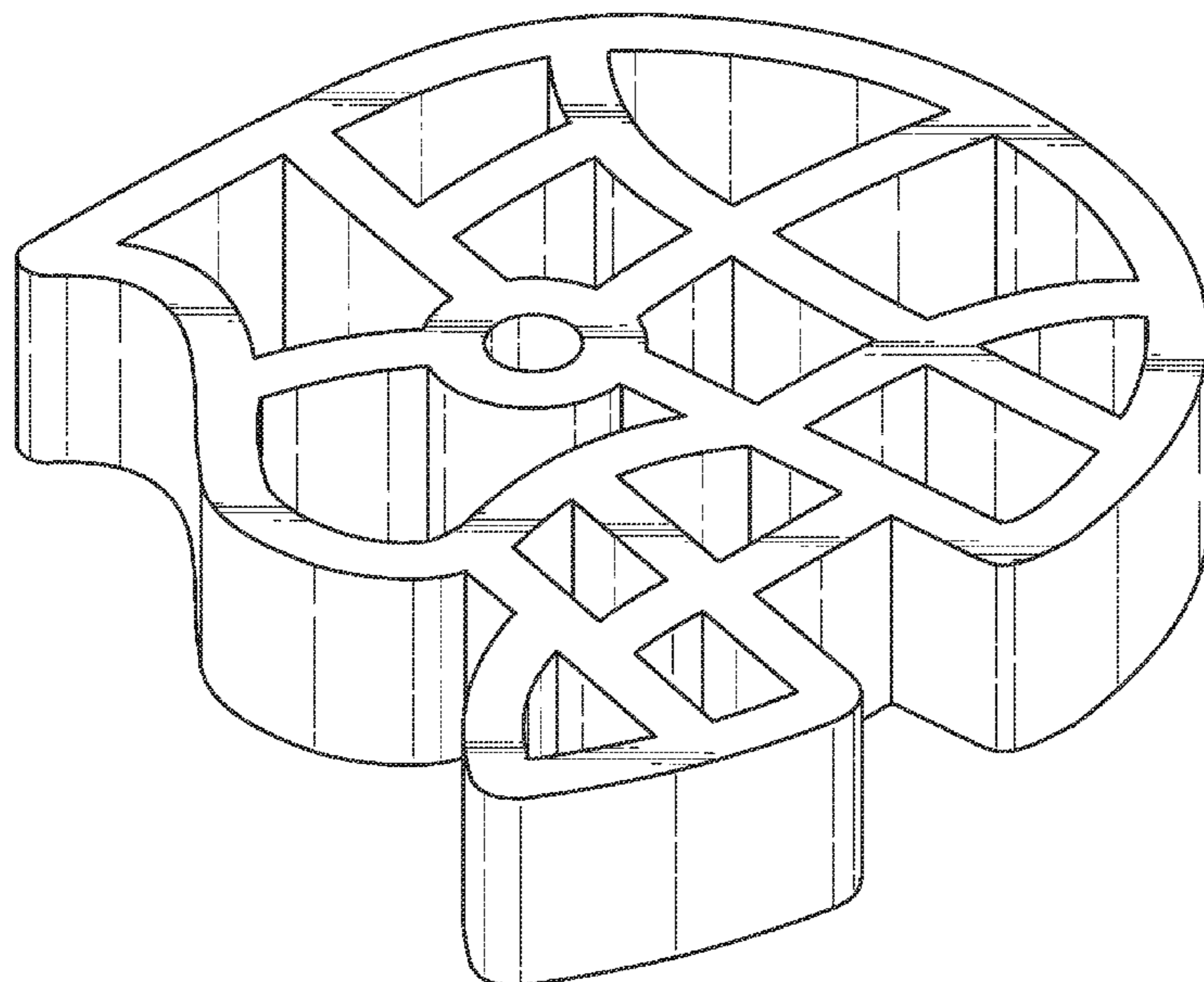

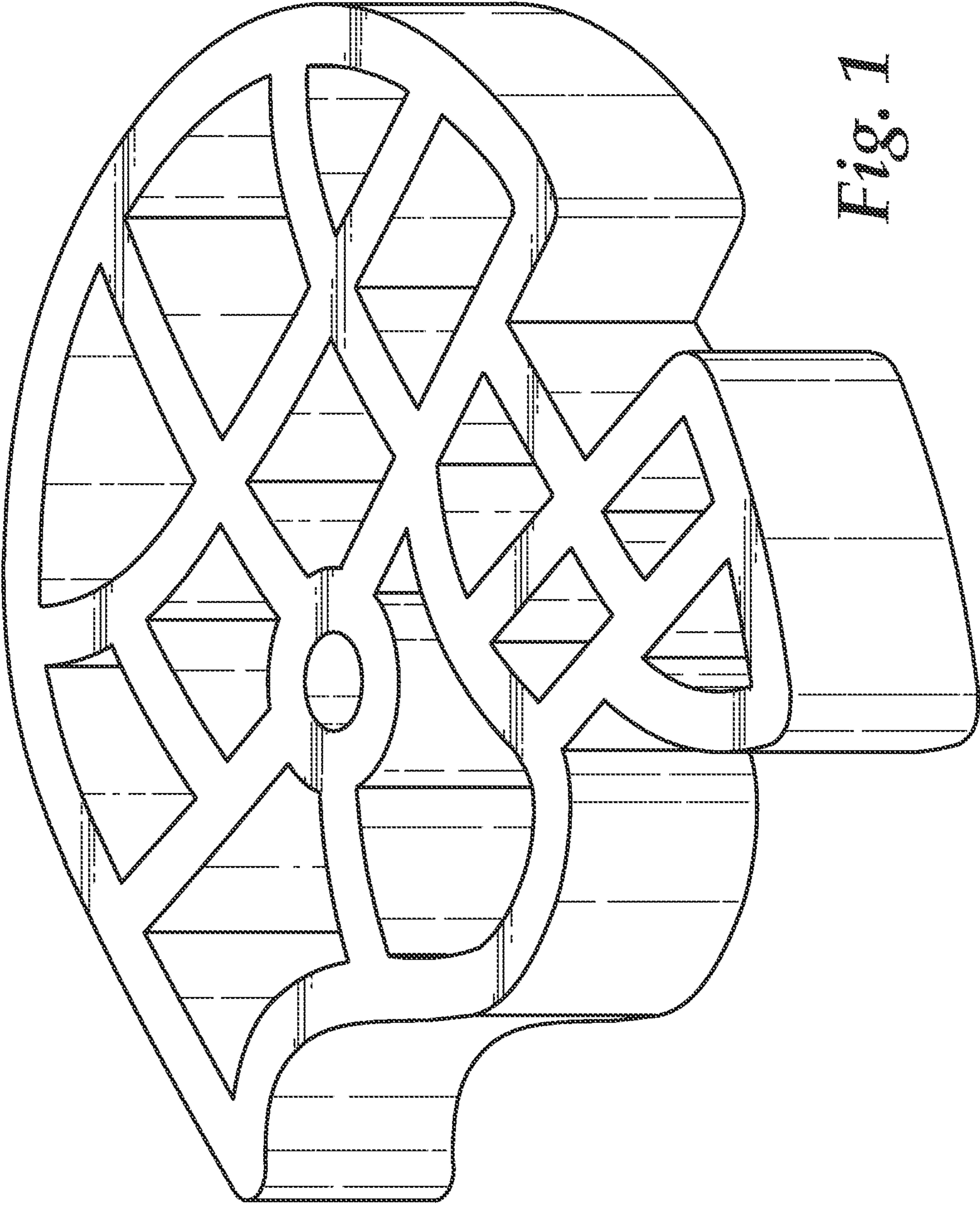

Fig. 1

Fig. 2

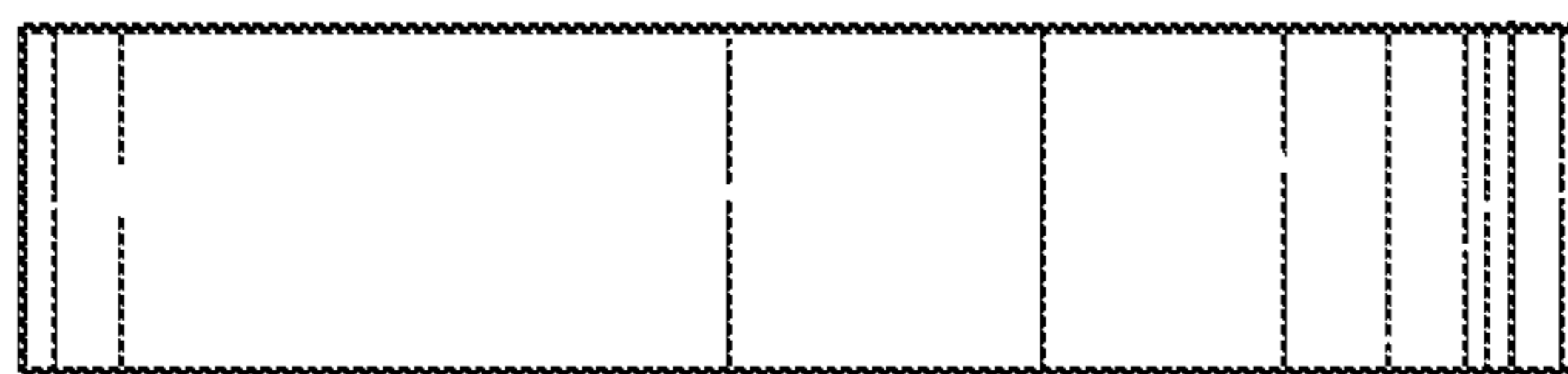
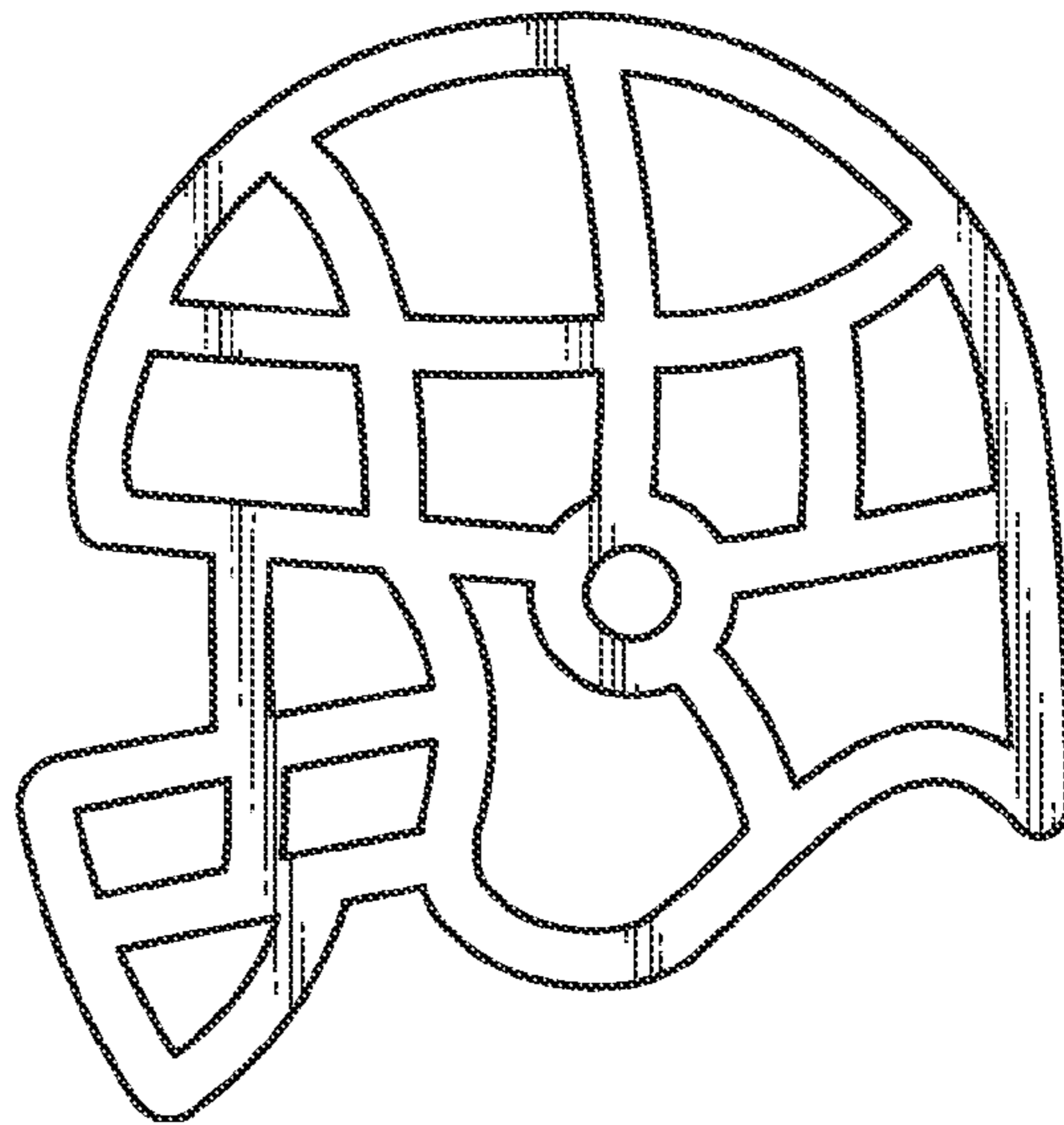

Fig. 6

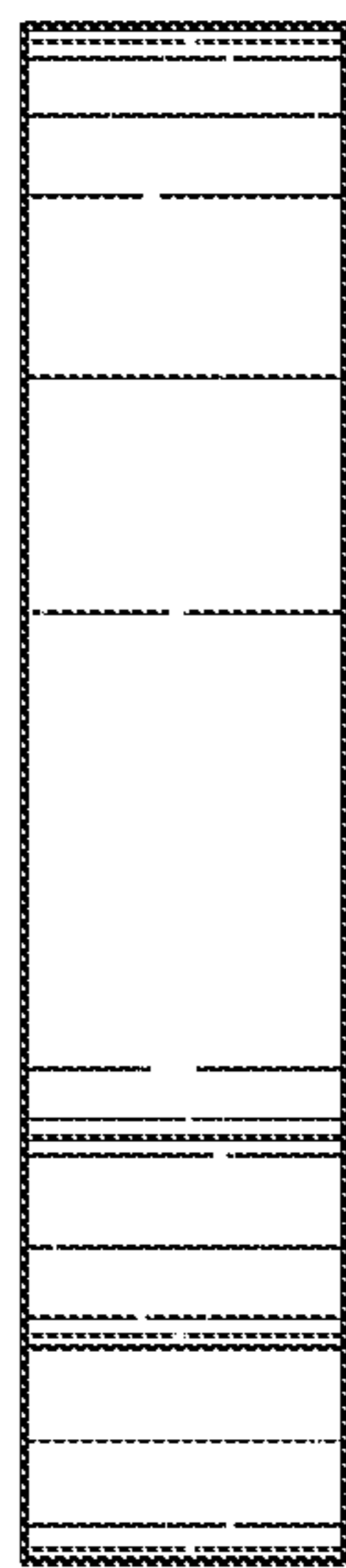

Fig. 4

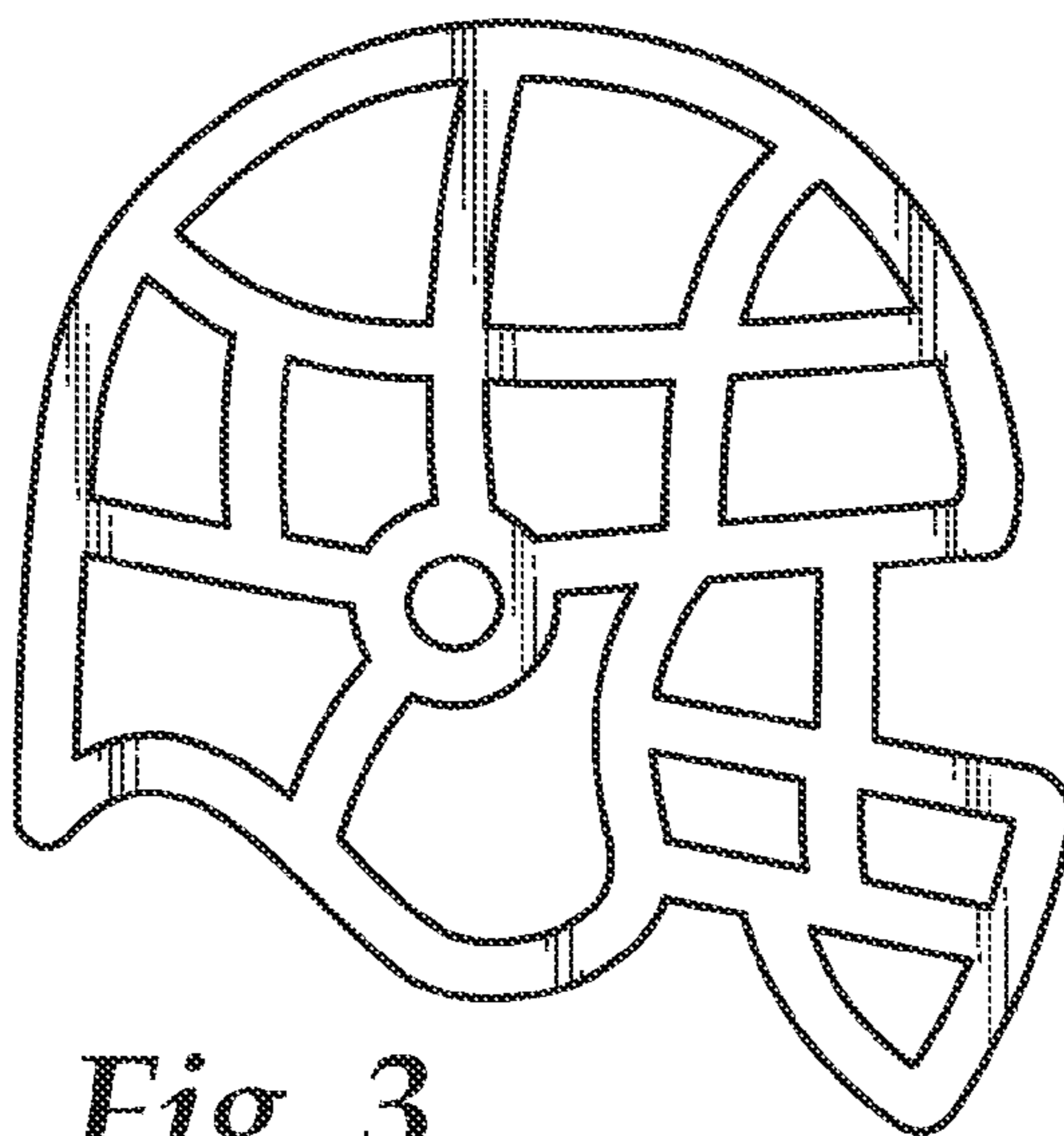

Fig. 3

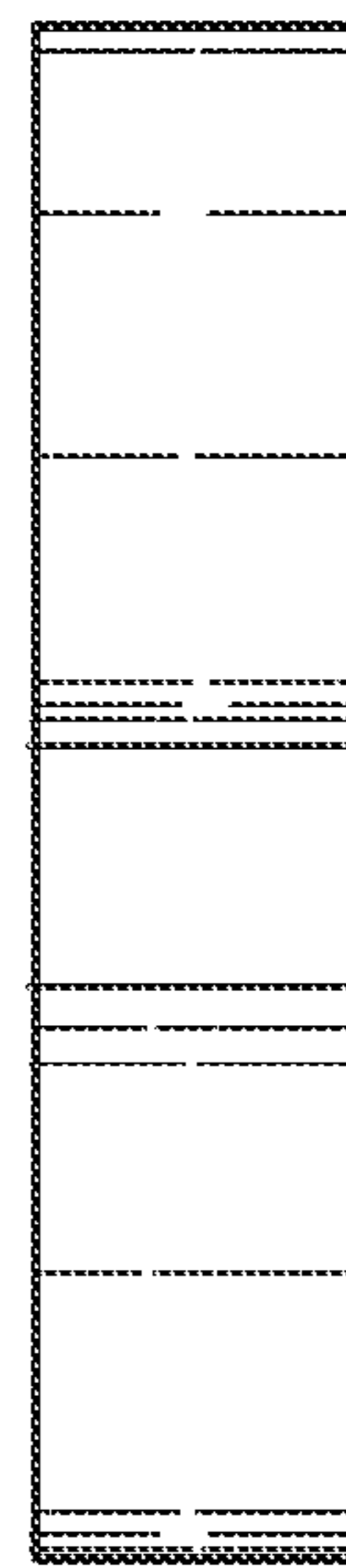

Fig. 5

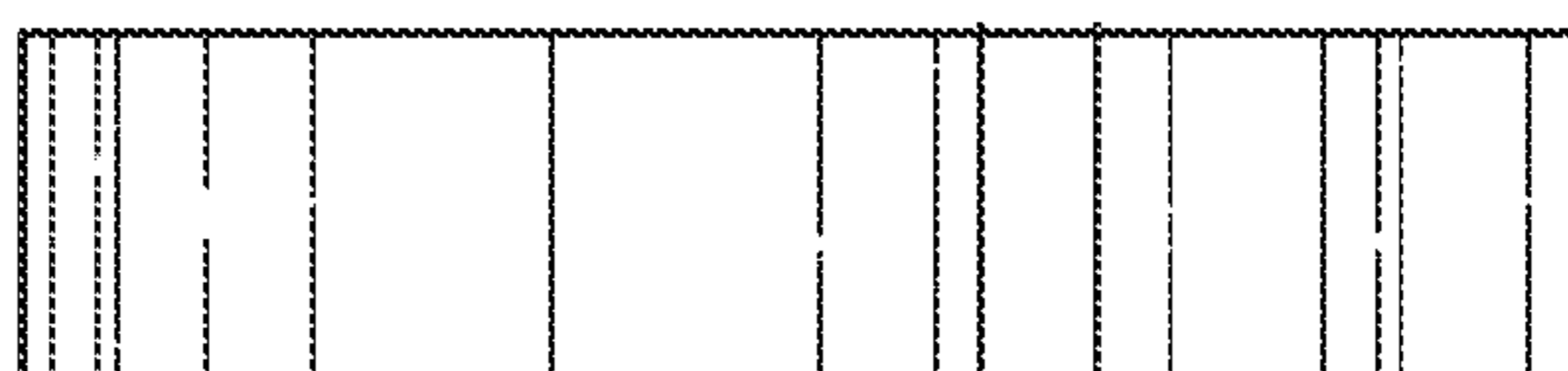

Fig. 7