



US00D680214S

(12) **United States Design Patent**
Eckstein et al.

(10) **Patent No.:** **US D680,214 S**
(45) **Date of Patent:** **** Apr. 16, 2013**

(54) **PART FOR INHALATION THERAPY
NEBULISER**

(75) Inventors: **Stefan Eckstein**, Munich (DE);
Manuela Moldenau, Munich (DE)

(73) Assignee: **PARI GmbH**, Starnberg (DE)

(**) Term: **14 Years**

(21) Appl. No.: **29/413,124**

(22) Filed: **Feb. 10, 2012**

Related U.S. Application Data

(63) Continuation of application No. 29/245,672, filed on
Dec. 28, 2005, now Pat. No. Des. 656,604.

(30) **Foreign Application Priority Data**

Jun. 28, 2005 (EM) 000 371 695

(51) **LOC (9) Cl.** **29-01**

(52) **U.S. Cl.**
USPC **D24/110**

(58) **Field of Classification Search** D24/110,
D24/129, 110.4, 110.5, 108, 127;
128/200.11-200.14, 200.24, 200.25
See application file for complete search history.

(56) **References Cited**

U.S. PATENT DOCUMENTS

3,353,536 A 11/1967 Bird et al.
3,395,703 A 8/1968 Chouinard et al.

(Continued)

Primary Examiner — Ian Simmons

Assistant Examiner — Eleni H Aldridge

(74) *Attorney, Agent, or Firm* — Wolf, Greenfield & Sacks,
P.C.

(57) **CLAIM**

The ornamental design for the part for inhalation therapy
nebuliser, as shown and described.

DESCRIPTION

FIG. 1 is a front elevational view of a first embodiment of the part for inhalation therapy nebuliser; FIG. 2 is a left side elevational view of the first embodiment; FIG. 3 is a right side elevational view of the first embodiment; FIG. 4 is a rear elevational view of the first embodiment; FIG. 5 is a top plan view of the first embodiment; FIG. 6 is a bottom plan view of the first embodiment; FIG. 7 is a perspective view of a second embodiment of the part for inhalation therapy nebuliser; FIG. 8 is a front elevational view of the second embodiment; FIG. 9 is a left side elevational view of the second embodiment; FIG. 10 is a right side elevational view of the second embodiment; FIG. 11 is a rear elevational view of the second embodiment; FIG. 12 is a top plan view of the second embodiment; FIG. 13 is a bottom plan view of the second embodiment; FIG. 14 is a perspective view of a third embodiment of the part for inhalation therapy nebuliser; FIG. 15 is a front elevational view of the third embodiment; FIG. 16 is left side elevational view of the third embodiment; FIG. 17 is a right side elevational view of the third embodiment; FIG. 18 is a rear elevational view of the third embodiment; FIG. 19 is top plan view of the third embodiment; FIG. 20 is a bottom plan view of the third embodiment; FIG. 21 is a perspective view of a fourth embodiment of the part for inhalation therapy nebuliser; FIG. 22 is a front elevational view of the fourth embodiment; FIG. 23 is a left side elevational view of the fourth embodiment; FIG. 24 is a right side elevational view of the fourth embodiment; FIG. 25 is rear elevational view of the fourth embodiment; FIG. 26 is a top plan view of the fourth embodiment; and, FIG. 27 is a bottom plan view of the fourth embodiment. The first, second and third embodiments as illustrated in FIGS. 1-20 are lined for color to show a contrasting color on some portion of the part for inhalation therapy nebuliser, but the color lining is not otherwise a portion of the design. The broken lines in FIGS. 1-27 are included for the purpose of illustrating portions of the part for inhalation therapy nebuliser that form no part of the claimed design.

1 Claim, 4 Drawing Sheets

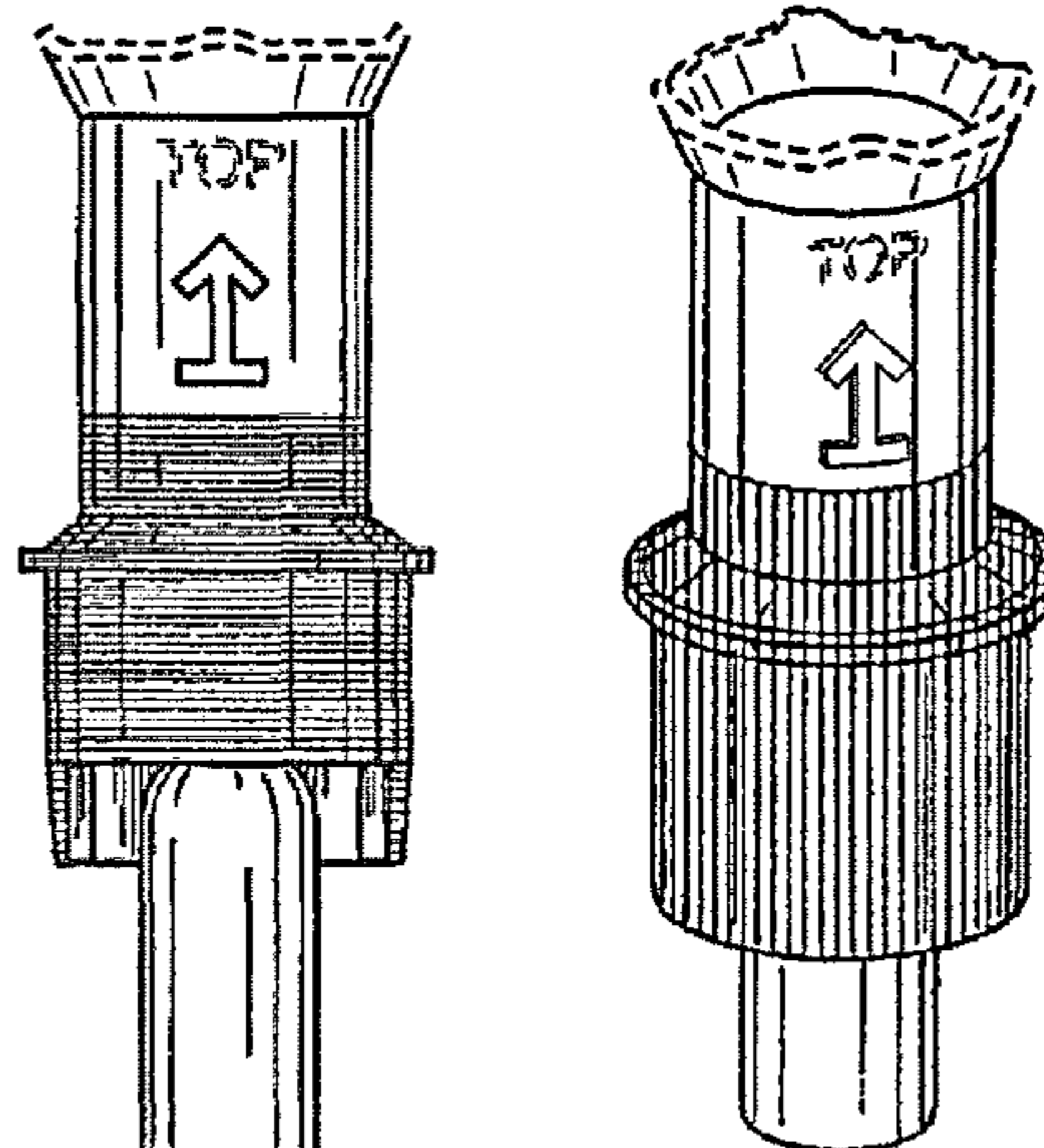

US D680,214 S

Page 2

U.S. PATENT DOCUMENTS

3,572,660	A	3/1971	Mahon et al.				
D239,021	S	* 3/1976	D'Alo	D24/129	D411,616	S	6/1999 Retallick, III
D244,057	S	4/1977	Aul et al.		D473,646	S	* 4/2003 Baillargeon et al. D24/129
4,253,468	A	3/1981	Lehmbeck		D473,941	S	* 4/2003 Cise et al. D24/129
4,595,002	A	6/1986	Michaels et al.		D476,731	S	* 7/2003 Cise et al. D24/110
4,767,576	A	8/1988	Bagwell		6,681,767	B1	1/2004 Patton et al.
D315,602	S	3/1991	Howe		D486,909	S	2/2004 Cise et al.
D331,281	S	11/1992	Levine		D638,117	S	5/2011 Eckstein et al.
D337,157	S	7/1993	Ortiz		D656,604	S	* 3/2012 Eckstein et al. D24/110
D340,976	S	11/1993	Garcia		2002/0134384	A1	9/2002 Bienvenu et al.

* cited by examiner

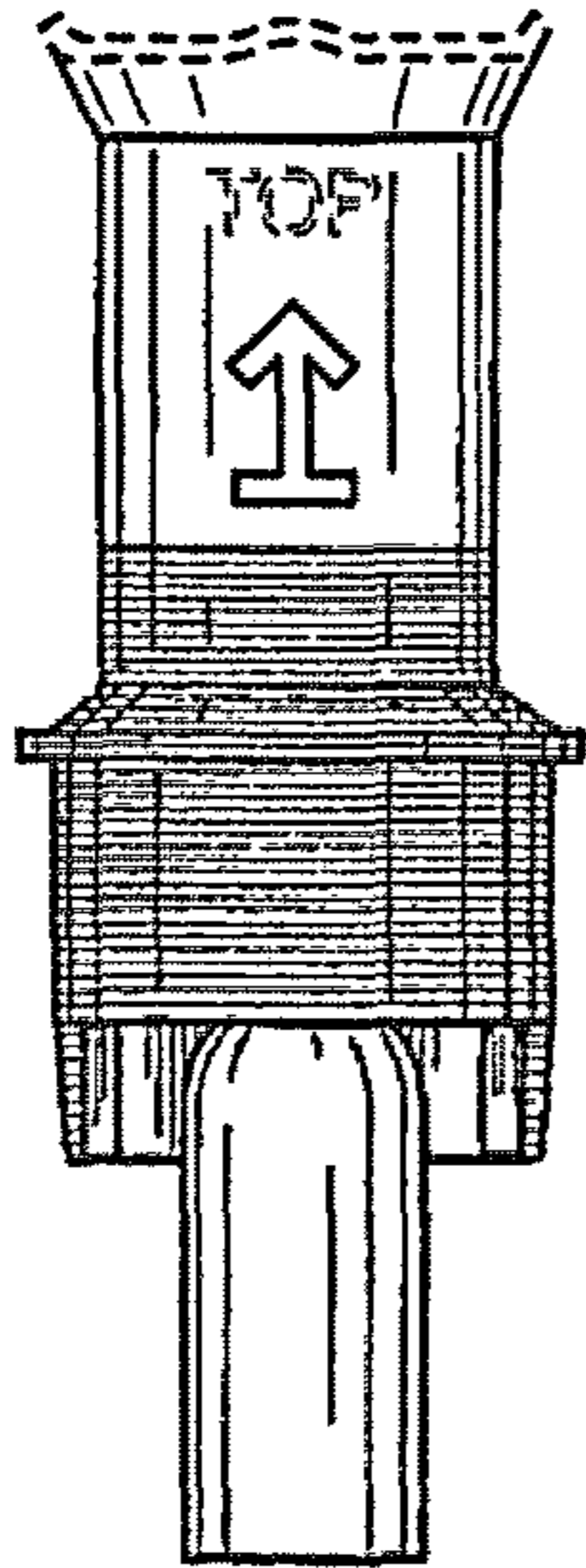

FIG. 1

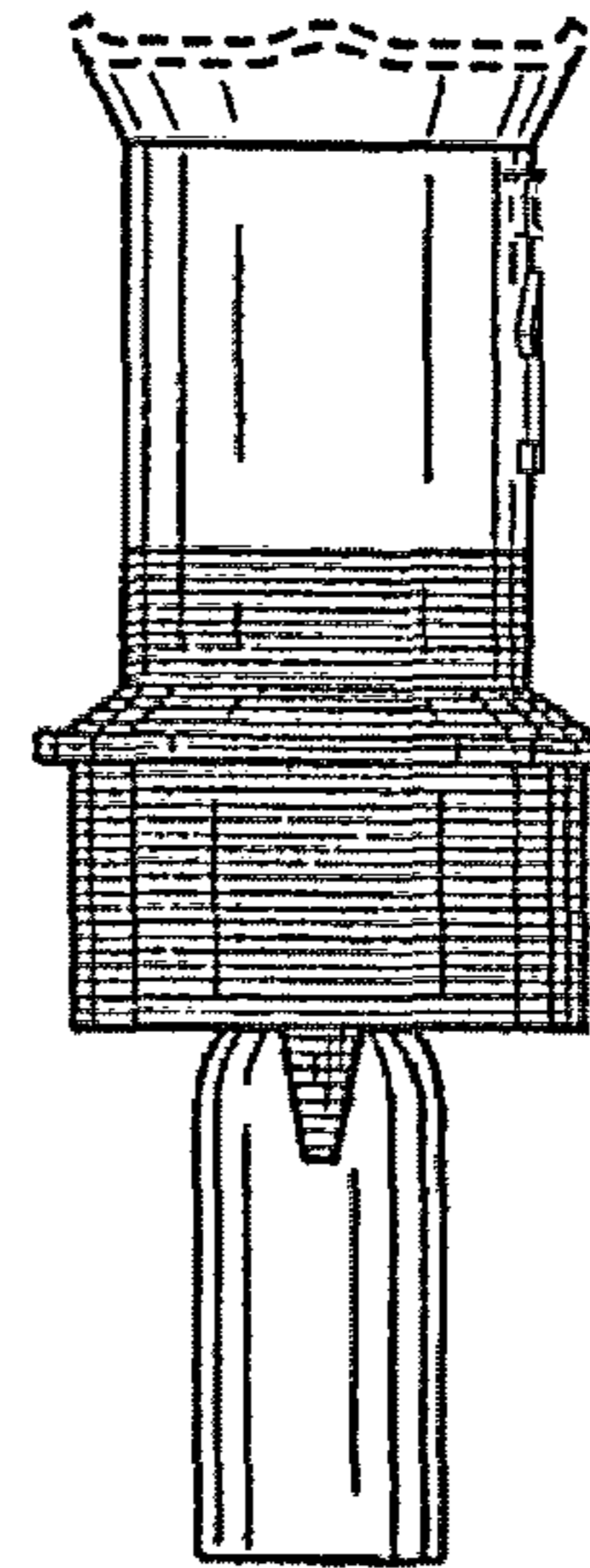

FIG. 2

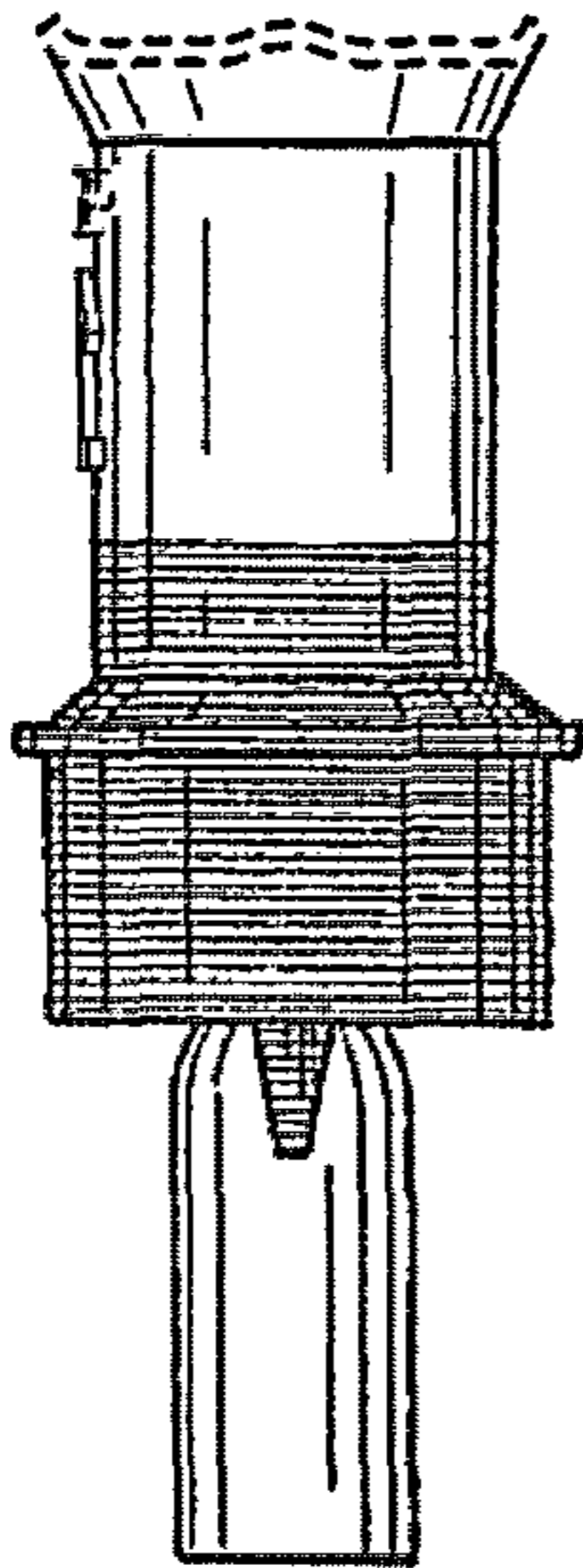

FIG. 3

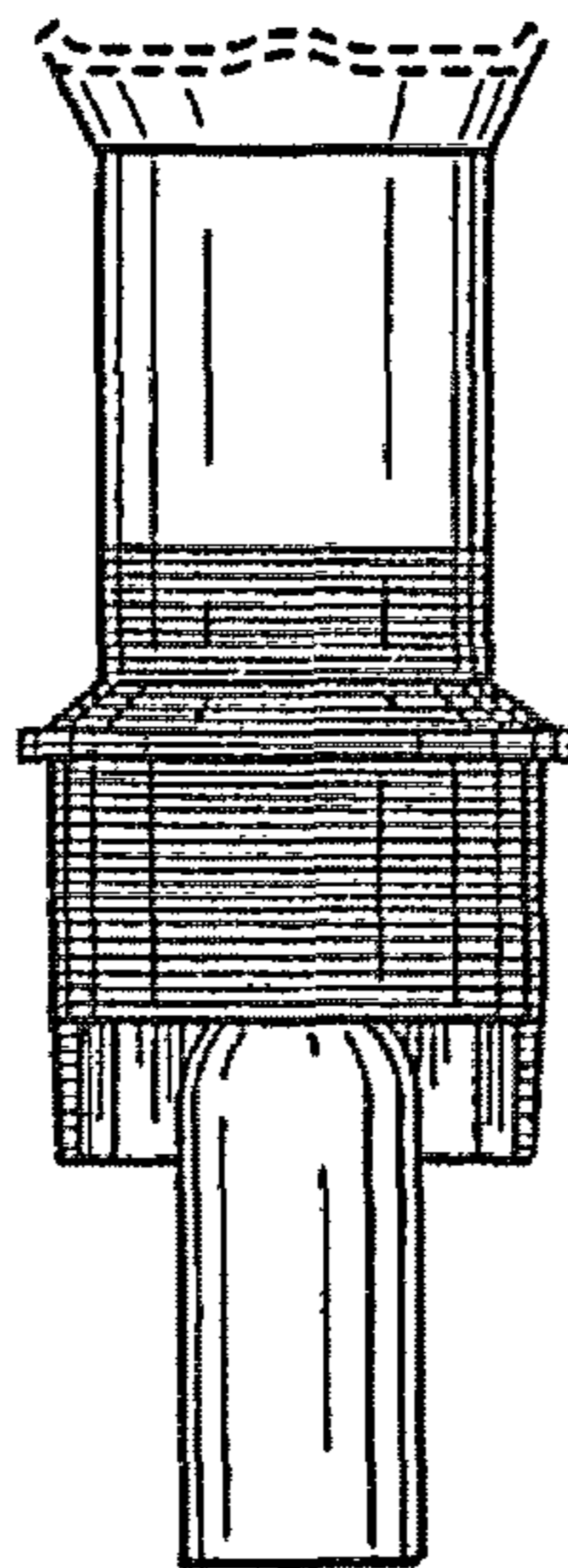

FIG. 4

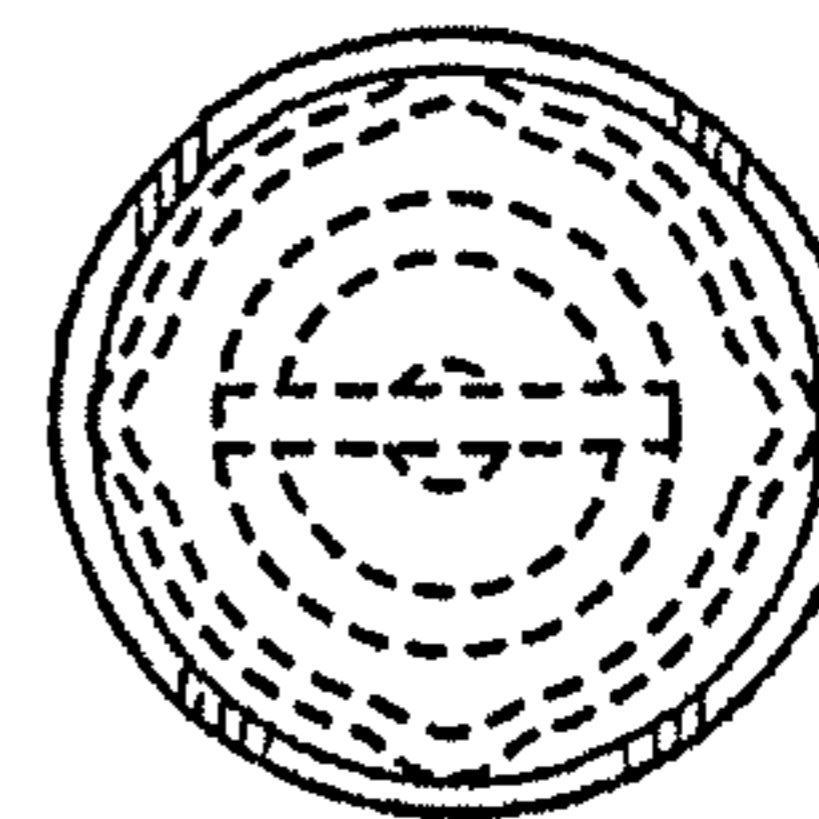

FIG. 5

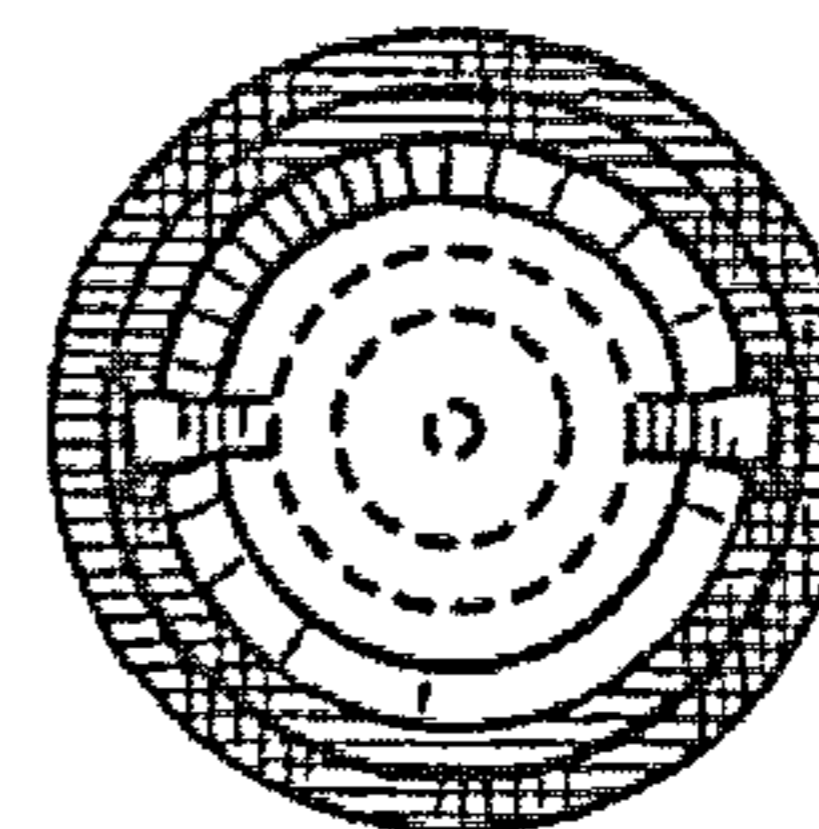

FIG. 6

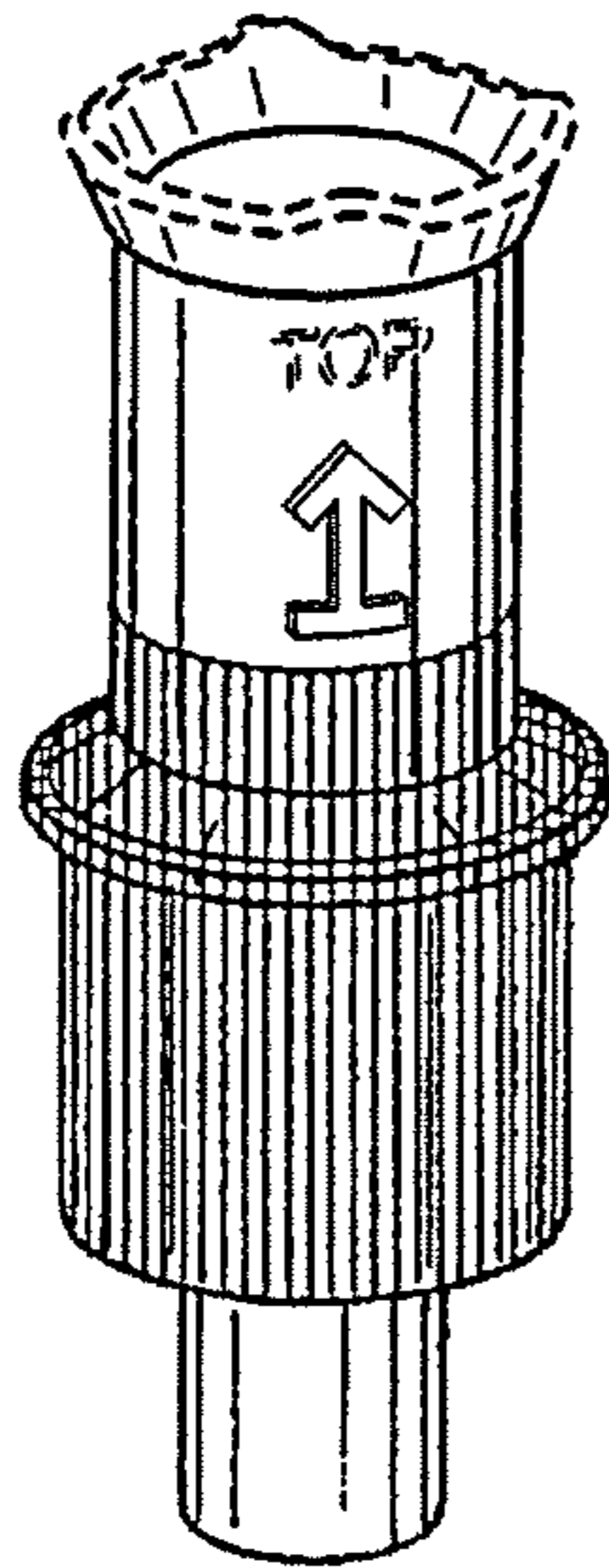

FIG. 7

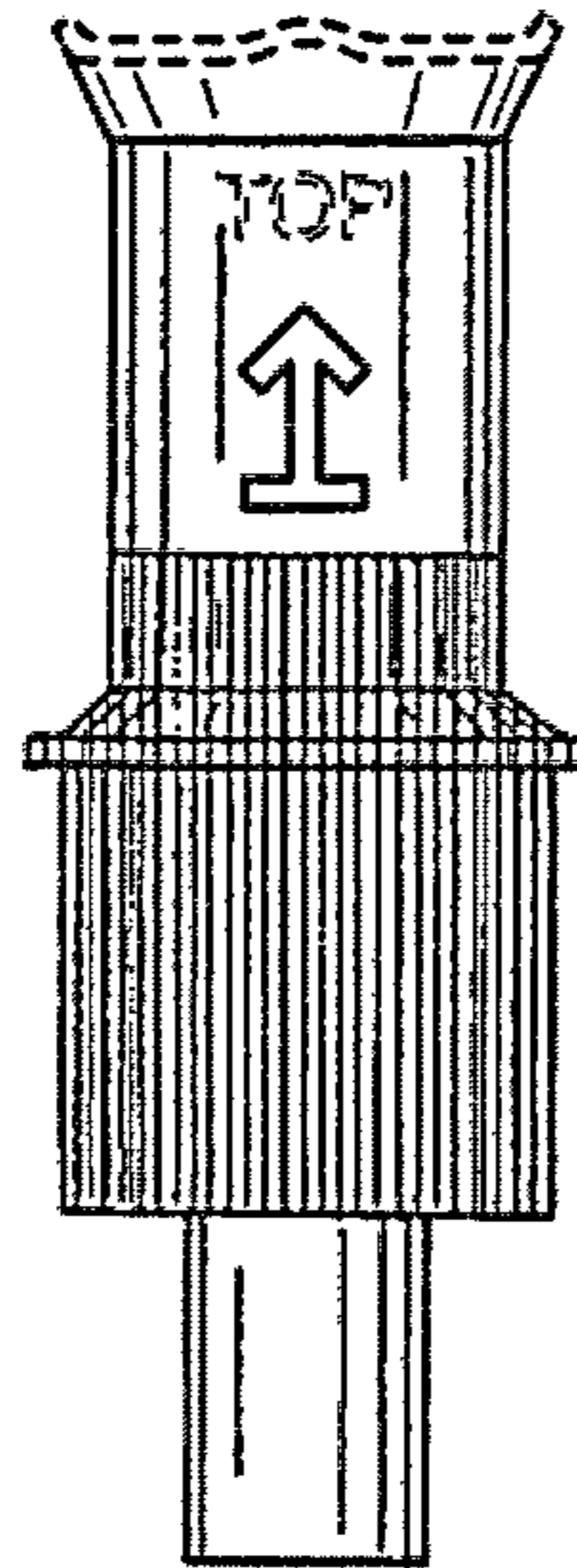

FIG. 8

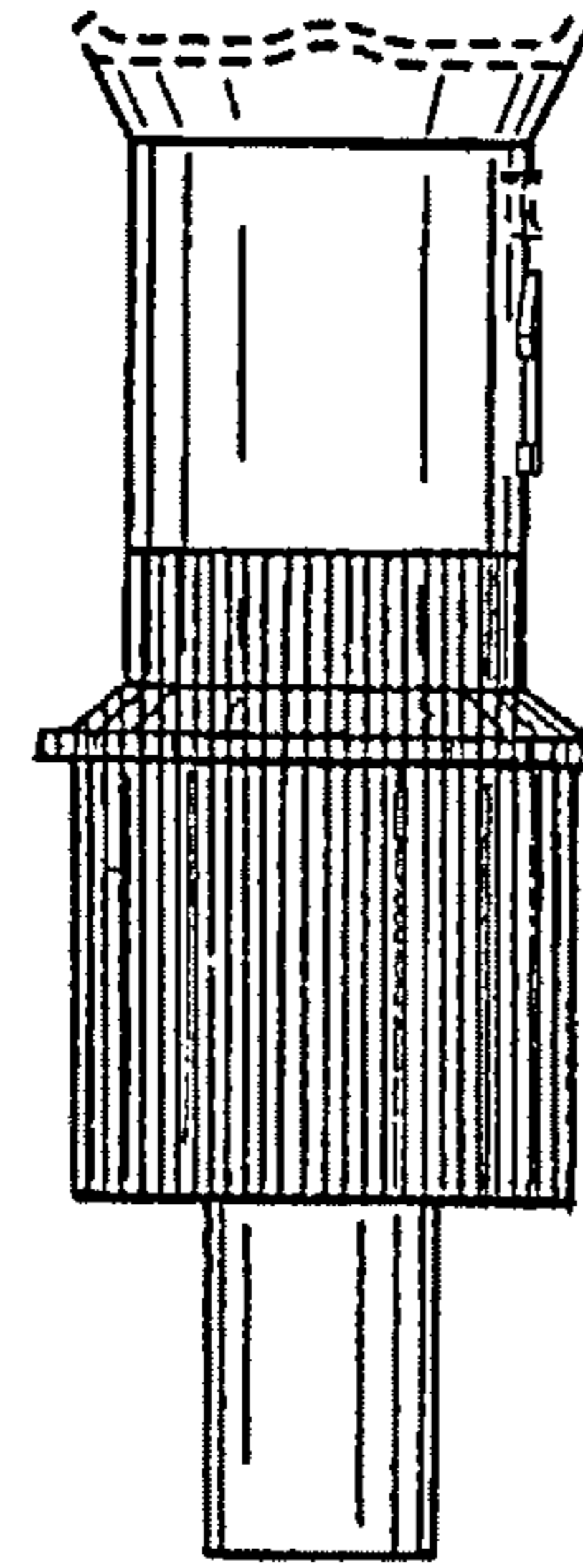

FIG. 9

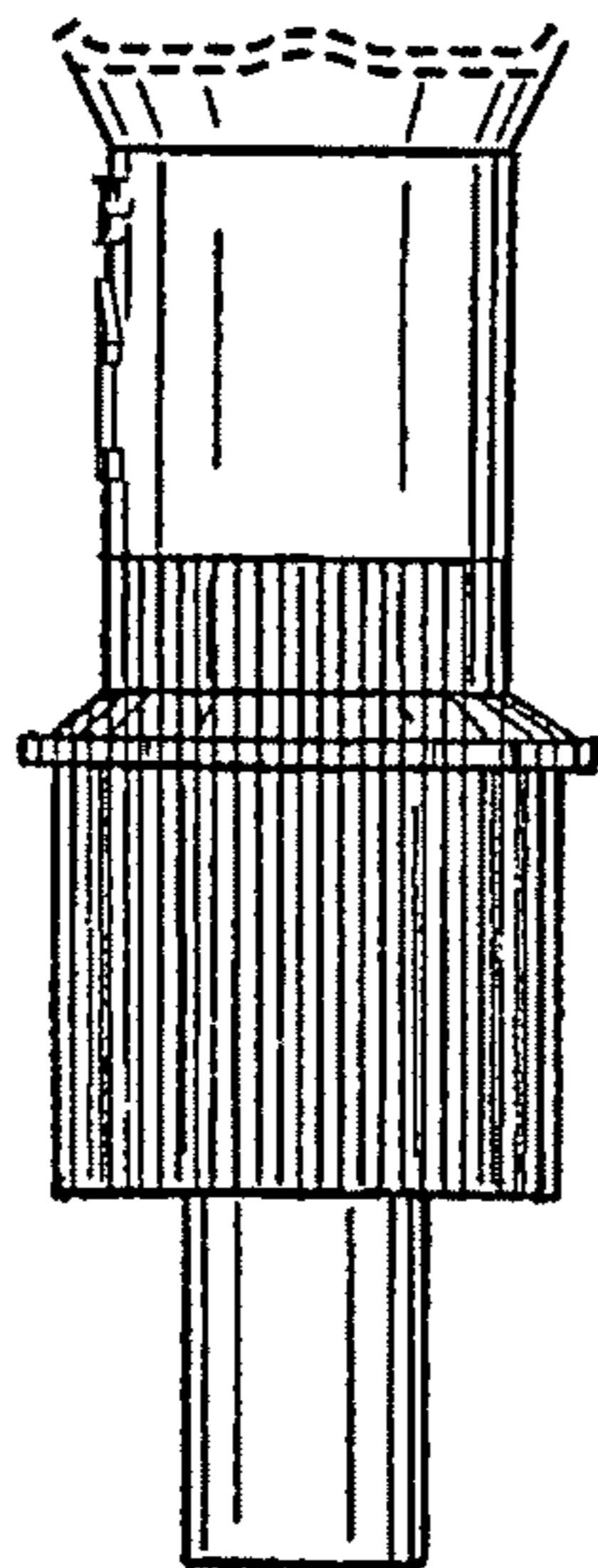

FIG. 10

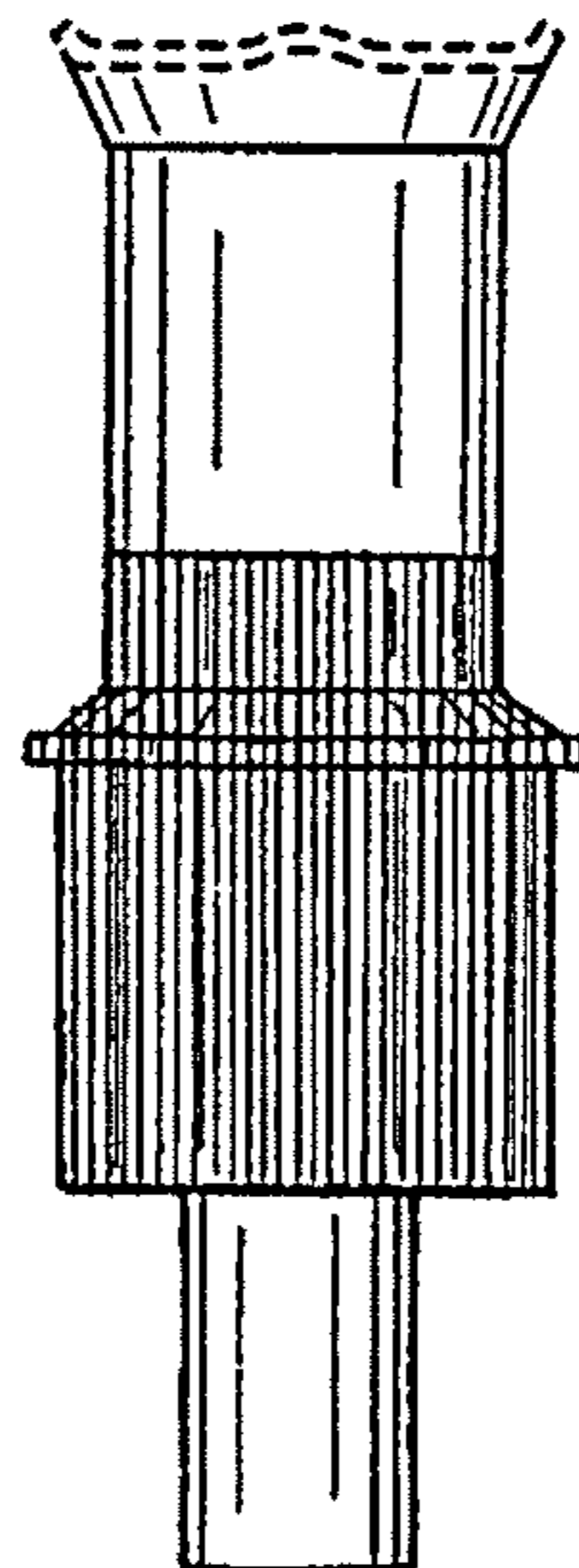

FIG. 11

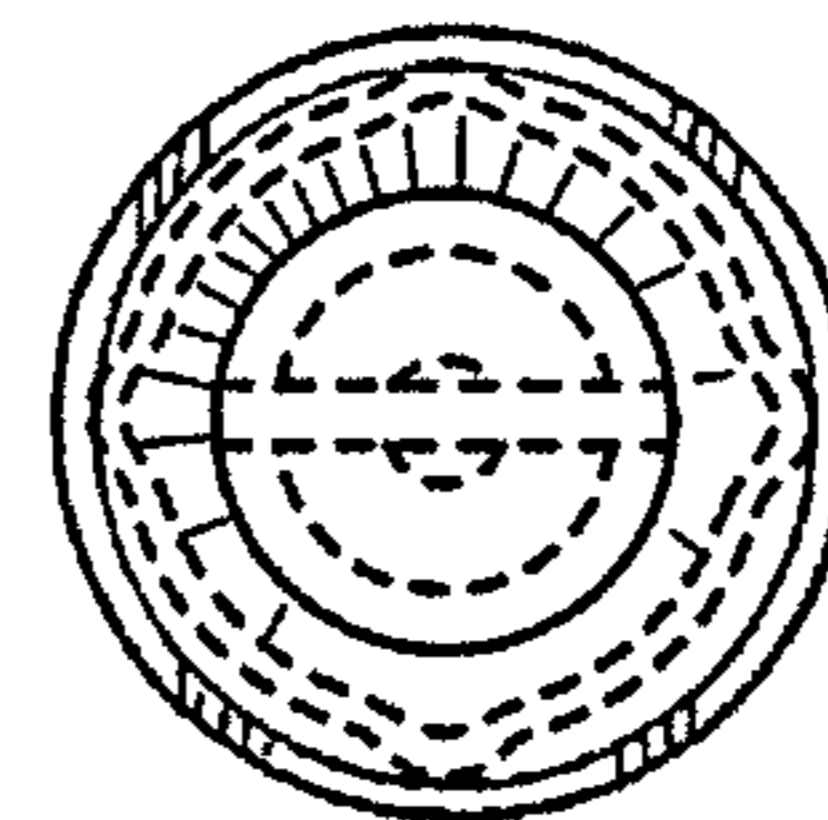

FIG. 12

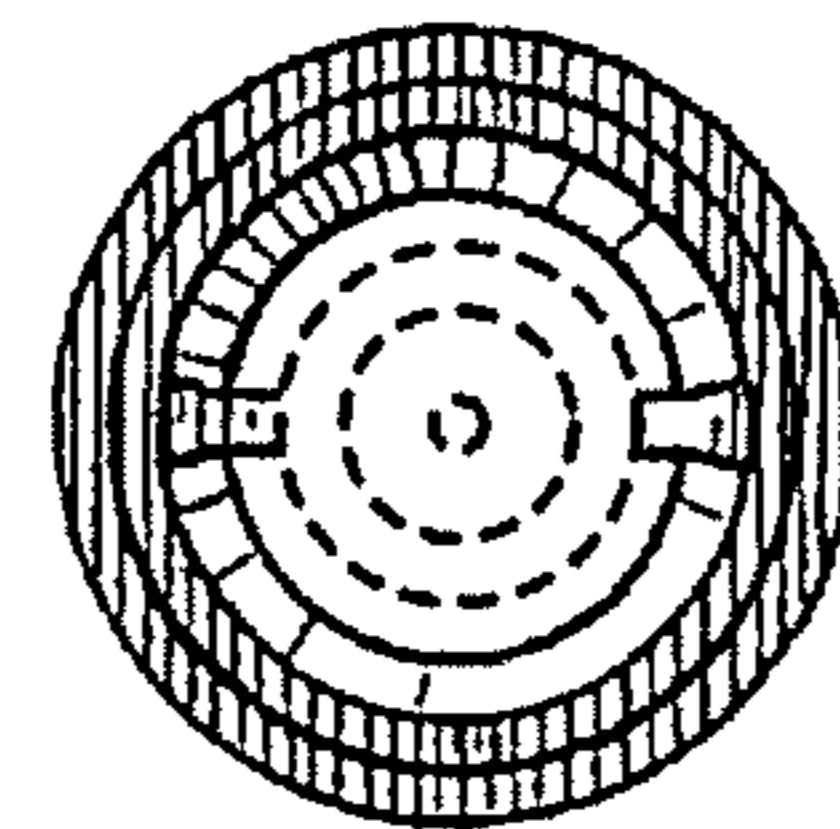

FIG. 13

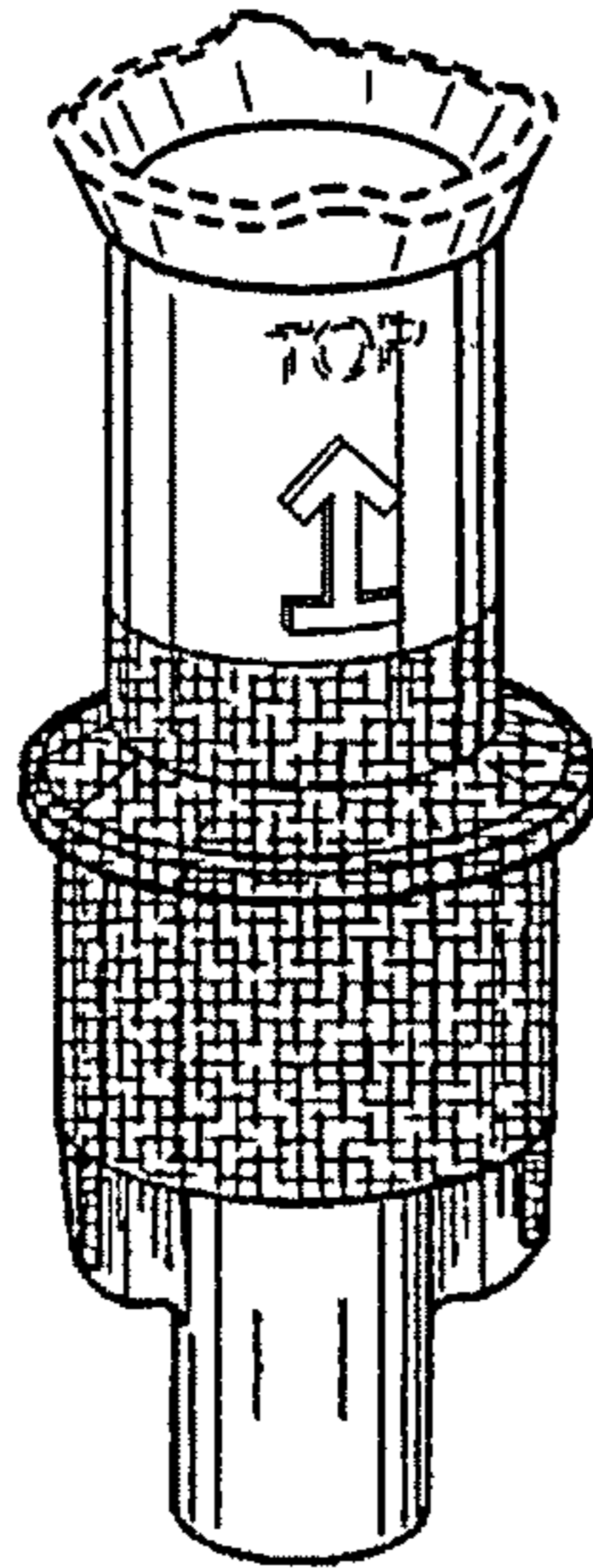

FIG. 14

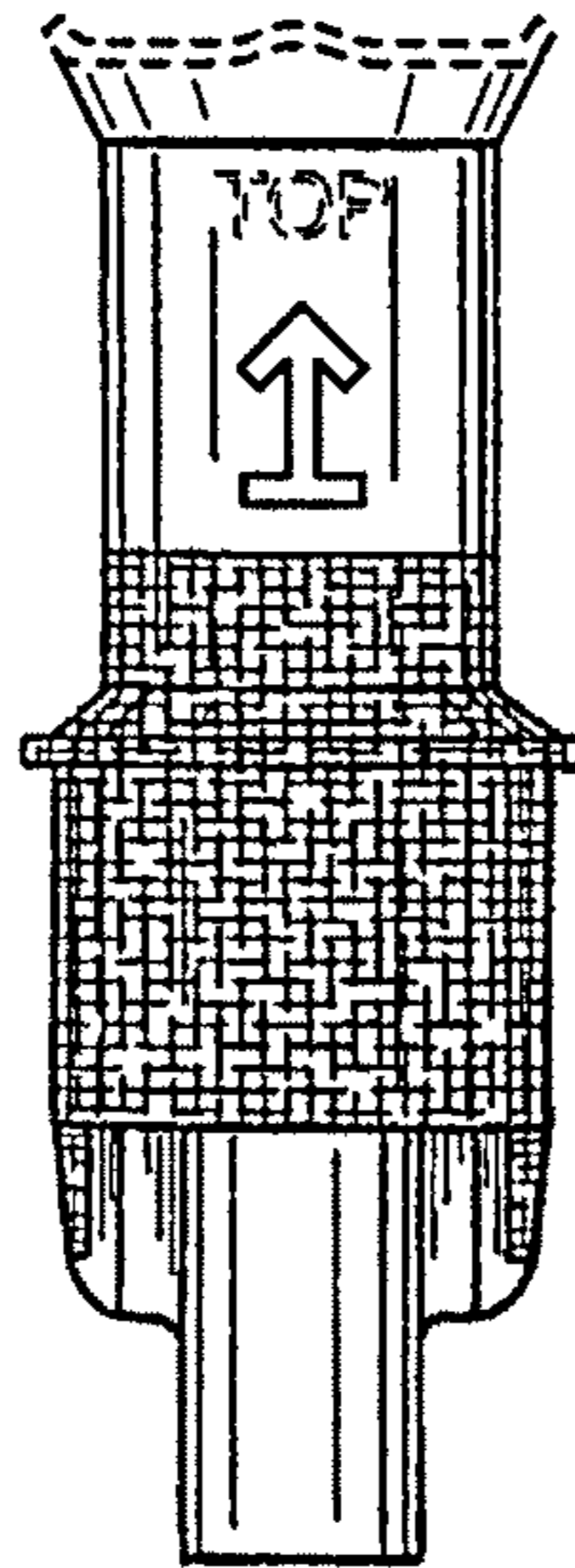

FIG. 15

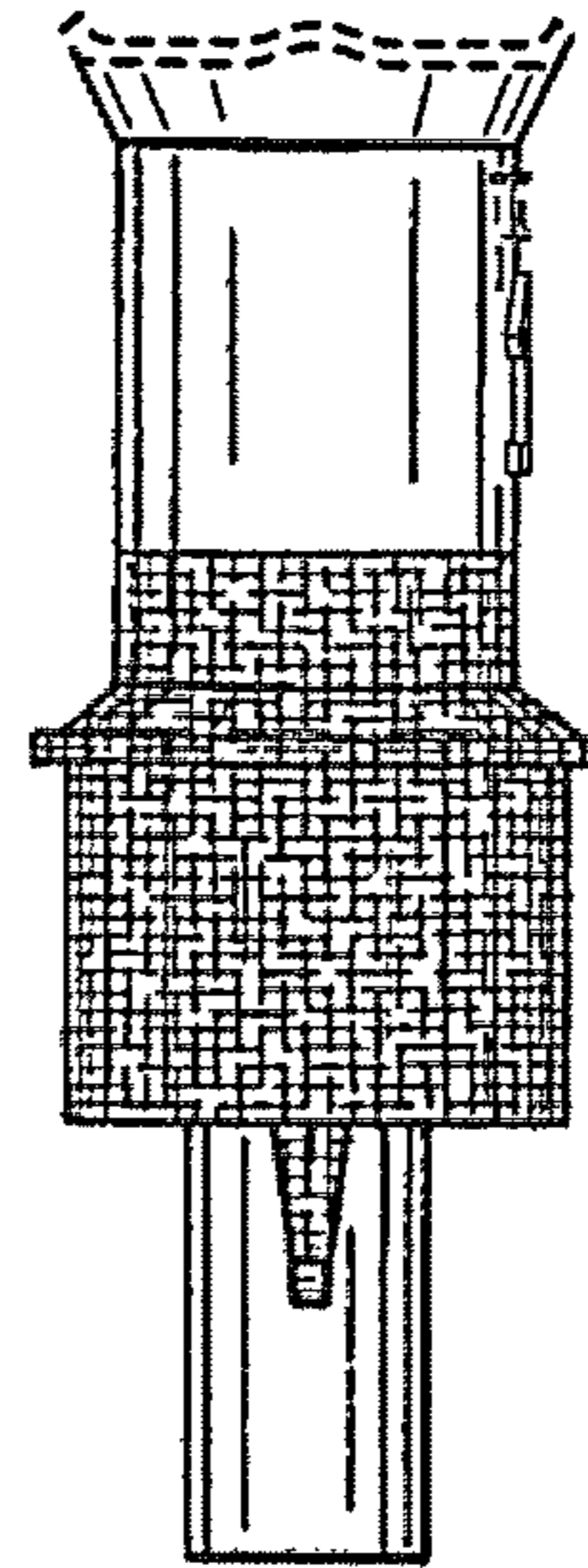

FIG. 16

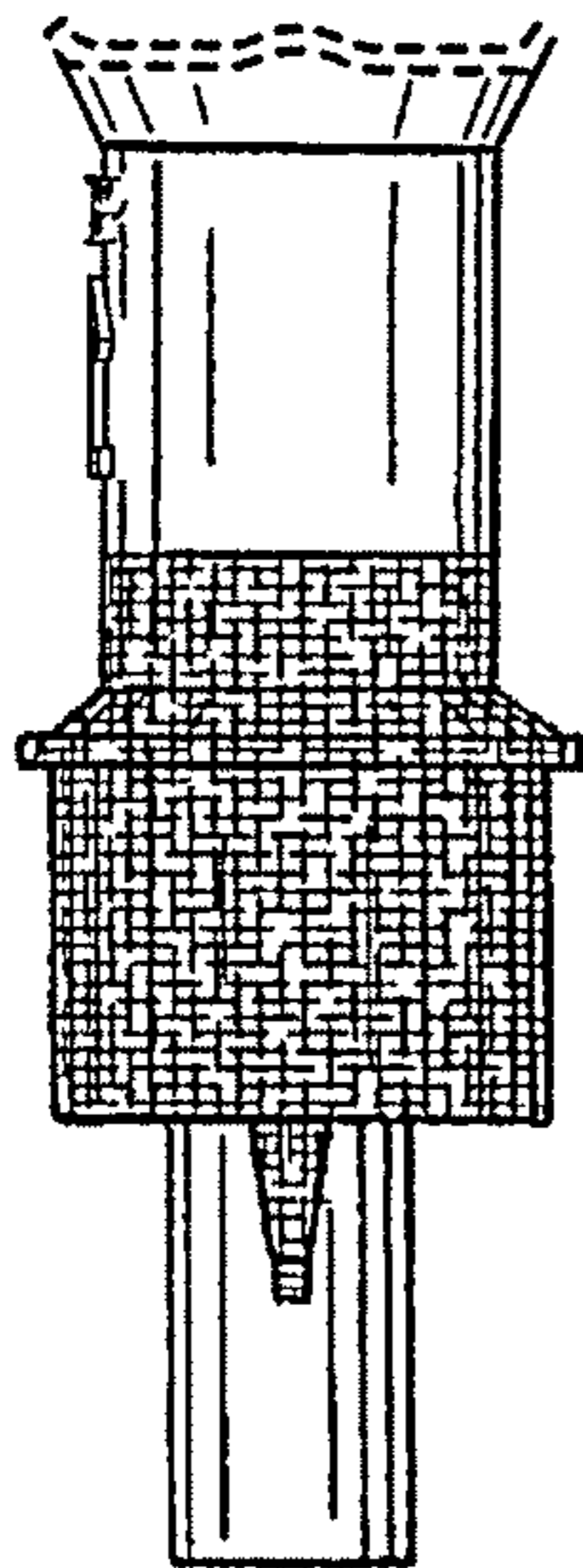

FIG. 17

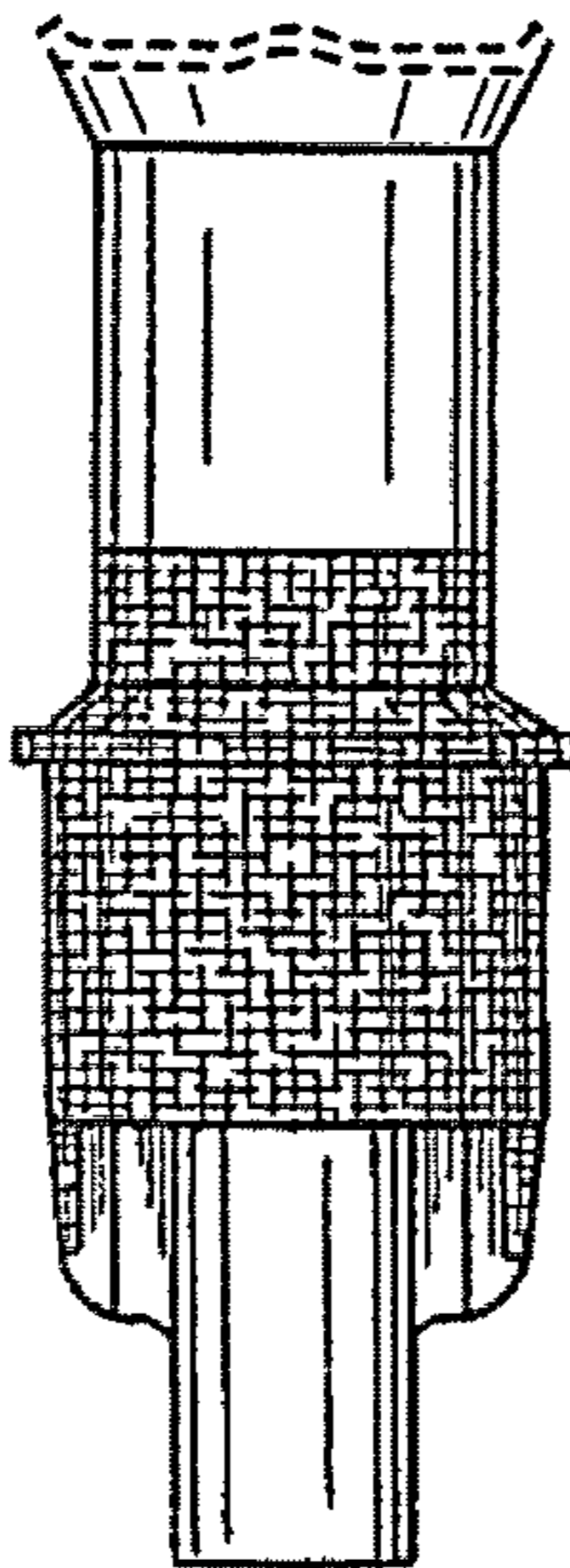

FIG. 18

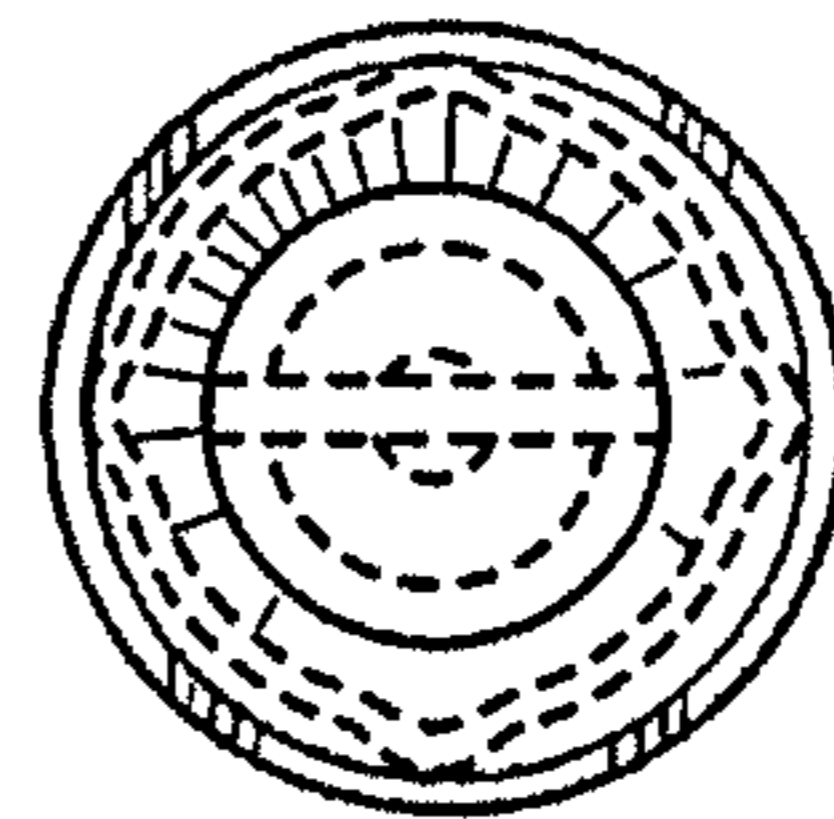

FIG. 19

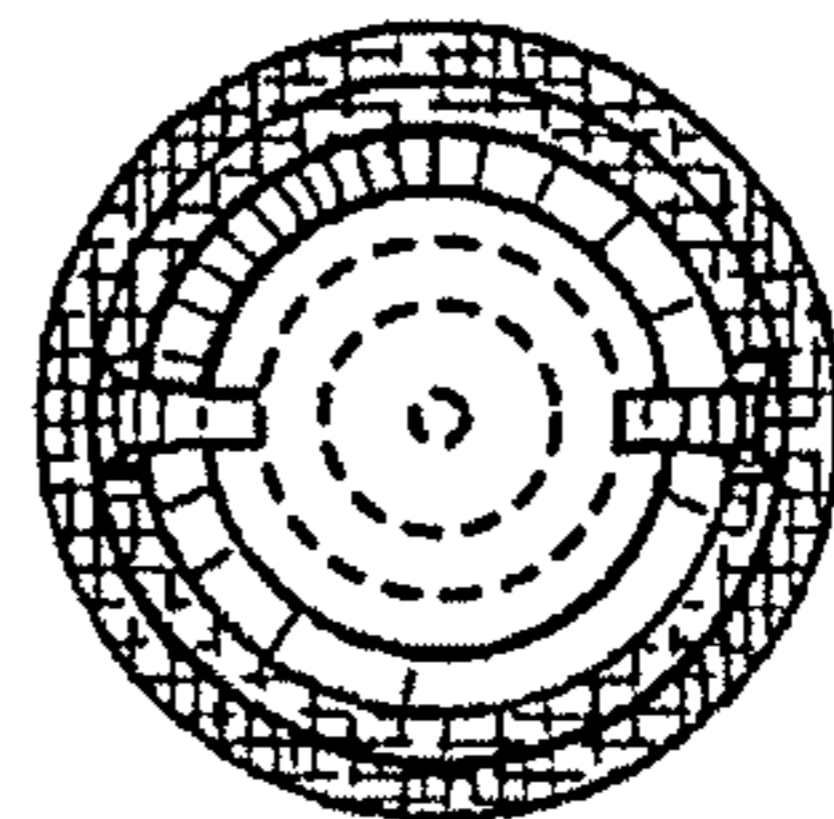

FIG. 20

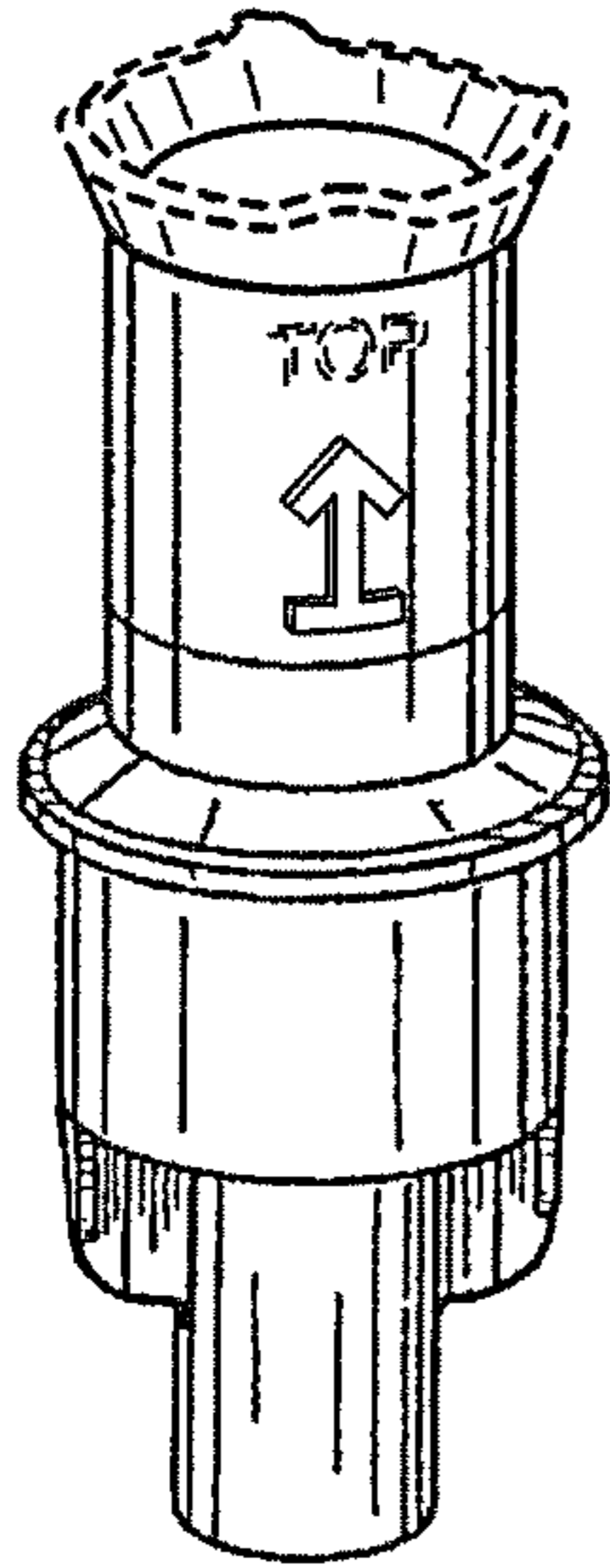

FIG. 21

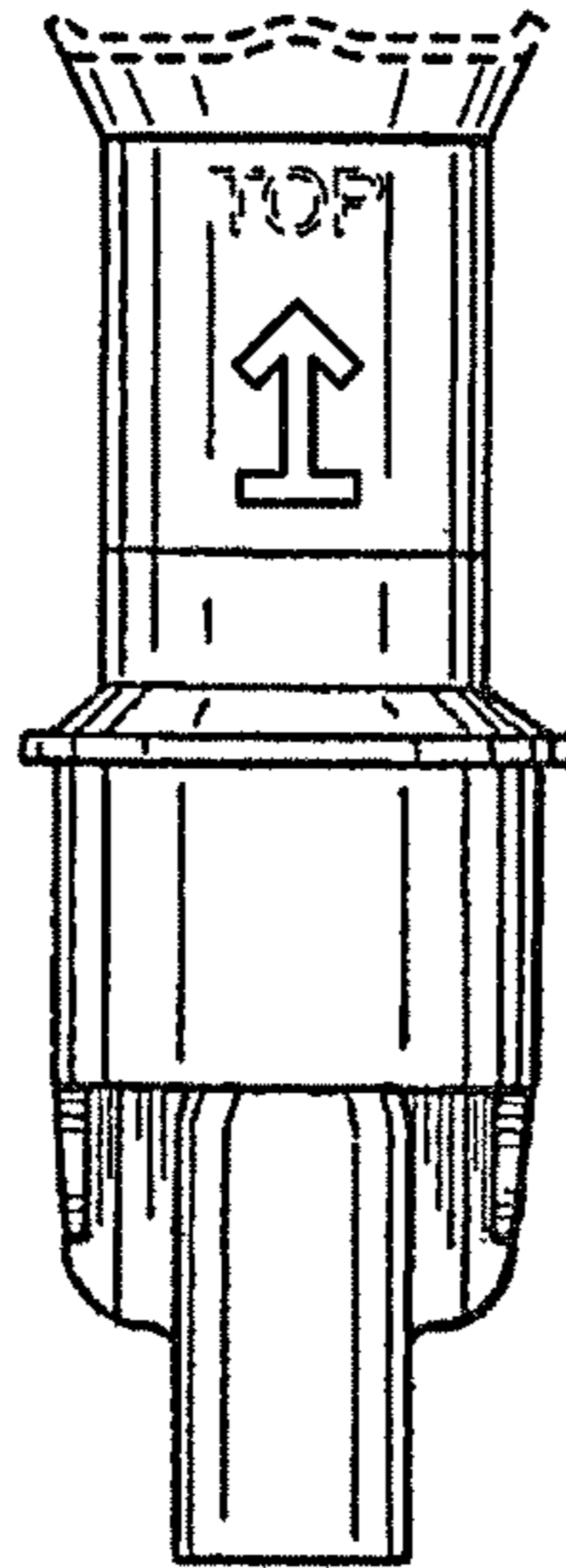

FIG. 22

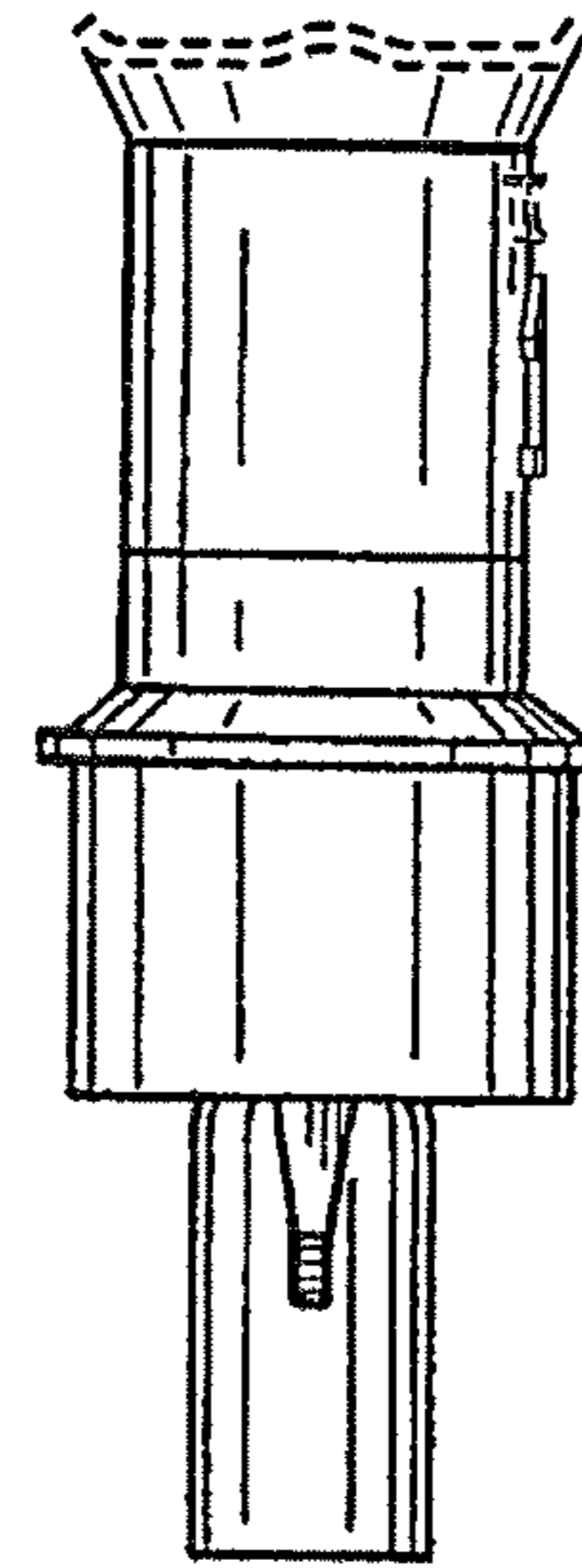

FIG. 23

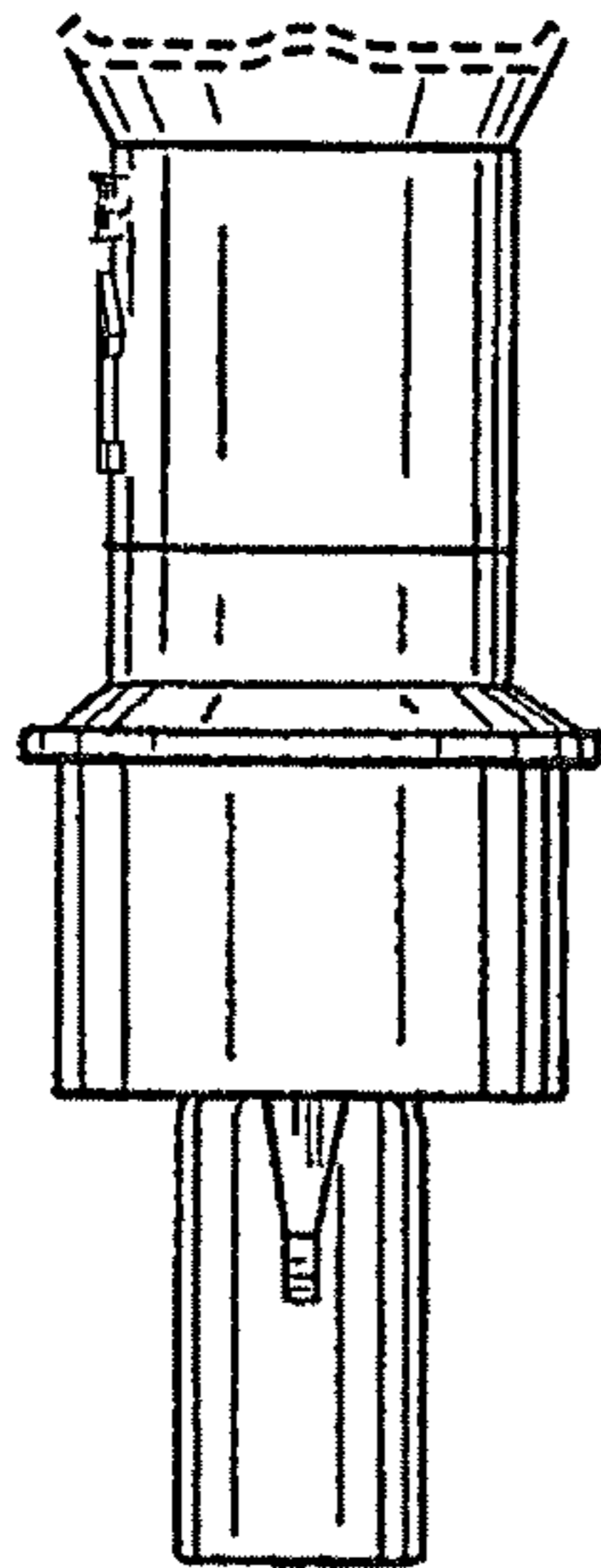

FIG. 24

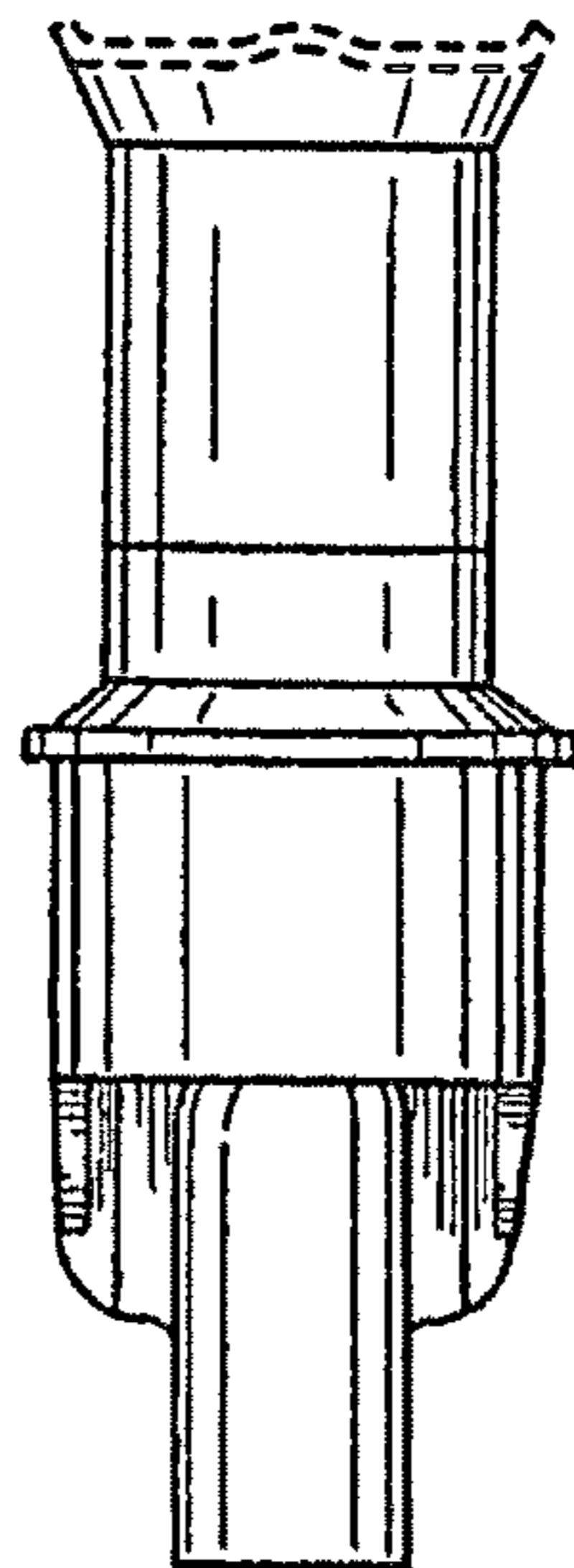

FIG. 25

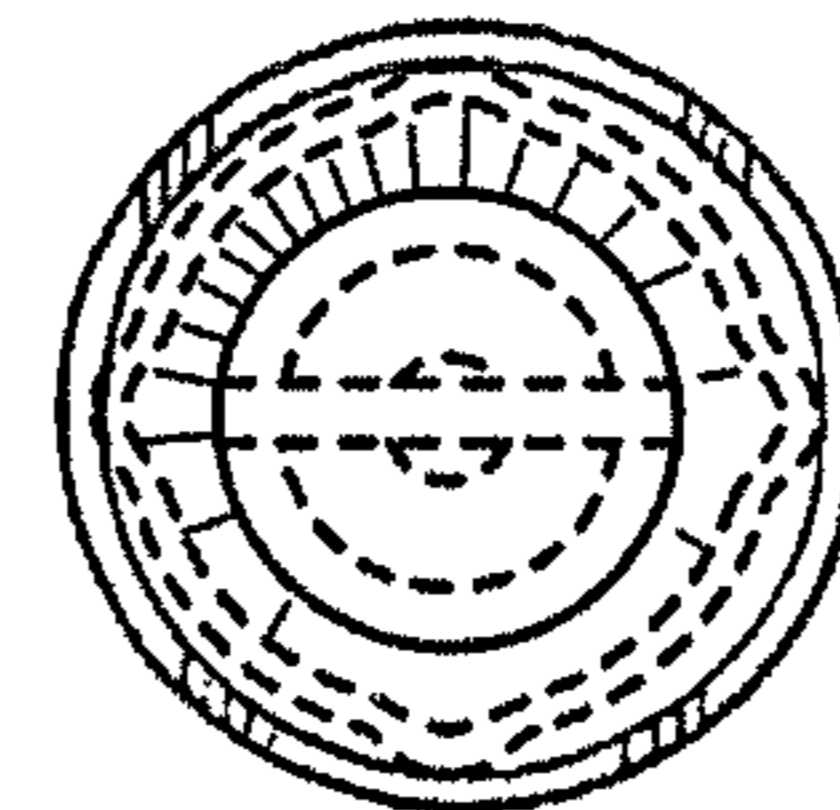

FIG. 26

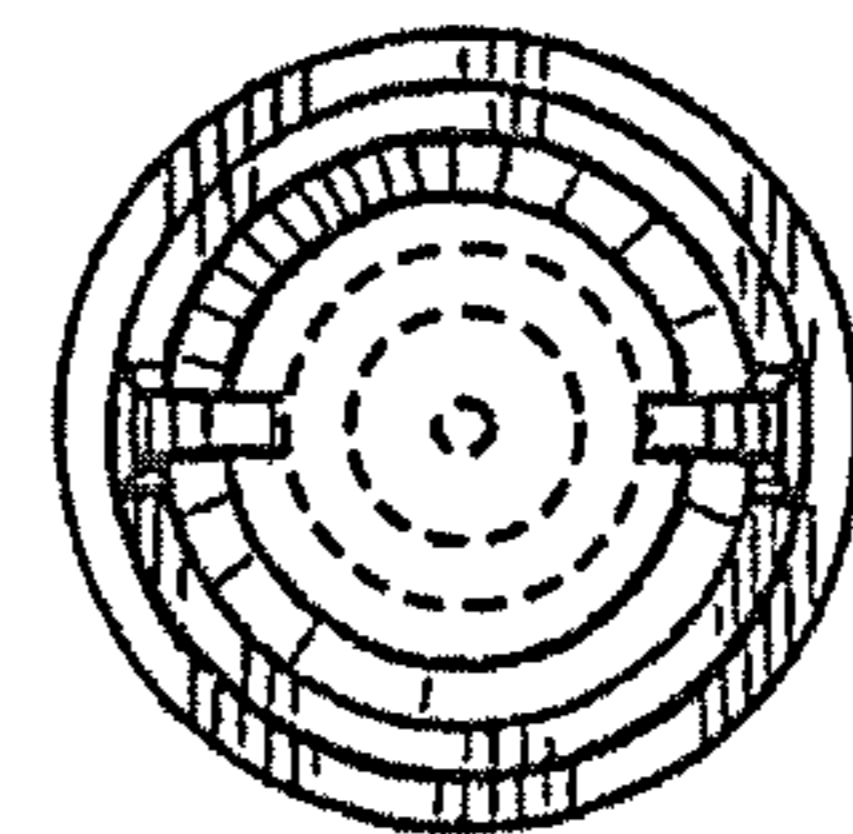

FIG. 27