



US00D680202S

(12) **United States Design Patent**
Figurski et al.

(10) **Patent No.:** **US D680,202 S**

(45) **Date of Patent:** **** Apr. 16, 2013**

(54) **HAND DRYER AND BASIN**

(56) **References Cited**

(75) Inventors: **Mark A. Figurski**, Hartland, WI (US);
Jason M. Renner, Greenfield, WI (US);
John M. Loberger, Germantown, WI
(US); **Kevin M. Kohlwey**, Fort
Washington, WI (US); **Cory R.**
Boudreau, Madison, WI (US); **Scott I.**
Biba, Highland, WI (US); **Nicholas S.**
Reback, Madison, WI (US)

U.S. PATENT DOCUMENTS

D200,896	S	*	4/1965	Gallup	D28/54.1
D225,403	S	*	12/1972	Brendgord	D23/284
5,265,284	A	*	11/1993	Dottori et al.	4/630
D387,144	S	*	12/1997	Flaherty	D23/308
D481,826	S	*	11/2003	Martinuzzo et al.	D28/54.1
D538,898	S	*	3/2007	Trepanier	D23/286
D588,676	S	*	3/2009	Loberger et al.	D23/271

* cited by examiner

Primary Examiner — Robert Delehanty

(73) Assignee: **Bradley Fixtures Corporation**,
Menomonee Falls, WI (US)

(74) *Attorney, Agent, or Firm* — Boyle Fredrickson S.C.

(**) Term: **14 Years**

(57) **CLAIM**

The ornamental design for a hand dryer and basin, substan-
tially as shown and described.

(21) Appl. No.: **29/432,263**

DESCRIPTION

(22) Filed: **Sep. 14, 2012**

Related U.S. Application Data

(62) Division of application No. 29/424,760, filed on Jun.
15, 2012.

(51) **LOC (9) Cl.** **23-02**

(52) **U.S. Cl.**
USPC **D23/308**

(58) **Field of Classification Search** D23/271,
D23/284, 286, 308; 4/662, 619, 630, 638;
D28/54.1; D24/185

See application file for complete search history.

FIG. 1 is a raised perspective view of the in situ lavatory basin;
FIG. 2 is a top plan view of the in situ lavatory basin of FIG.
1;
FIG. 3 is a top plan view of the lavatory basin of FIG. 1;
FIG. 4 is a front elevation view of the lavatory basin of FIG.
1;
FIG. 5 is a left-side elevation view of the lavatory basin of
FIG. 1;
FIG. 6 is a right-side elevation view of the lavatory basin of
FIG. 1; and,
FIG. 7 is a bottom plan view of the lavatory basin of FIG. 1.
The broken lines represent environmental structure and form
no part of the claimed design.

1 Claim, 6 Drawing Sheets

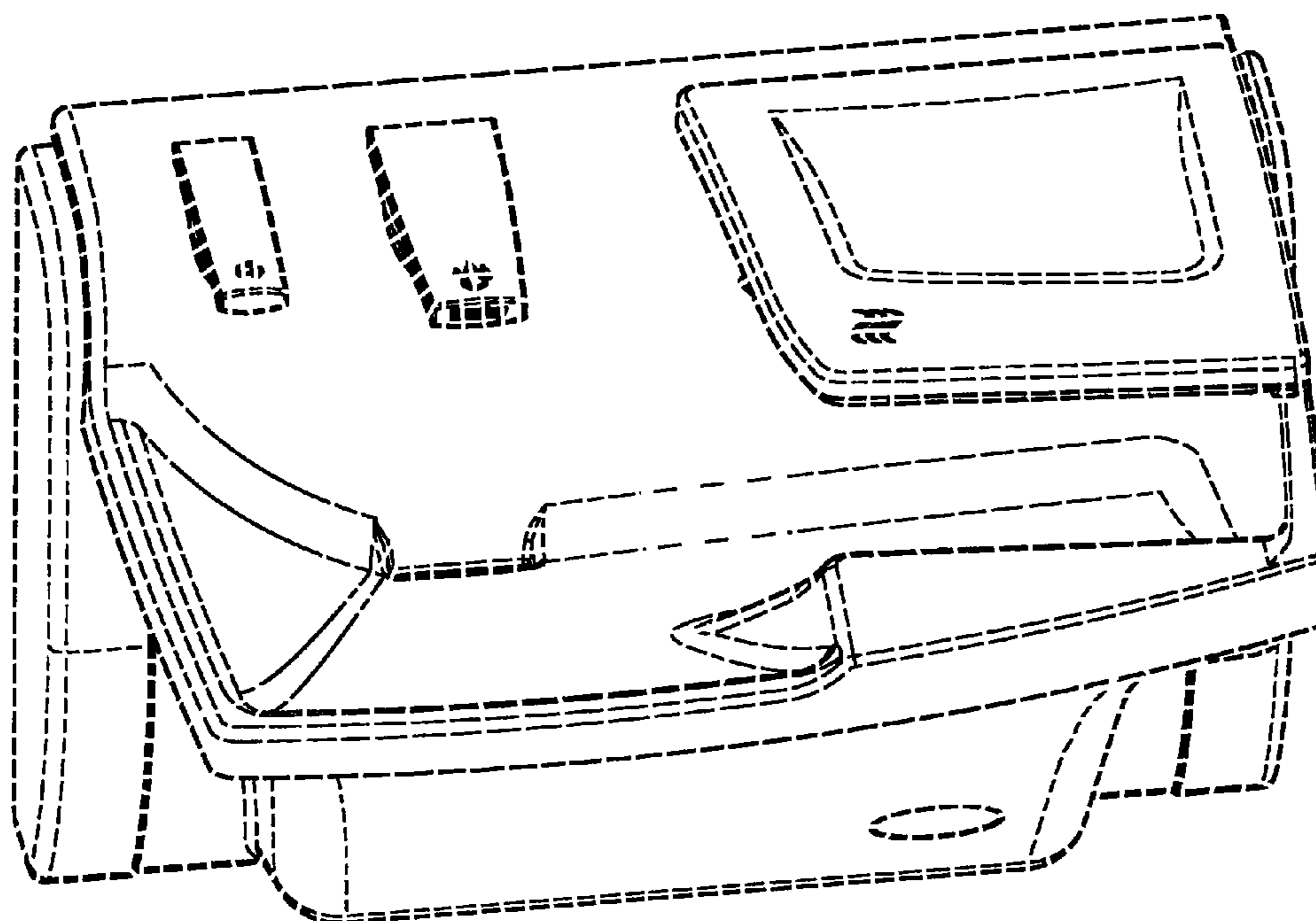

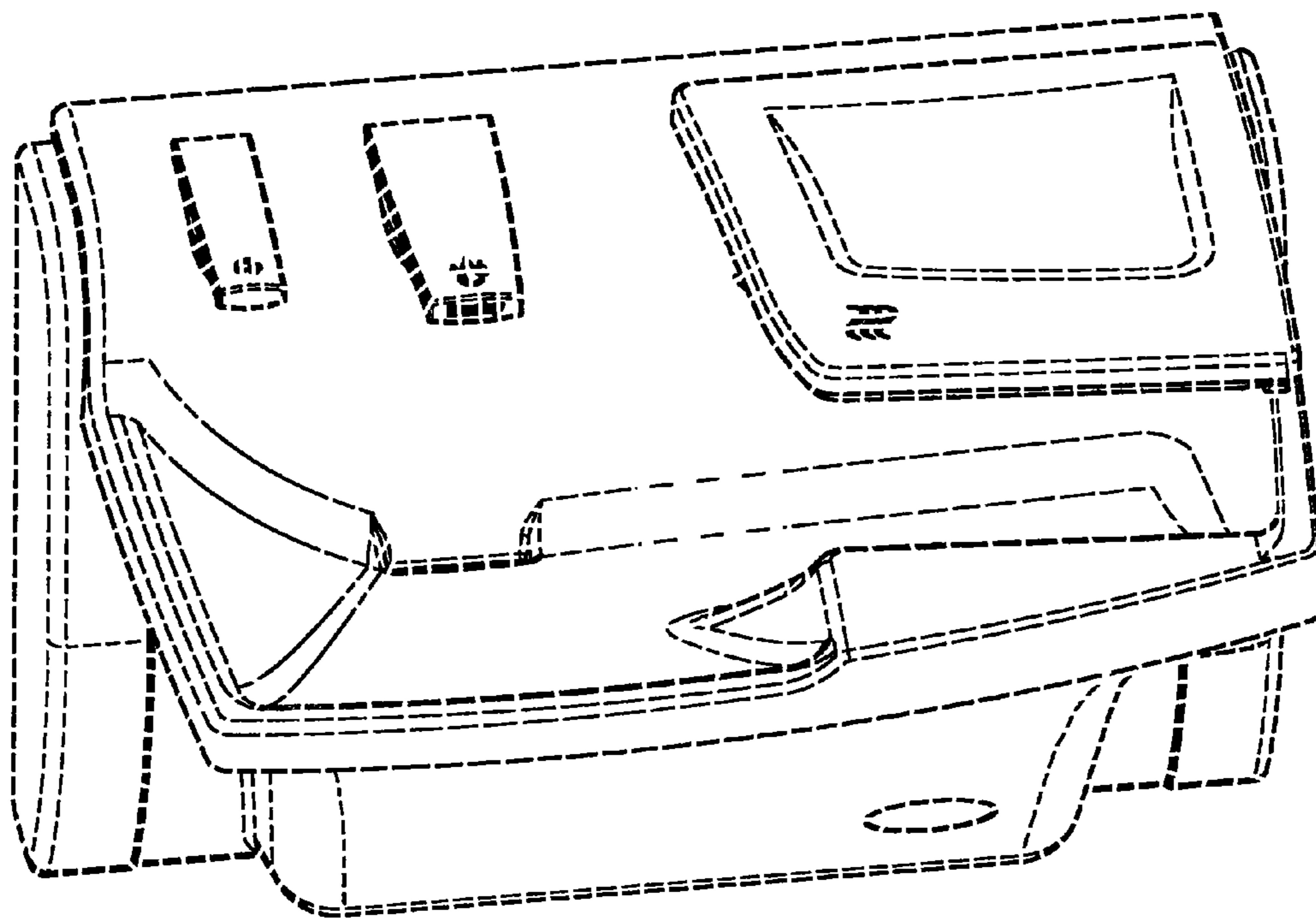

FIG. 1

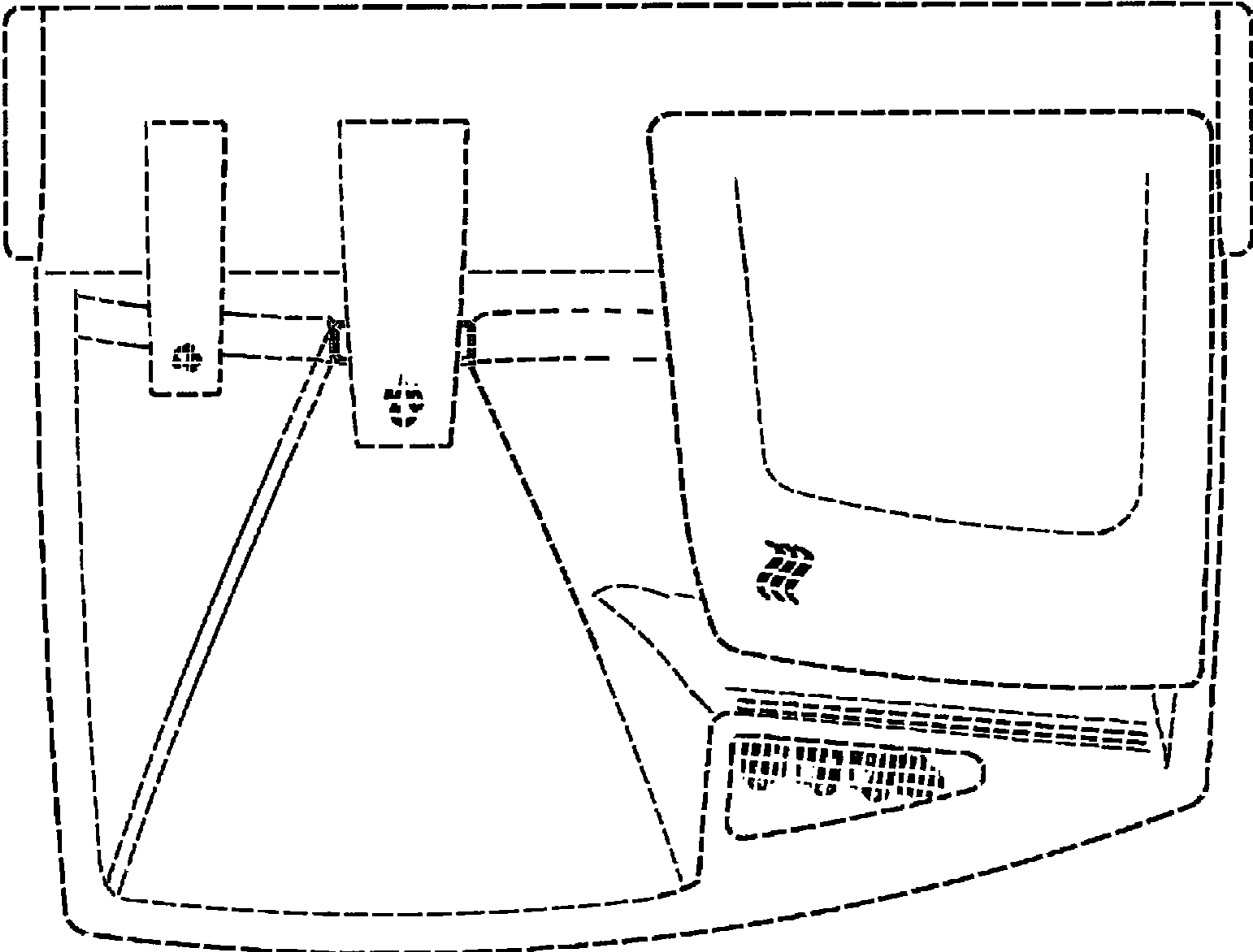

FIG. 2

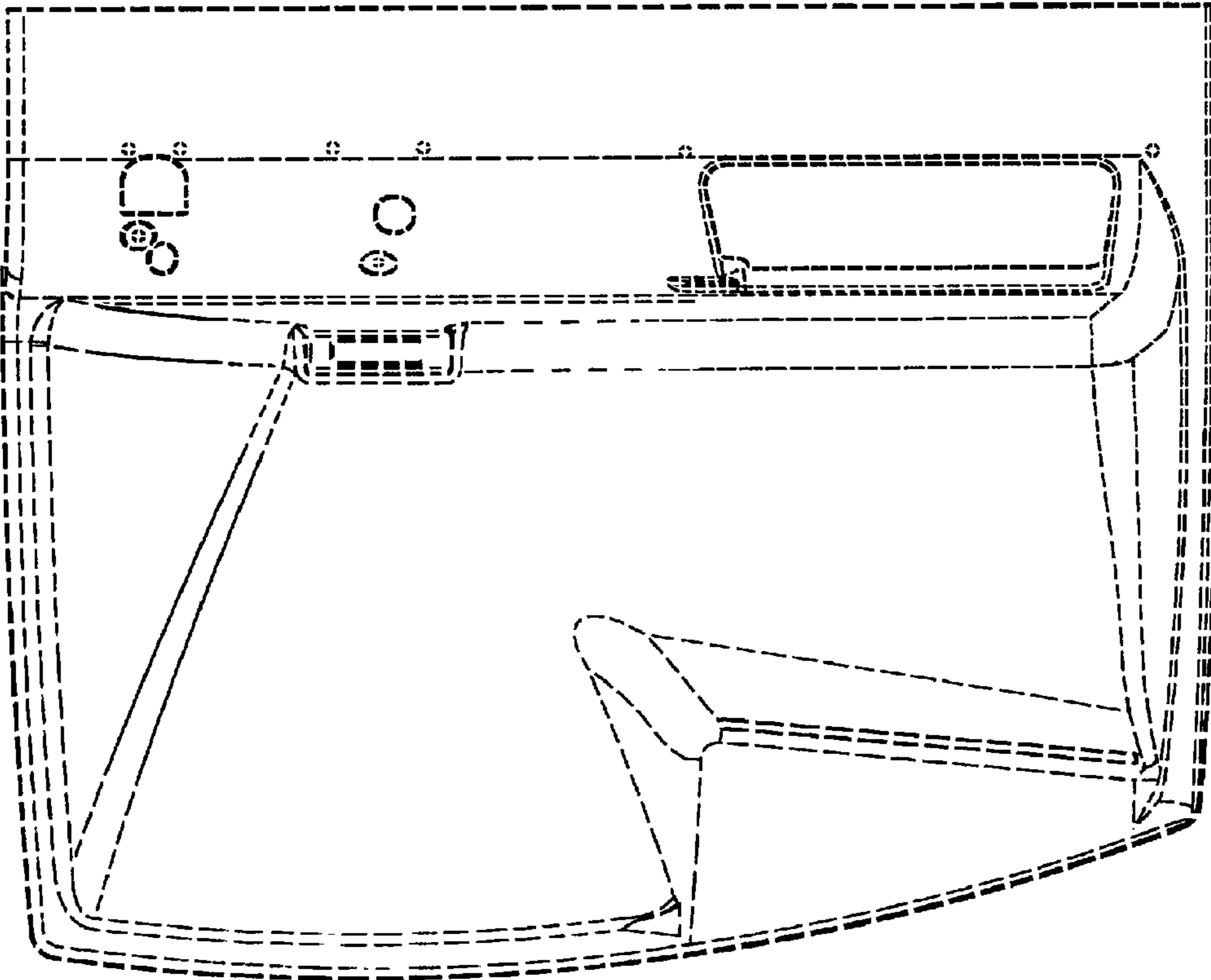

FIG. 3

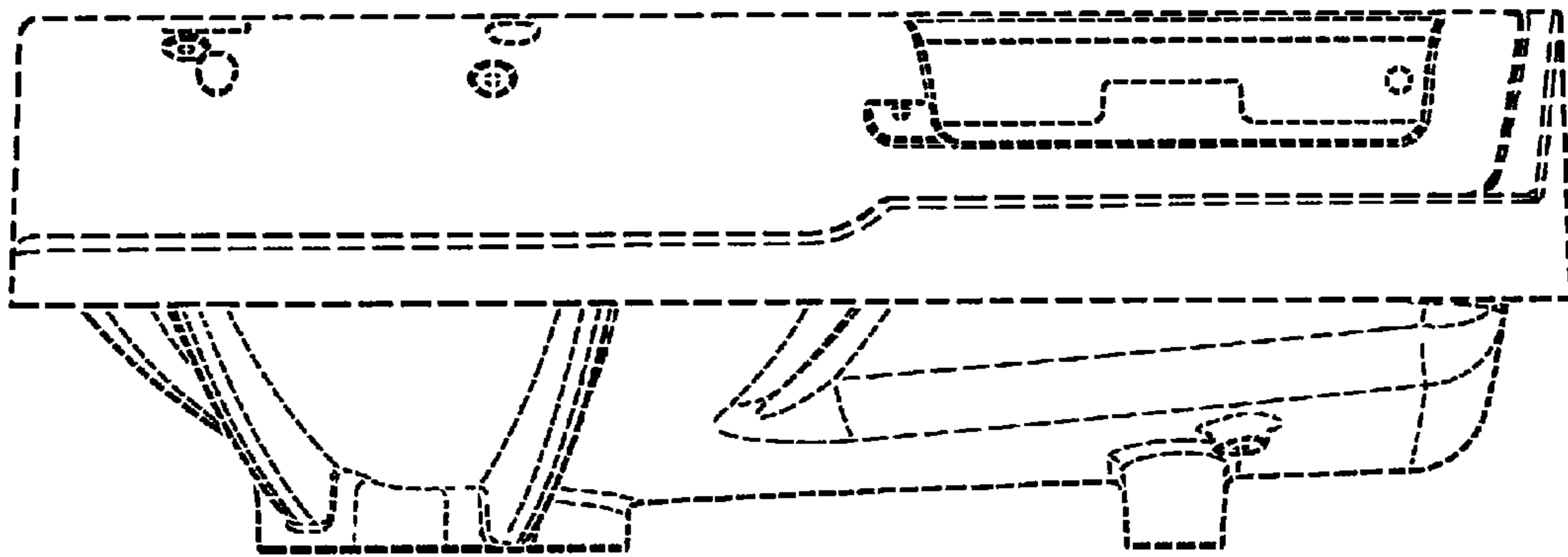

FIG. 4

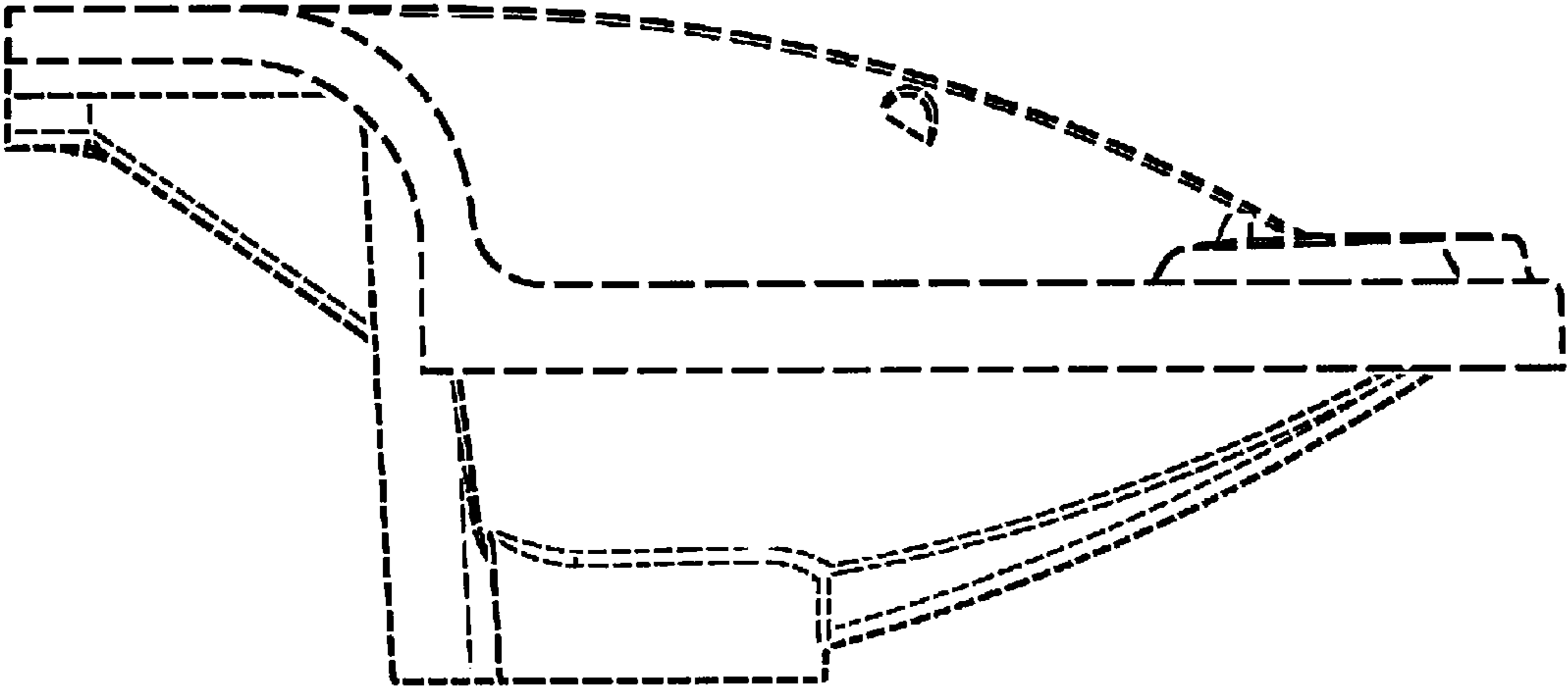

FIG. 5

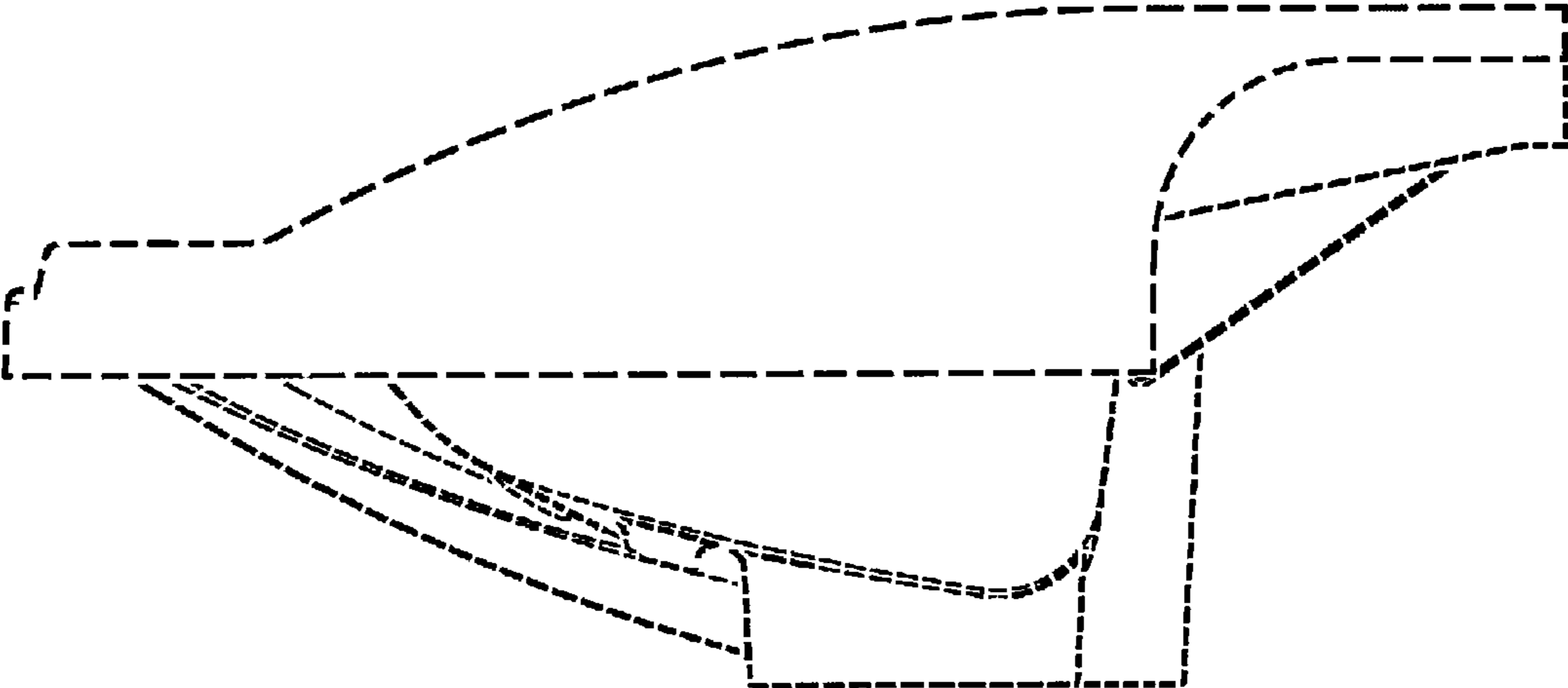

FIG. 6

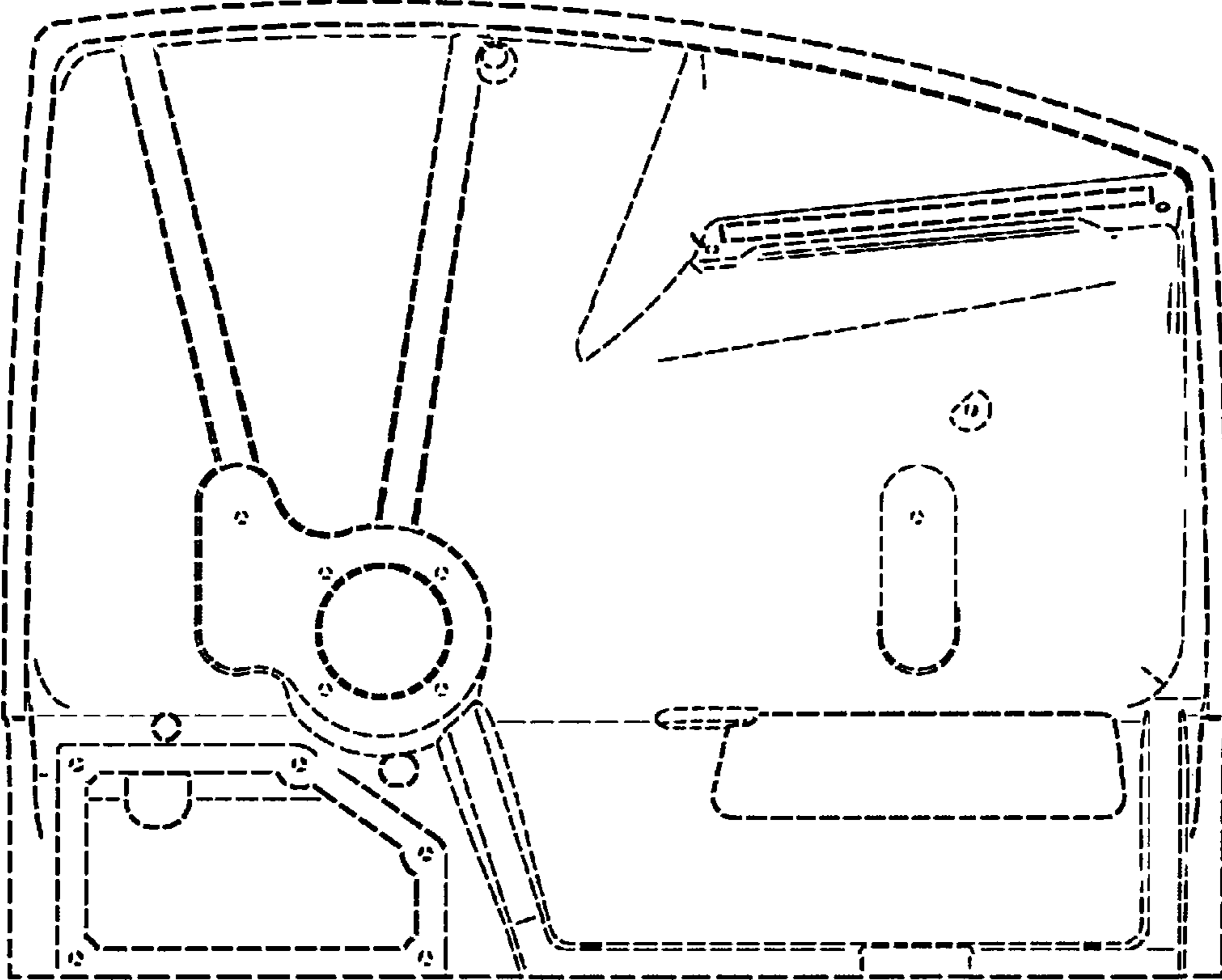

FIG. 7