



US00D680095S

(12) **United States Design Patent**
Tomono

(10) **Patent No.:** **US D680,095 S**
(45) **Date of Patent:** **** Apr. 16, 2013**

(54) **DIGITAL AUDIO DISC PLAYER WITH
TUNER AND AMPLIFIER FOR AUTOMOBILE**

D627,244 S * 11/2010 Nakane et al. D10/65
D630,185 S * 1/2011 Tomono et al. D14/157
D665,380 S * 8/2012 Iwamoto D14/198

(75) Inventor: **Mizuki Tomono**, Kanagawa (JP)

FOREIGN PATENT DOCUMENTS

(73) Assignee: **Pioneer Corporation**, Kawasaki-shi,
Kanagawa (JP),`

JP 1333689 S 6/2008
JP 1367441 S 8/2009
JP 1367443 S 8/2009
JP 1389481 S 6/2010
JP 1389482 S 6/2010
JP 1427714 S 11/2011

(**) Term: **14 Years**

* cited by examiner

(21) Appl. No.: **29/415,960**

(22) Filed: **Mar. 16, 2012**

Primary Examiner — Keli L Hill

(30) **Foreign Application Priority Data**

(74) *Attorney, Agent, or Firm* — Drinker Biddle & Reath
LLP

Oct. 31, 2011 (JP) 2011-025110

(51) **LOC (9) Cl.** **14-03**

(57) **CLAIM**

(52) **U.S. Cl.**

The ornamental design for a digital audio disc player with
tuner and amplifier for automobile, as shown and described.

USPC **D14/168**; D14/132; D14/258

(58) **Field of Classification Search** D14/125,
D14/126, 129, 131, 132, 137, 155, 157, 168-171,
D14/188, 194, 197, 198, 239, 257, 258, 496,
D14/498-508, 511; 455/90.1-90.3, 344-355;
369/6-12

DESCRIPTION

See application file for complete search history.

FIG. 1 is a perspective view of the front, top and right side of
digital audio disc player with tuner and amplifier for automo-
bile showing my new design;

FIG. 2 is a perspective view in a state that a display portion is
slid thereof;

FIG. 3 is a perspective view in a state that the display portion
is detached thereof;

FIG. 4 is a front view thereof;

FIG. 5 is a rear view thereof;

FIG. 6 is a left side view thereof;

FIG. 7 is a right side view thereof;

FIG. 8 is a top view thereof; and,

FIG. 9 is a bottom view thereof.

The broken lines shown are included for the purpose of illus-
trating the unclaimed portions of the article and form no part
of the claim.

(56) **References Cited**

U.S. PATENT DOCUMENTS

D541,681 S * 5/2007 Sekino et al. D10/65
D565,559 S * 4/2008 Aihara D14/258
D565,979 S * 4/2008 Ichikawa et al. D10/65
D574,796 S * 8/2008 Yokoyama D14/132
D579,448 S * 10/2008 Miyazato D14/258
D582,807 S * 12/2008 Ichikawa et al. D10/65
D593,133 S * 5/2009 Yamamoto D14/505
D597,424 S * 8/2009 Miyawaki D10/65
D608,774 S * 1/2010 Iwamoto et al. D14/258
D620,918 S * 8/2010 Tomono D14/168
D622,734 S * 8/2010 Miyawaki D14/502

1 Claim, 9 Drawing Sheets

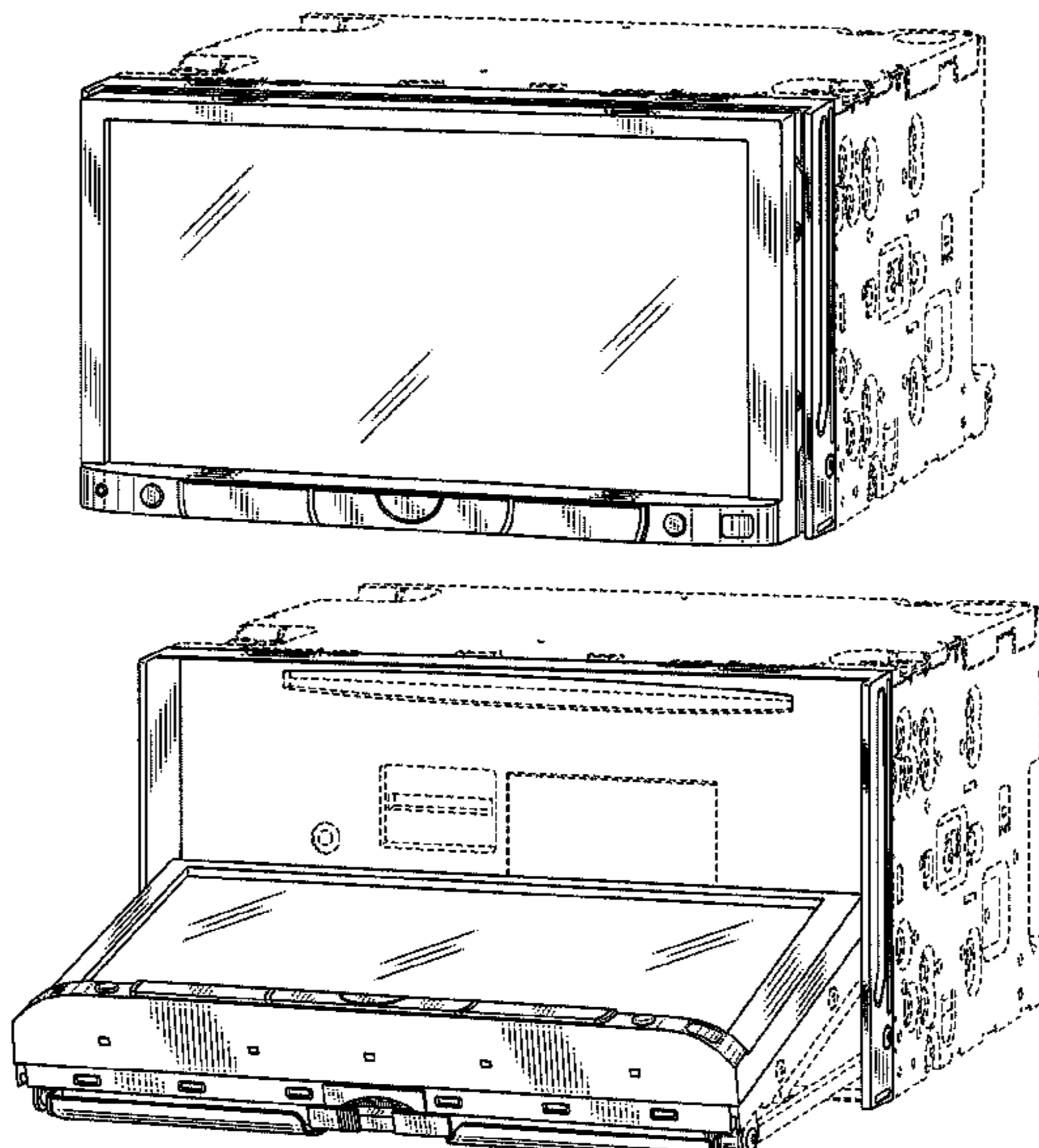

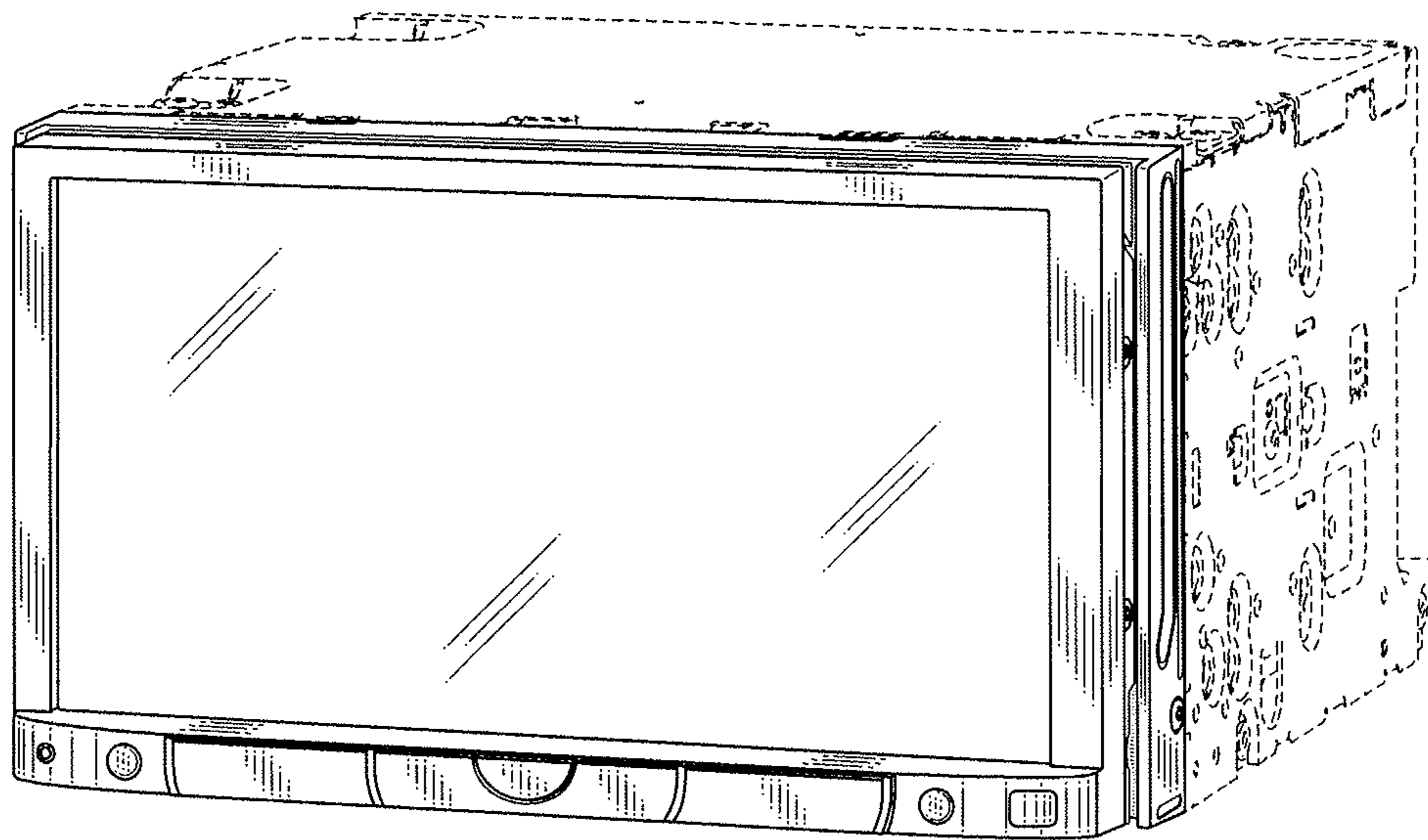

FIG. 1

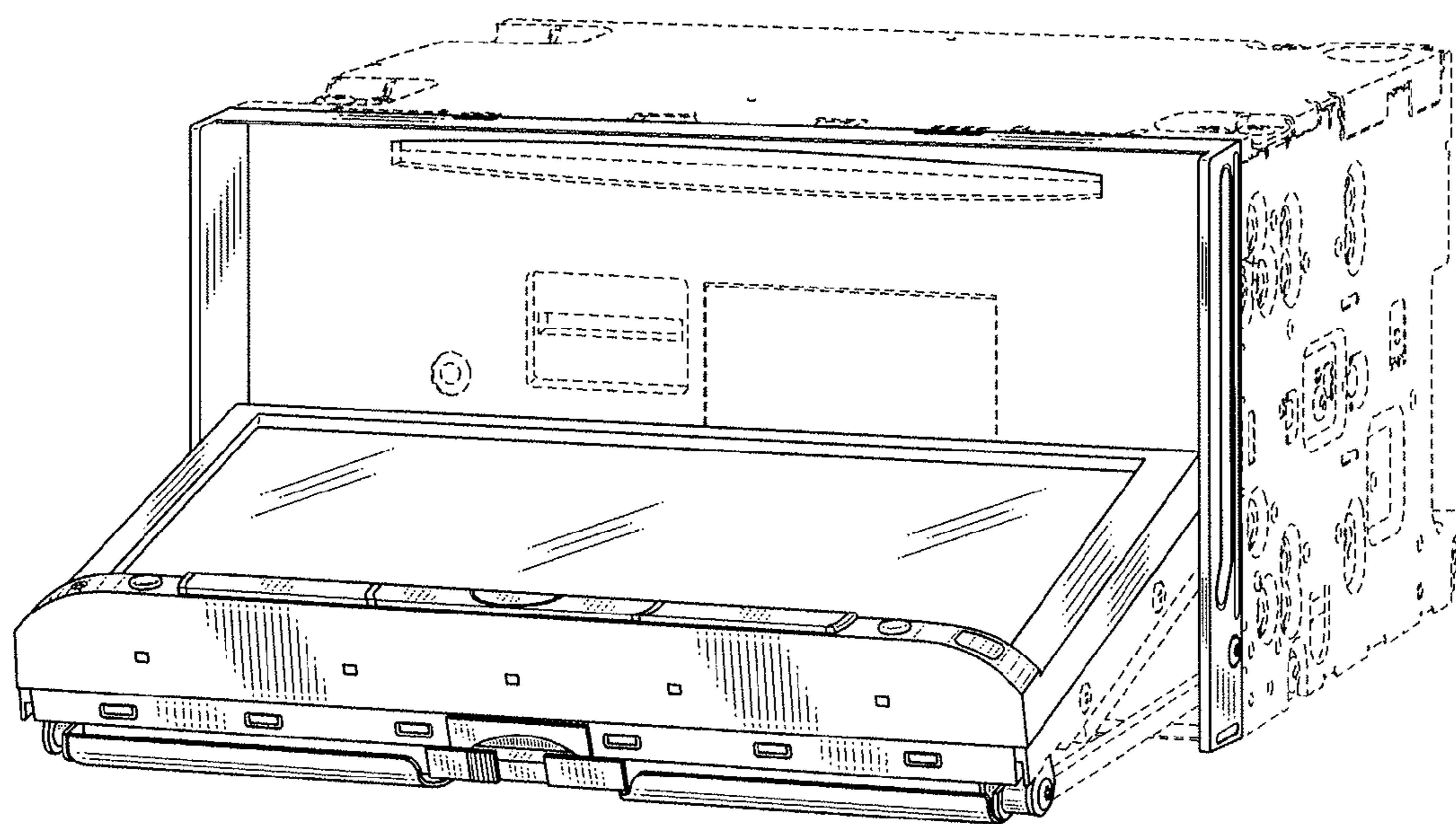

FIG. 2

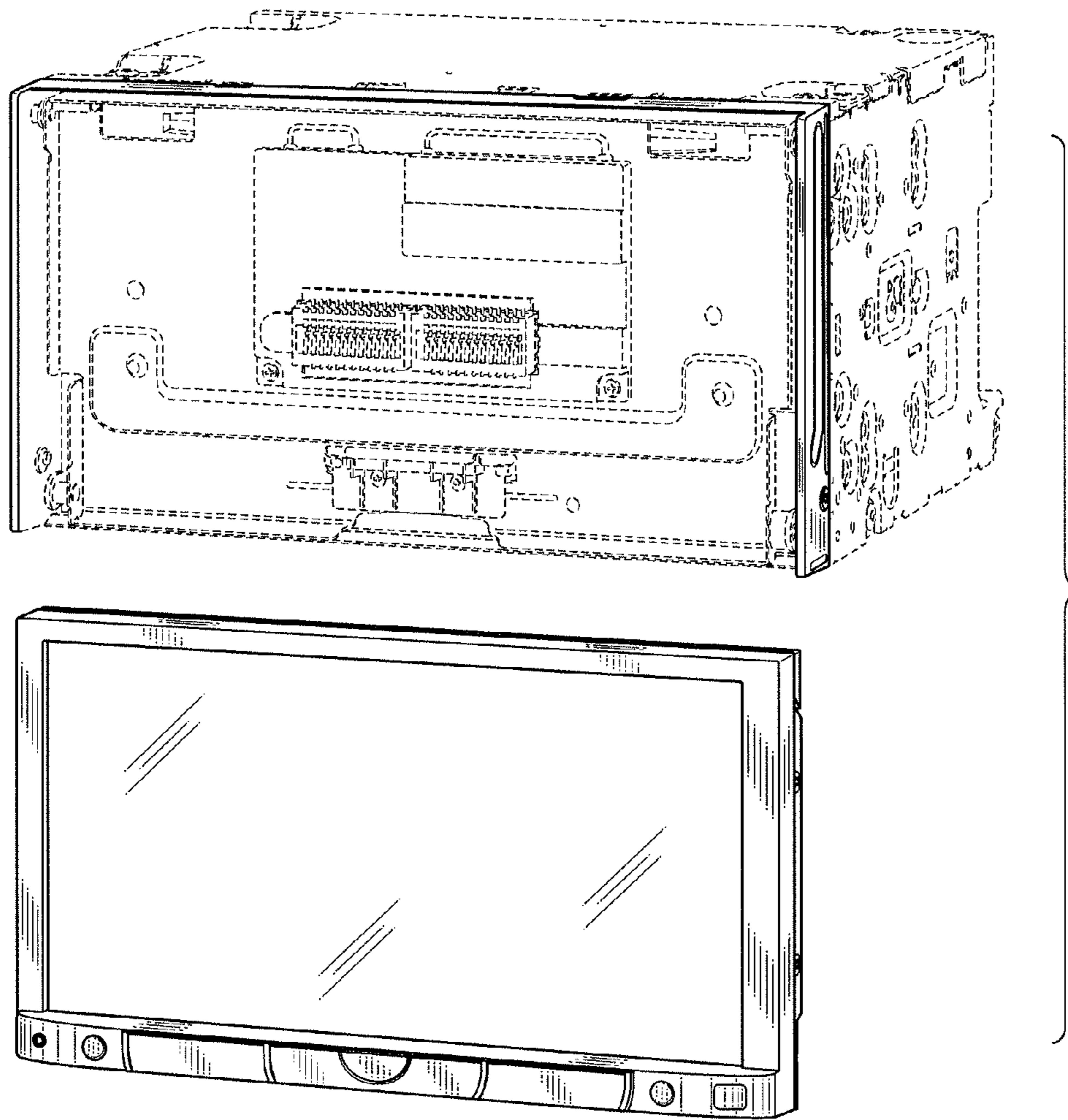

FIG. 3

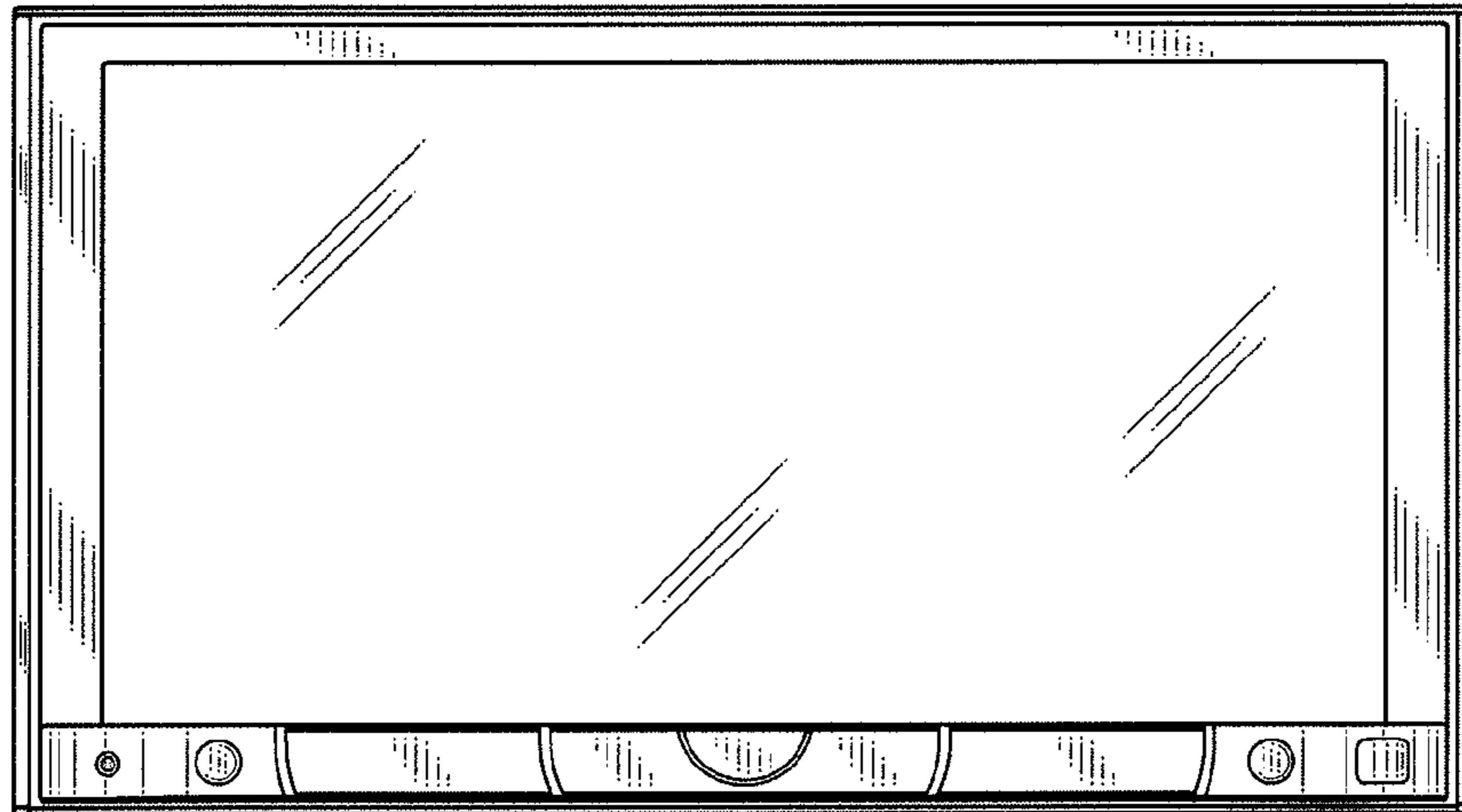

FIG. 4

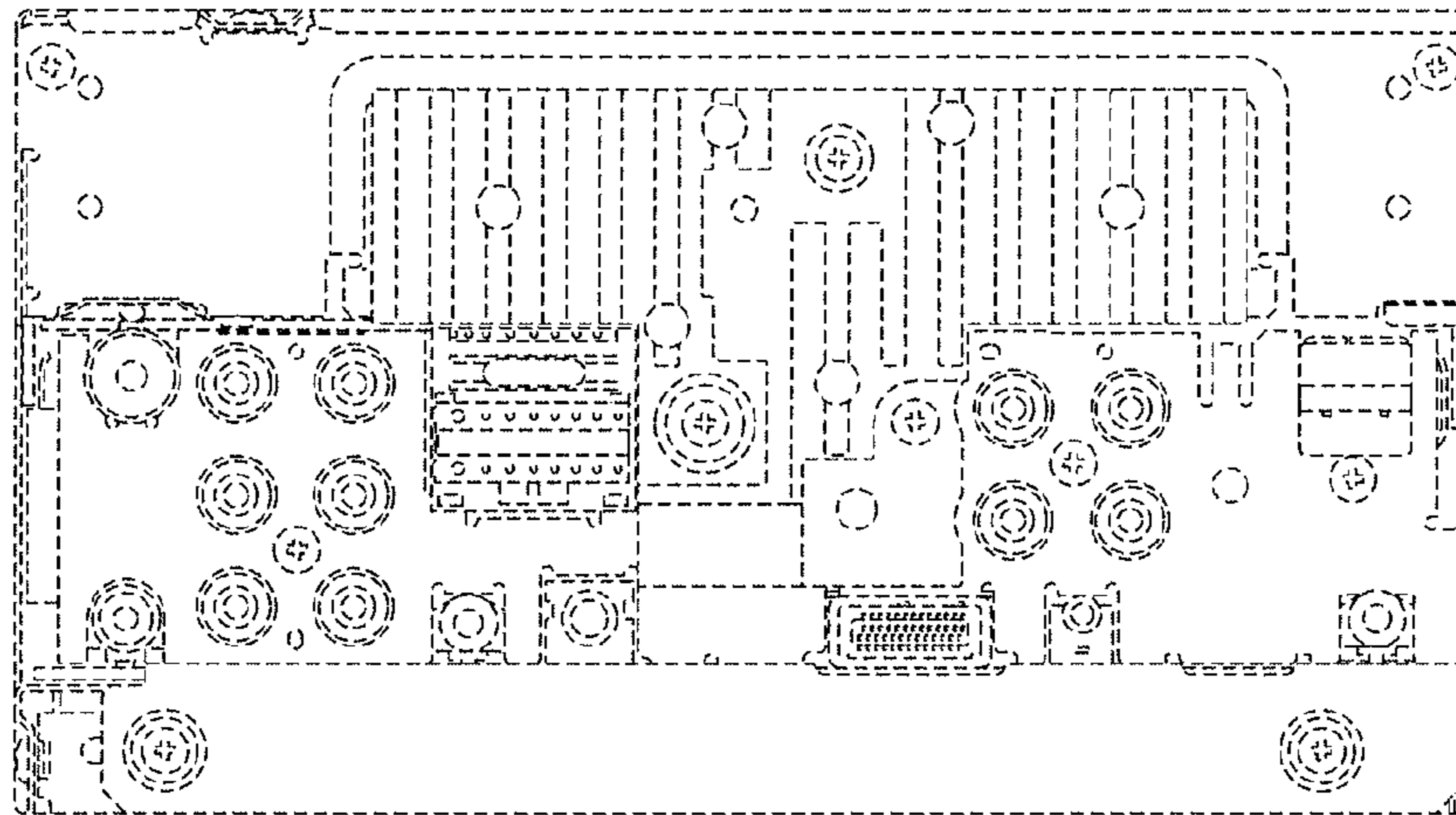

FIG. 5

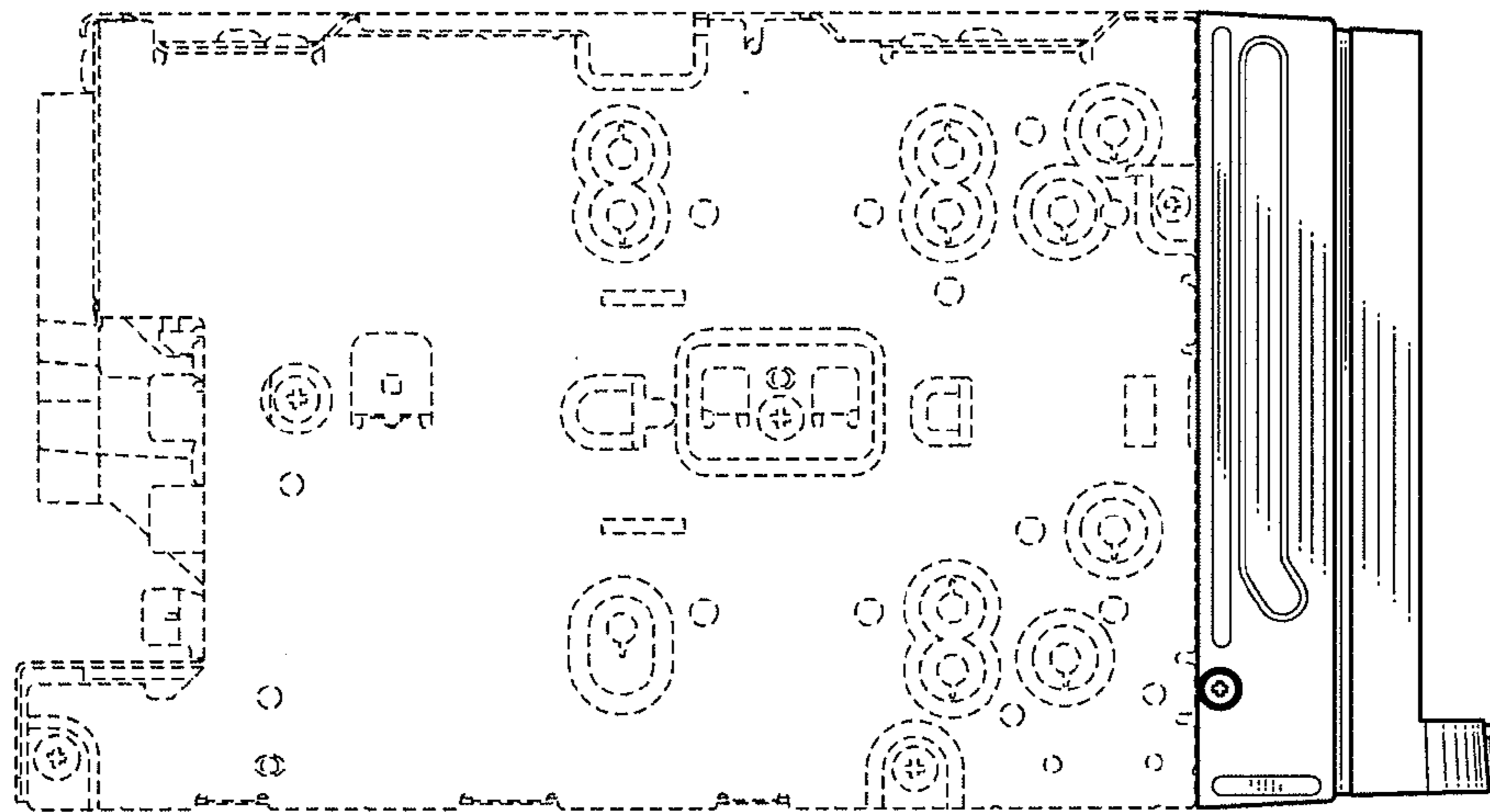

FIG. 6

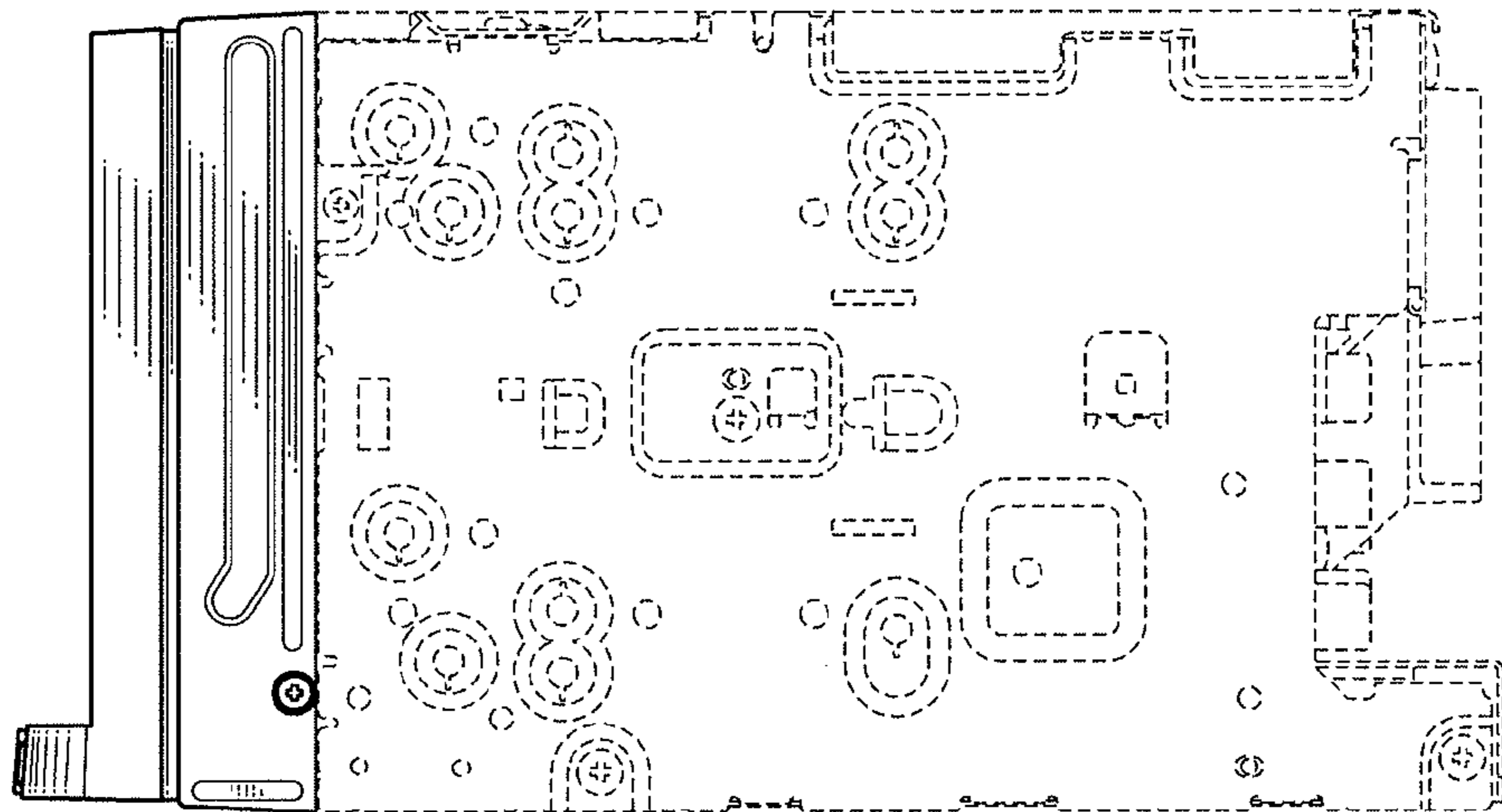

FIG. 7

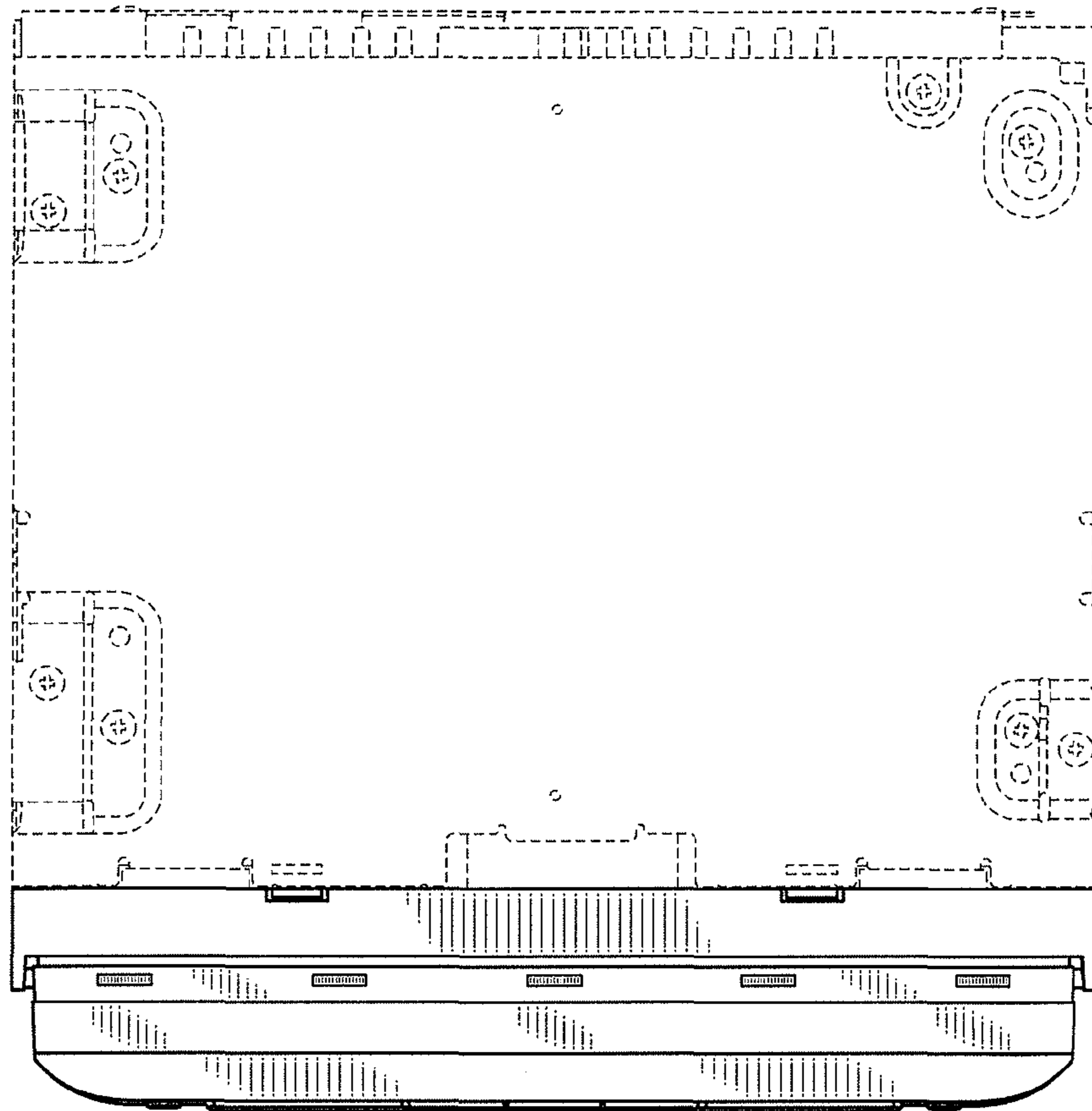

FIG. 8

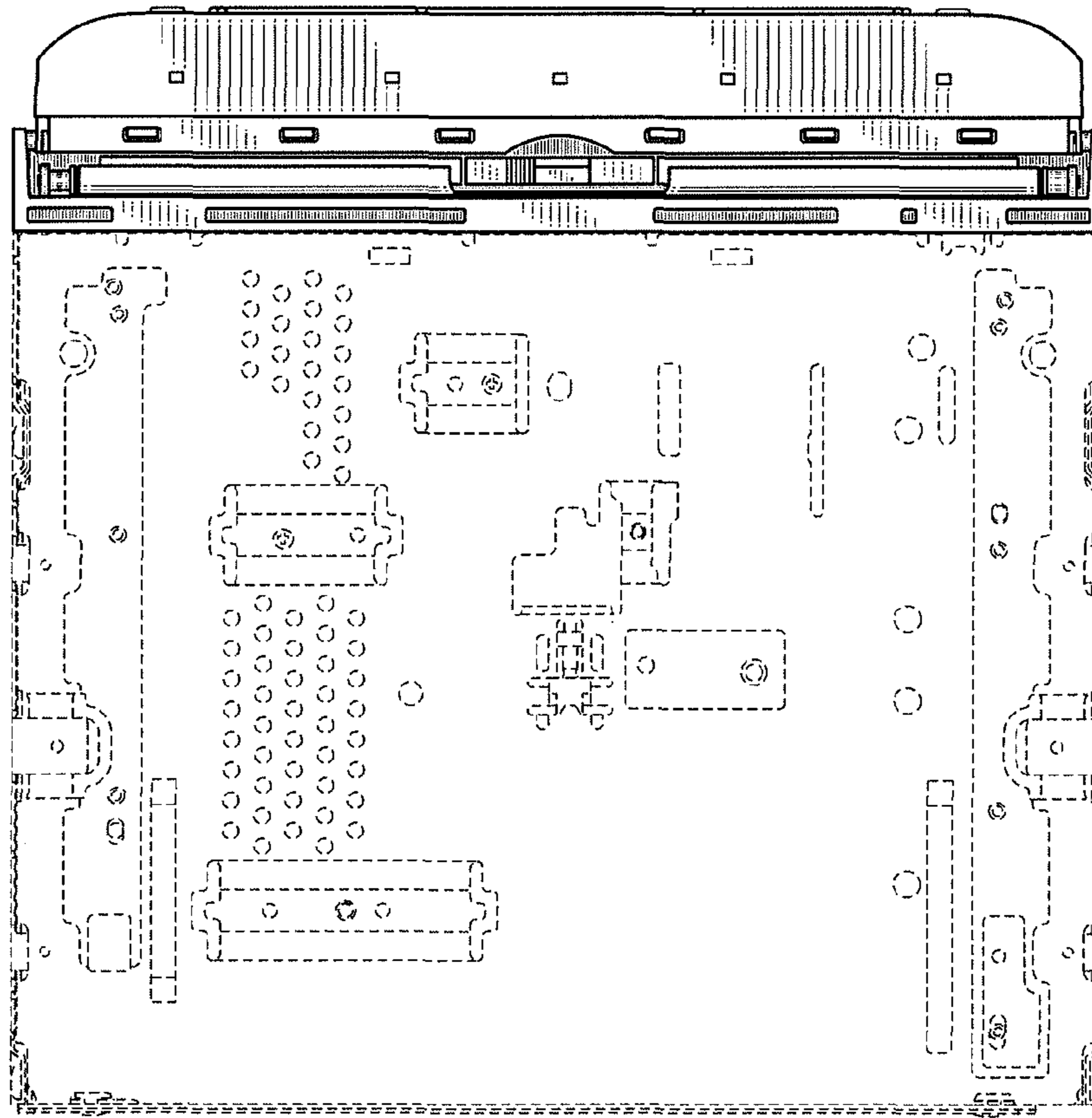

FIG. 9