



US00D680093S

(12) **United States Design Patent**
Sauvage

(10) **Patent No.:** **US D680,093 S**

(45) **Date of Patent:** **** Apr. 16, 2013**

(54) **TELEPHONE**

(75) Inventor: **Sebastien Sauvage**, Sheung Wan (HK)

(73) Assignee: **Binatone Telecom PLC**, London (GB)

(**) Term: **14 Years**

(21) Appl. No.: **29/411,171**

(22) Filed: **Jan. 18, 2012**

(30) **Foreign Application Priority Data**

Jul. 20, 2011 (EP) 11893744-0001

(51) **LOC (9) Cl.** **14-03**

(52) **U.S. Cl.**
USPC **D14/142**

(58) **Field of Classification Search** D14/147,
D14/148, 149, 138 R, 138 AA, 138 AD, 138 G,
D14/191, 203.1-203.8, 496, 137, 218, 341-347,
D14/247-248, 144, 150-151, 240, 243, 140-142;
455/566, 575.1, 575.3, 575.4; 345/168, 169,
345/167

See application file for complete search history.

(56) **References Cited**

U.S. PATENT DOCUMENTS

D248,234 S * 6/1978 Genaro et al. D14/149
D282,542 S * 2/1986 Mo D14/148
D284,572 S * 7/1986 Perkins D14/150
D284,857 S * 7/1986 Brignole D14/150
D356,085 S * 3/1995 Fellingner D14/148
D388,086 S * 12/1997 Constantine et al. D14/150
D426,821 S * 6/2000 Solomita et al. D14/150

* cited by examiner

Primary Examiner — Sheryl Lane

(74) *Attorney, Agent, or Firm* — Wolf, Greenfield & Sacks P.C.

(57) **CLAIM**

The ornamental design for telephone, as shown and described.

DESCRIPTION

FIG. 1 is a right side view of a telephone;
FIG. 2 is a right side view of the telephone with the handset separated from the base;
FIG. 3 is a front view thereof;
FIG. 4 is a back side view thereof;
FIG. 5 is a perspective view of the telephone with the handset and the base together;
FIG. 6 is a perspective view of the telephone with the handset and the base separated;
FIG. 7 is a perspective view of the telephone with the handset and the base together;
FIG. 8 is a perspective view of the telephone with the handset and the base together;
FIG. 9 is a perspective view of the handset thereof;
FIG. 10 is a perspective view of the base thereof;
FIG. 11 is a perspective view of the telephone with the handset and the base separated;
FIG. 12 is a perspective view of the handset thereof;
FIG. 13 is a front view of the handset thereof;
FIG. 14 is a right view of the handset thereof; and,
FIG. 15 is a back view of the handset thereof.

1 Claim, 12 Drawing Sheets

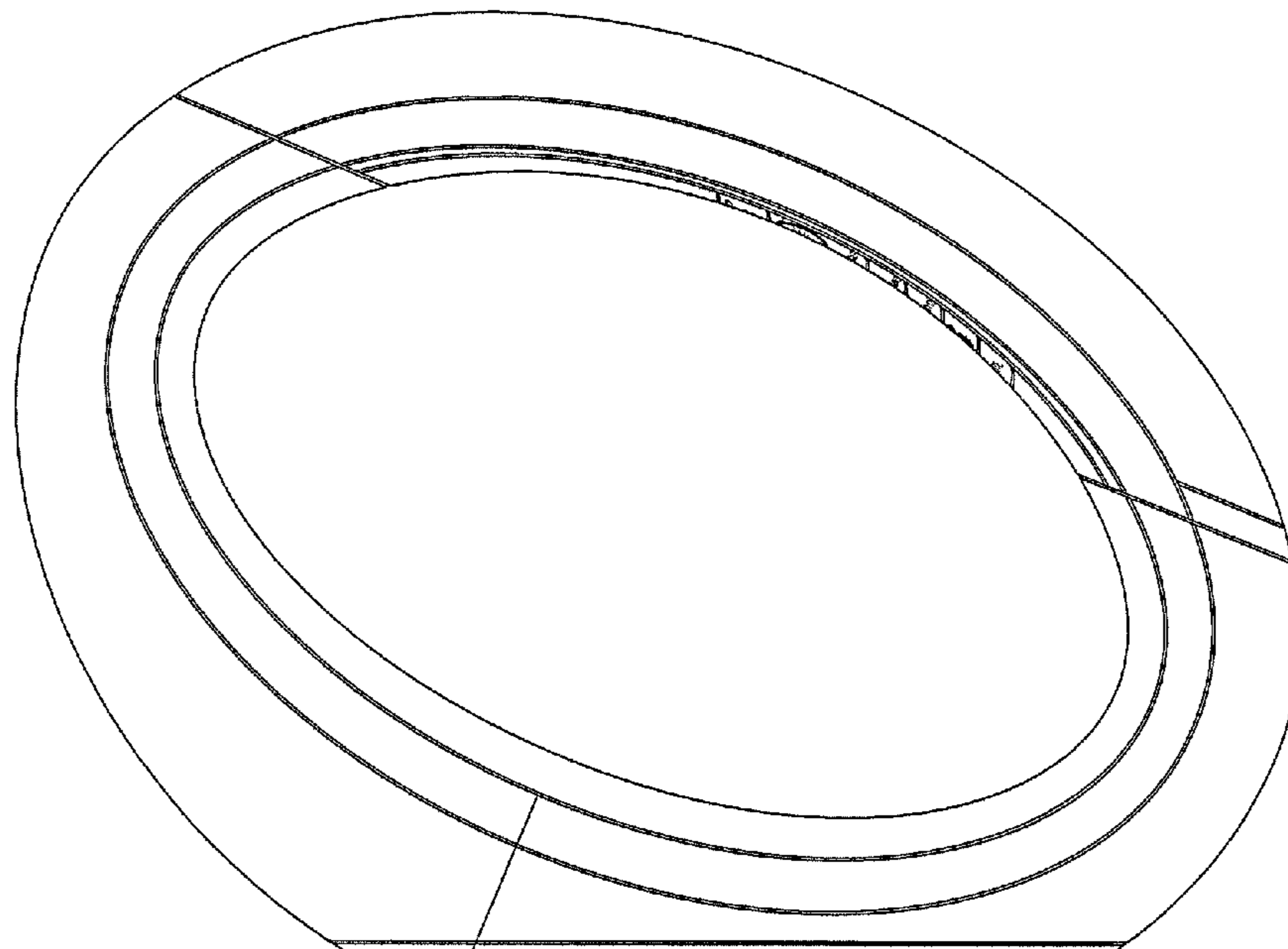

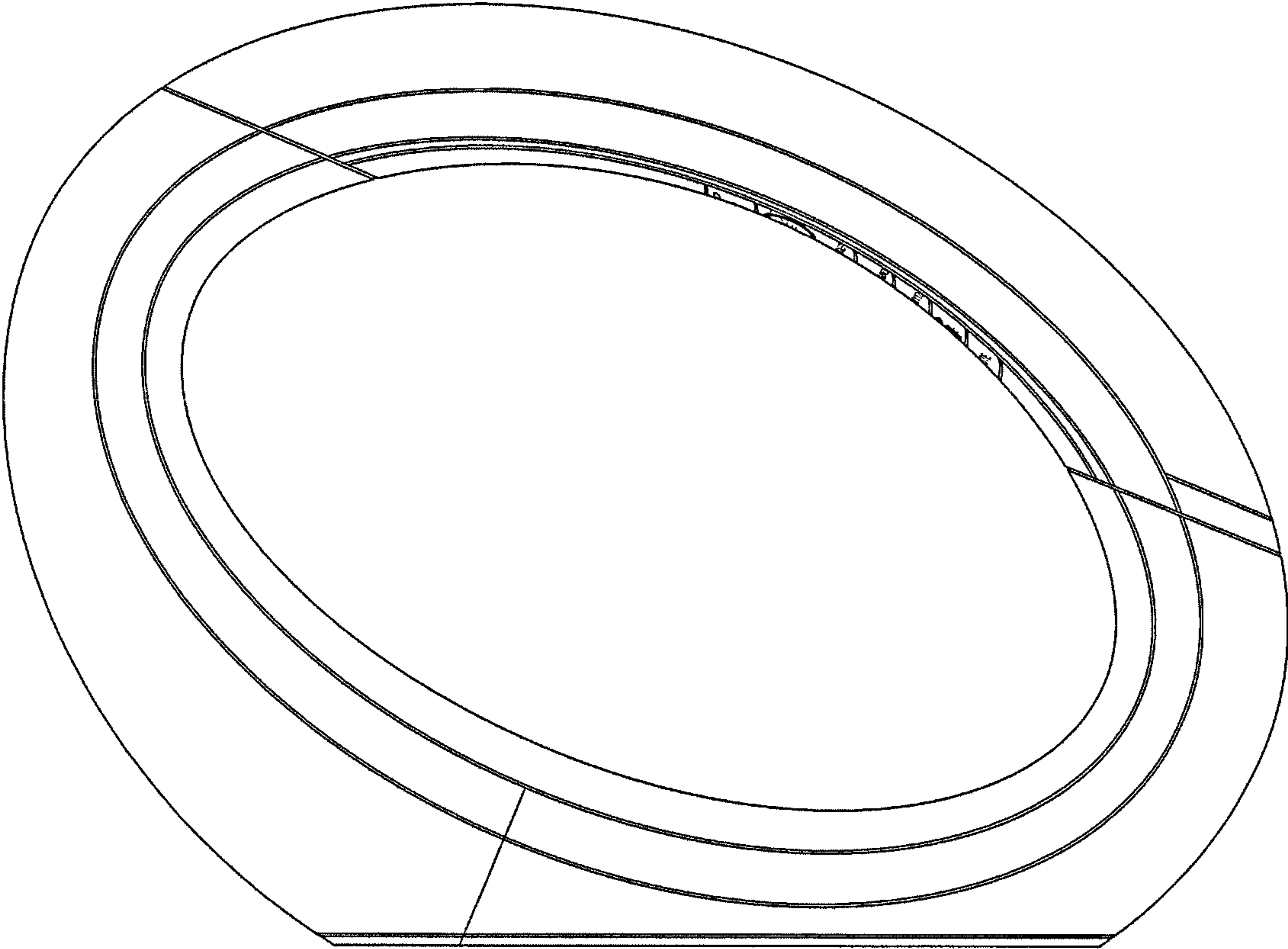

FIG. 1

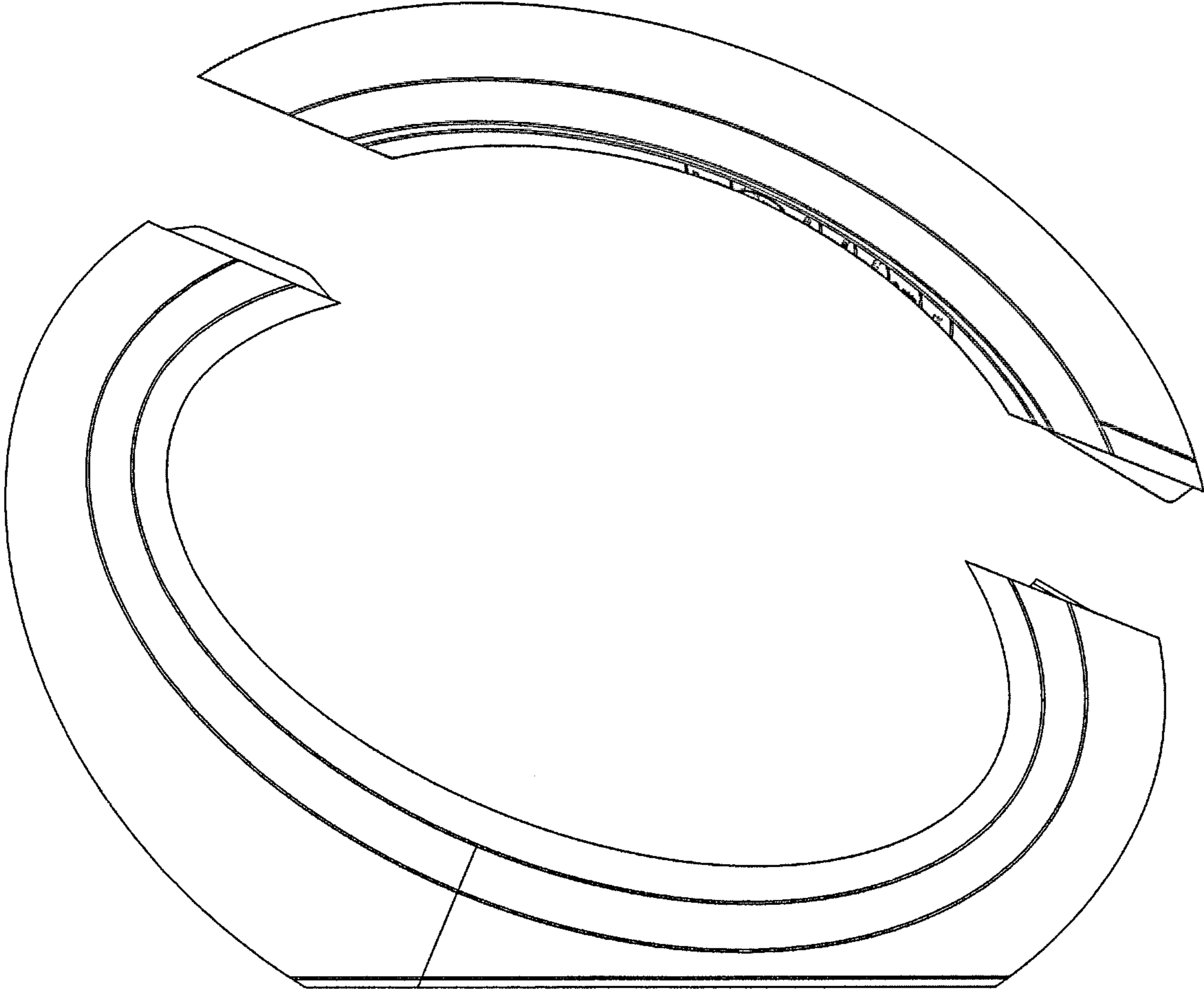

FIG. 2

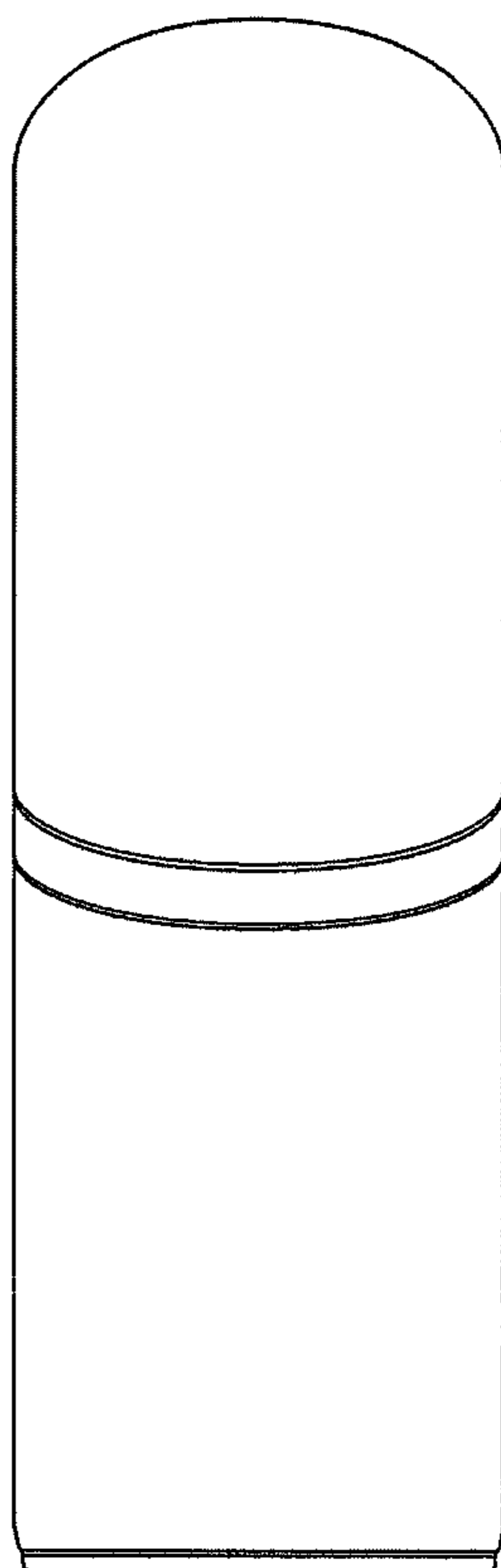

FIG. 3

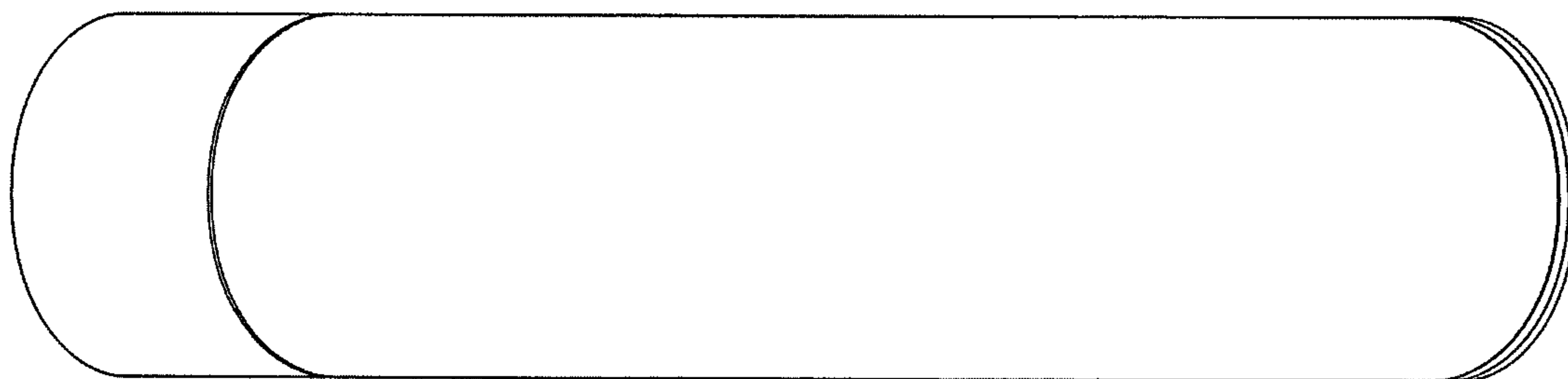

FIG. 4

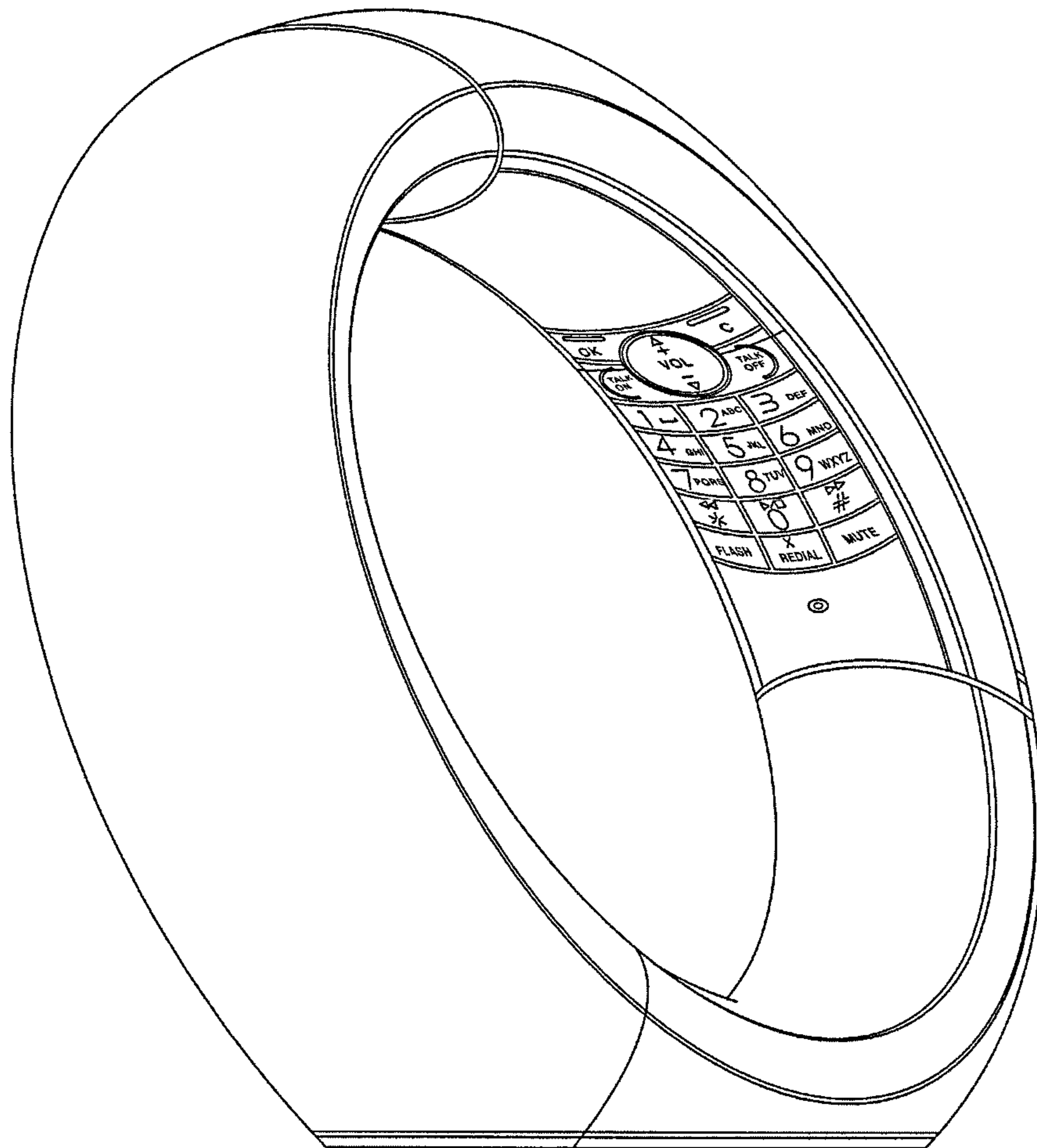

FIG. 5

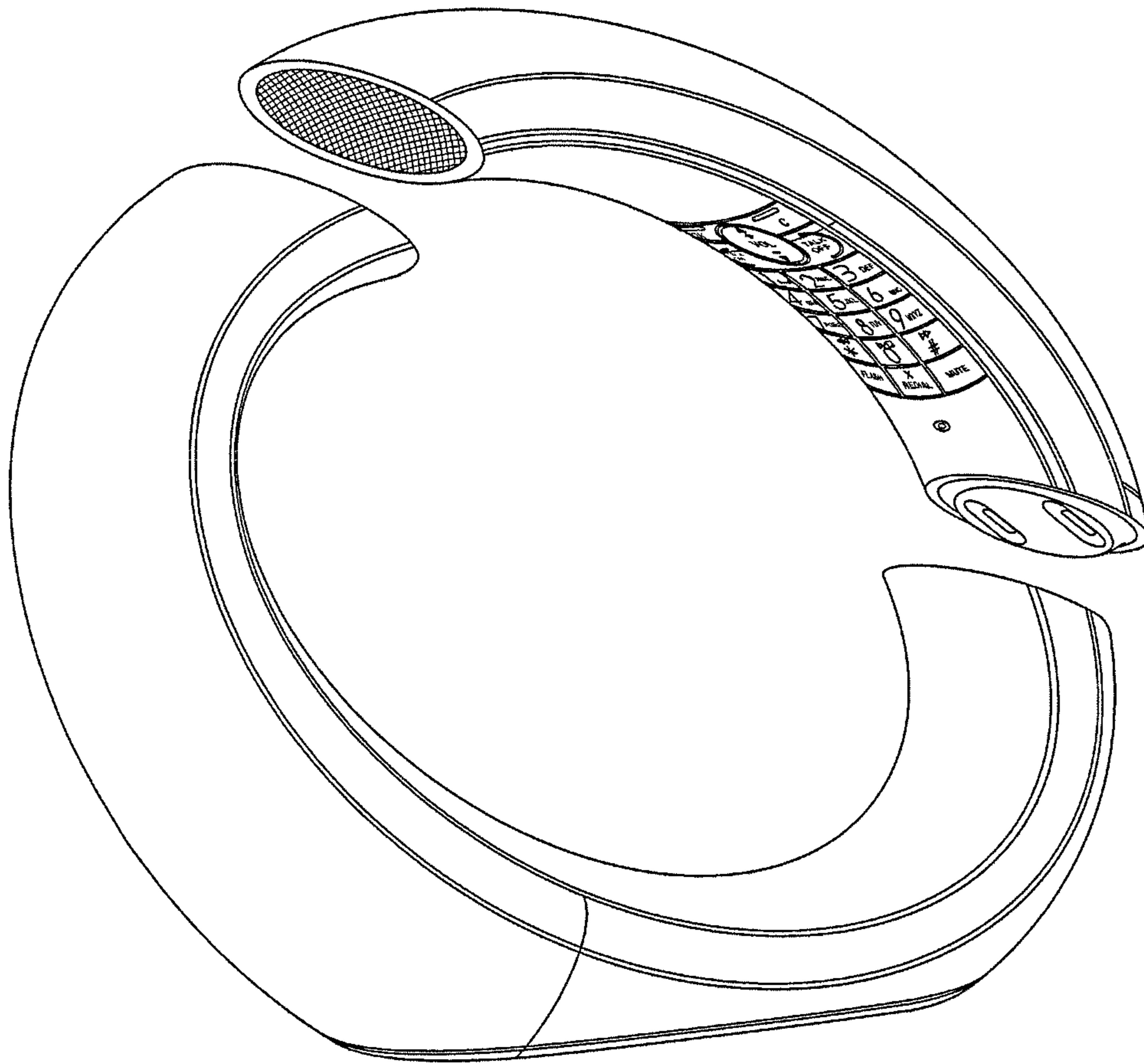

FIG. 6

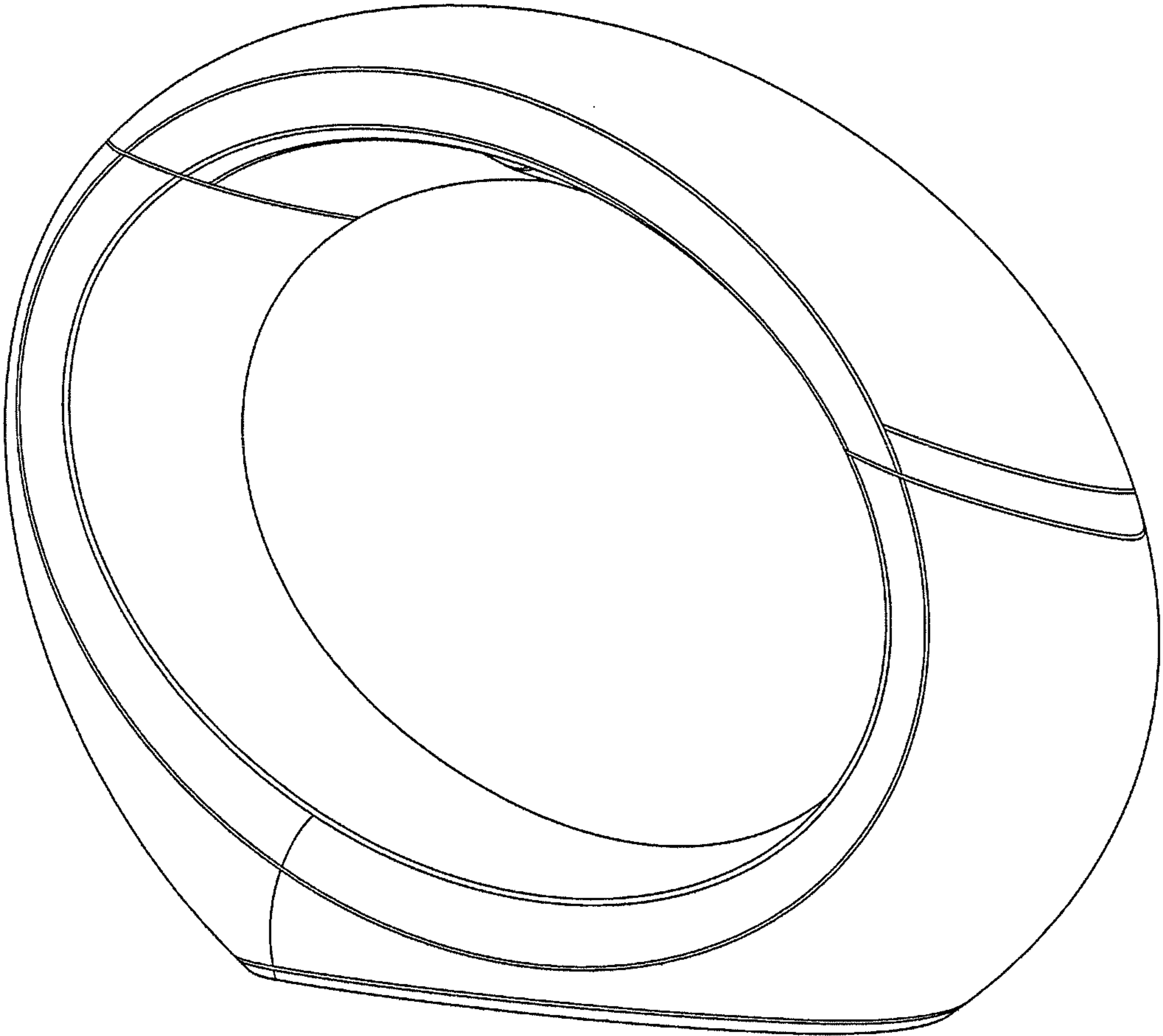

FIG. 7

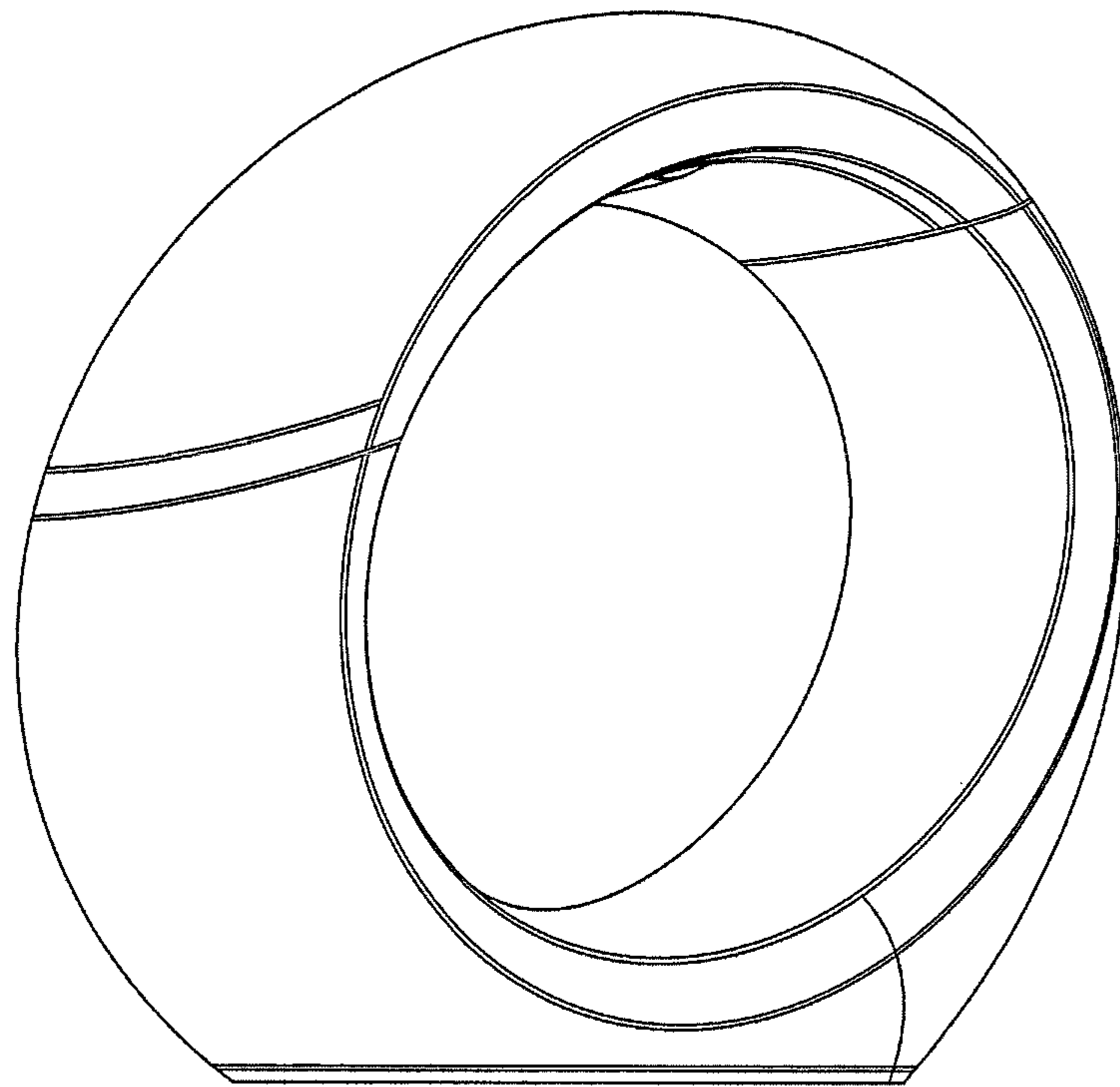

FIG. 8

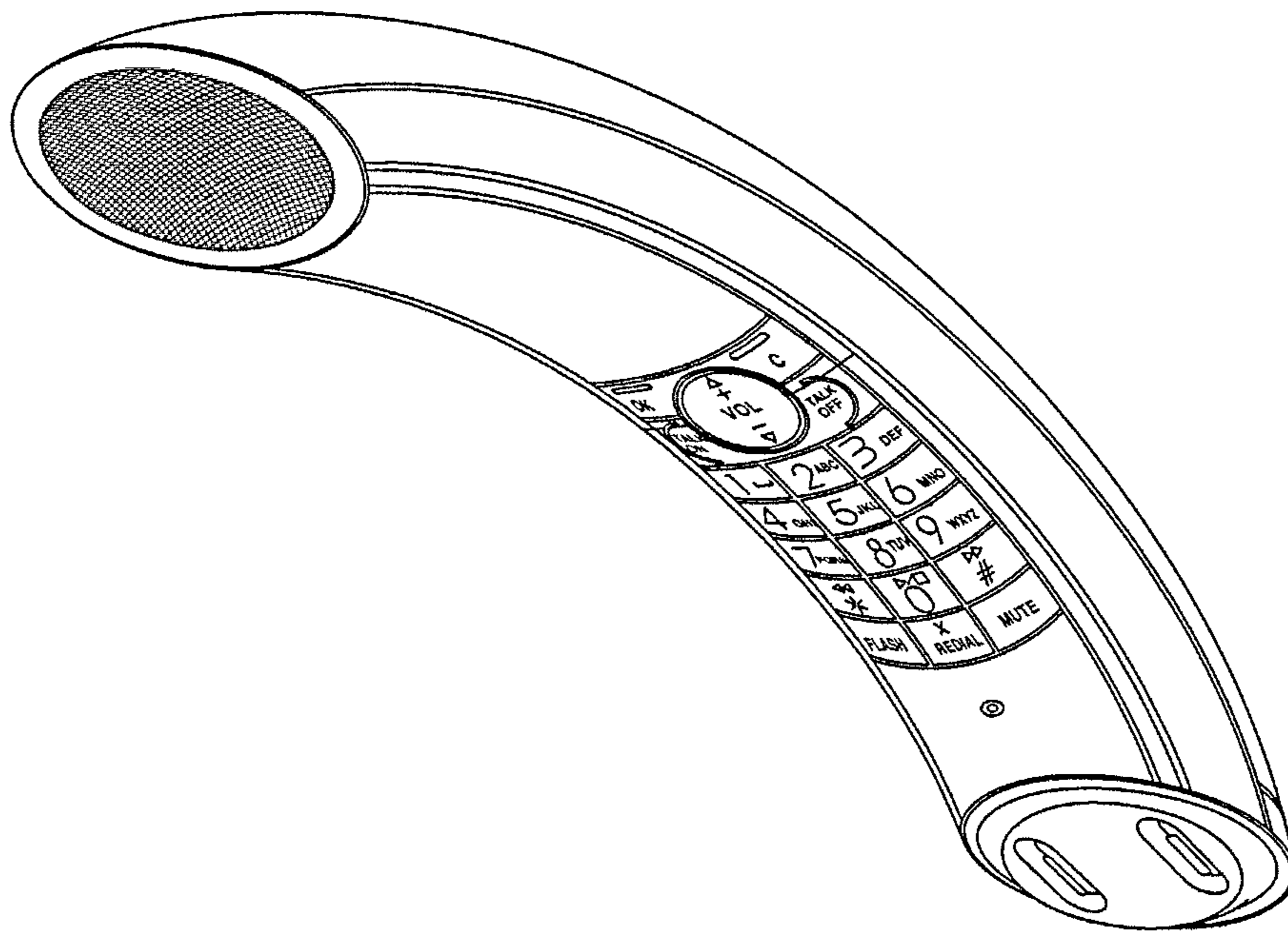

FIG. 9

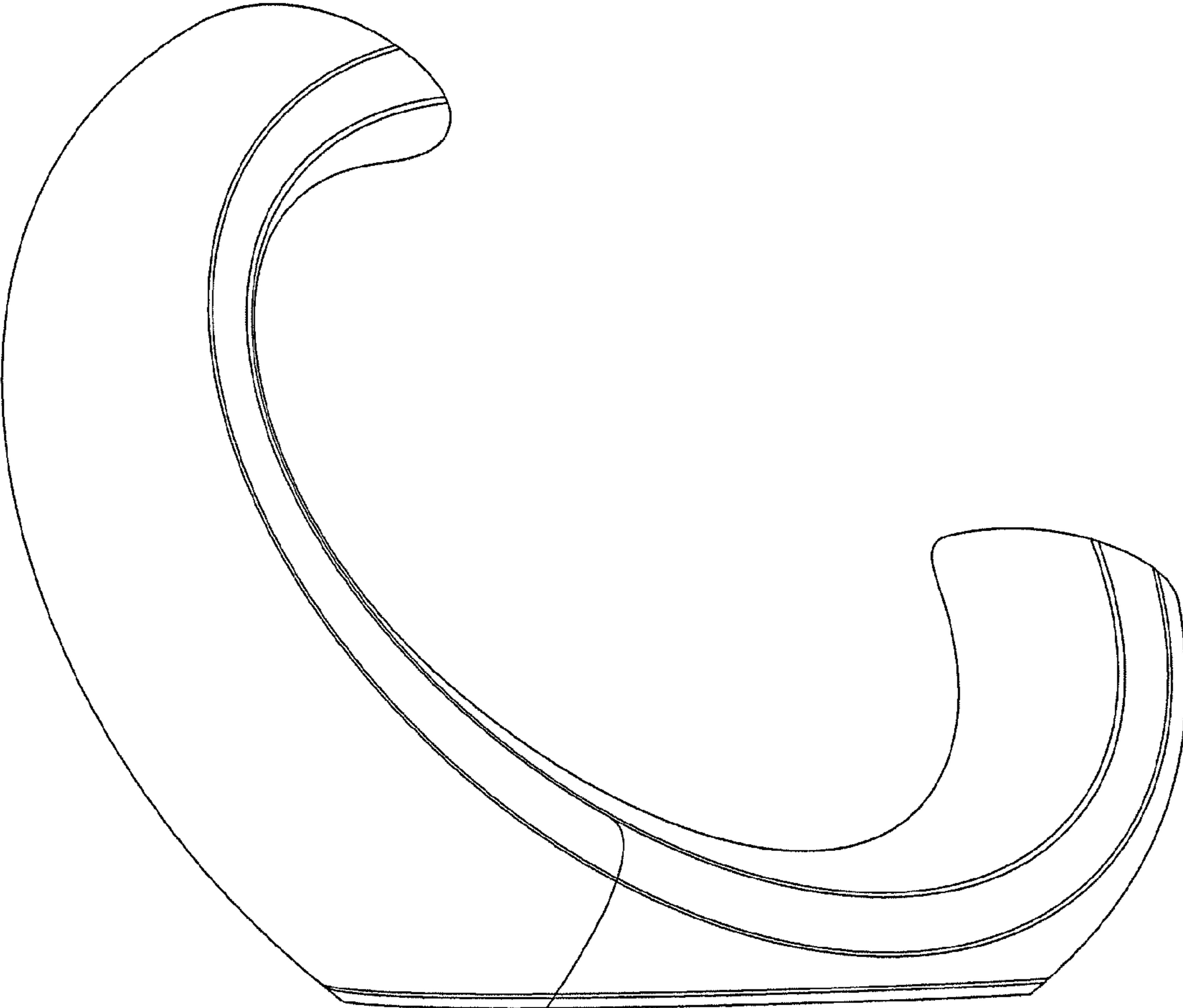

FIG. 10

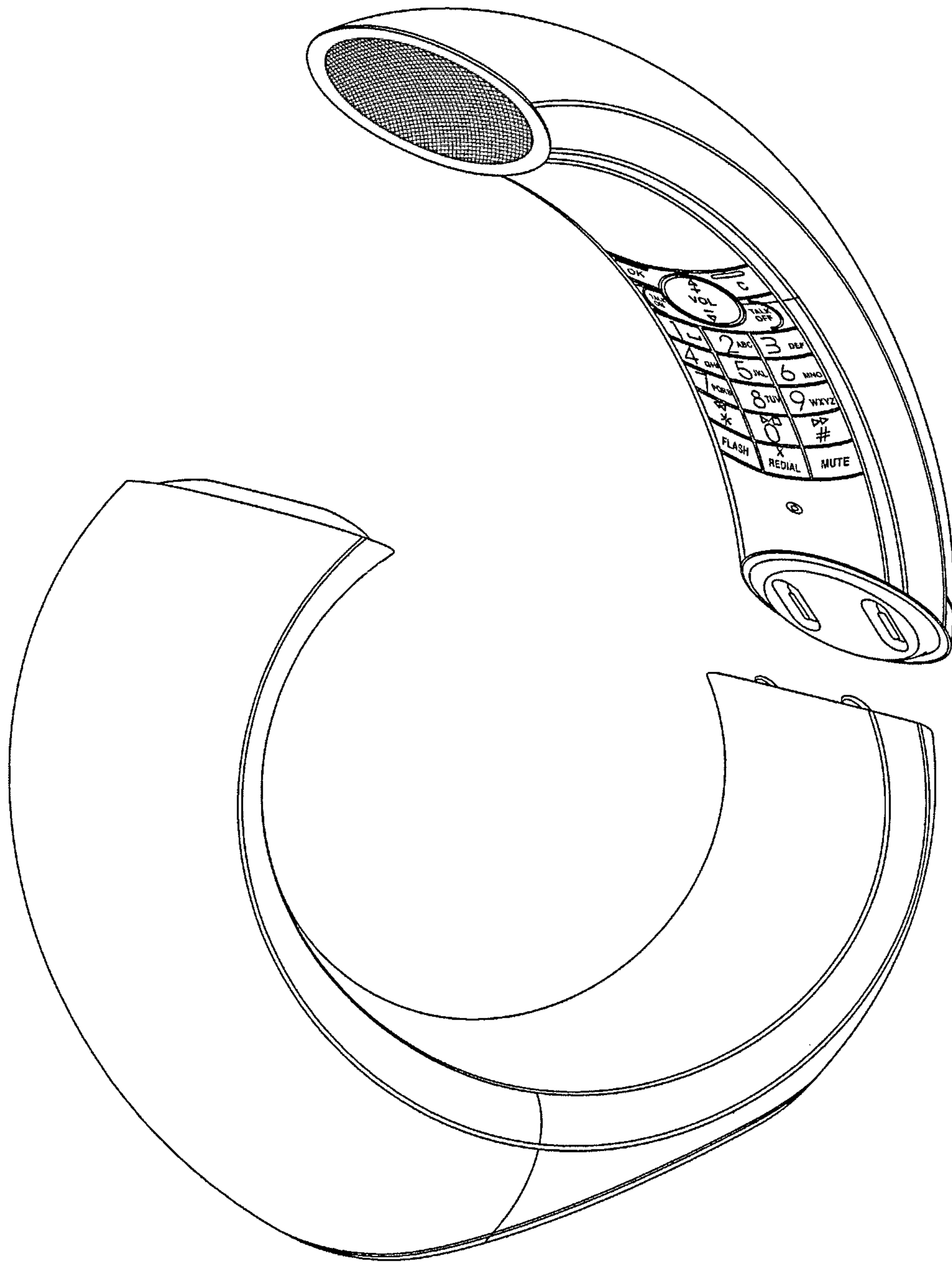

FIG. 11

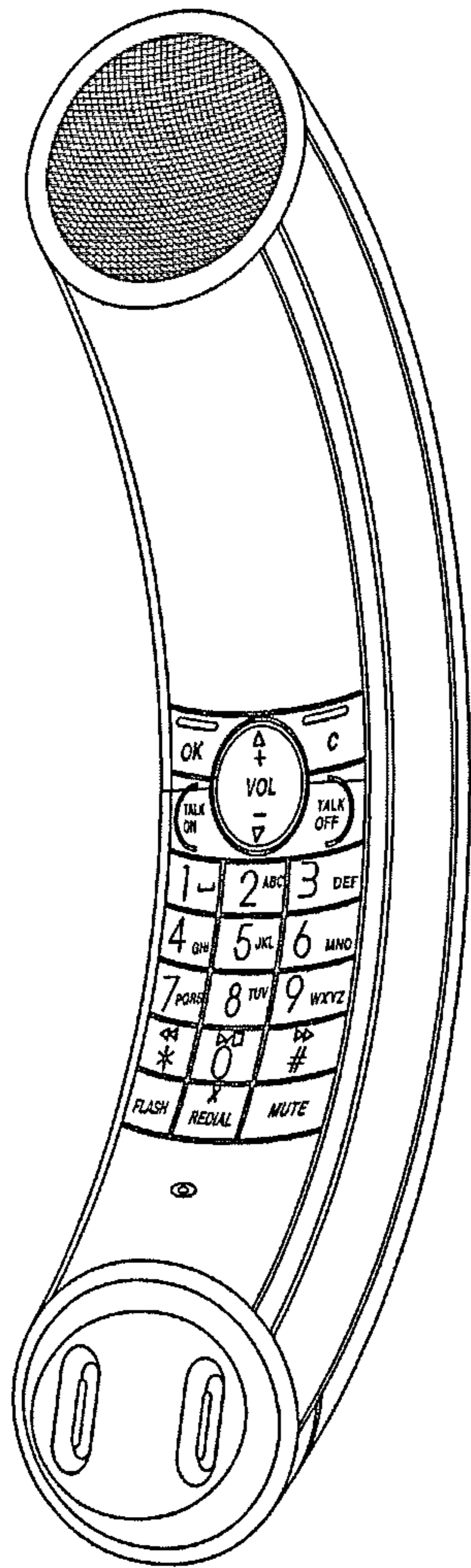

FIG. 12

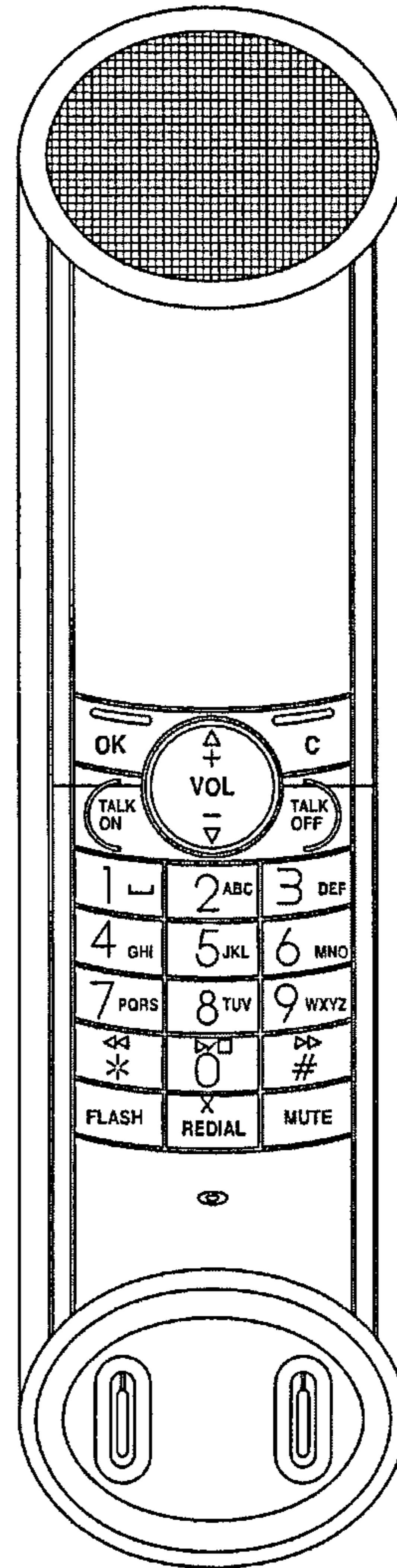

FIG. 13

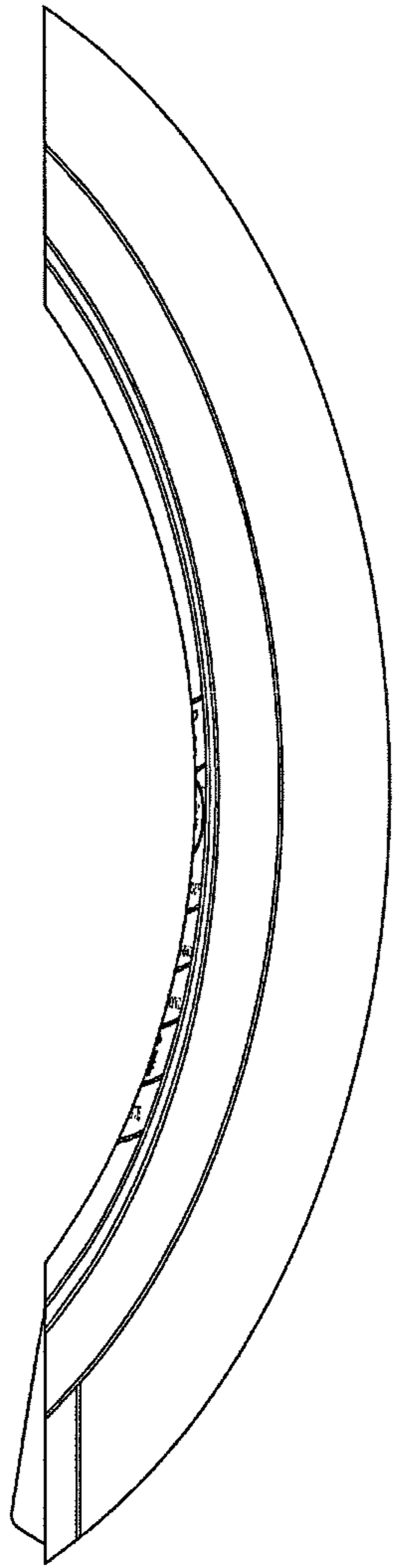

FIG. 14

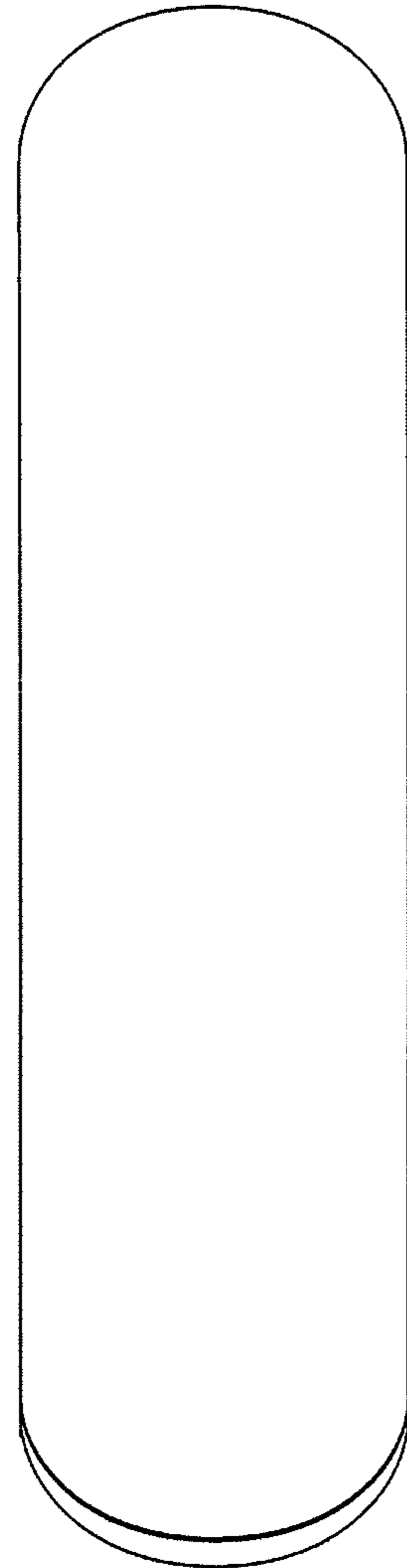

FIG. 15