



US00D679986S

(12) **United States Design Patent**
Hsieh et al.

(10) **Patent No.:** **US D679,986 S**

(45) **Date of Patent:** **** *Apr. 16, 2013**

(54) **DECORATIVE LOCK COVER**

(56) **References Cited**

(75) Inventors: **Lung-Fa Hsieh**, Taichung (TW);
Tong-Yi Ho, Minxiong Township,
Chiayi County (TW); **Chen-Ming Lin**,
Minxiong Township, Chiayi County
(TW); **Suh-You Yang**, Minxiong
Township, Chiayi County (TW);
Shih-Kai Hsu, Chiayi (TW)

(73) Assignee: **Tong Lung Metal Industry Co., Ltd.**,
Chiayi (TW)

(*) Notice: This patent is subject to a terminal dis-
claimer.

(**) Term: **14 Years**

(21) Appl. No.: **29/411,220**

(22) Filed: **Jan. 18, 2012**

(30) **Foreign Application Priority Data**

Aug. 29, 2011 (TW) 100304457

(51) **LOC (9) Cl.** **08-07**

(52) **U.S. Cl.**
USPC **D8/330**

(58) **Field of Classification Search** D8/330,
D8/331, 343, 346, 398, 394, 449; 70/57,
70/57.1, 51-56, 416, 485, 486, 445, 419,
70/431, 422, 158, DIG. 26; 220/280, 265,
220/277

See application file for complete search history.

U.S. PATENT DOCUMENTS

4,578,970	A *	4/1986	Youngblood et al.	70/428
4,905,486	A *	3/1990	Appelbaum	70/54
5,046,339	A *	9/1991	Krell	70/55
5,477,710	A *	12/1995	Stefanutti	70/56
6,439,008	B1 *	8/2002	Keil	70/56
6,578,393	B2 *	6/2003	Yarborough	70/56
D525,112	S *	7/2006	Butts et al.	D8/346
D526,557	S *	8/2006	Falconer et al.	D8/346
D527,614	S *	9/2006	St. James	D8/346
D569,226	S *	5/2008	Brewster et al.	D8/346
7,926,215	B2 *	4/2011	Riker et al.	40/654.01
D667,287	S *	9/2012	Yang	D8/346

* cited by examiner

Primary Examiner — Prabhakar Deshmukh

(74) *Attorney, Agent, or Firm* — Chun-Ming Shih

(57) **CLAIM**

The ornamental design for a decorative lock cover, as shown and described.

DESCRIPTION

FIG. 1 is a perspective view of a decorative lock cover showing my design;

FIG. 2 is a front elevational view thereof;

FIG. 3 is a rear elevational view thereof;

FIG. 4 is a left side elevational view thereof;

FIG. 5 is a right side elevational view thereof;

FIG. 6 is a top plan view thereof; and

FIG. 7 is a bottom plan view thereof;

FIG. 8 is a perspective view thereof, shown in its environmental use; and,

FIG. 9 is a perspective view thereof, shown in another environmental use.

The broken lines environment is for illustrative purpose only and forms no part of the claimed design.

1 Claim, 7 Drawing Sheets

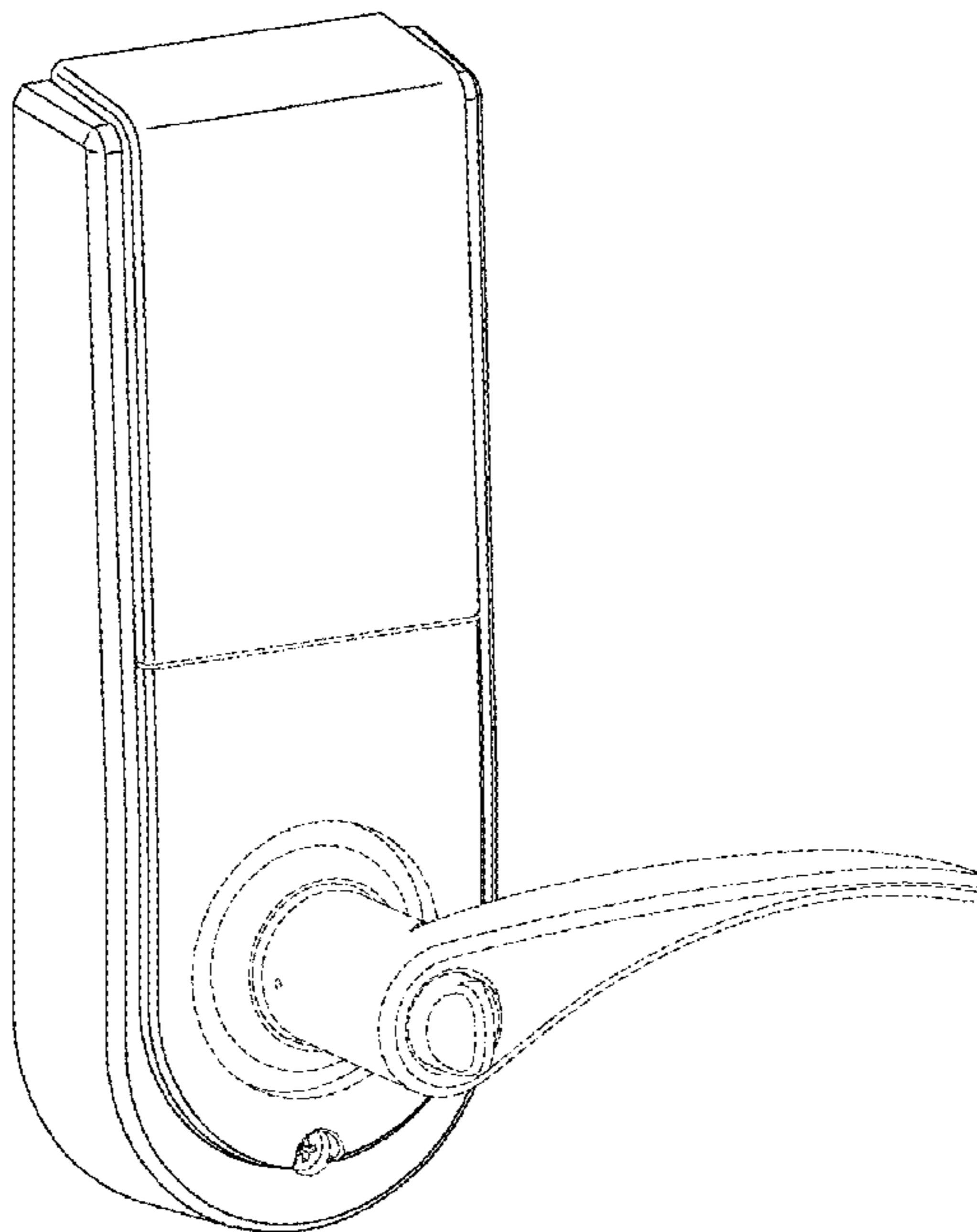

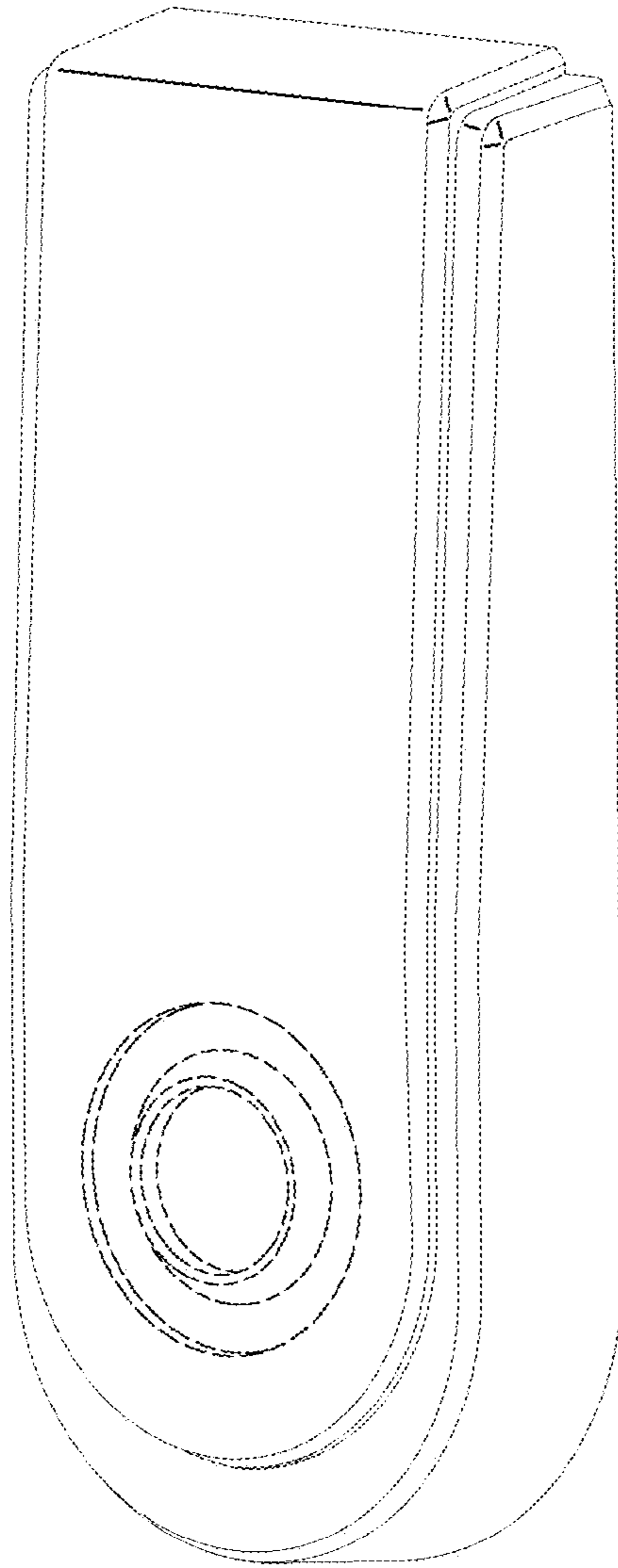

FIG. 1

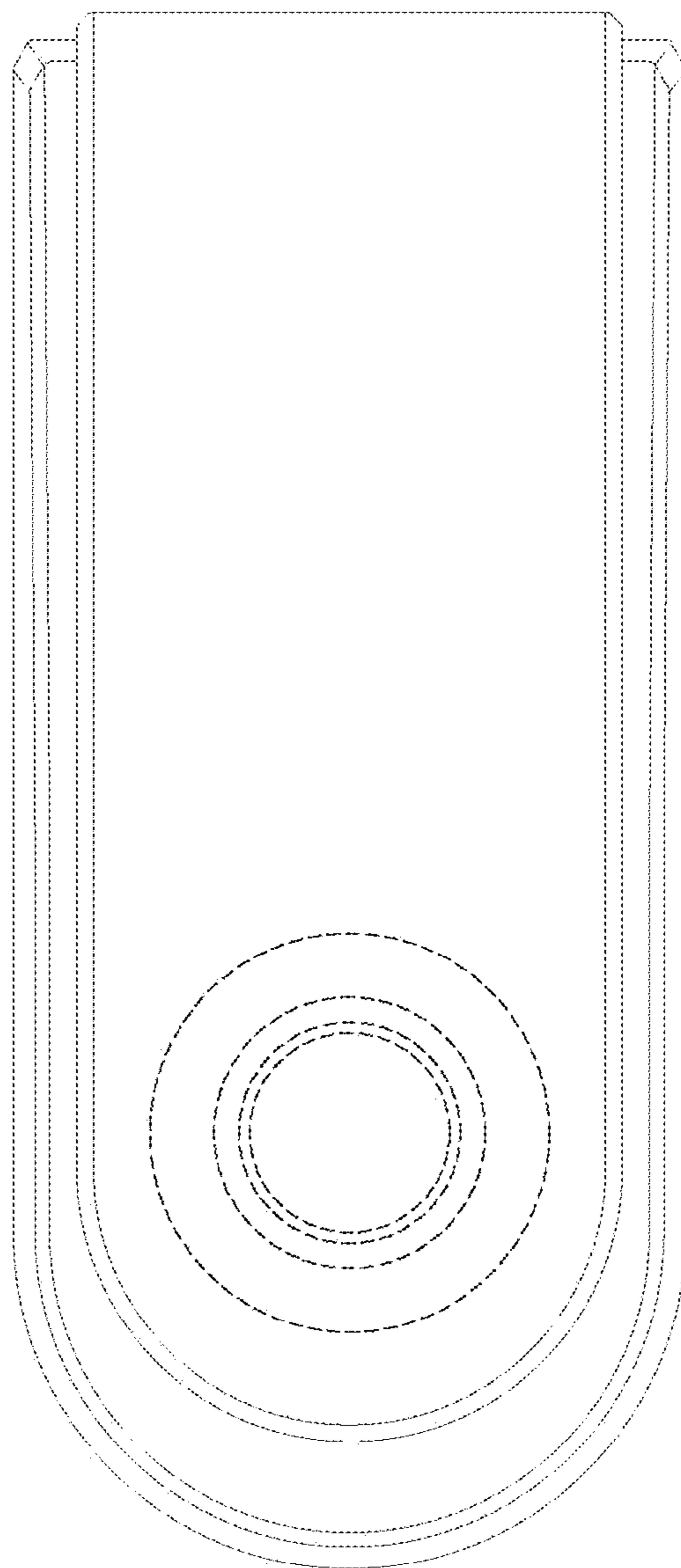

FIG. 2



FIG. 3

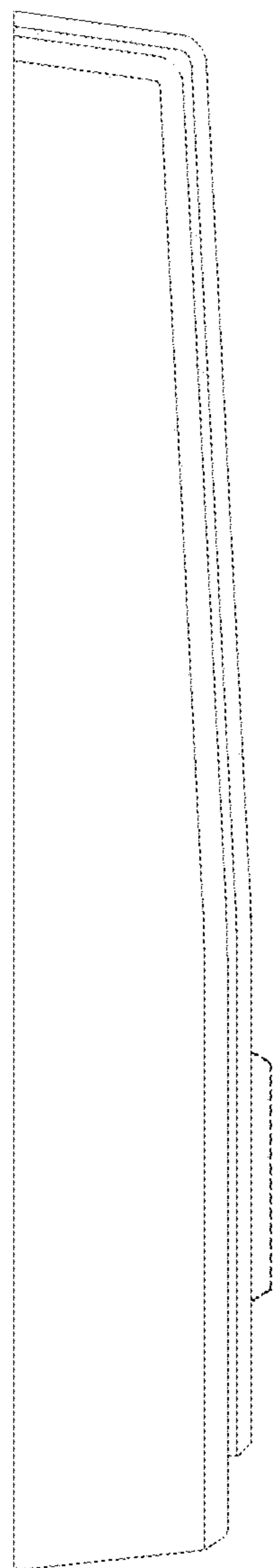

FIG. 4

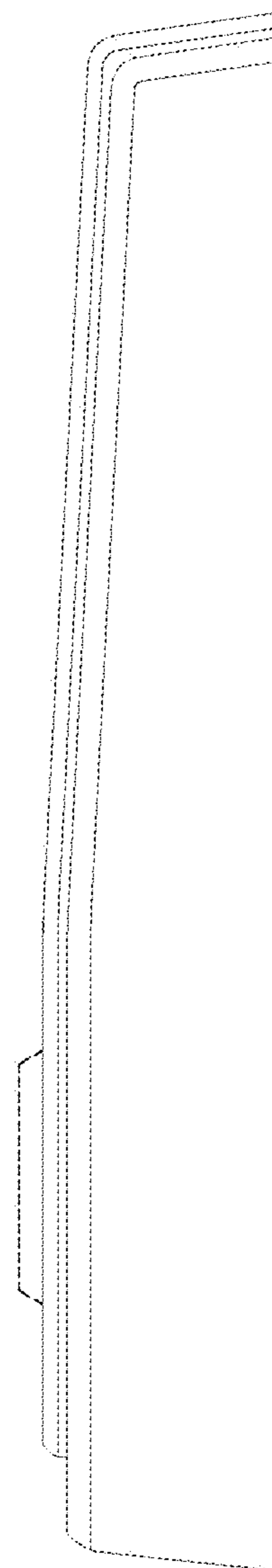

FIG. 5

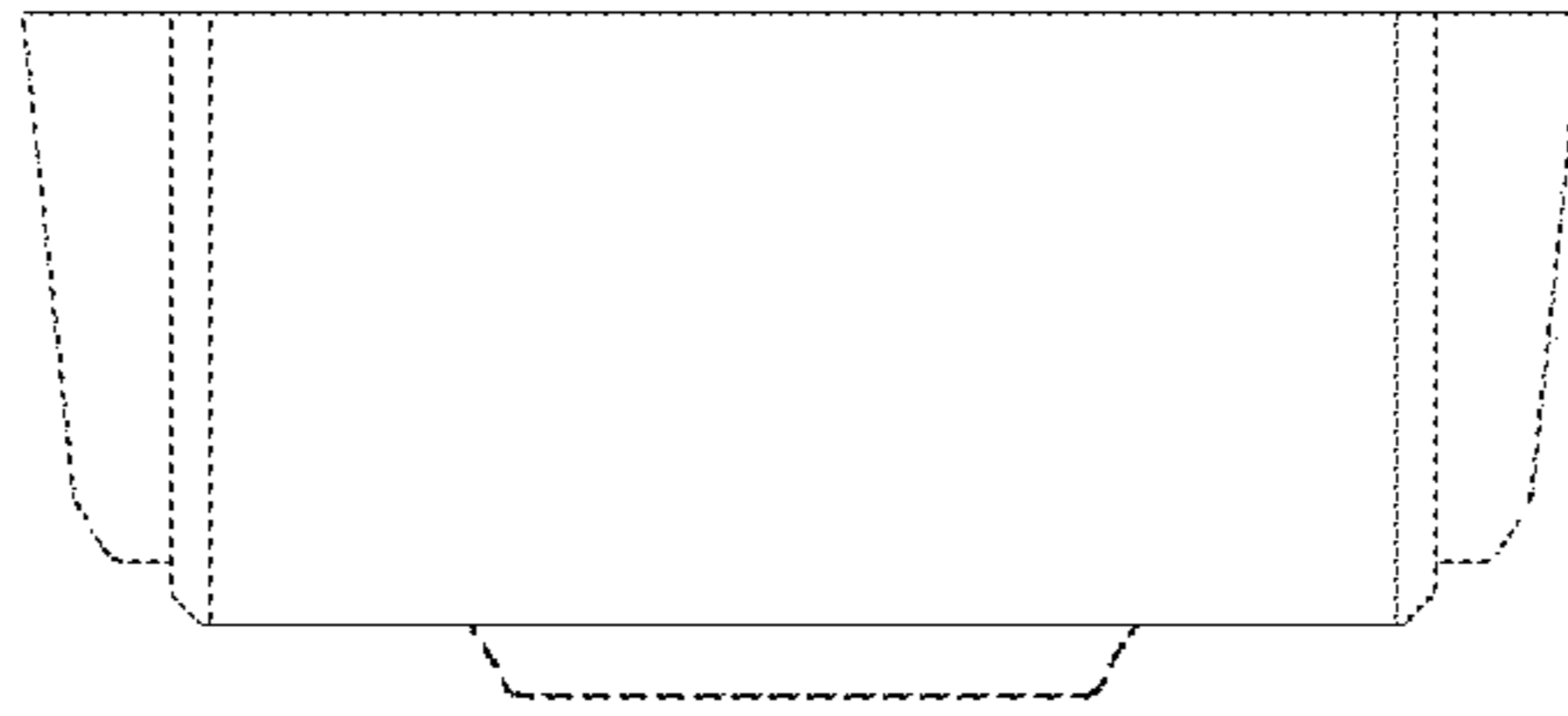

FIG. 6

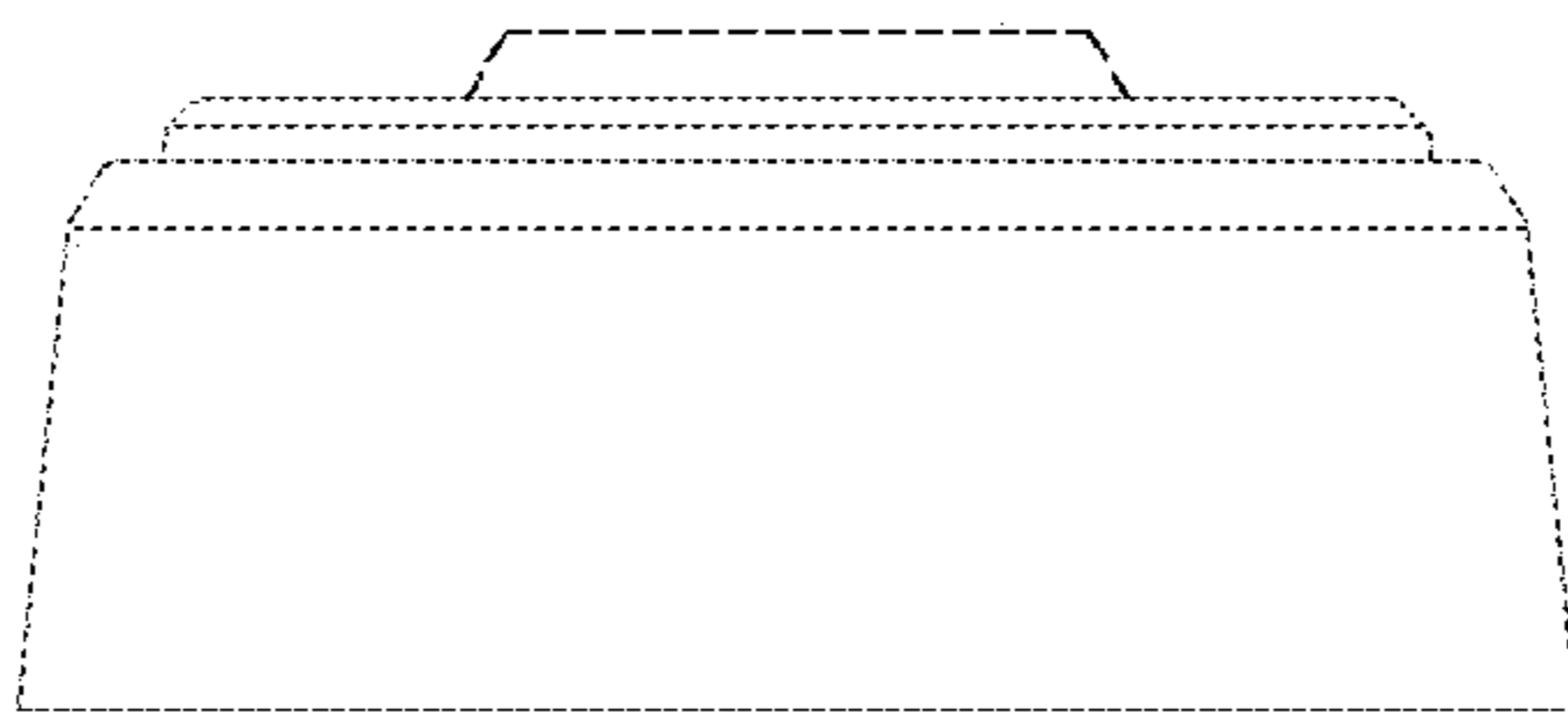

FIG. 7

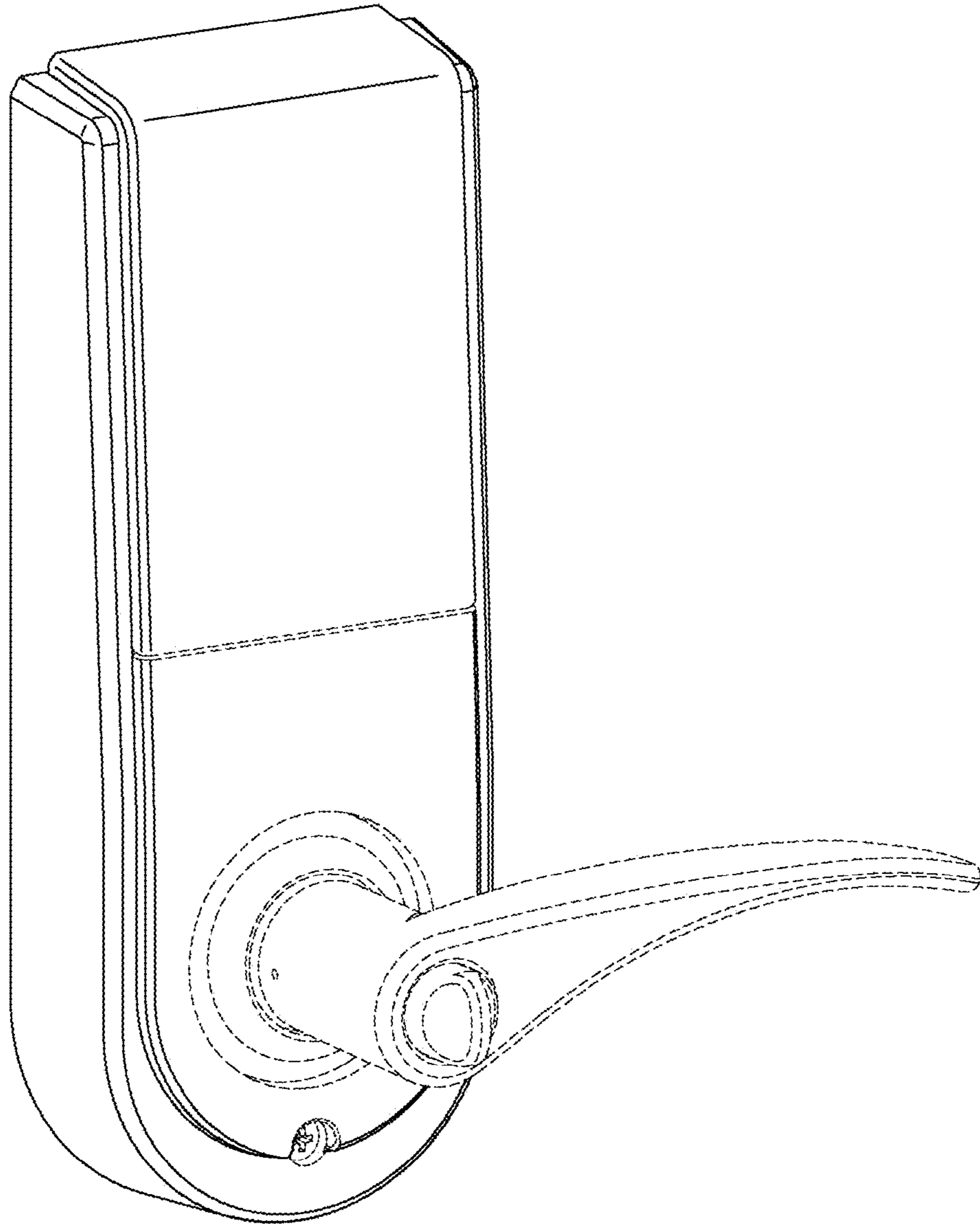

FIG. 8

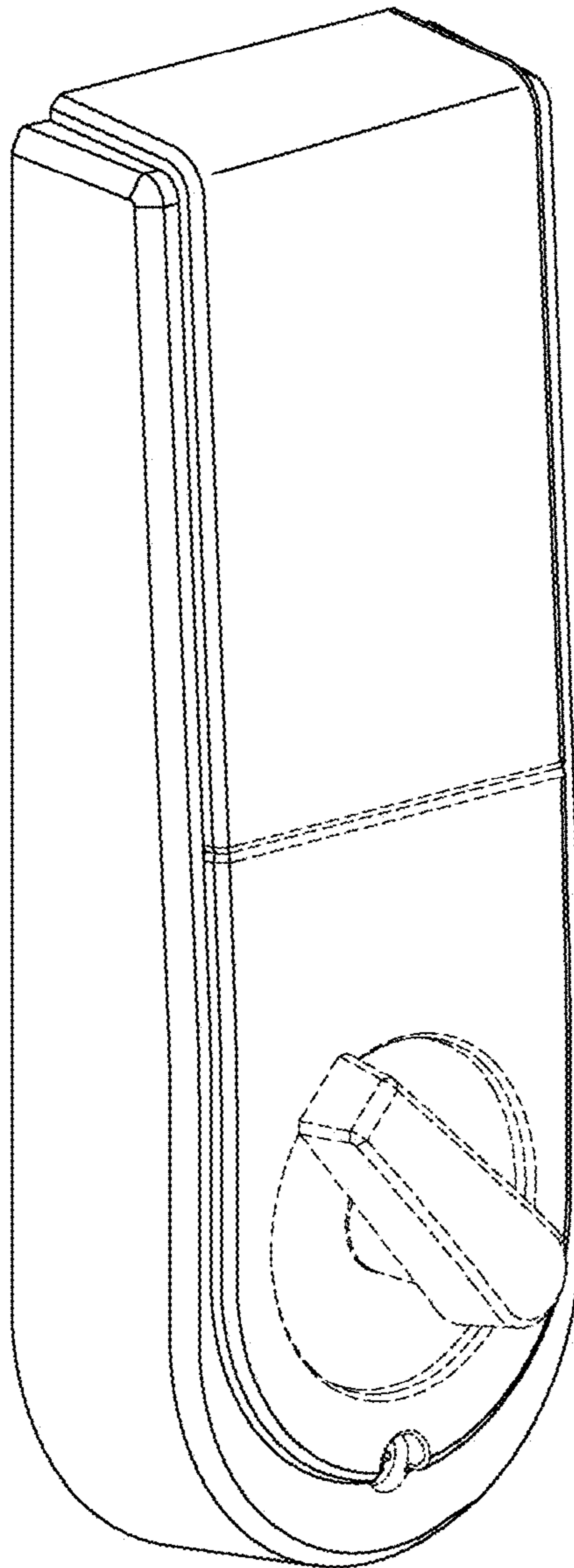

FIG. 9