



US00D679959S

(12) **United States Design Patent**  
**Lane**

(10) **Patent No.:** **US D679,959 S**

(45) **Date of Patent:** **\*\* Apr. 16, 2013**

(54) **FOOD JAR WITH LATCH-RELEASED HINGED LID**

D622,554 S \* 8/2010 Carreno ..... D7/629  
D629,657 S \* 12/2010 Carreno ..... D7/629  
D639,660 S 6/2011 Carreno

(75) Inventor: **Marvin Lane**, Round Lake Beach, IL (US)

\* cited by examiner

(73) Assignee: **Thermos, LLC**, Schaumburg, IL (US)

*Primary Examiner* — Terry Wallace

(74) *Attorney, Agent, or Firm* — Schiff Hardin LLP

(\*\*) Term: **14 Years**

(57) **CLAIM**

The ornamental design of the food jar with latch-released hinged lid, as shown and described.

(21) Appl. No.: **29/416,343**

**DESCRIPTION**

(22) Filed: **Mar. 21, 2012**

(51) **LOC (9) Cl.** ..... **07-07**

(52) **U.S. Cl.**  
USPC ..... **D7/629; D7/615**

(58) **Field of Classification Search** ..... D7/629,  
D7/602, 612–615, 608; D9/500, 503, 504,  
D9/516, 549, 559, 574, 575; 220/780–806,  
220/675, 574–575, 236, 326, 324, 4.23–4.25  
See application file for complete search history.

FIG. 1 is a perspective view taken from the upper, rear, right-hand side of the food jar with latch-released hinged lid of the present invention;

FIG. 2 is a perspective view taken from the lower, front, left-hand side of the food jar with latch-released hinged lid of FIG. 1;

FIG. 3 is a side elevational view of the left side of the food jar with latch-released hinged lid of FIG. 1;

FIG. 4 is a front elevational view of the food jar with latch-released hinged lid of FIG. 1;

FIG. 5 is a side elevational view of the right side of the food jar with latch-released hinged lid of FIG. 1;

FIG. 6 is a rear elevational view of the food jar with latch-released hinged lid of FIG. 1;

FIG. 7 is a top plan view of the food jar with latch-released hinged lid of FIG. 1; and,

FIG. 8 is a bottom plan view of the food jar with latch-released hinged lid of FIG. 1.

(56) **References Cited**

U.S. PATENT DOCUMENTS

4,399,926	A	*	8/1983	Eidels-Dubovoy	.....	220/773
D405,654	S	*	2/1999	Moran	.....	D7/629
6,253,947	B1	*	7/2001	Yang	.....	220/659
D557,076	S	*	12/2007	Wahl	.....	D7/629
D557,994	S	*	12/2007	Wahl	.....	D7/629
D587,534	S	*	3/2009	Carreno	.....	D7/629
D590,667	S	*	4/2009	Trombly	.....	D7/629
D593,372	S	*	6/2009	Carreno	.....	D7/629
D593,811	S	*	6/2009	Carreno	.....	D7/629

**1 Claim, 8 Drawing Sheets**

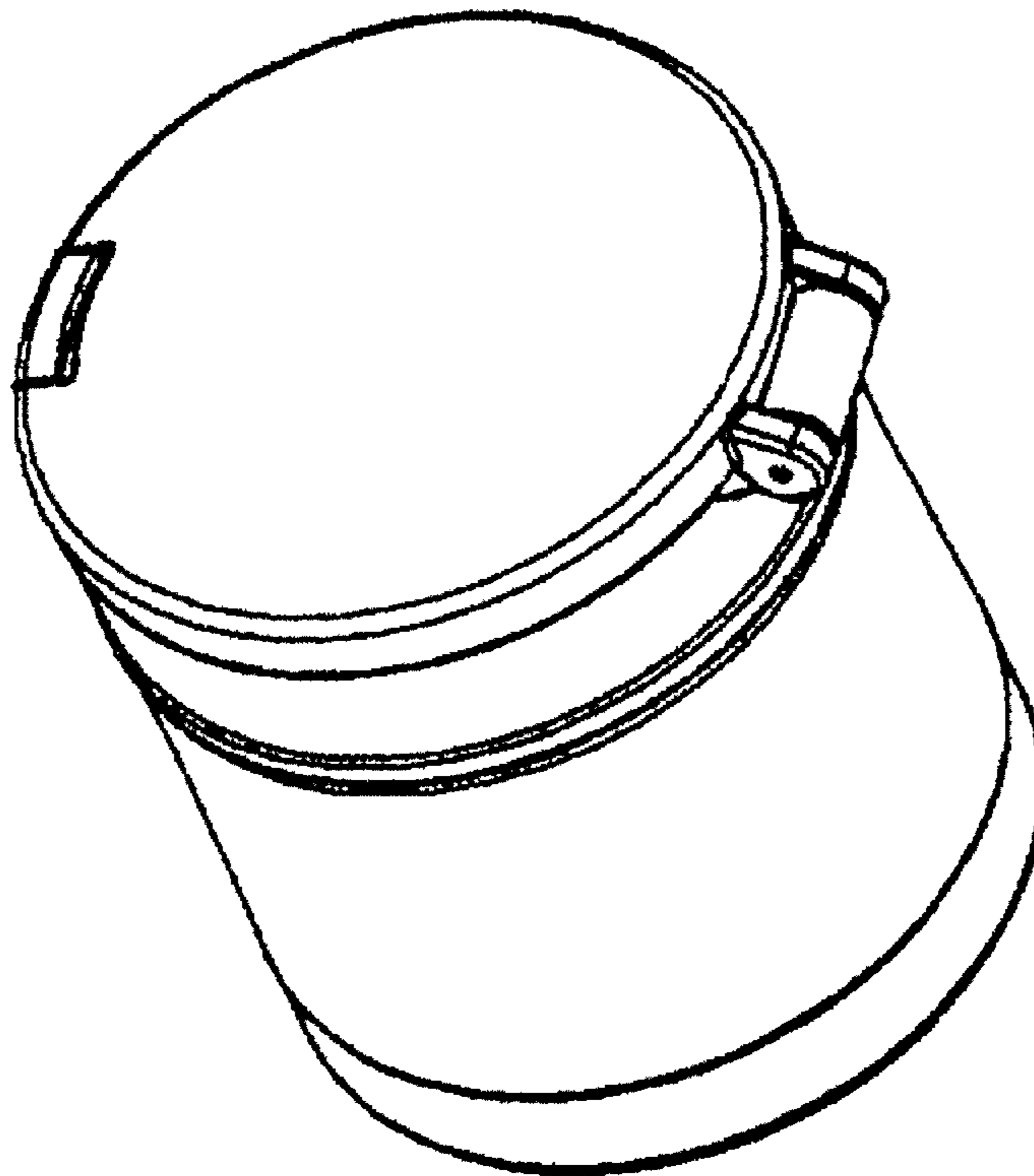

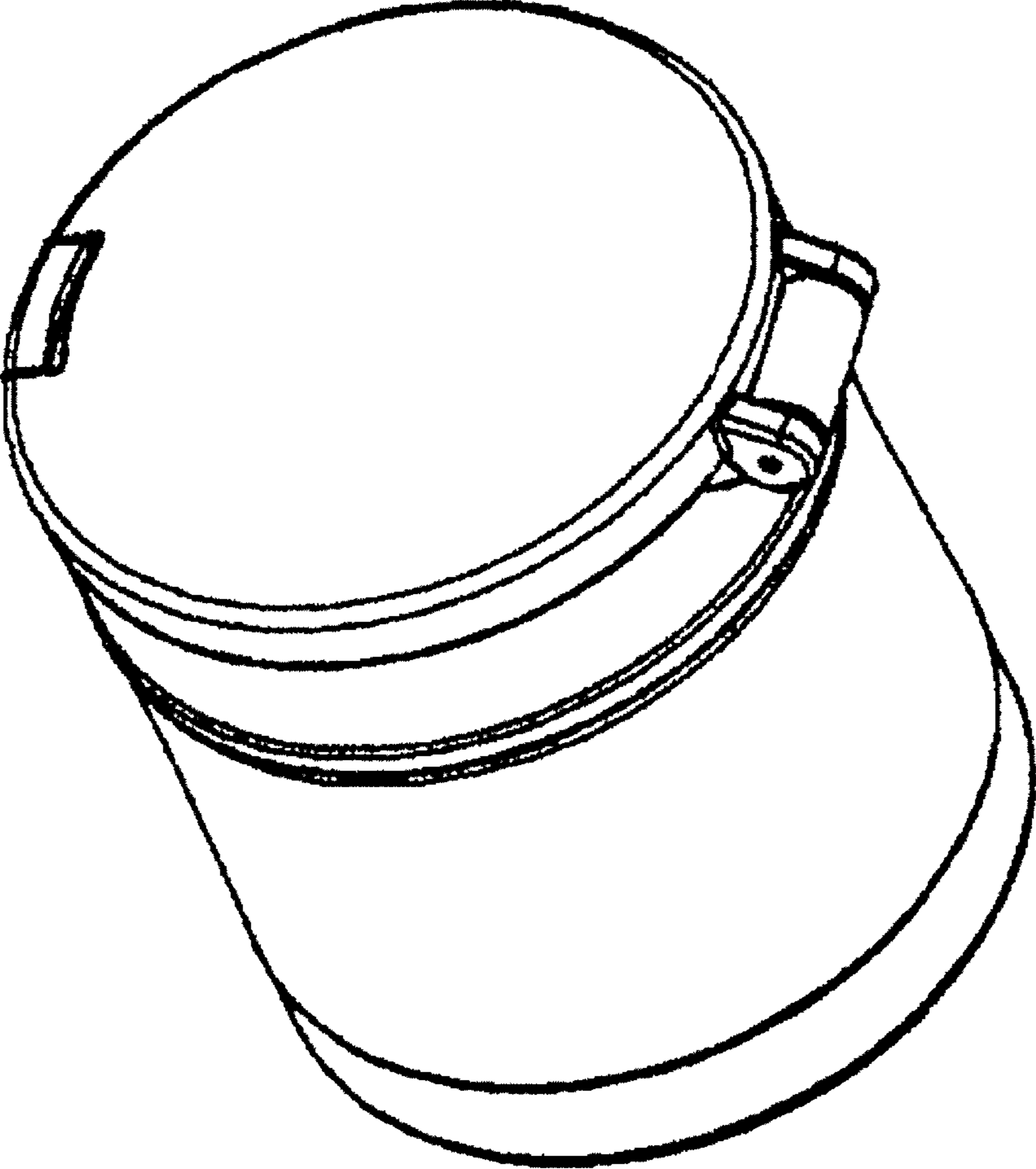

Figure 1

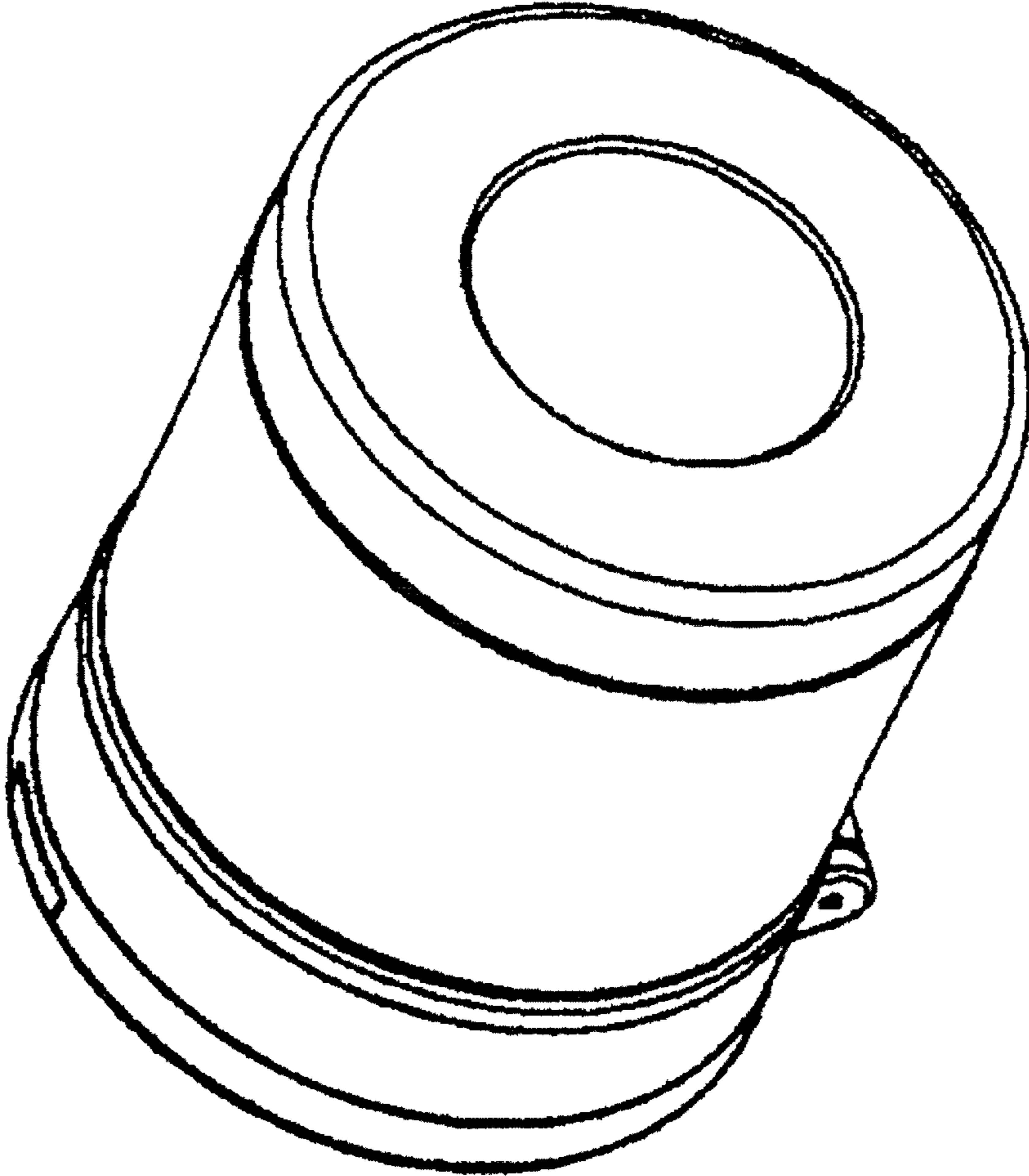

Figure 2

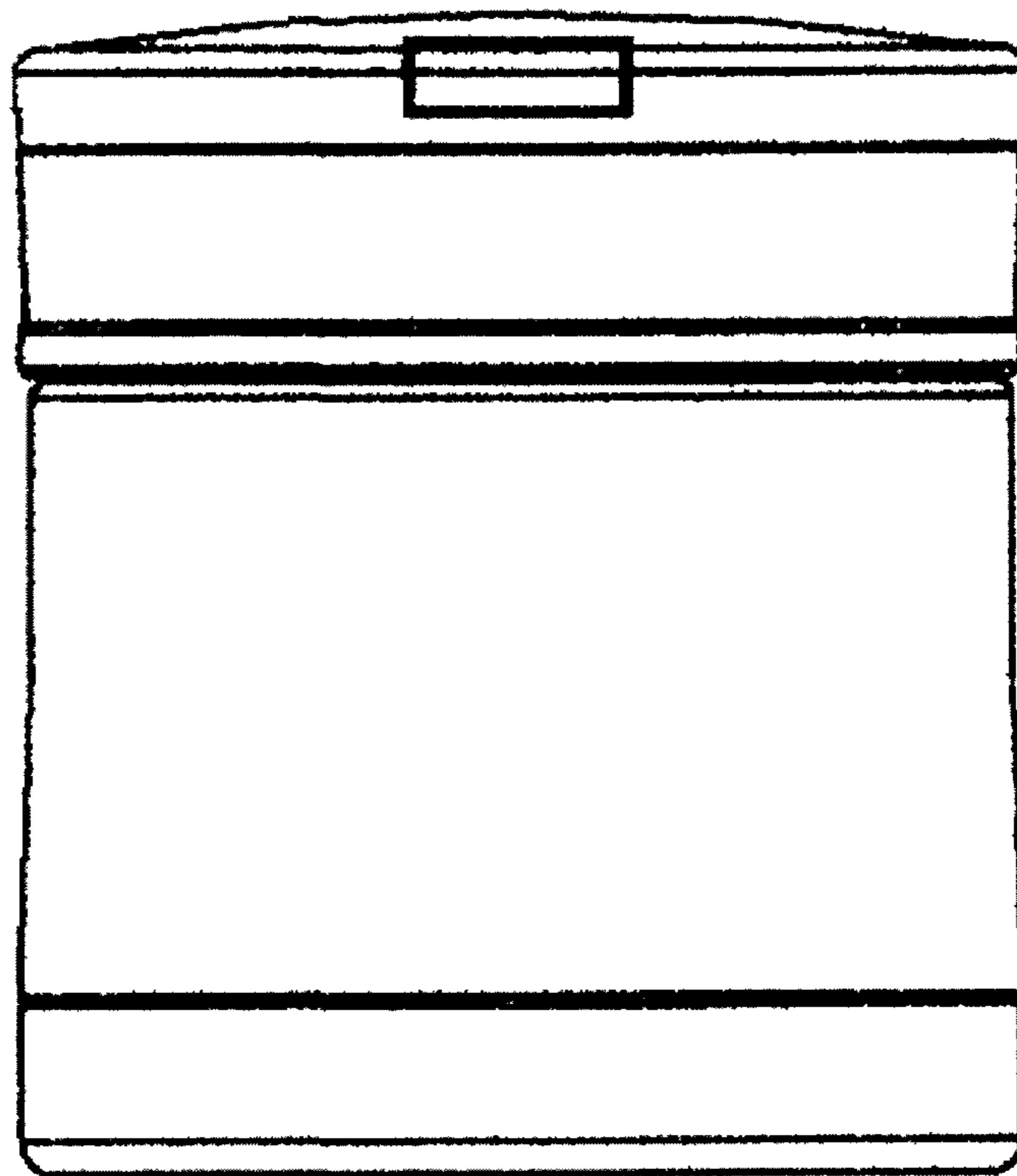

Figure 3

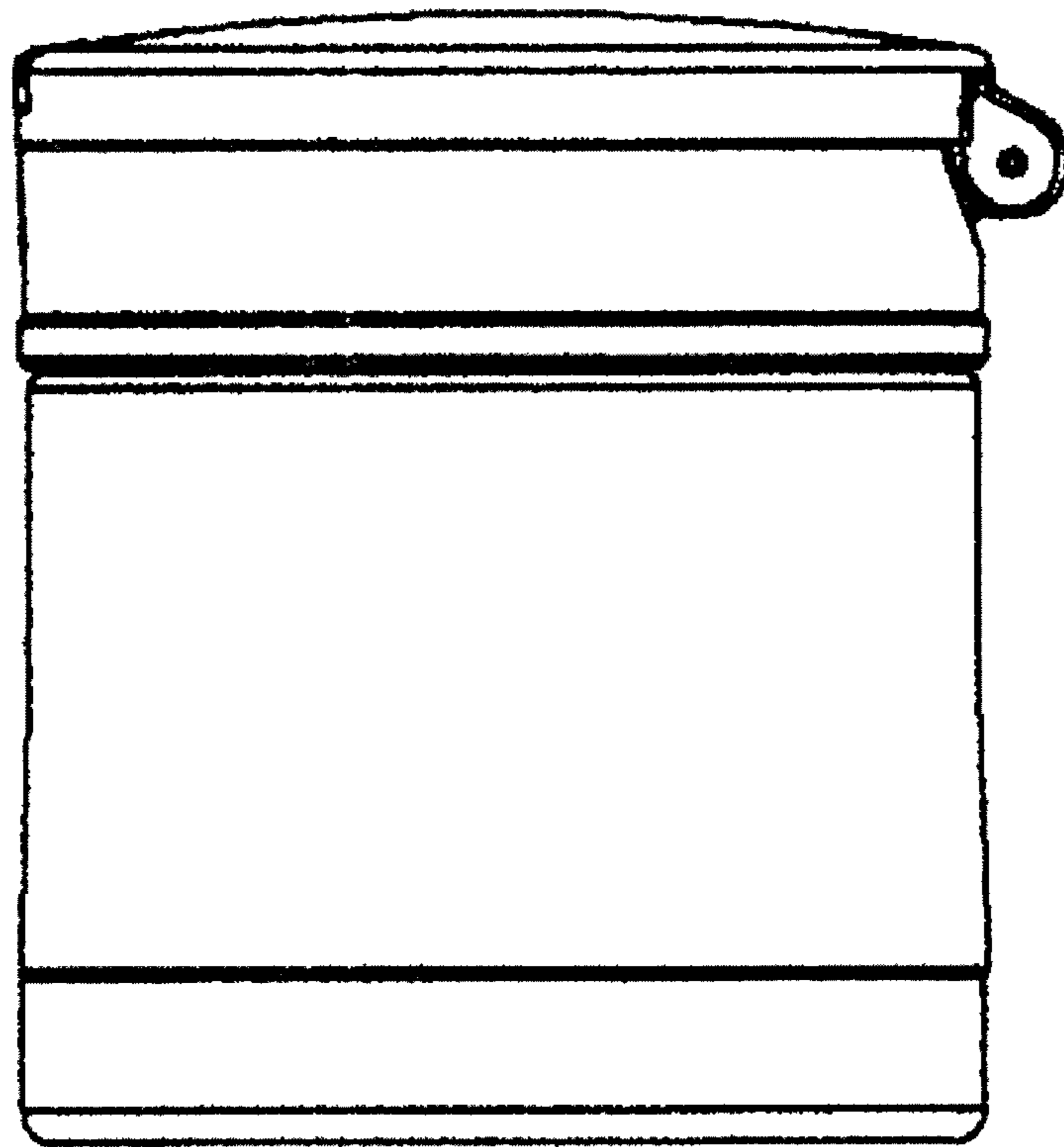

Figure 4

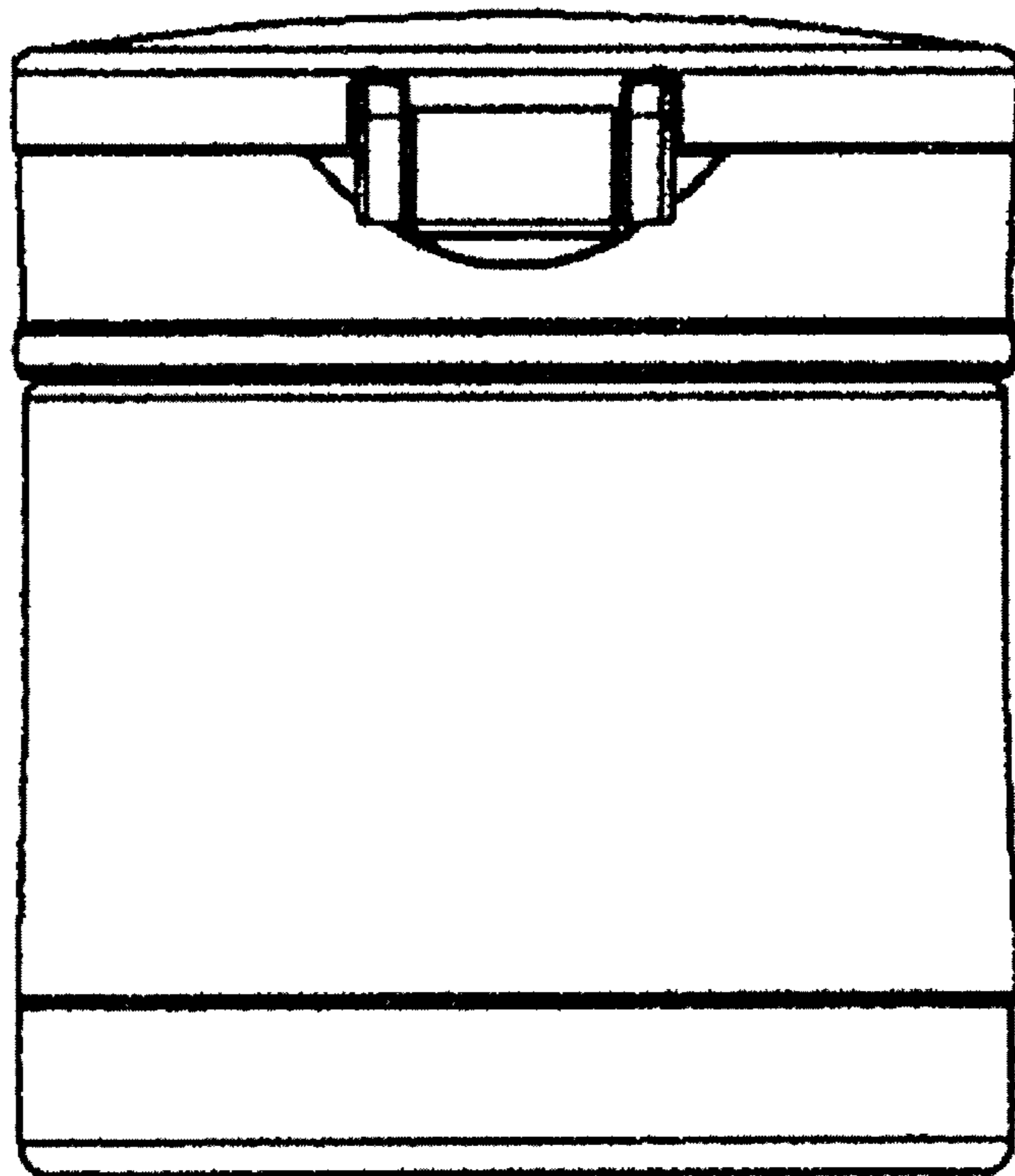

Figure 5

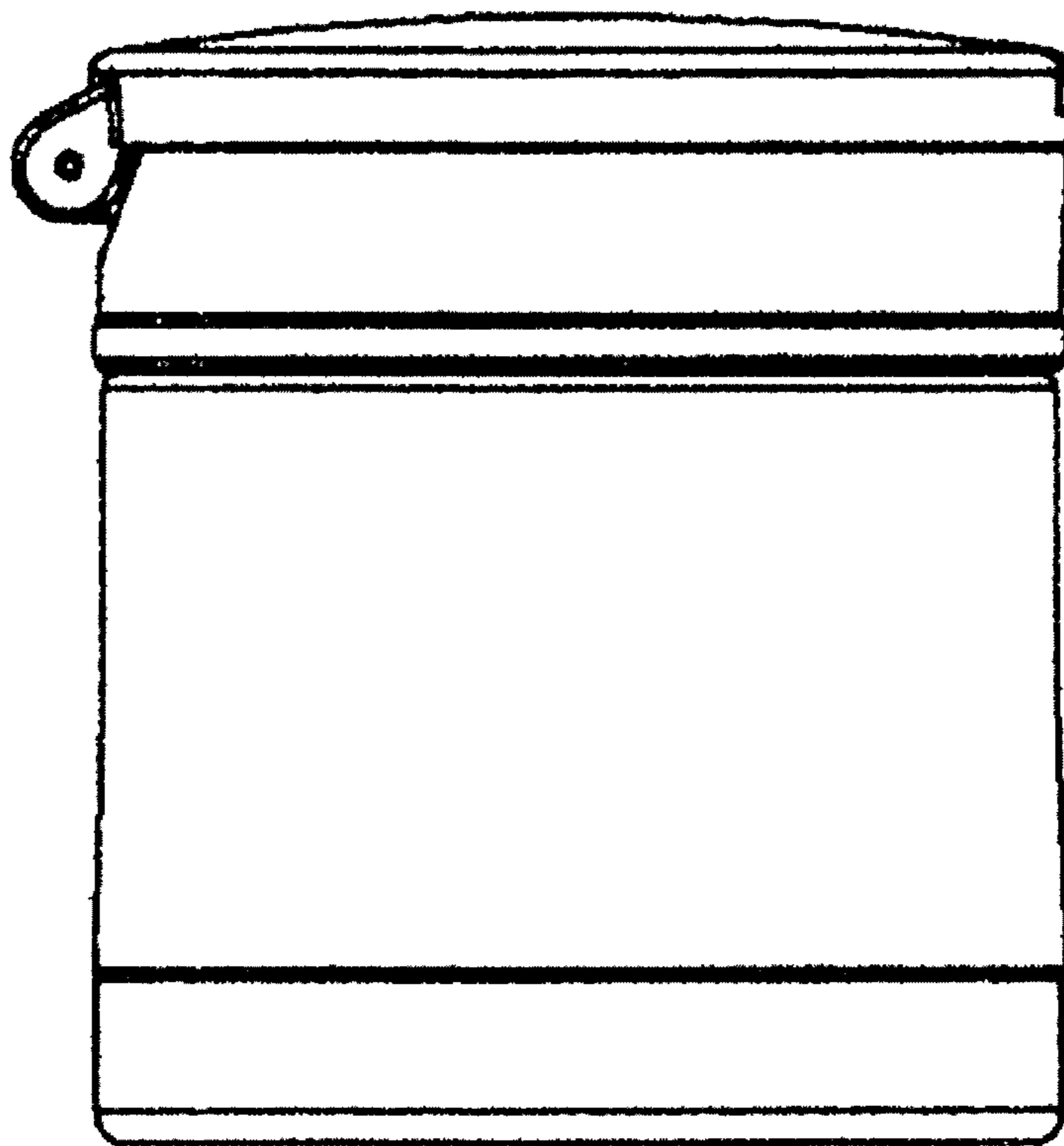

Figure 6

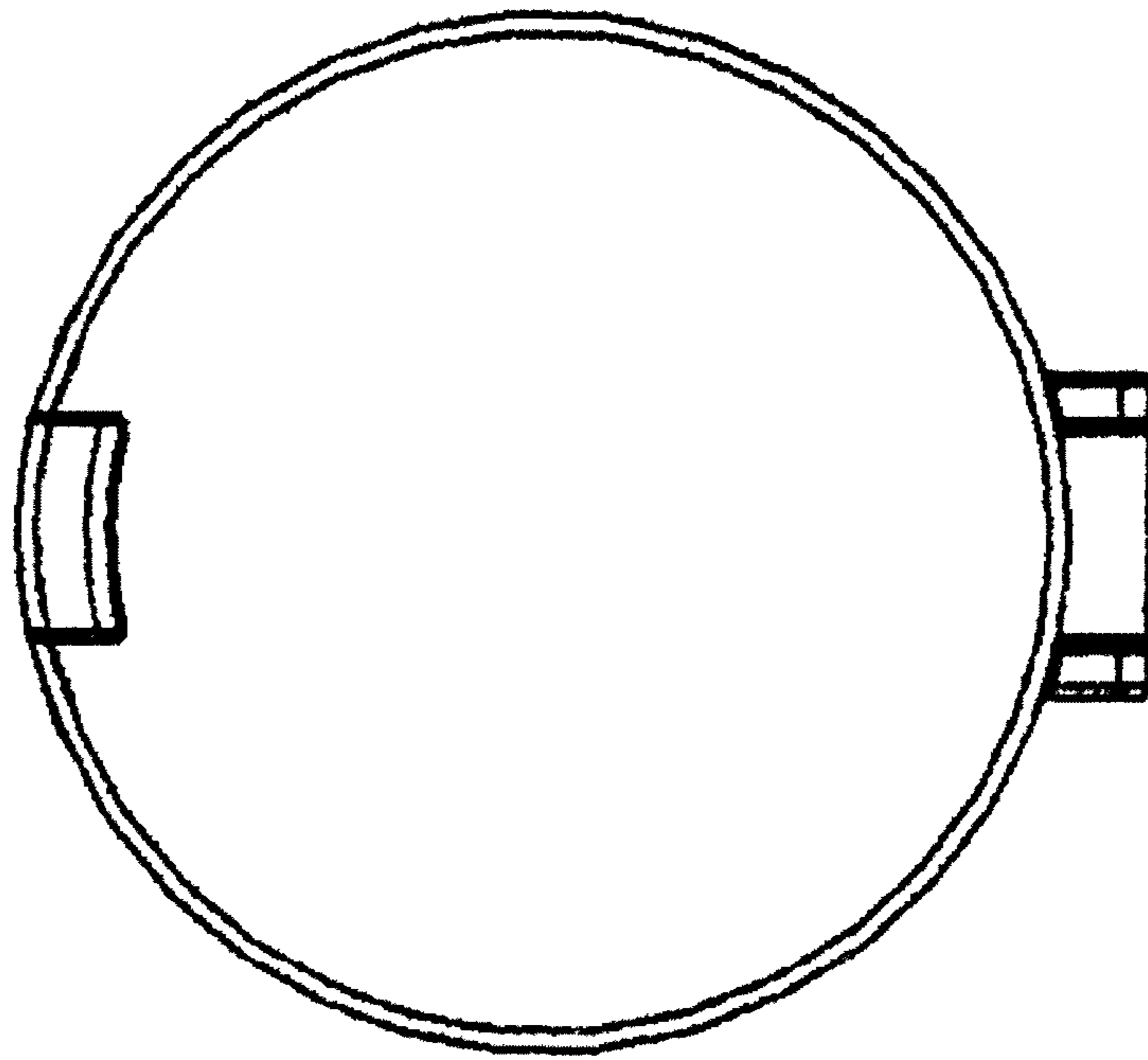

Figure 7



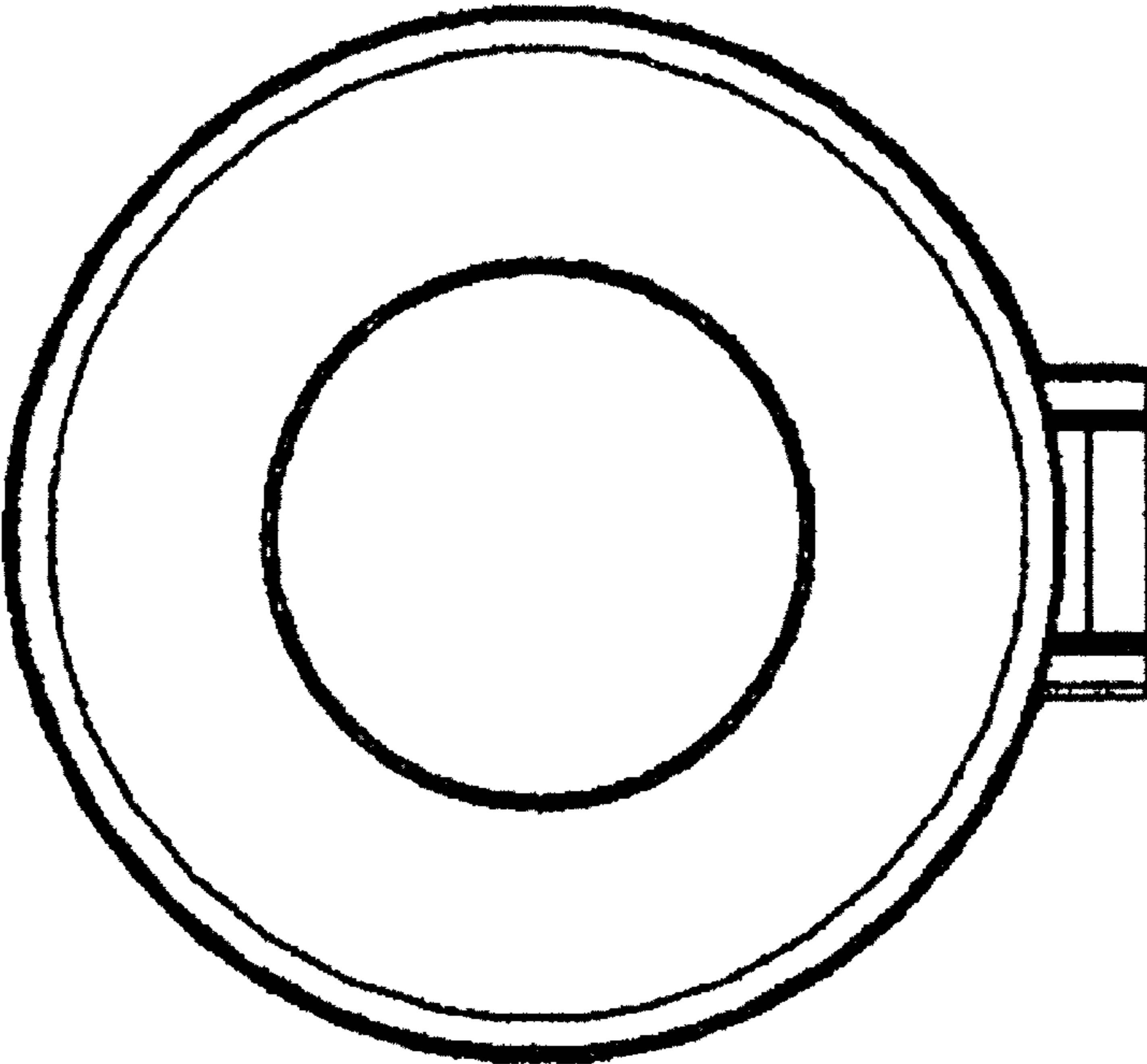

Figure 8