



US00D679879S

(12) **United States Design Patent**
Hemrajani

(10) **Patent No.:** **US D679,879 S**
(45) **Date of Patent:** **** Apr. 9, 2013**

- (54) **PORTABLE LAUNDRY HAMPER**
- (76) Inventor: **Kishore Hemrajani**, Great Neck, NY (US)
- (**) Term: **14 Years**
- (21) Appl. No.: **29/314,184**
- (22) Filed: **Mar. 11, 2009**
- (51) **LOC (9) Cl.** **08-99**
- (52) **U.S. Cl.** **D32/36**
- (58) **Field of Classification Search** D32/35, D32/36, 37; D3/301, 279, 273, 276, 281, D3/282, 283, 285, 287, 289; 190/18 A, 110, 190/111, 112, 113, 107, 109, 115
See application file for complete search history.

7,314,126	B2	1/2008	Godshaw et al.	
2002/0125089	A1 *	9/2002	Davis et al.	190/107
2004/0207167	A1	10/2004	Kady	
2005/0077133	A1	4/2005	Cassegrain	
2006/0118376	A1	6/2006	Godshaw et al.	
2007/0215425	A1	9/2007	Slater	
2012/0160626	A1 *	6/2012	Yang	190/18 A

* cited by examiner

Primary Examiner — T. Chase Nelson
Assistant Examiner — Ania Aman
(74) *Attorney, Agent, or Firm* — Collard & Roe, P.C.

(57) **CLAIM**
The ornamental design for a portable laundry hamper, as shown and described.

DESCRIPTION

FIG. 1 shows a perspective view of my design for a portable laundry hamper with the handle in a retracted position; FIG. 2 shows a rear elevational view thereof; FIG. 3 shows a front elevational view thereof; FIG. 4 shows a side elevational view thereof; FIG. 5 shows an opposite side elevational view thereof; FIG. 6 shows a top view thereof; FIG. 7 shows a bottom view thereof; and, FIG. 8 shows a perspective view as in FIG. 1, with the handle in an extended position.
The elements shown in broken lines depict environmental structure only and form no part of the claimed design.

- (56) **References Cited**
- U.S. PATENT DOCUMENTS
- 1,554,034 A 9/1925 Richie
- D129,848 S * 10/1941 Panzer D32/37
- 2,757,935 A 8/1956 Sofia
- D186,692 S * 11/1959 Davis D32/37
- 3,945,660 A 3/1976 Zalewski
- 4,094,351 A 6/1978 Catenaccio
- 4,759,559 A 7/1988 Moulton
- D457,314 S * 5/2002 Stephens et al. D3/289
- D459,579 S * 7/2002 Kegels D3/279
- 6,688,636 B2 2/2004 Han
- D495,459 S * 8/2004 Purnell D32/36

1 Claim, 5 Drawing Sheets

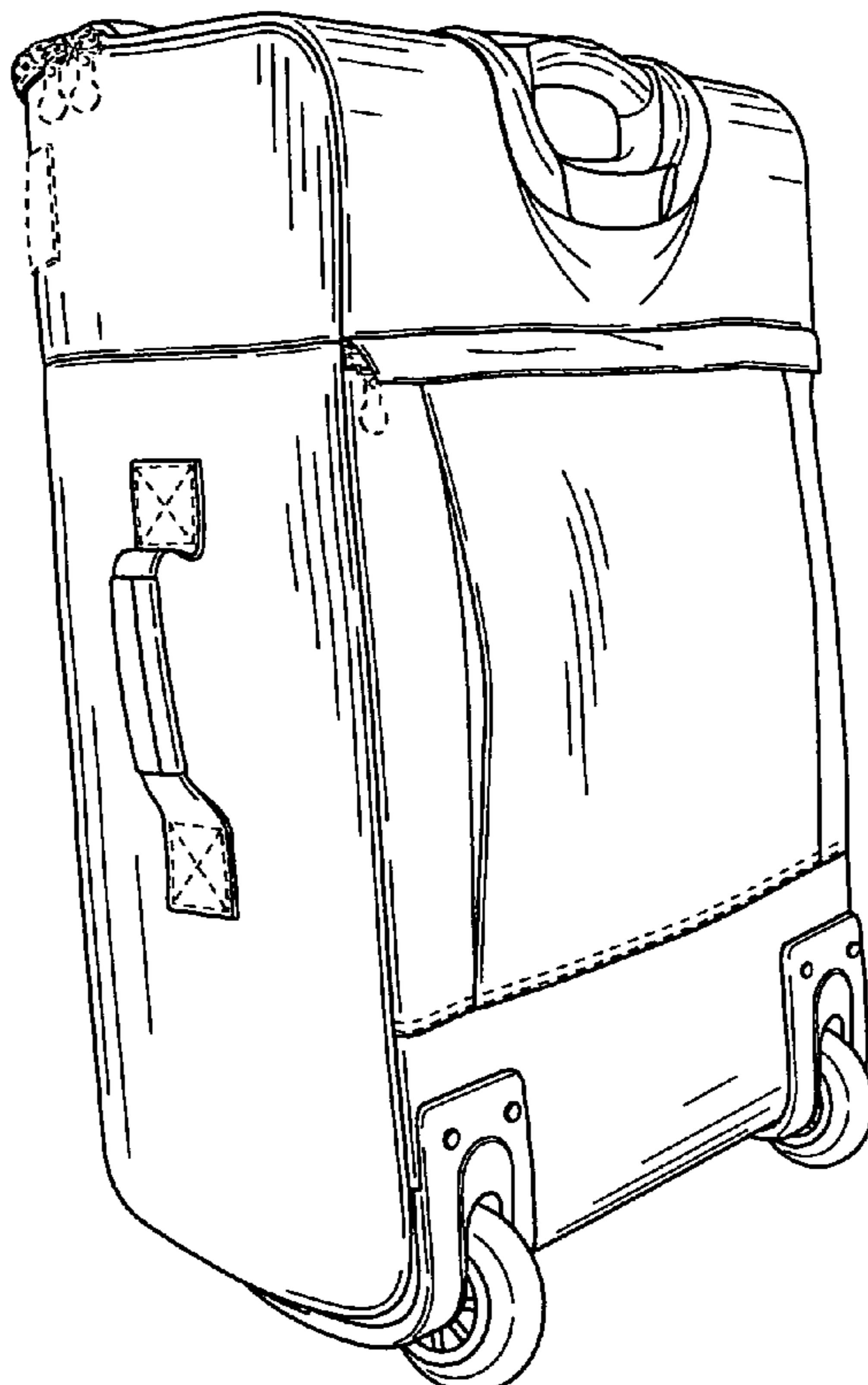

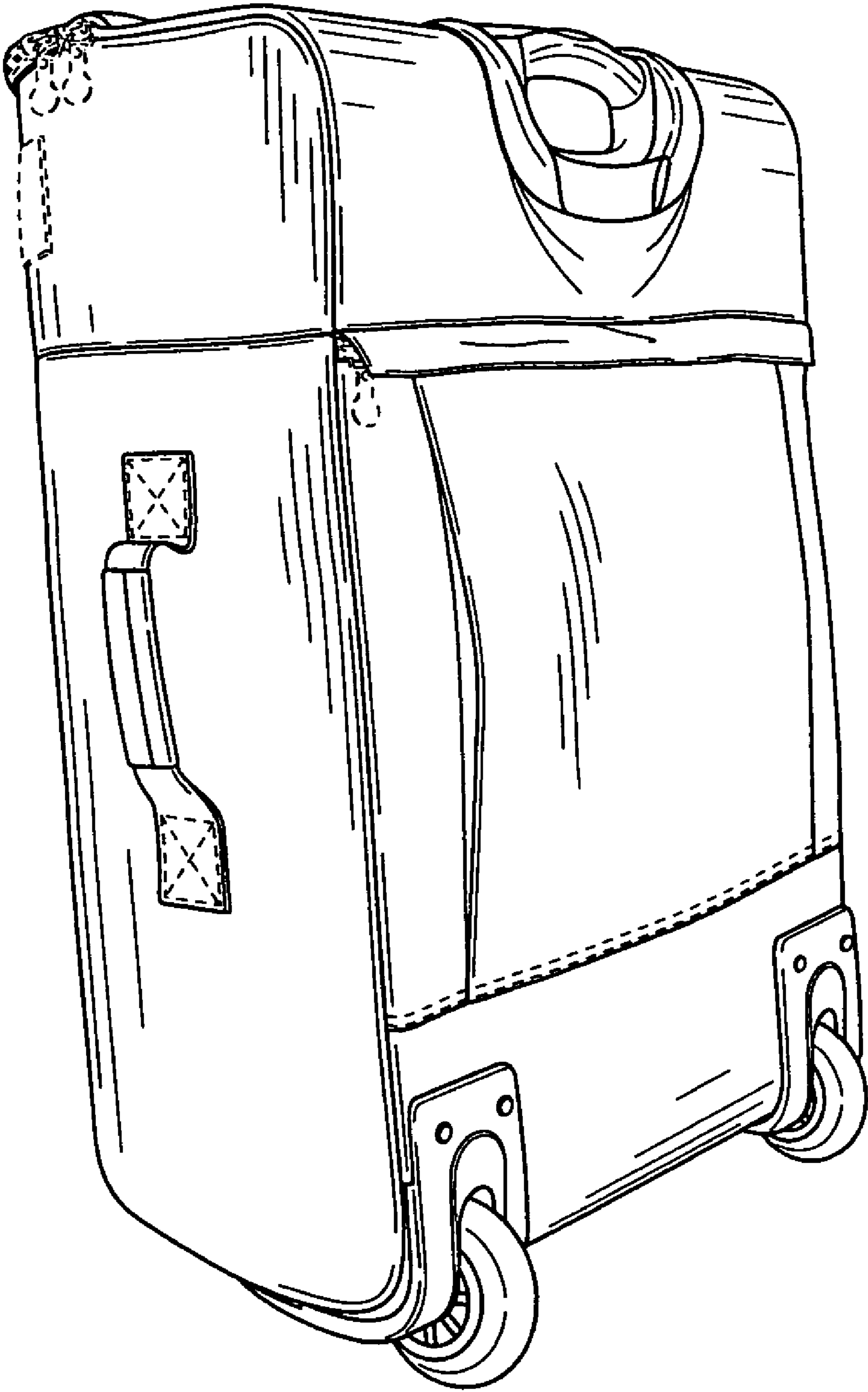

FIG. 1

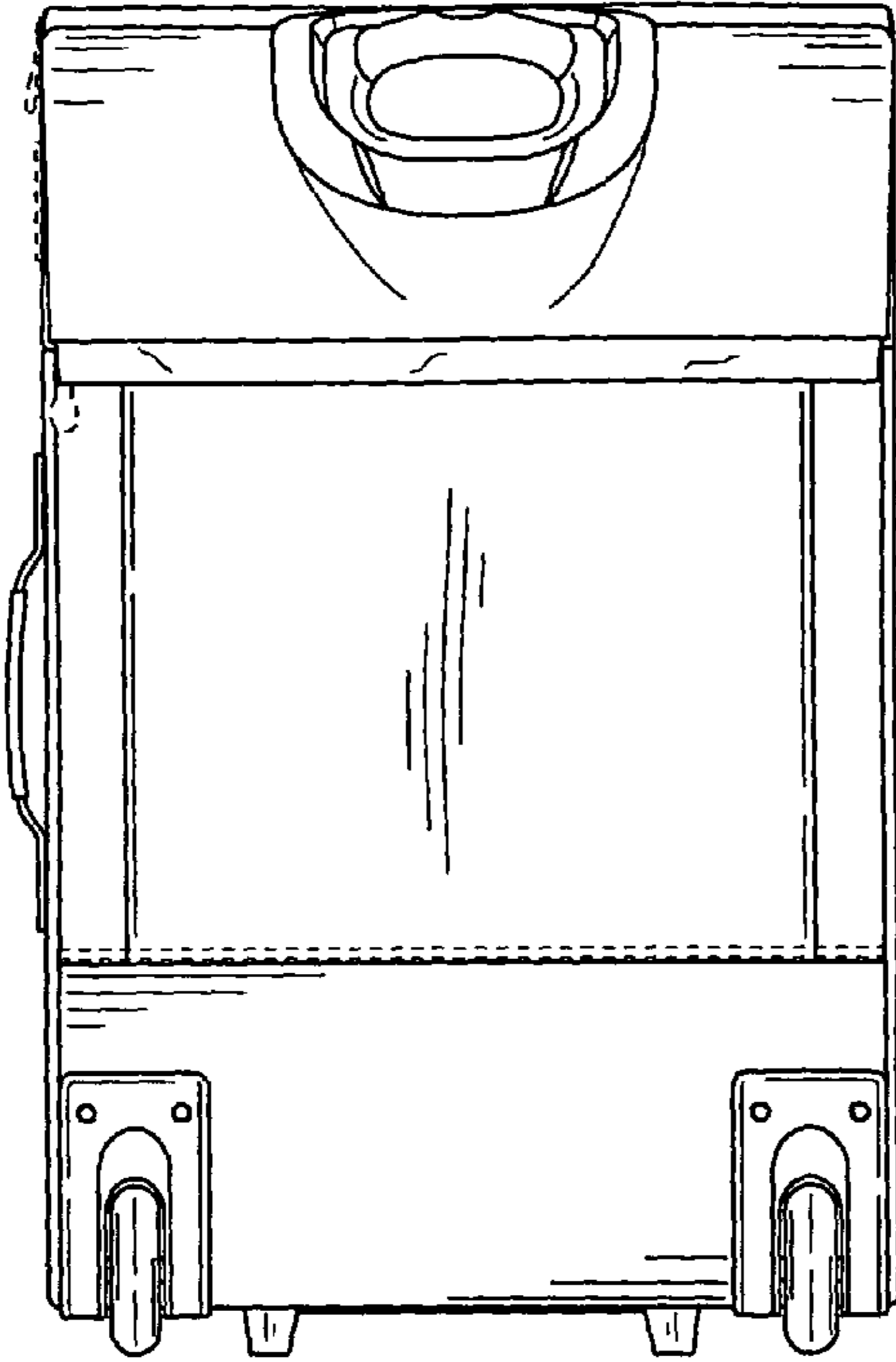

FIG. 2

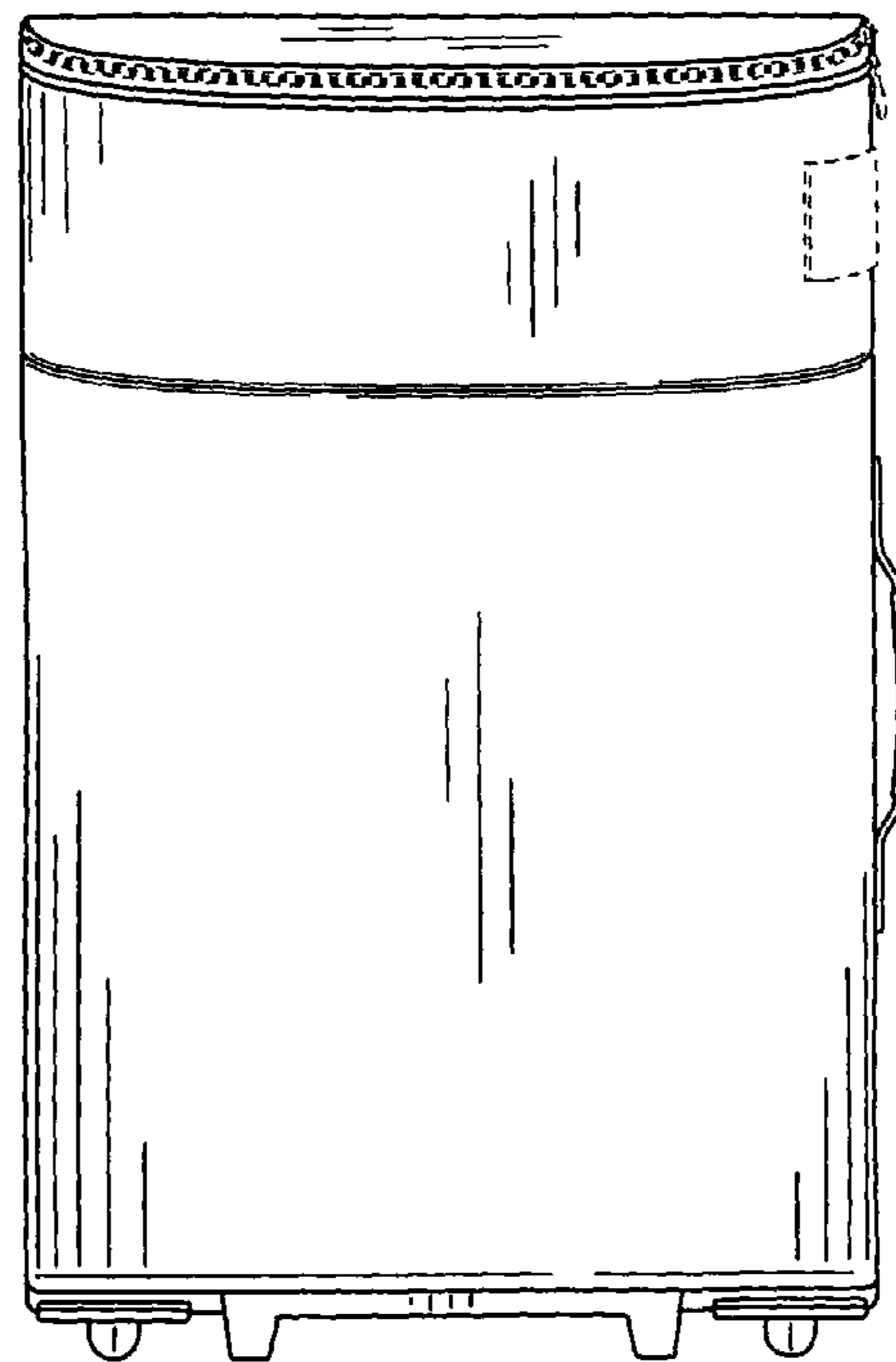

FIG. 3

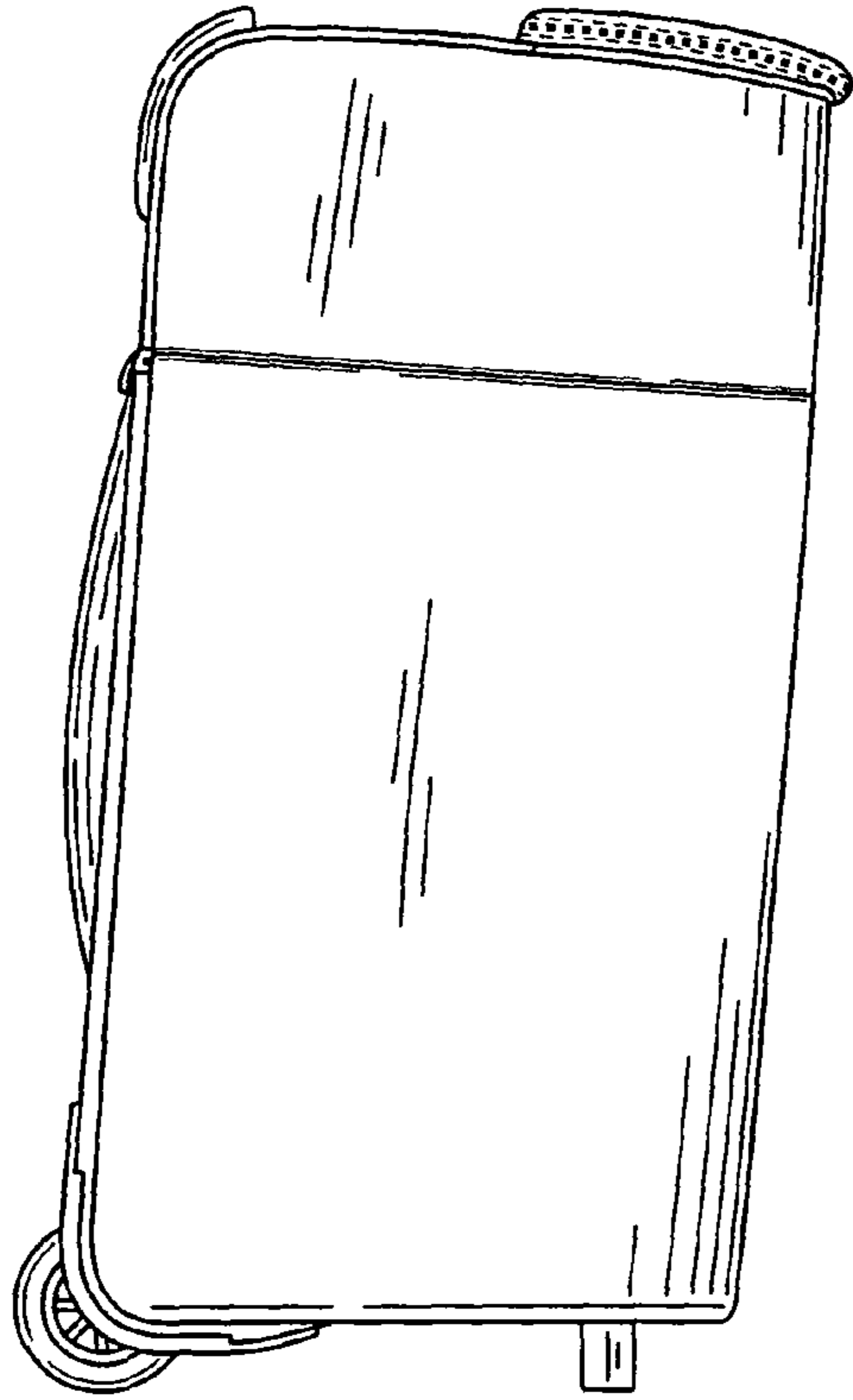

FIG. 4

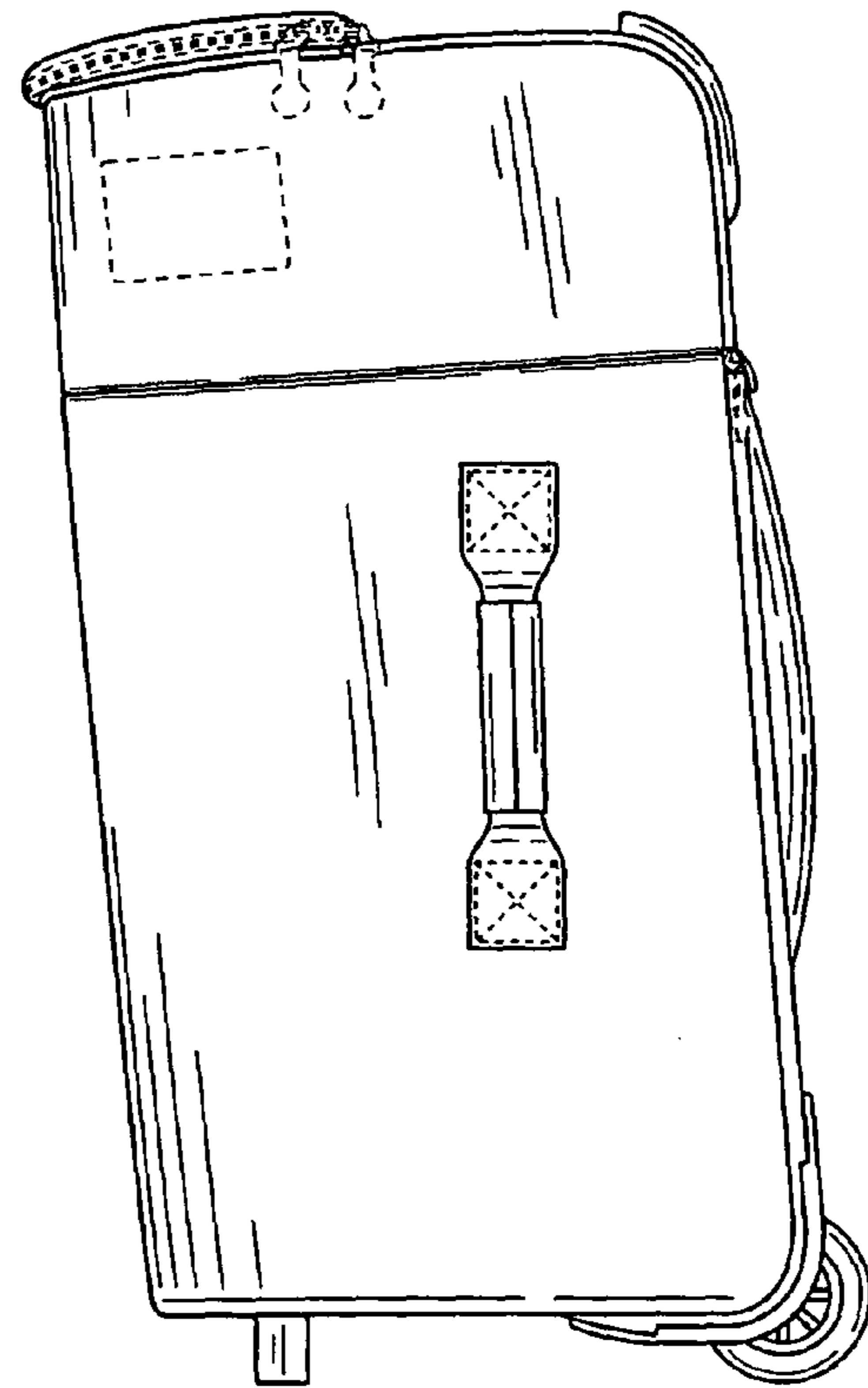

FIG. 5

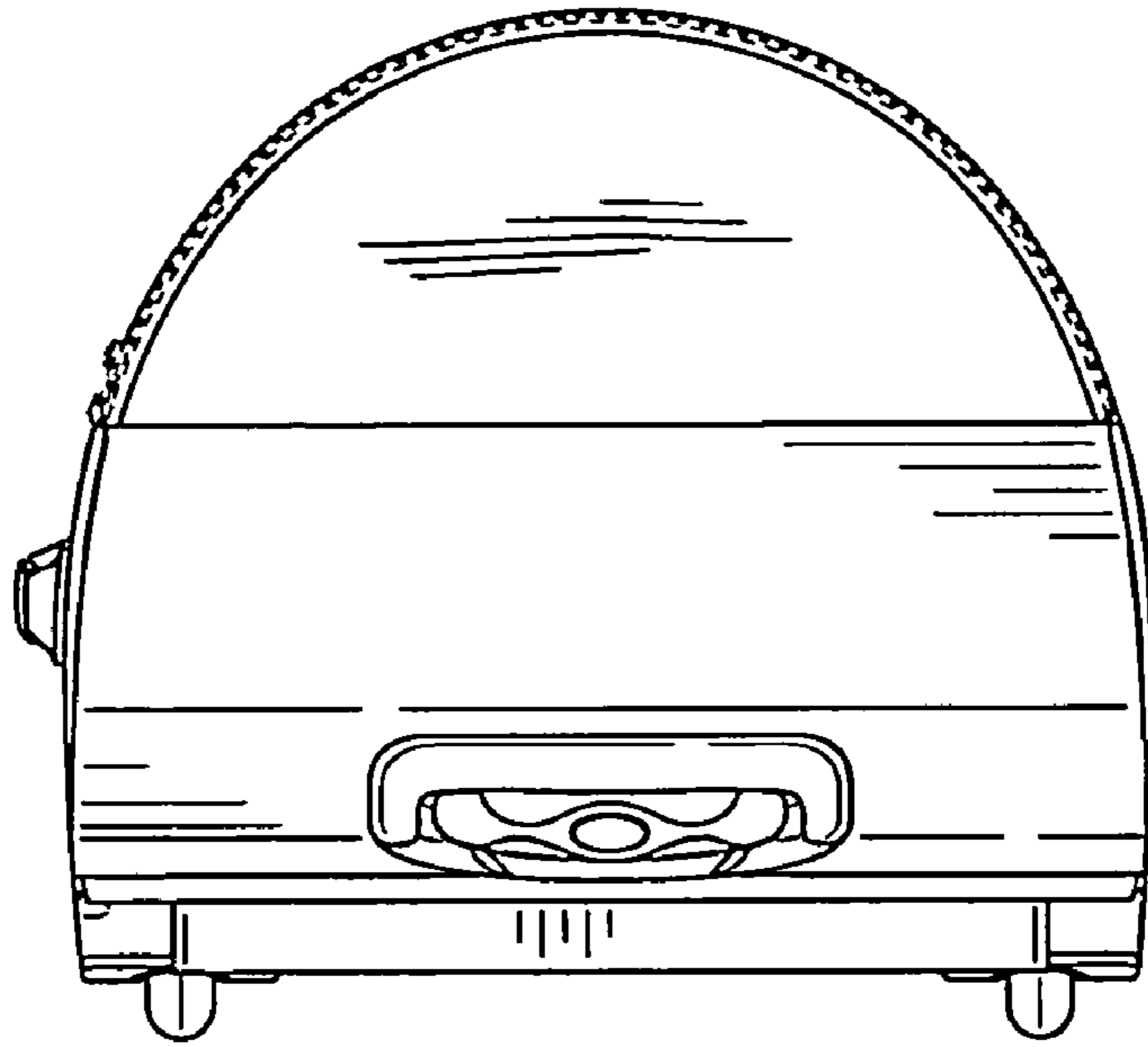

FIG. 6

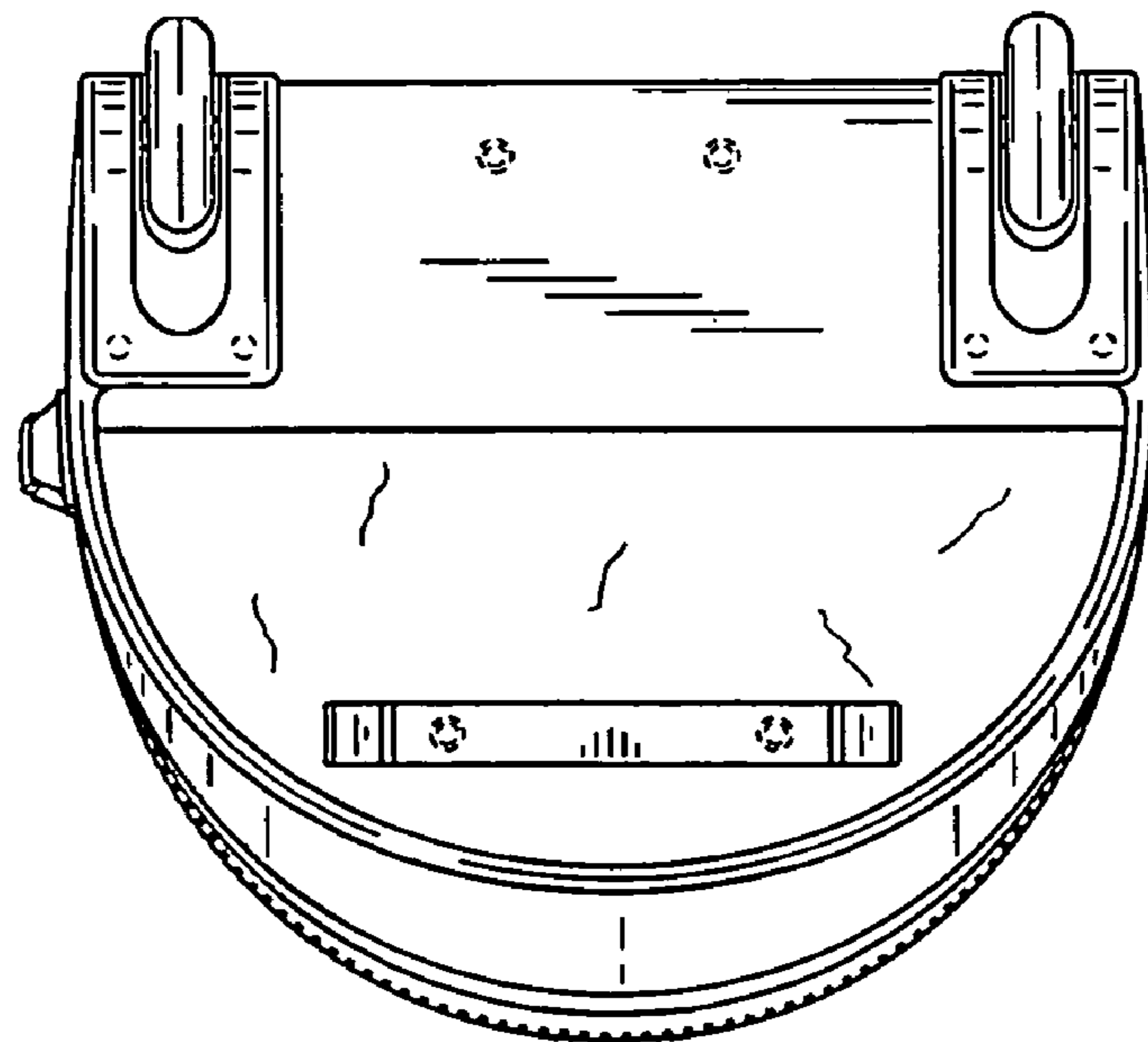

FIG. 7

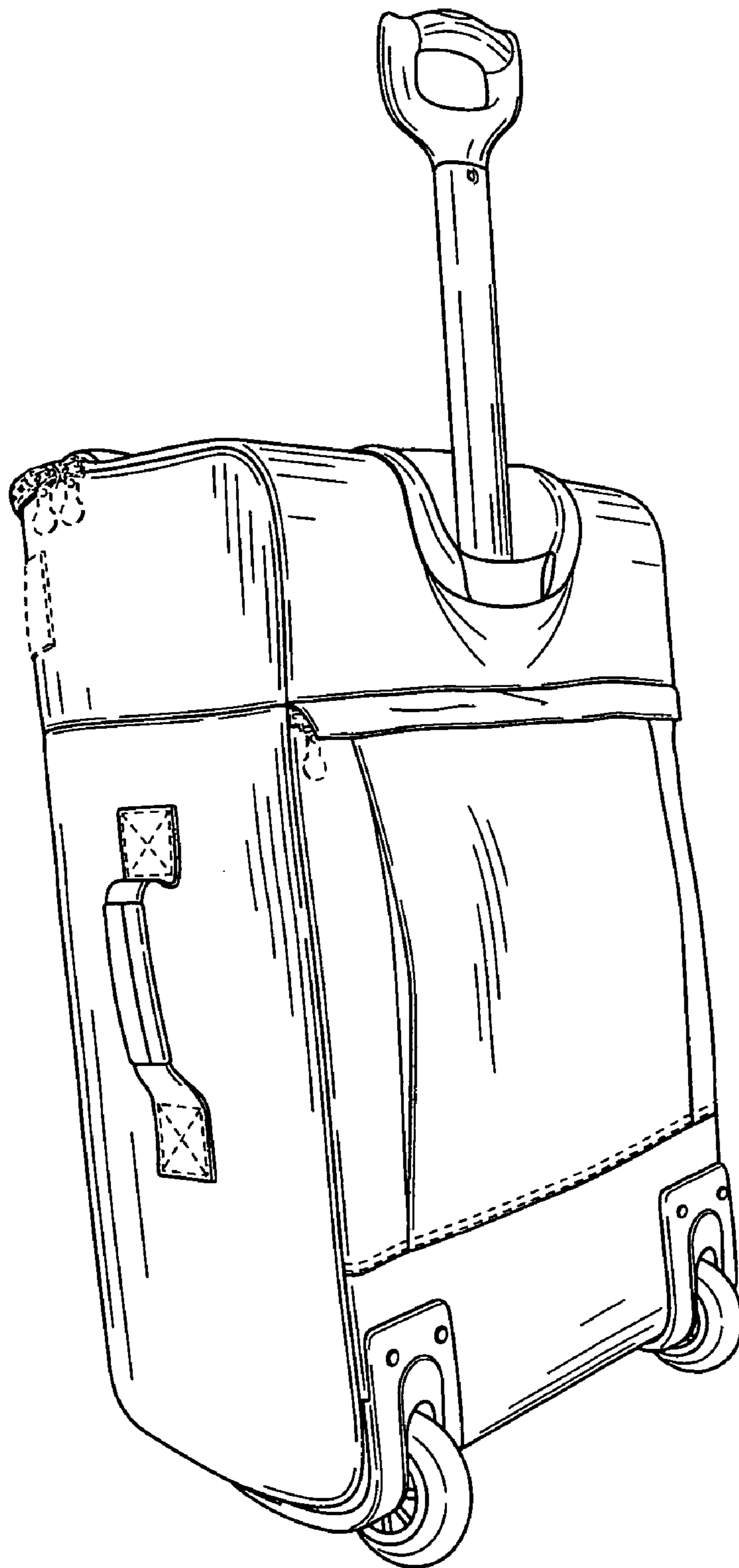

FIG. 8