

US00D679842S

(12) **United States Design Patent**  
**Joo et al.**

(10) **Patent No.:** **US D679,842 S**  
(45) **Date of Patent:** **\*\* Apr. 9, 2013**

(54) **HIGH BRIGHTNESS LED PACKAGE**

(75) Inventors: **Sung Chul Joo**, Cary, NC (US);  
**Christopher P. Hussell**, Cary, NC (US)

(73) Assignee: **Cree, Inc.**, Durham, NC (US)

(\*\*) Term: **14 Years**

(21) Appl. No.: **29/382,394**

(22) Filed: **Jan. 3, 2011**

(51) **LOC (9) Cl.** ..... **26-04**

(52) **U.S. Cl.**  
USPC ..... **D26/1**

(58) **Field of Classification Search** ..... D26/1-5;  
257/79-81, 88-89, 95-10; 313/483, 498-500;  
362/555, 800; D13/180

See application file for complete search history.

(56) **References Cited**

U.S. PATENT DOCUMENTS

4,679,118	A	7/1987	Johnson et al.
4,946,547	A	8/1990	Palmour
5,200,022	A	4/1993	Kong
5,210,051	A	5/1993	Carter, Jr.
RE34,861	E	2/1995	Davis et al.
5,393,993	A	2/1995	Edmond
5,506,446	A	4/1996	Hoffman et al.
5,523,589	A	6/1996	Edmond
6,274,924	B1	8/2001	Carey et al.
6,610,563	B1	8/2003	Waitl
6,828,170	B2	12/2004	Roberts et al.
6,936,855	B1	8/2005	Harrah
6,943,433	B2	9/2005	Kamada
D514,073	S	1/2006	Suenaga
7,081,661	B2	7/2006	Takehara et al.
7,224,047	B2	5/2007	Carberry et al.
7,244,965	B2	7/2007	Andrews et al.
D566,055	S	4/2008	Kim
7,361,940	B2	4/2008	Kim et al.
D573,113	S	7/2008	Bando

(Continued)

FOREIGN PATENT DOCUMENTS

CN 200930286397.5 10/2010  
CN ZL 2011-30010728 1/2012

(Continued)

OTHER PUBLICATIONS

Notice of Allowance for Japanese Design Appl. No. 2010-026186 dated Mar. 29, 2011.

(Continued)

*Primary Examiner* — Marcus Jackson

(74) *Attorney, Agent, or Firm* — Jenkins, Wilson, Taylor & Hunt, P.A.

(57) **CLAIM**

The ornamental design for a high brightness LED package, as shown and described.

**DESCRIPTION**

FIG. 1 is a top perspective view of an high brightness LED package showing our design;  
FIG. 2 is a side view thereof;  
FIG. 3 is a top view thereof;  
FIG. 4 is a side view thereof opposite the view of FIG. 2;  
FIG. 5 is a bottom view thereof opposite the view of FIG. 3;  
FIG. 6 is a side view thereof;  
FIG. 7 is an opposing side view thereof; and,  
FIG. 8 is a bottom perspective view thereof.  
The dashed broken lines are for illustrative purposes only and form no part of the claimed design. The dot-dash broken lines represent boundaries of the claimed design. None of the broken lines form part of the claimed design.

**1 Claim, 2 Drawing Sheets**

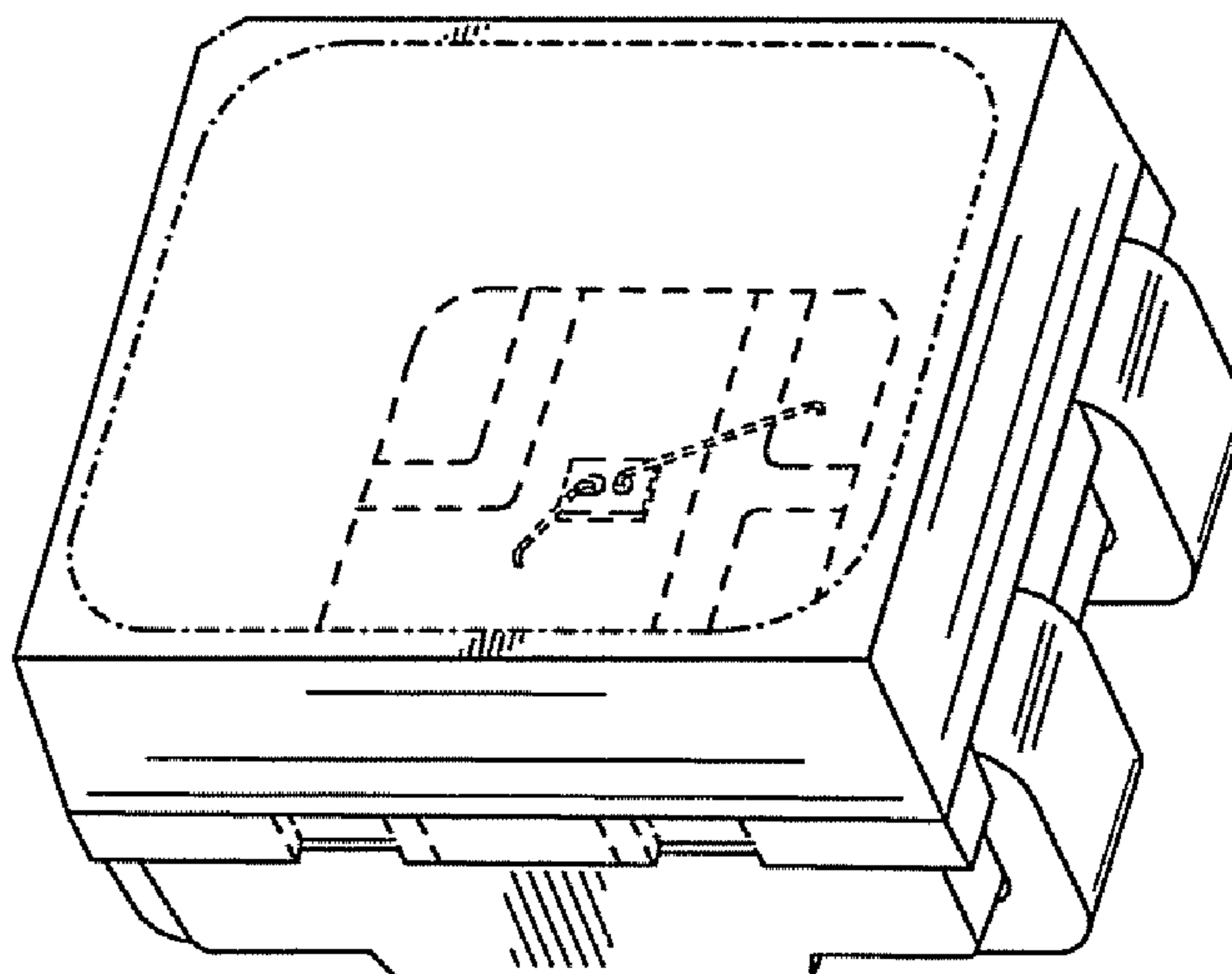

# US D679,842 S

## U.S. PATENT DOCUMENTS

D573,114	S	7/2008	Min et al.	
7,400,049	B2	7/2008	Shim	
7,429,790	B2	9/2008	Condie et al.	
7,432,589	B2	10/2008	Yamamoto et al.	
D580,375	S	11/2008	Yen	
D580,381	S	11/2008	Bando	
D580,891	S	11/2008	Sung et al.	
7,456,499	B2	11/2008	Loh	
7,462,870	B2	12/2008	Nakashima	
D584,699	S	1/2009	Bando	
D594,827	S	6/2009	Loh et al.	
D595,675	S	7/2009	Wang et al.	
7,564,180	B2	7/2009	Brandes	
D597,968	S	8/2009	Kobayakawa et al.	
D597,971	S	8/2009	Kobayakawa et al.	
D598,400	S	8/2009	Bando	
7,592,638	B2	9/2009	Kim	
D614,592	S	4/2010	Hussell et al.	
7,692,206	B2	4/2010	Loh	
D615,504	S	5/2010	Keller et al.	
7,719,024	B2	5/2010	Bando	
D621,798	S	8/2010	Lu et al.	
D621,799	S	8/2010	Hussell et al.	
D622,680	S	8/2010	Lin et al.	
7,791,061	B2	9/2010	Edmond et al.	
D626,095	S	10/2010	Hseih	
D627,310	S	11/2010	Lin et al.	
D628,541	S	12/2010	Lin	
D632,267	S	2/2011	Chen et al.	
D632,659	S	2/2011	Hseih	
D634,284	S	3/2011	Ko et al.	
D634,285	S	3/2011	Ko et al.	
D634,286	S	3/2011	Ko et al.	
D634,716	S *	3/2011	Suzuki .....	D13/180
D635,527	S	4/2011	Hussell et al.	
7,923,739	B2	4/2011	Hussell	
D641,719	S	7/2011	Hussell et al.	
D643,819	S	8/2011	Joo	
D648,686	S	11/2011	Hussell et al.	
D648,687	S	11/2011	Joo et al.	
D658,599	S *	5/2012	Takahashi et al. ....	D13/180
D659,657	S	5/2012	Hussell et al.	
D661,264	S	6/2012	Joo et al.	
8,269,244	B2	9/2012	Hussell	
2001/0045640	A1	11/2001	Oida et al.	
2002/0004251	A1	1/2002	Roberts et al.	
2004/0075100	A1	4/2004	Bogner et al.	
2004/0079957	A1	4/2004	Andrews et al.	
2004/0126913	A1	7/2004	Loh	
2006/0118808	A1	6/2006	Ishidu et al.	
2006/0157726	A1	7/2006	Loh et al.	
2006/0186418	A1	8/2006	Edmond et al.	
2006/0220050	A1	10/2006	Higaki et al.	
2007/0052074	A1	3/2007	Hasegawa	
2007/0057364	A1	3/2007	Wang et al.	
2007/0075325	A1	4/2007	Baek et al.	
2007/0114514	A1	5/2007	Ito	
2008/0006837	A1	1/2008	Park et al.	
2008/0023722	A1	1/2008	Lee et al.	
2008/0185605	A1	8/2008	Wada et al.	
2008/0258130	A1	10/2008	Bergmann et al.	
2008/0258162	A1	10/2008	Koung et al.	
2008/0278941	A1	11/2008	Logan et al.	
2008/0290353	A1	11/2008	Medendorp et al.	
2009/0008662	A1	1/2009	Ashdown et al.	
2009/0101921	A1	4/2009	Lai	
2009/0159905	A1	6/2009	Chen	
2009/0189178	A1	7/2009	Kim et al.	
2009/0267085	A1	10/2009	Lee et al.	
2009/0321779	A1	12/2009	Kim et al.	
2010/0059783	A1	3/2010	Chandra	
2010/0102345	A1	4/2010	Kong et al.	
2010/0133554	A1	6/2010	Hussell	
2010/0133578	A1	6/2010	Pickard et al.	
2010/0155748	A1	6/2010	Chan et al.	
2010/0163887	A1	7/2010	Kim et al.	
2010/0181582	A1	7/2010	Li et al.	
2010/0270577	A1	10/2010	Rulkens et al.	

2011/0006658	A1	1/2011	Chan
2011/0031865	A1	2/2011	Hussell et al.
2011/0180827	A1	7/2011	Hussell
2011/0186873	A1	8/2011	Emerson
2012/0127720	A1	5/2012	Hussell et al.
2012/0153317	A1	6/2012	Emerson et al.

## FOREIGN PATENT DOCUMENTS

EM	001242234	1/2011
JP	D1102760	3/2001
JP	2005-179147	7/2005
JP	2005-209763	8/2005
JP	2007-108547	4/2007
JP	2008-091792	4/2008
JP	2008-103480	5/2008
JP	2008-545269	12/2008
JP	D1346959	12/2008
JP	2010-034262	2/2010
JP	2010-205776	9/2010
JP	1416396	5/2011
JP	1431637	12/2011
JP	1433335	1/2012
JP	1441805	4/2012
KR	1020070000130 A	1/2007
KR	10-0845856	7/2008
KR	1020090003378 A	1/2009
TW	100305347	3/2012
WO	WO 2007/126720	11/2007
WO	WO 2008/021268	2/2008
WO	WO 2012/005984	1/2012
WO	WO 2012/021238	2/2012
WO	WO 2012/050994	4/2012
WO	WO 2012/100060	7/2012
WO	WO 2012/106312	8/2012
WO	WO 2012/109225	8/2012

## OTHER PUBLICATIONS

Supplemental Notice of Allowability for U.S. Appl. No. 12/479,318 dated Apr. 5, 2011.

Notice of Allowance for U.S. Appl. No. 29/360,791 dated Apr. 12, 2011.

Notice of Allowance for U.S. Appl. No. 29/365,939 dated Apr. 12, 2011.

Supplemental Notice of Allowance for U.S. Appl. No. 29/338,186 dated May 20, 2011.

Description Model No. NS6G083 issued by Nichia Corporation—at least as early as Aug. 31, 2007.

Description Model No. NS6x083x issued by Nichia Corporation—at least as early as Feb. 17, 2007.

U.S. Appl. No. 29/338,186, filed Jun. 5, 2009.

Co-pending U.S. Appl. No. 12/498,856, filed Jul. 7, 2009.

Notice of Allowance from U.S. Appl. No. 29/330,657 dated Sep. 25, 2009.

U.S. Appl. No. 29/353,652, filed Jan. 12, 2010.

Notice of Allowance from U.S. Appl. No. 29/338,186 dated Apr. 16, 2010.

U.S. Appl. No. 29/360,791, filed Apr. 30, 2010.

Non-Final Office Action for U.S. Appl. No. 12/479,318 dated Jun. 2, 2010.

Related U.S. Appl. No. 29/365,939, filed Jul. 16, 2010.

U.S. Appl. No. 12/853,812, filed Aug. 10, 2010.

Notice of Allowance for U.S. Appl. No. 29/353,652 dated Aug. 24, 2010.

U.S. Appl. No. 61/404,985, filed Oct. 13, 2010.

Non-final Office Action for U.S. Appl. No. 12/479,318 dated Nov. 10, 2010.

Notice of Allowance for U.S. Appl. No. 29/353,652 dated Nov. 26, 2010.

Supplemental Notice of Allowance for U.S. Appl. No. 29/353,652 dated Dec. 8, 2010.

Related CIP U.S. Appl. No. 12/969,267, filed Dec. 15, 2010 (Filed With Non-publication Request).

Notice of Allowance for U.S. Appl. No. 29/360,791 dated Dec. 22, 2010.



- Notice of Allowance for U.S. Appl. No. 29/365,939 dated Dec. 27, 2010.
- Related U.S. Appl. No. 29/382,394, filed Jan. 3, 2011.
- International Search Report/Written Opinion dated Jan. 5, 2011 for PCT/US2010/035379.
- U.S. Appl. No. 13/011,609, filed Jan. 21, 2011.
- Supplemental Notice of Allowance for U.S. Appl. No. 29/360,791 dated Jan. 24, 2011.
- Notice of Allowance for U.S. Appl. No. 12/479,318 dated Feb. 17, 2011.
- Notice of Allowance for U.S. Appl. No. 29/338,186 dated Mar. 10, 2011.
- Certificate of Registration for Community Design Application Serial No. 001283600-0001-0003 dated Jan. 7, 2011.
- Japanese Office Action for JP2010-026185 dated Apr. 5, 2011.
- Taiwanese Office Action for Appl. No. 099305566 dated Jul. 12, 2011.
- Notice of Allowance for U.S. Appl. No. 29/360,791 dated Jul. 21, 2011.
- Notice of Allowance for U.S. Appl. No. 29/380,549 dated Jul. 28, 2011.
- Office Action with Restriction/Election Requirement for U.S. Appl. No. 12/853,812 dated Sep. 22, 2011.
- International Search Report and Written Opinion for PCT Application Serial No. PCT/US2011/41833 dated Oct. 24, 2011.
- International Search Report and Written Opinion for PCT Application Serial No. PCT/US2011/043539 dated Oct. 28, 2011.
- Notice of Allowance for Japanese Application Serial No. JP-DES 2011/015199 dated Nov. 10, 2011.
- Notice of Allowance for Japanese Application Serial No. JP-DES 2011/015200 dated Nov. 30, 2011.
- Notice of Allowance for Japanese Application Serial No. JP-DES 2011/015201 dated Nov. 30, 2011.
- Notice of Allowance for Taiwanese Application Serial No. TW 099305566 dated Dec. 5, 2011.
- Notice of Allowance for Chinese Application Serial No. CN 2011/30171313.0 dated Dec. 6, 2011.
- Non-Final Office Action for U.S. Appl. No. 12/853,812 dated Dec. 7, 2011.
- International Preliminary Report on Patentability for PCT Application Serial No. PCT/US2010/035379 dated Dec. 8, 2011.
- Notice of Allowance for U.S. Appl. No. 29/397,017 dated Dec. 9, 2011.
- Non-Final Office Action for Korean Application Serial No. KR 30/2010-0047048 dated Dec. 15, 2011.
- Non-Final Office Action for Korean Application Serial No. KR 30/2010-0047049 dated Dec. 15, 2011.
- Notification of Grant for Chinese Application Serial No. CN 2011/30210595.0 dated Jan. 17, 2012.
- Notification of Grant for Chinese Application Serial No. CN 2010-305787293.2 dated Jan. 19, 2012.
- Notice of Allowance for U.S. Appl. No. 29/401,692 dated Jan. 20, 2012.
- Notice of Allowance for U.S. Appl. No. 29/403,433 dated Feb. 2, 2012.
- International Search Report for Application Serial No. TW 100305347 dated Mar. 5, 2012.
- Japanese Notice of Allowance for Application Serial No. JP 2011-017747 dated Mar. 13, 2012.
- Communication of European publication number and information on the application of Article 67(3) EPC dated Mar. 14, 2012.
- Non-Final Office Action for U.S. Appl. No. 13/082,699 dated Apr. 13, 2012.
- Notice of Allowance for U.S. Appl. No. 29/397,017 dated May 17, 2012.
- Notice of Allowance for U.S. Appl. No. 12/853,812 dated May 21, 2012.
- International Search Report and Written Opinion for Application Serial No. PCT/US2011/054560 dated May 22, 2012.
- Supplemental Notice of Allowance for U.S. Appl. No. 29/397,017 dated Jul. 23, 2012.
- Certificate of Design Patent for Application No. 2011/015199 dated Dec. 9, 2011.
- Certificate of Design Patent for Application No. 2011/015200 dated Jan. 6, 2012.
- Certificate of Design Patent for Application No. 2011/015201 dated Jan. 6, 2012.
- Notification of Publication for Serial No. PCT/US2012/024122 dated Aug. 16, 2012.
- Certificate of Design Patent for Chinese Application Serial No. CN ZL 201130171313 dated May 7, 2012.
- Certificate of Design Patent for Application Serial No. CN ZL 201130210595 dated Jun. 11, 2012.
- Certificate of Design Patent for Application Serial No. CN ZL 201030577293 dated Jun. 11, 2012.
- International Search Report for Application Serial No. PCT/US2012/023285 dated Jun. 27, 2012.
- International Search Report and Written Opinion for Application Serial No. PCT/US2012/024122 dated Jul. 11, 2012.
- Korean Office Action for Application Serial No. KR 30-2011-27243 dated Jul. 5, 2012.
- Korean Office Action for Application Serial No. KR 30-2011-27244 dated Jul. 5, 2012.
- Korean Office Action for Application Serial No. KR 30-2011-27245 dated Jul. 5, 2012.
- International Search Report and Written Opinion for Application Serial No. PCT/US2012/021879 dated Sep. 21, 2012.
- International Search Report and Written Opinion for Application Serial No. PCT/US2012/036110 dated Oct. 4, 2012.
- Notification of Publication for Serial No. PCT/US2012/023285 dated Aug. 9, 2012.
- Korean Office Action for Application Serial No. KR 30-2010-0047049 dated Sep. 12, 2012.
- Hyun-Ho Kim et al., Thermal Transient Characteristics of Die Attach in High Power LED PKG, *Microelectronics Reliability*, vol. 48, Issue 3, Mar. 2008, pp. 445-454.

\* cited by examiner

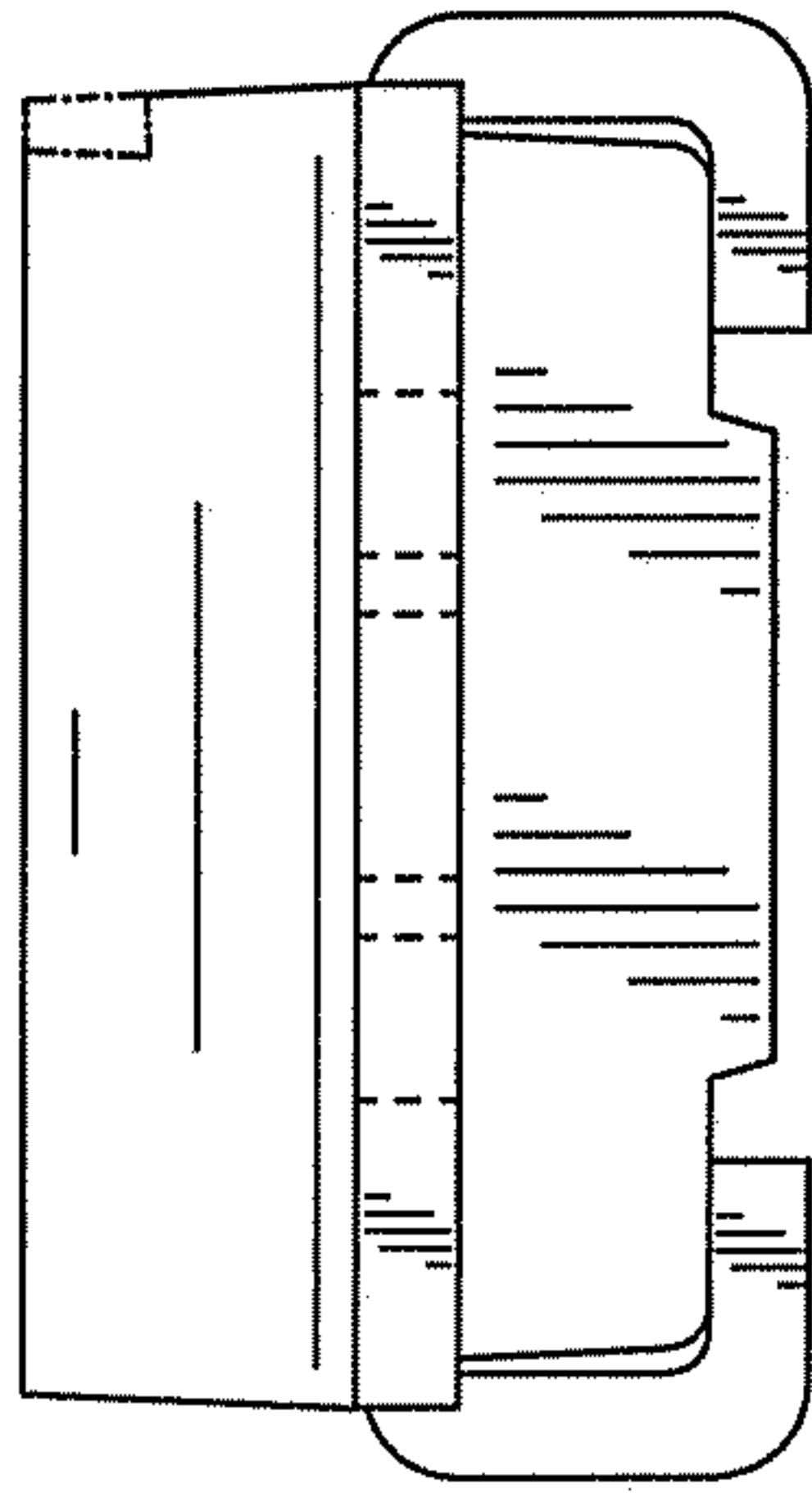

FIG. 4

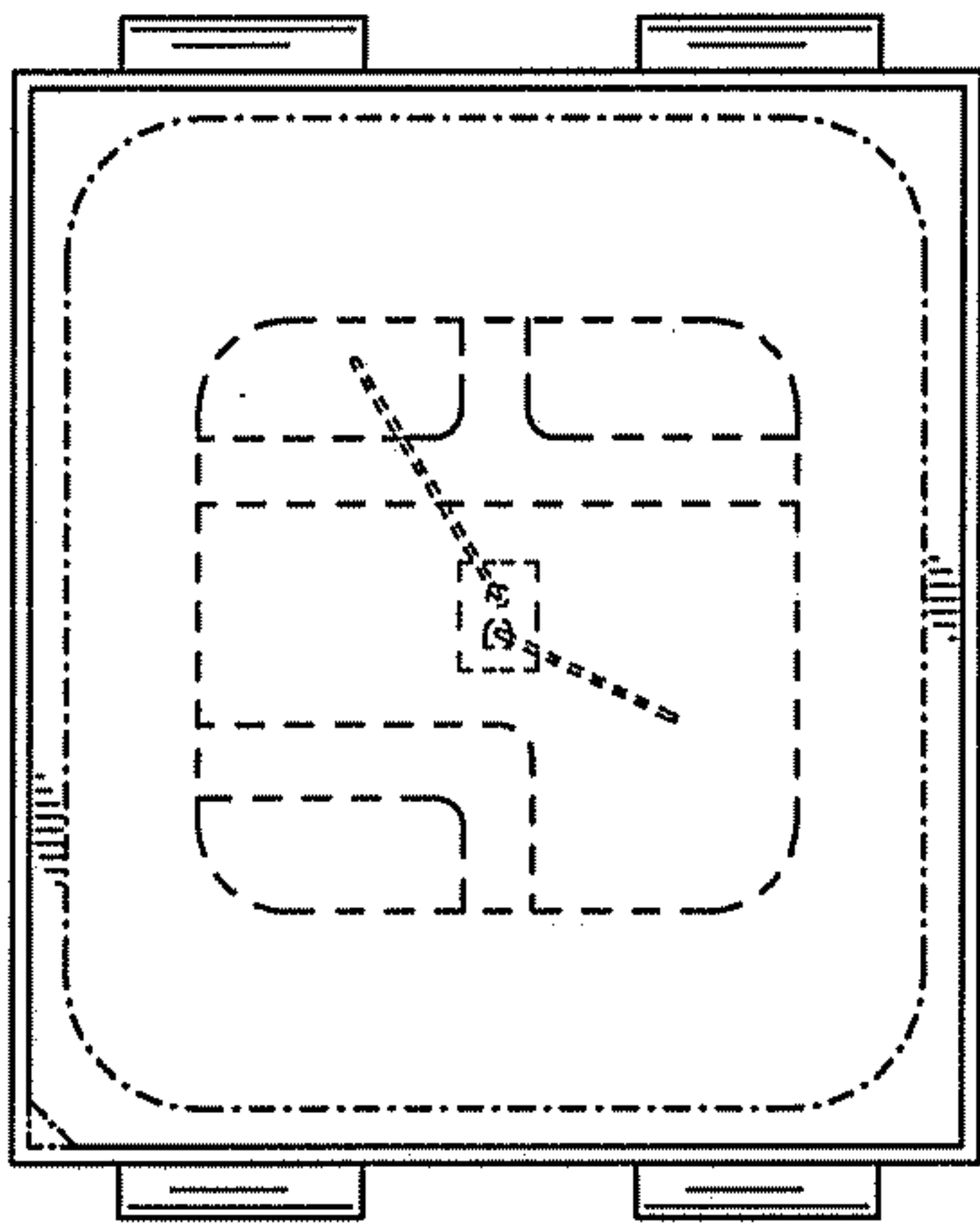

FIG. 3

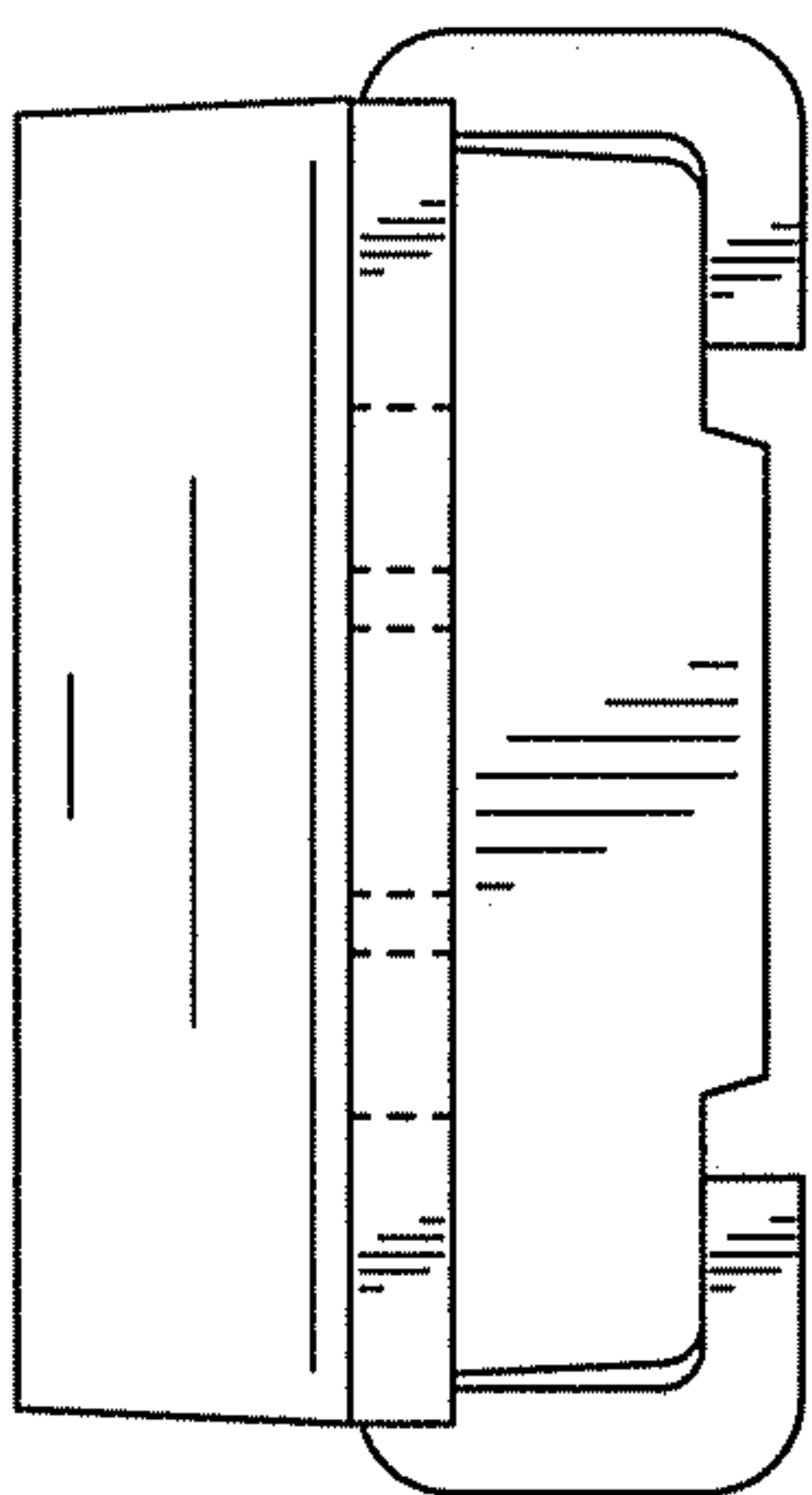

FIG. 2

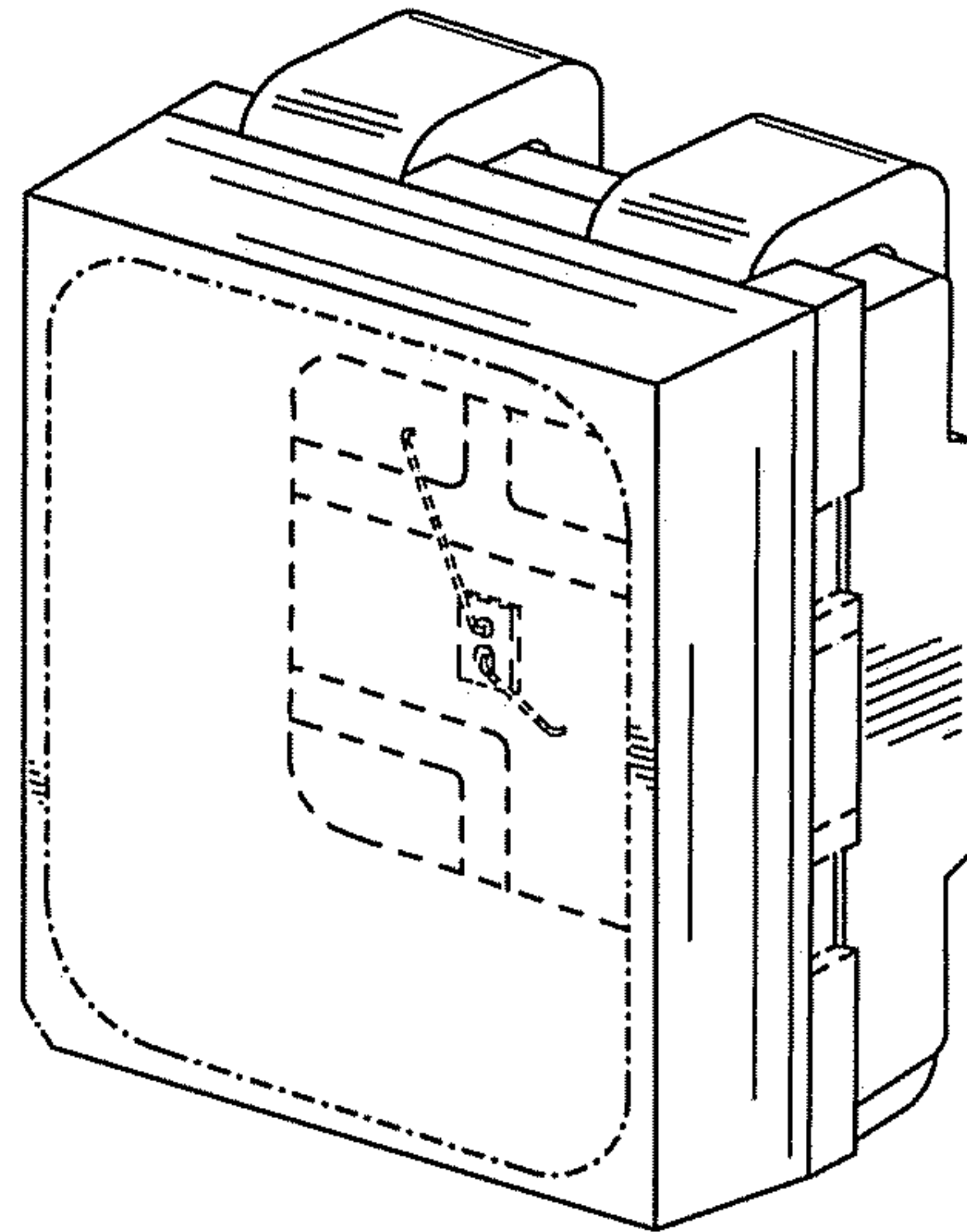

FIG. 1

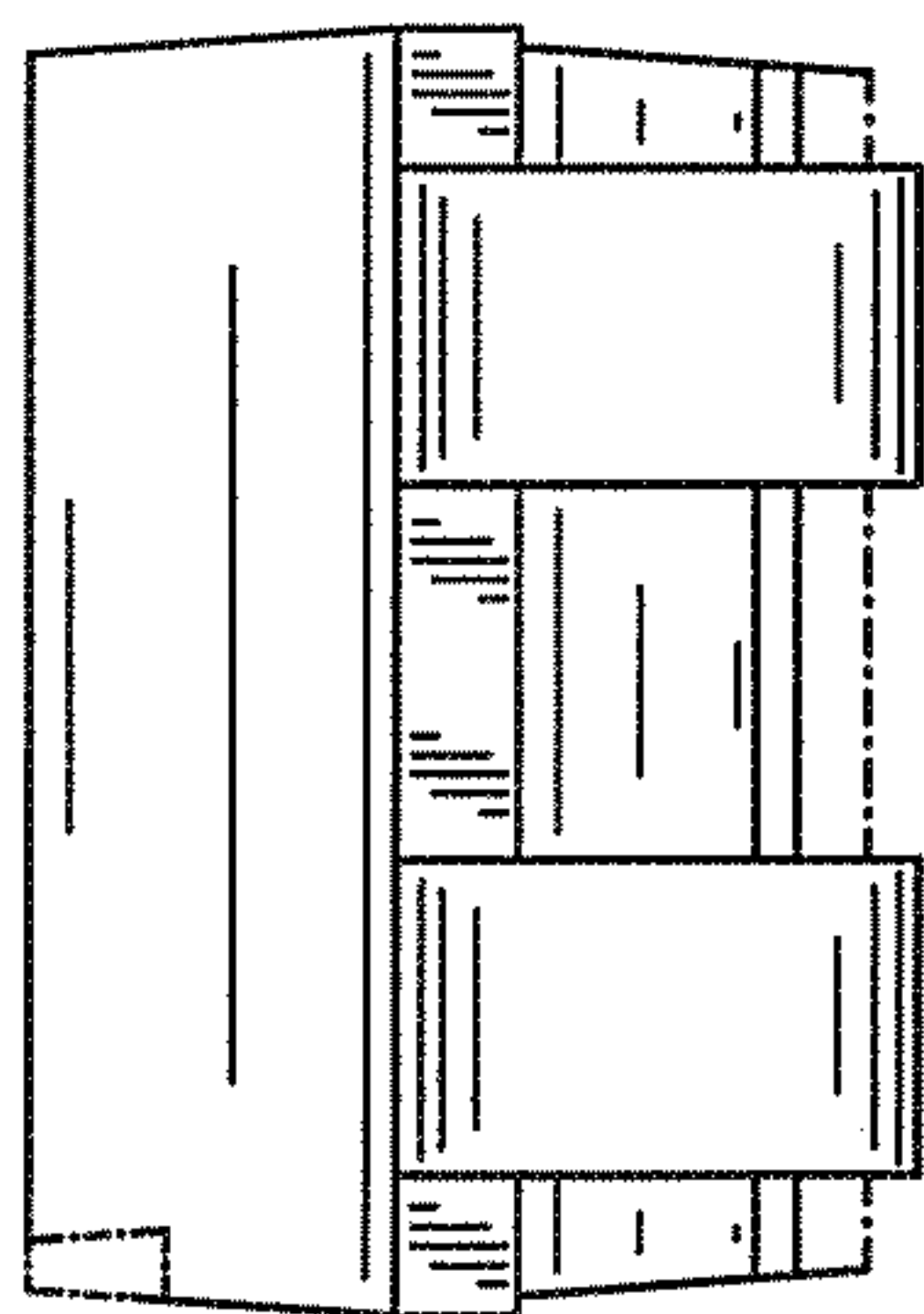

FIG. 7

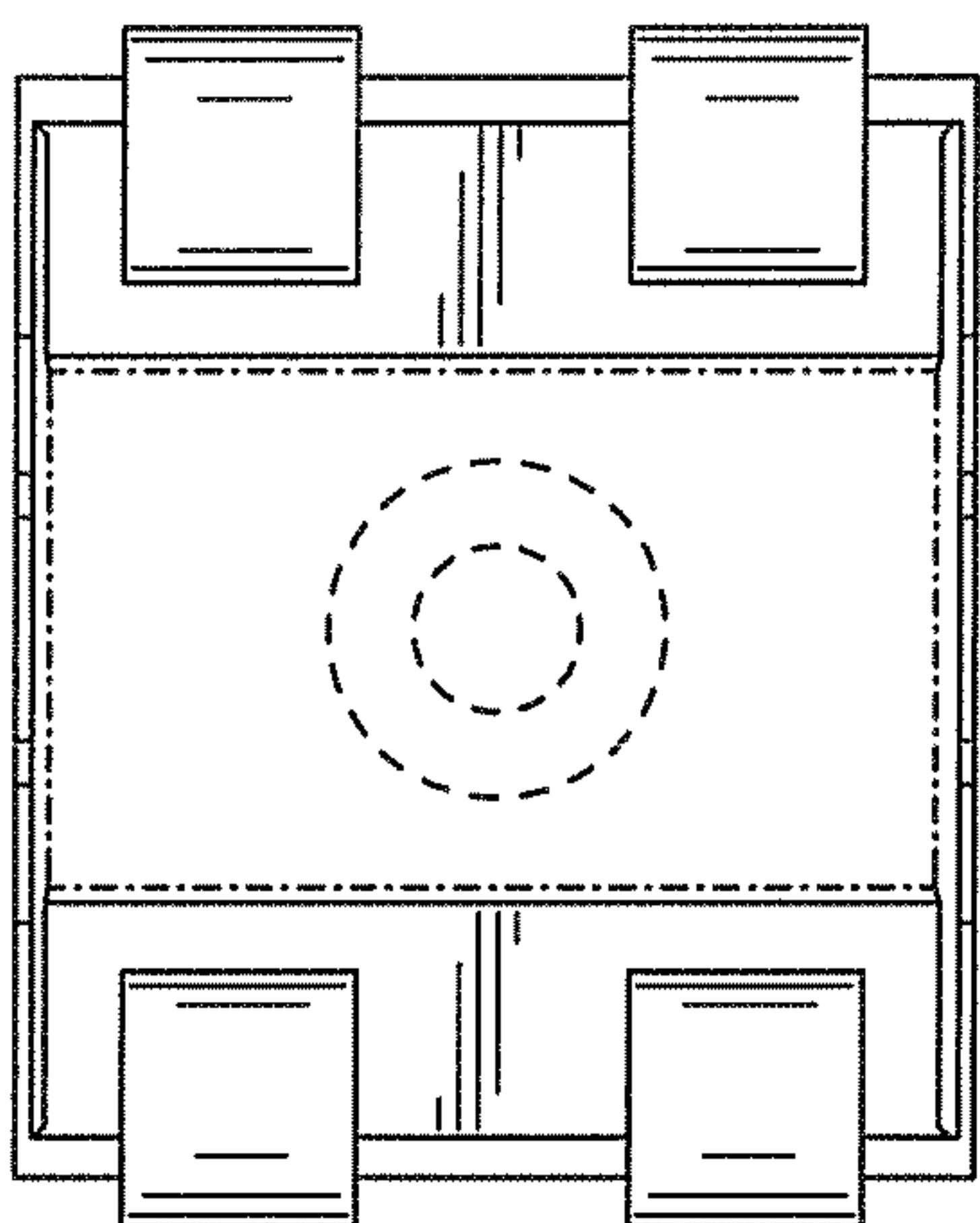

FIG. 5

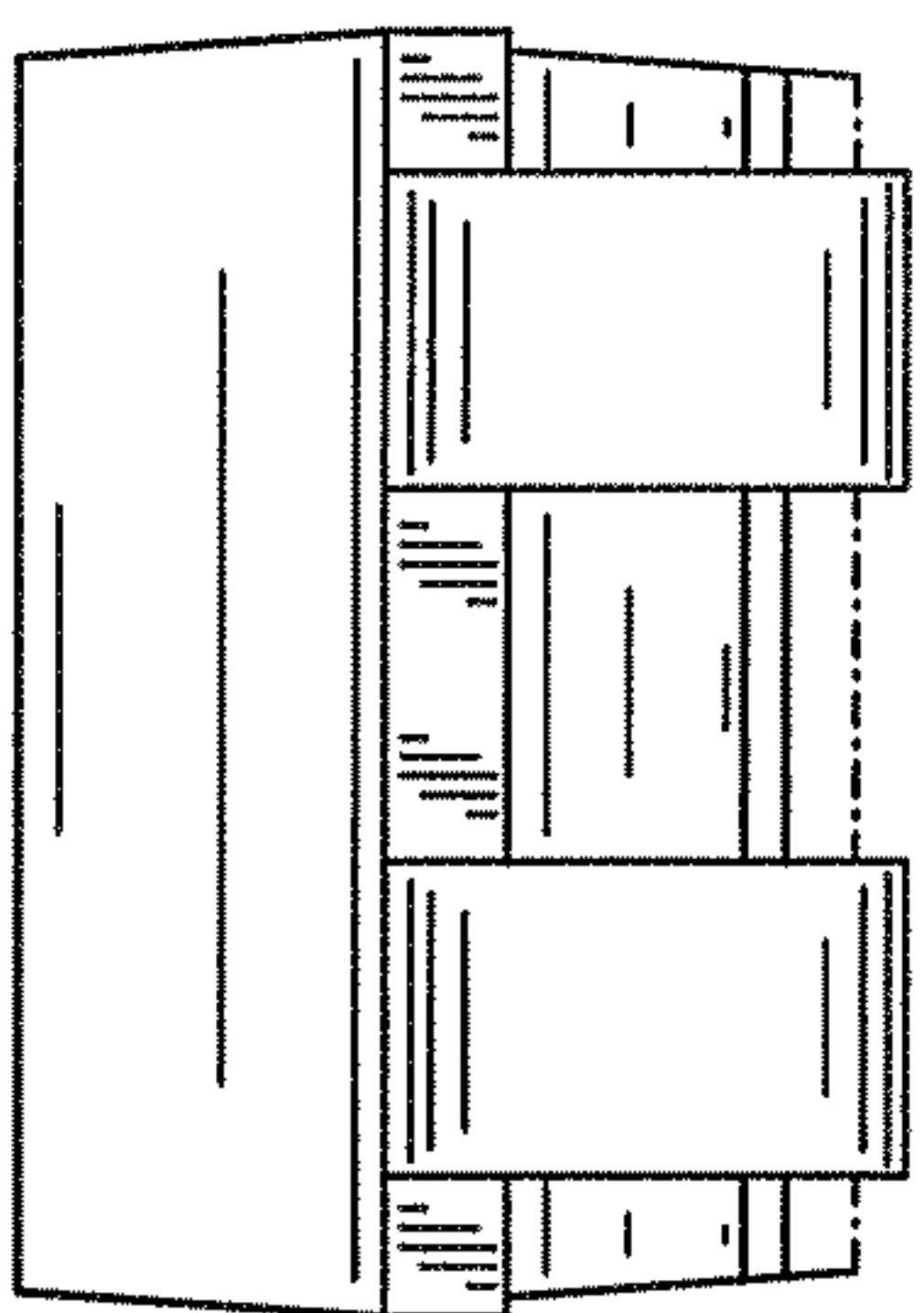

FIG. 6

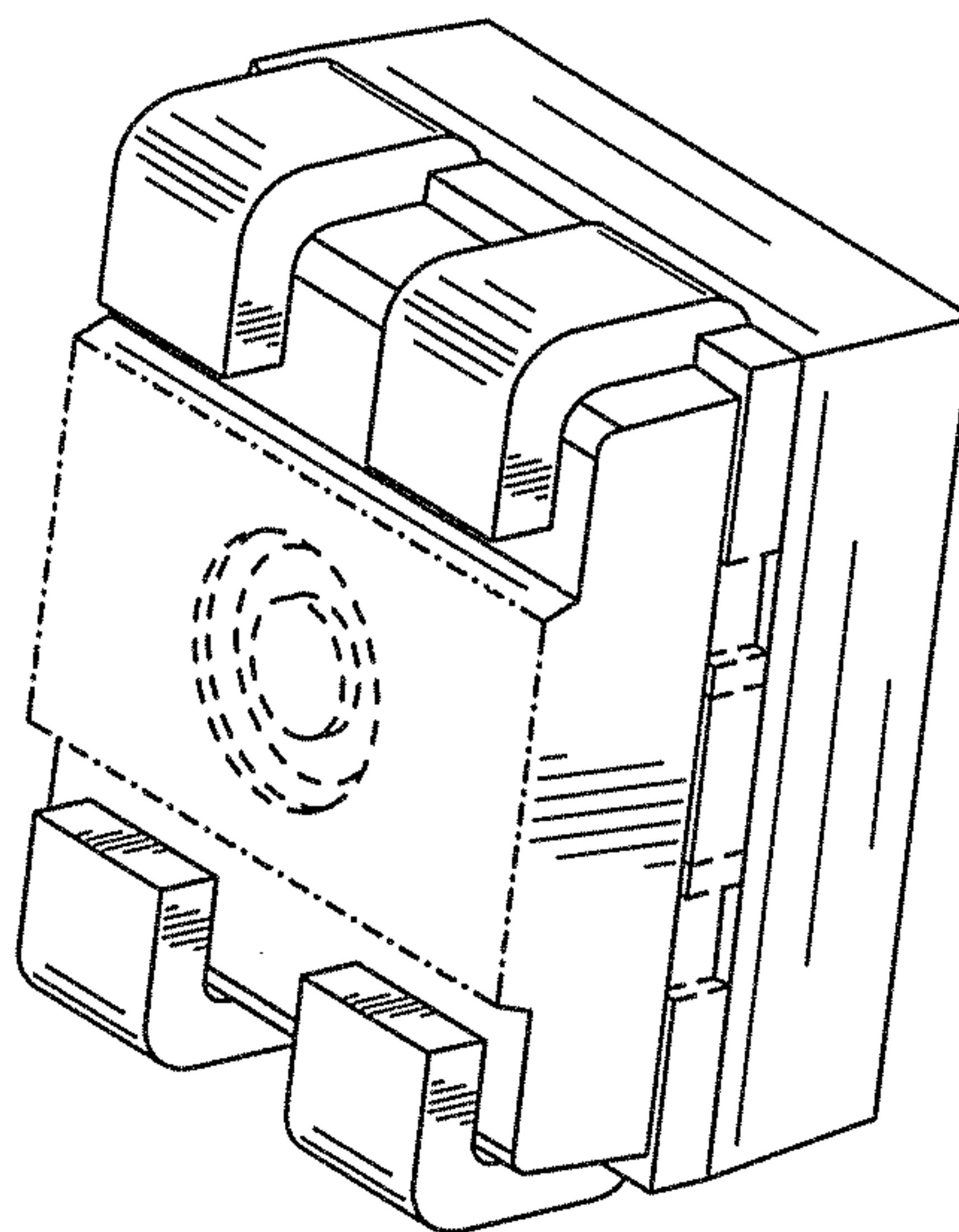

FIG. 8