

US00D679826S

(12) **United States Design Patent**  
**Ziegmann et al.**

(10) **Patent No.:** **US D679,826 S**

(45) **Date of Patent:** **\*\* \*Apr. 9, 2013**

(54) **FILTER PIPETTE TIP**

(75) Inventors: **Christian Ziegmann**, Ahrensburg (DE);  
**Thomas Reimann**, Geesthacht (DE)

(73) Assignee: **Eppendorf AG**, Hamburg (DE)

(\*) Notice: This patent is subject to a terminal disclaimer.

(\*\*) Term: **14 Years**

(21) Appl. No.: **29/251,514**

(22) Filed: **Jan. 9, 2006**

(30) **Foreign Application Priority Data**

Jul. 11, 2005 (EM) ..... 000370655

(51) **LOC (9) Cl.** ..... **24-02**

(52) **U.S. Cl.** ..... **D24/222**

(58) **Field of Classification Search** ..... D24/216–231;  
422/100–104; 73/863.32, 864.01, 864.02,  
73/864.11, 864.13, 864.14, 864.16; D10/81  
See application file for complete search history.

(56) **References Cited**

**U.S. PATENT DOCUMENTS**

D252,586	S *	8/1979	Kovach	.....	D24/222
D255,601	S *	6/1980	De Vaughn	.....	D24/222
D286,570	S *	11/1986	Williams	.....	D24/222
4,810,394	A *	3/1989	Masuda	.....	210/767
4,999,164	A *	3/1991	Puchinger et al.	.....	422/513
D357,324	S *	4/1995	Bartal	.....	D24/222
5,437,979	A *	8/1995	Rampal et al.	.....	435/6
5,496,523	A *	3/1996	Gazit et al.	.....	422/100
5,565,366	A *	10/1996	Akers, Jr.	.....	422/101
D384,418	S *	9/1997	Torti et al.	.....	D24/222
5,851,491	A *	12/1998	Moulton	.....	422/101
D405,521	S *	2/1999	Leight	.....	D24/106
6,045,757	A *	4/2000	Moriarty et al.	.....	422/100
6,140,758	A *	10/2000	Matsuda et al.	.....	313/466
D461,904	S *	8/2002	Petrek	.....	D24/222
D465,853	S *	11/2002	Petersen	.....	D24/222
6,482,362	B1 *	11/2002	Smith	.....	422/513
D468,439	S *	1/2003	On et al.	.....	D24/222

D468,440	S *	1/2003	Petrek	.....	D24/222
D468,830	S *	1/2003	On et al.	.....	D24/222
6,566,145	B2 *	5/2003	Brewer	.....	73/864.01
D487,593	S *	3/2004	Sarna	.....	D24/222
6,702,990	B1 *	3/2004	Camacho et al.	.....	73/864.01
6,770,246	B1	8/2004	Husek	.....	422/101
D499,771	S *	12/2004	Branton	.....	D21/333
2005/0023297	A1 *	2/2005	Zill et al.	.....	222/250
2005/0277203	A1 *	12/2005	Niskanen	.....	435/287.2

**FOREIGN PATENT DOCUMENTS**

DE	36 35 598	C2	5/1988
EP	1095706	A1	5/2001
EP	1095703	B1	1/2007
WO	WO 97/29846		8/1997

\* cited by examiner

*Primary Examiner* — Anhdao Doan

(74) *Attorney, Agent, or Firm* — Vidas, Arrett & Steinkraus

(57) **CLAIM**

The ornamental design for filter pipette tip, as shown and described.

**DESCRIPTION**

FIG. 1 is a perspective view of a first embodiment of a filter pipette tip showing our new design;  
 FIG. 2 is a front elevation view thereof;  
 FIG. 3 is a side elevation view thereof;  
 FIG. 4 is another side elevation view thereof;  
 FIG. 5 is a rear elevation view thereof;  
 FIG. 6 is a bottom plan view thereof;  
 FIG. 7 is a top plan view thereof;  
 FIG. 8 is a perspective view of a second embodiment of the filter pipette tip showing our new design;  
 FIG. 9 is a front elevation view thereof;  
 FIG. 10 is a side elevation view thereof;  
 FIG. 11 is another side elevation view thereof;  
 FIG. 12 is a rear elevation view thereof;  
 FIG. 13 is a bottom plan view thereof;  
 FIG. 14 is a top plan view thereof;  
 FIG. 15 is a perspective view of a third embodiment of the filter pipette tip showing our new design;  
 FIG. 16 is a front elevation view thereof;  
 FIG. 17 is a side elevation view thereof;

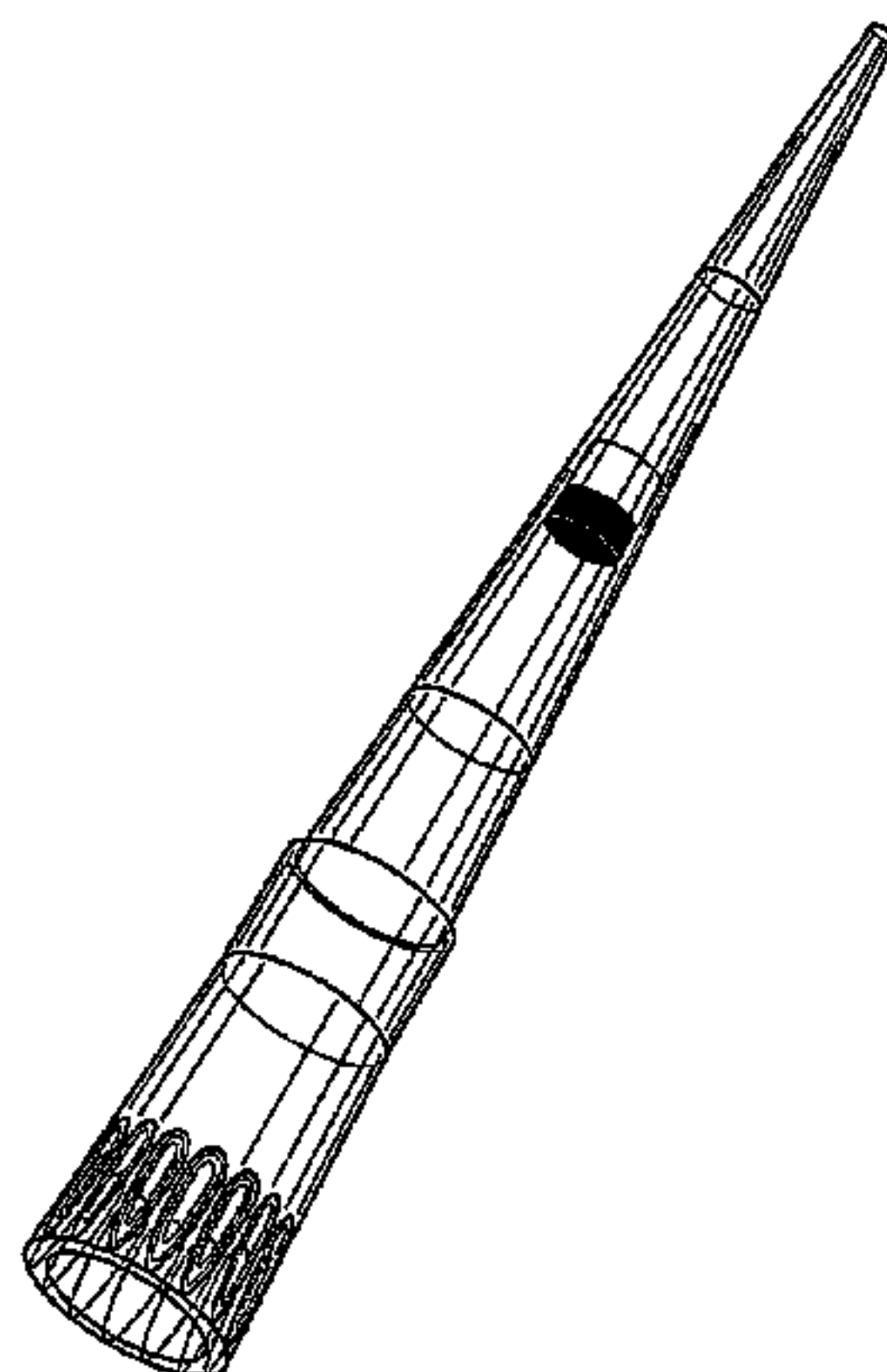

FIG. **18** is another side elevation view thereof;  
FIG. **19** is a rear elevation view thereof;  
FIG. **20** is a bottom plan view thereof;  
FIG. **21** is a top plan view thereof;  
FIG. **22** is a perspective view of a fourth embodiment of filter pipette tip showing our new design;  
FIG. **23** is a front elevation view thereof;  
FIG. **24** is a side elevation view thereof;  
FIG. **25** is another side elevation view thereof;

FIG. **26** is a rear elevation view thereof;  
FIG. **27** is a bottom plan view thereof; and,  
FIG. **28** is a top plan view thereof.  
The showing of solid black shading in the drawing views represents color contrast. The pipette tips include a transparent pipette tip and a bi-colored filter within the pipette tip and visible from the outside through the transparent tip.

**1 Claim, 12 Drawing Sheets**

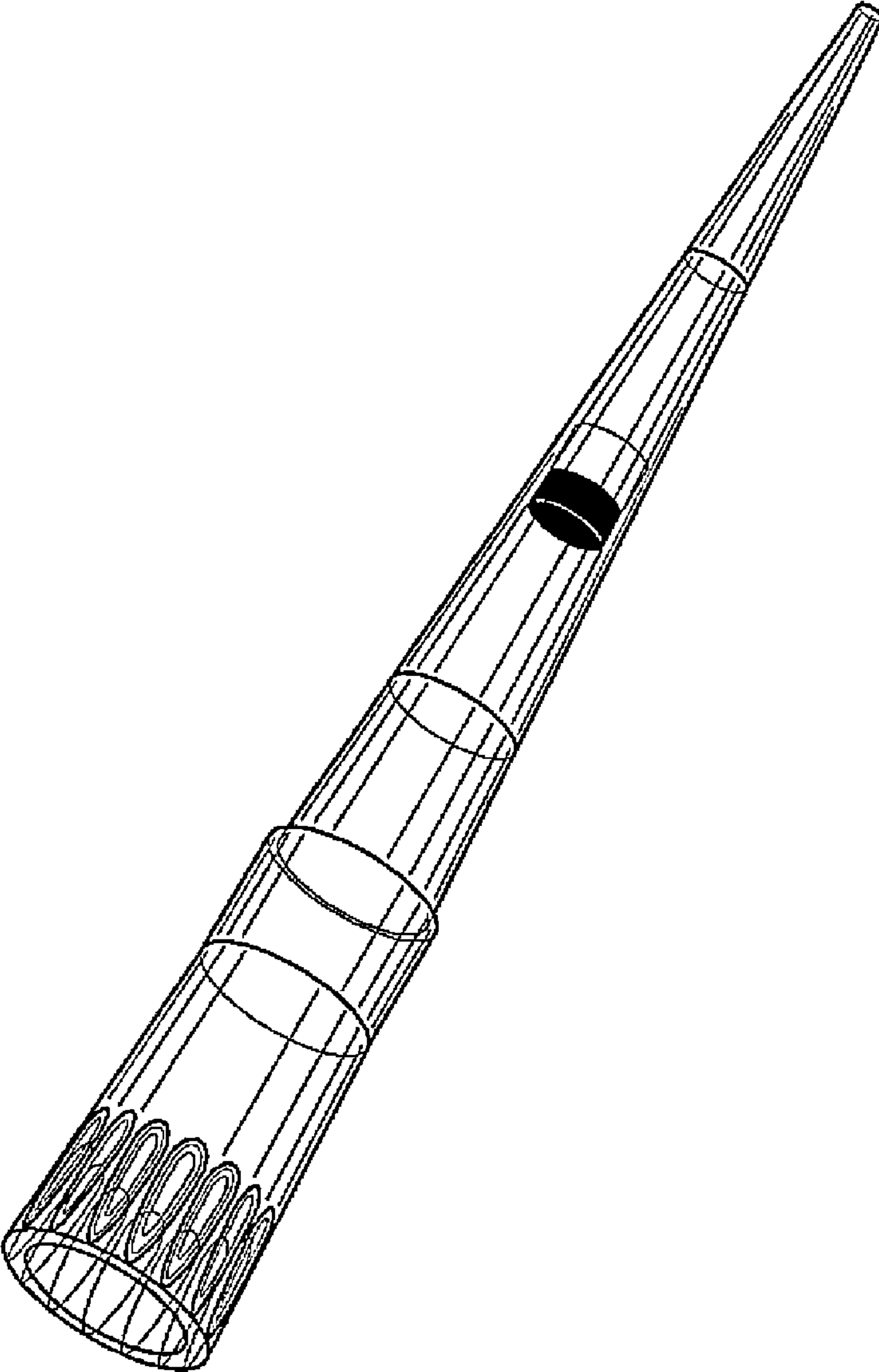

FIG. 1

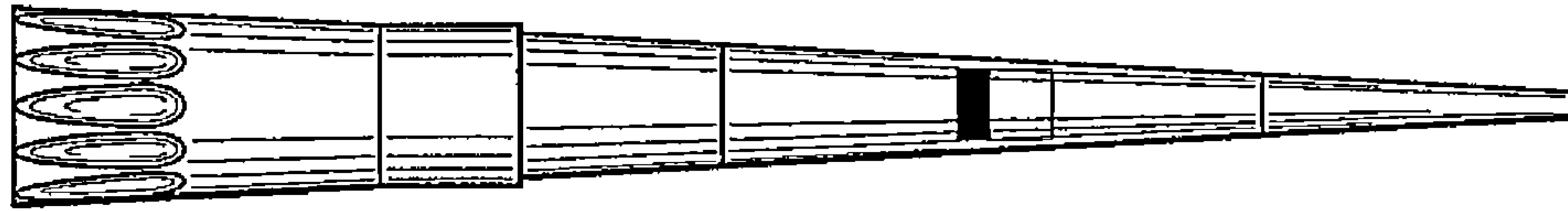

FIG. 2

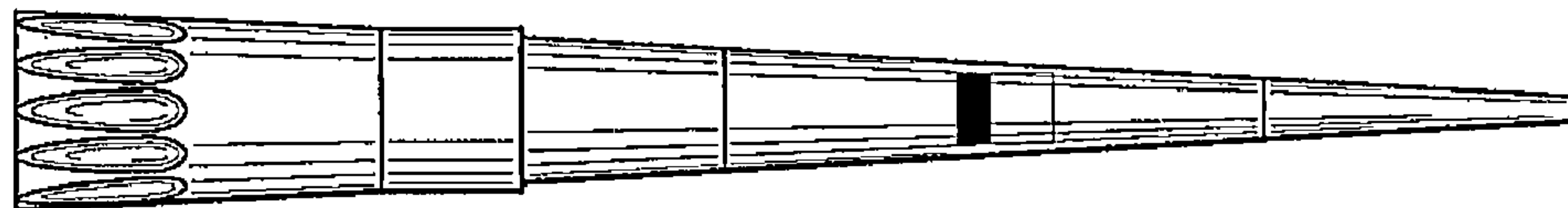

FIG. 3

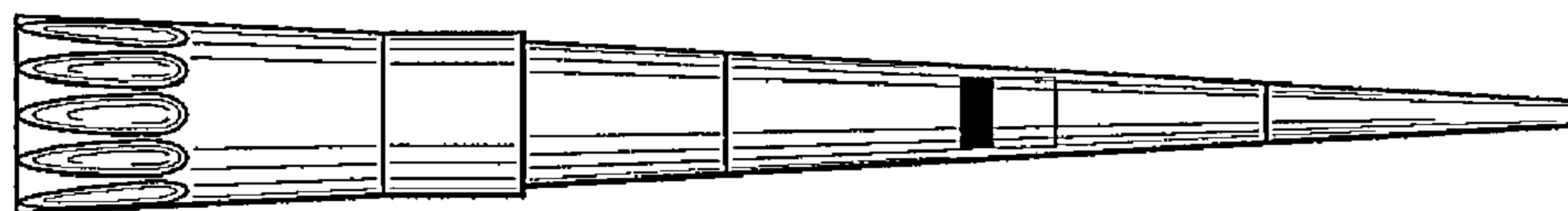

FIG. 4

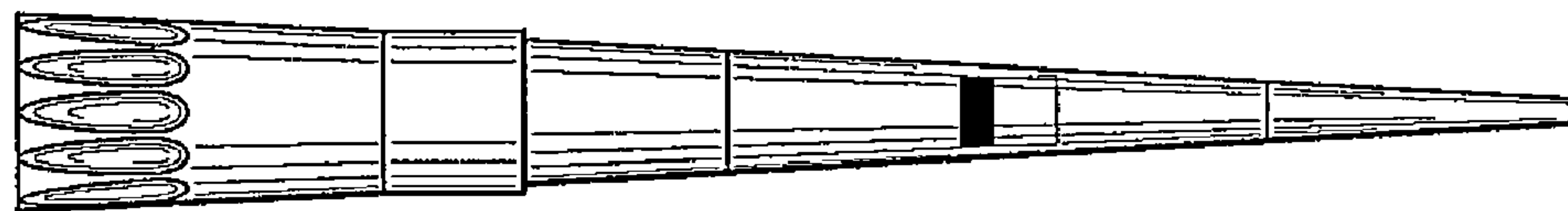

FIG. 5

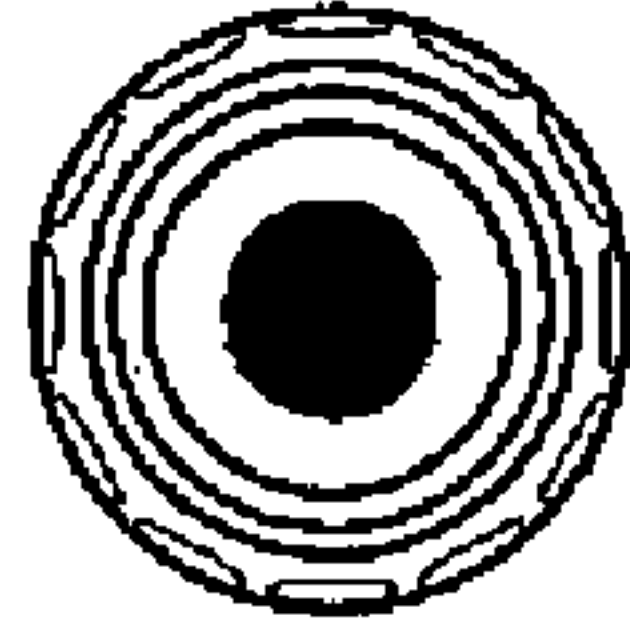

FIG. 6

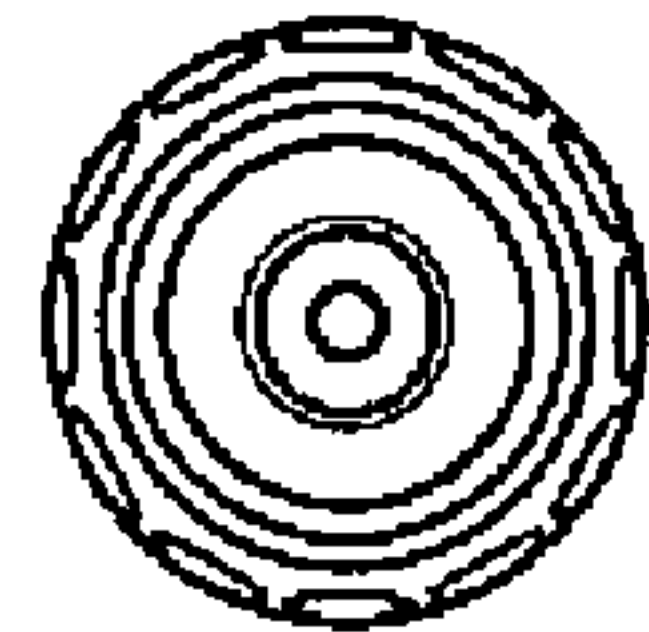

FIG. 7

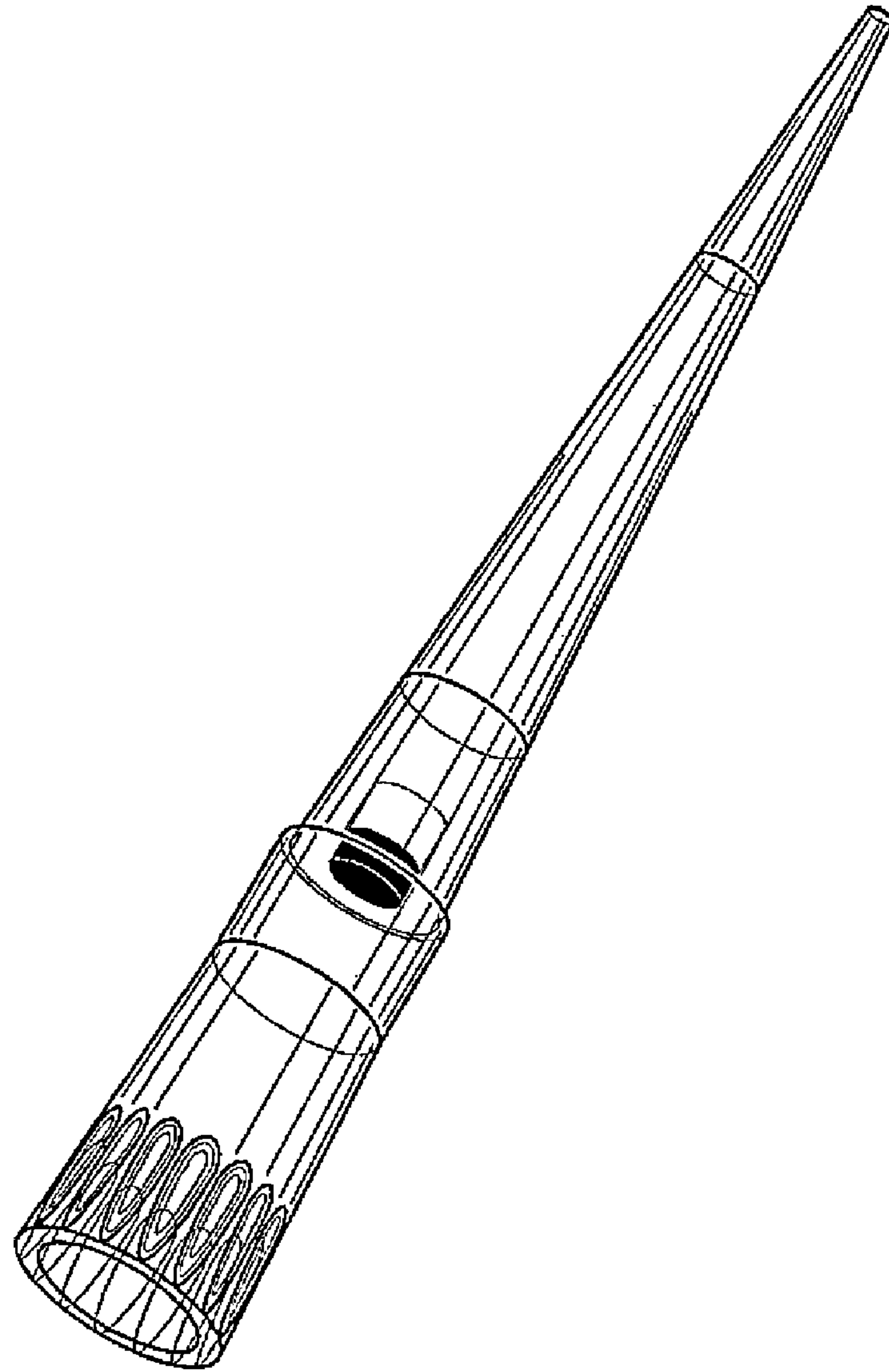

FIG. 8



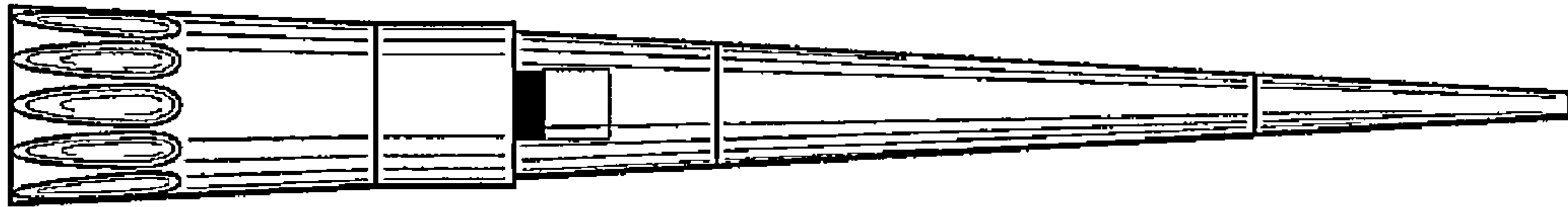

FIG. 9

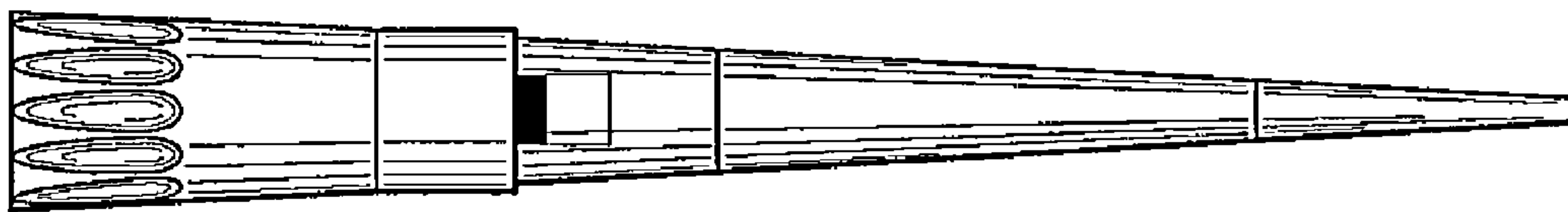

FIG. 10

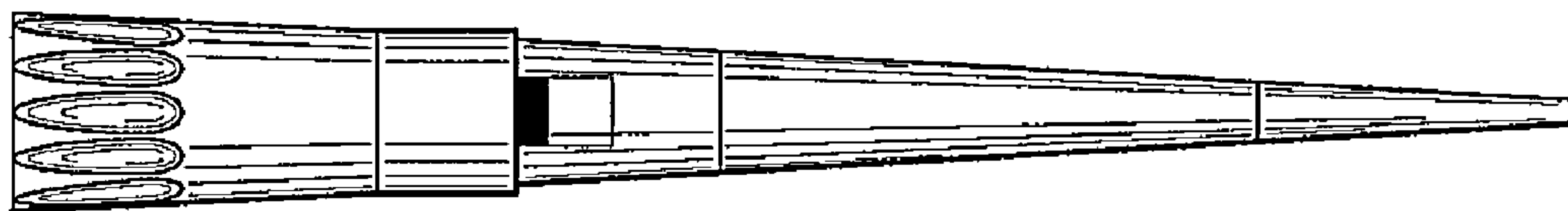

FIG. 11

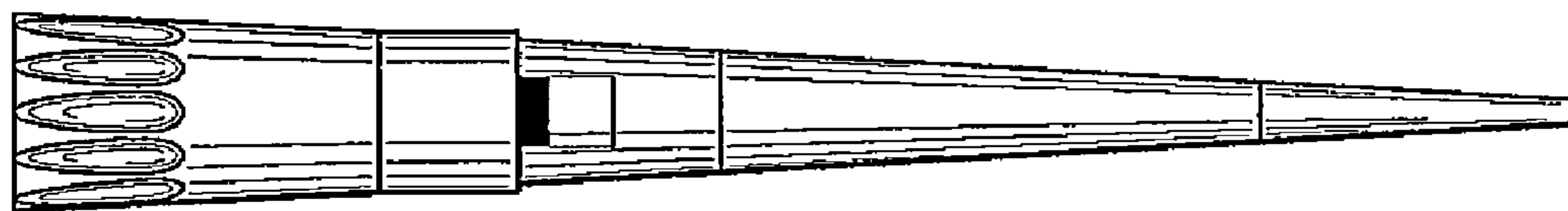

FIG. 12

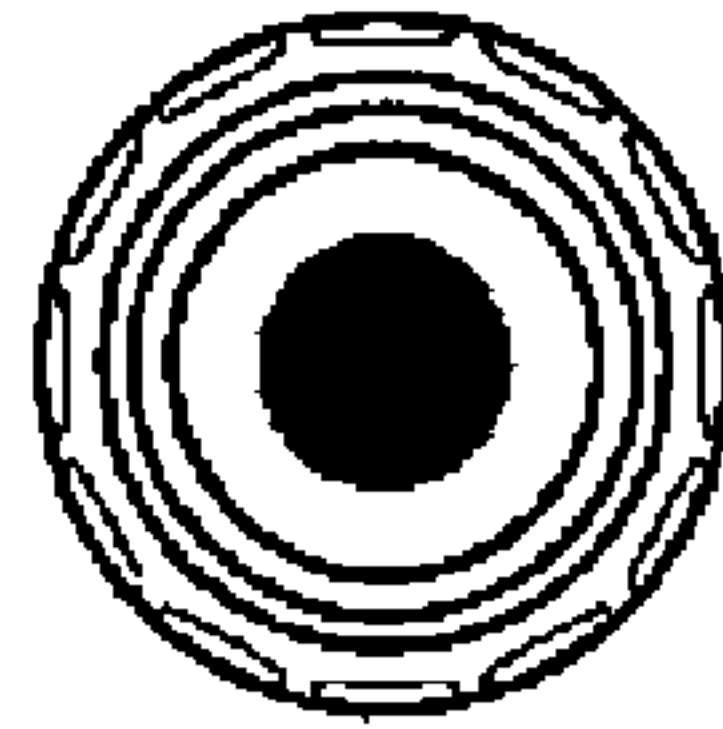

FIG. 13

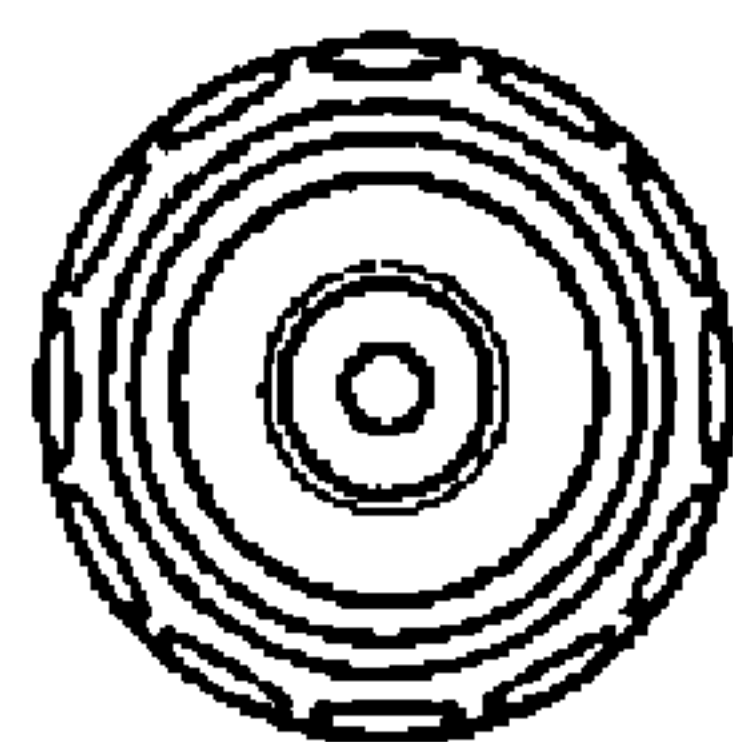

FIG. 14



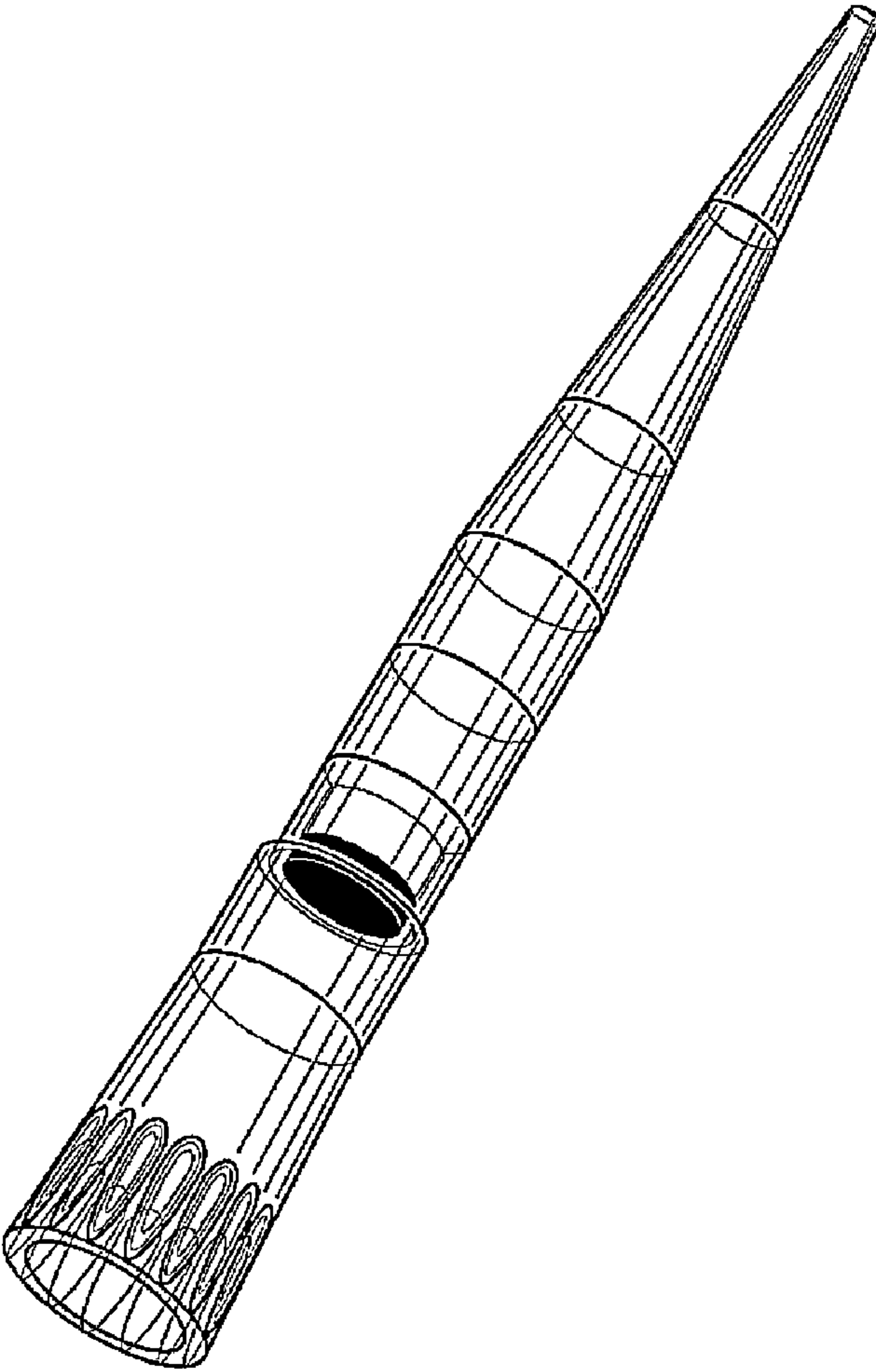

FIG. 15

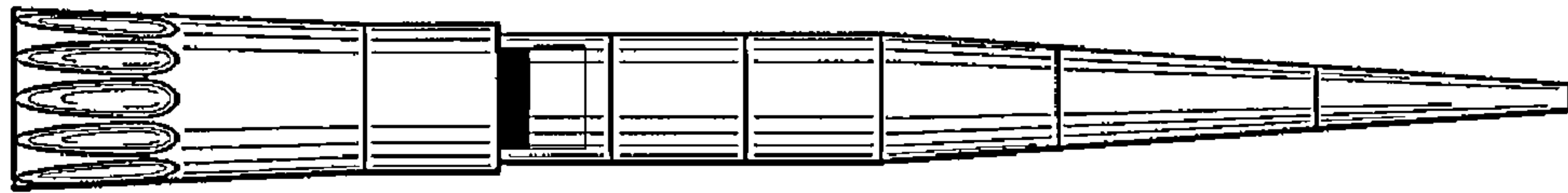

FIG. 16

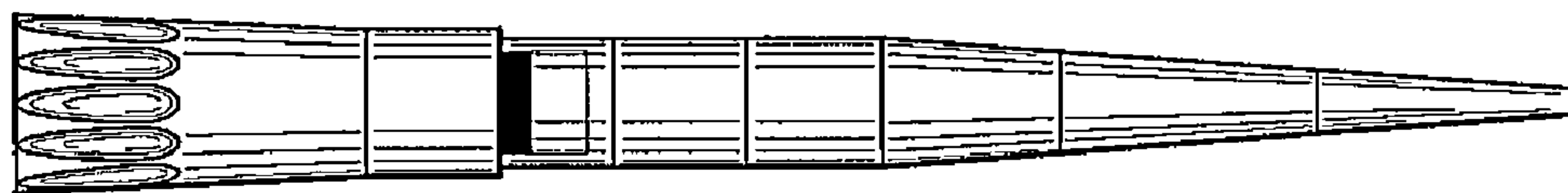

FIG. 17

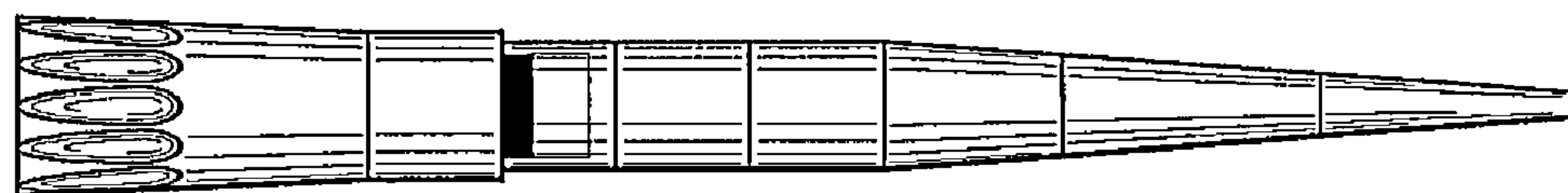

FIG. 18

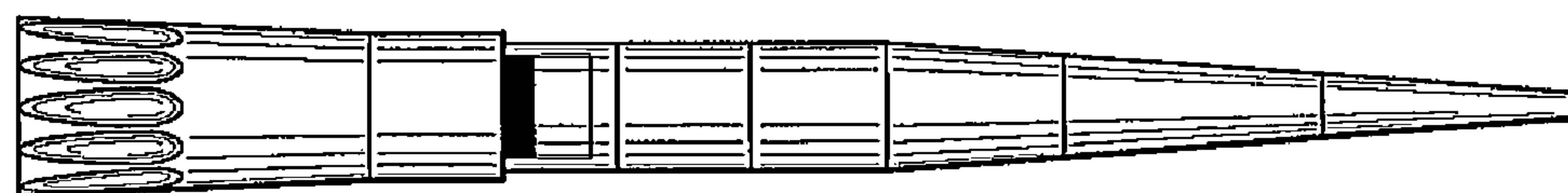

FIG. 19

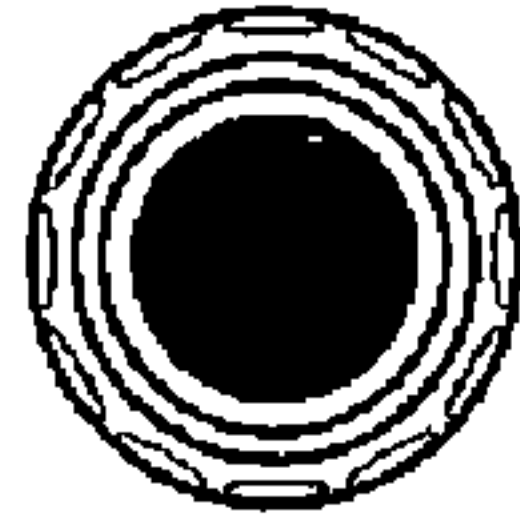

FIG. 20



FIG. 21

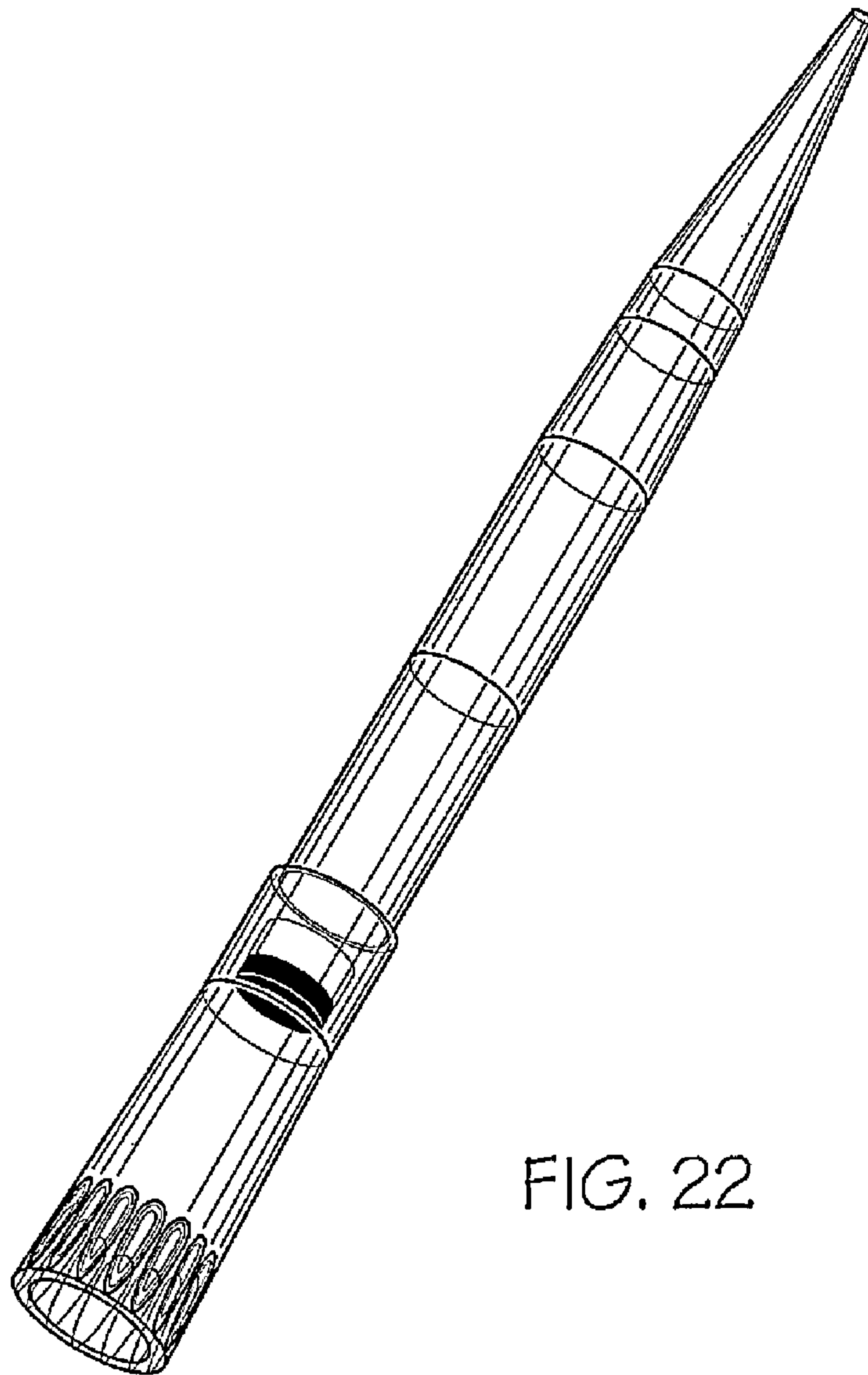

FIG. 22

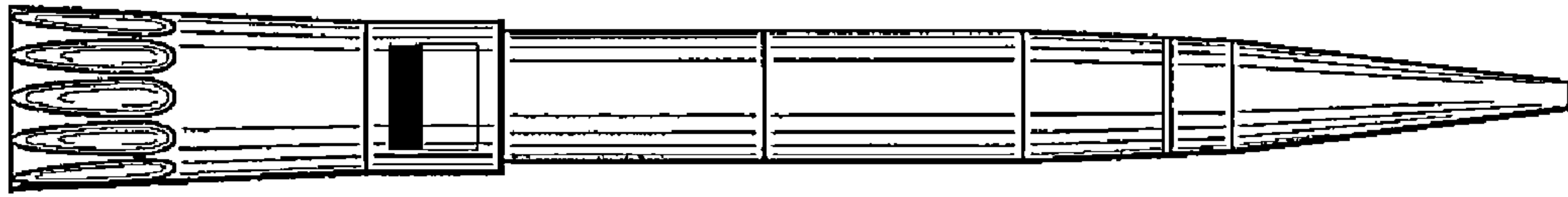

FIG. 23

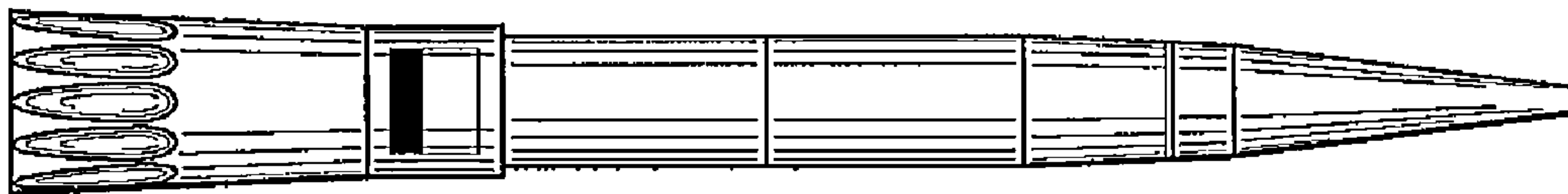

FIG. 24

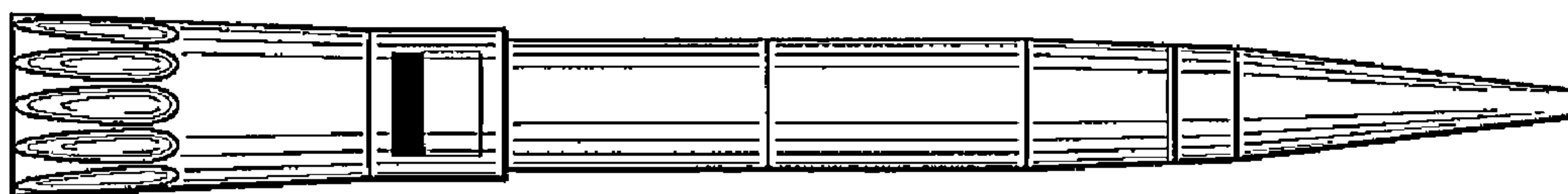

FIG. 25

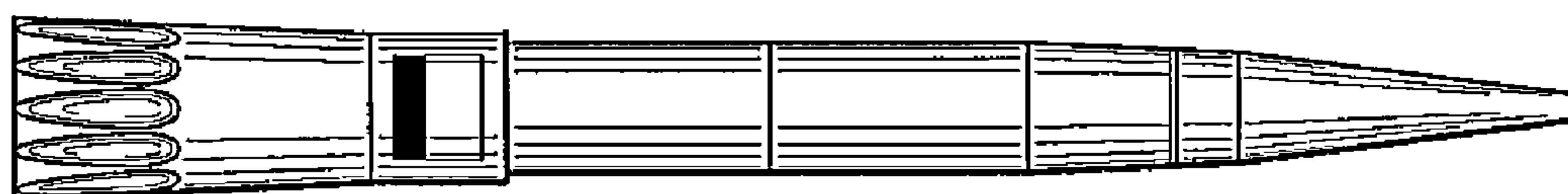

FIG. 26

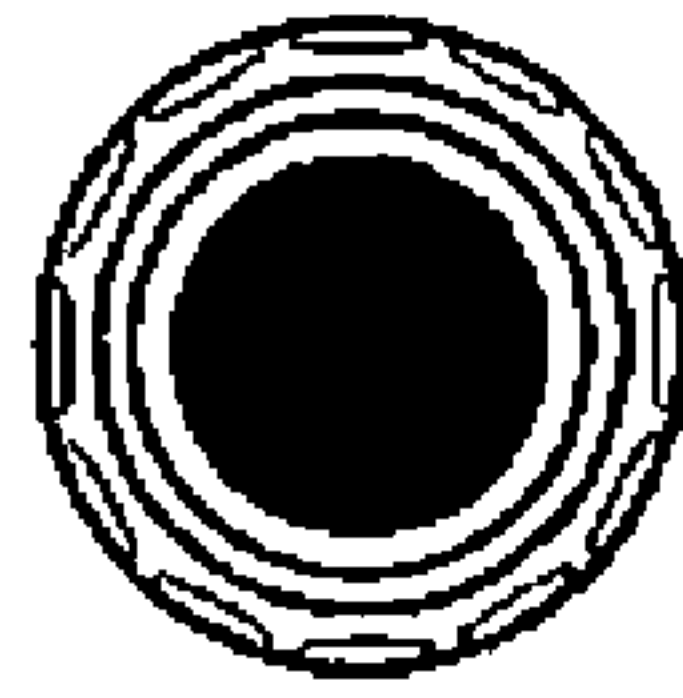

FIG. 27

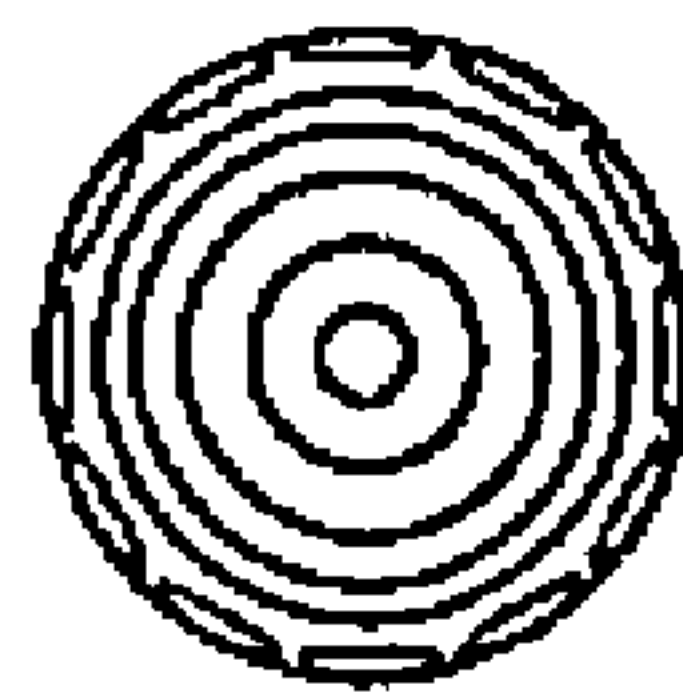

FIG. 28