



US00D679787S

(12) **United States Design Patent**
Lesage

(10) **Patent No.:** **US D679,787 S**

(45) **Date of Patent:** **** Apr. 9, 2013**

(54) **TANK WITH A TANKLESS WATER HEATER**

(75) Inventor: **Claude Lesage**, Pointe Claire (CA)

(73) Assignee: **Miclau-S.R.I. Inc.**, Montreal (CA)

(**) Term: **14 Years**

(21) Appl. No.: **29/425,256**

(22) Filed: **Jun. 21, 2012**

(30) **Foreign Application Priority Data**

Mar. 5, 2012 (CA) 144778

(51) **LOC (9) Cl.** **23-03**

(52) **U.S. Cl.** **D23/318**

(58) **Field of Classification Search** D23/314,
D23/332, 335-350, 378, 370, 381, 354, 351,
D23/386, 333, 328, 353, 361, 385, 417, 357,
D23/334, 355, 359, 362, 366, 320, 319, 318;
392/365, 367, 424, 383, 411, 360, 369, 373-376;
126/183, 110 B, 91 A, 92 A, 500, 544, 547

See application file for complete search history.

(56) **References Cited**

U.S. PATENT DOCUMENTS

D483,451 S	*	12/2003	Yamamoto et al.	D23/320
D483,844 S	*	12/2003	Yamamoto et al.	D23/320
D531,290 S	*	10/2006	Baumgartner	D23/319
D616,536 S	*	5/2010	Lee	D23/318
D644,307 S	*	8/2011	Chanasyk et al.	D23/318

* cited by examiner

Primary Examiner — T. Chase Nelson

Assistant Examiner — Ania Aman

(74) *Attorney, Agent, or Firm* — Norton Rose Canada LLP

(57) **CLAIM**

The ornamental design for a tank with a tankless water heater, as shown and described.

DESCRIPTION

FIG. 1 is a perspective view as shown from above the tank with a tankless water heater;
FIG. 2 is a front view thereof;
FIG. 3 is a side view thereof;
FIG. 4 is an opposed side view thereof;
FIG. 5 is a top view thereof; and,
FIG. 6 is a bottom view thereof.

The broken lines shown in the figures are included for the purpose of illustrating portions of the water heater that form no part of the claimed design.

1 Claim, 5 Drawing Sheets

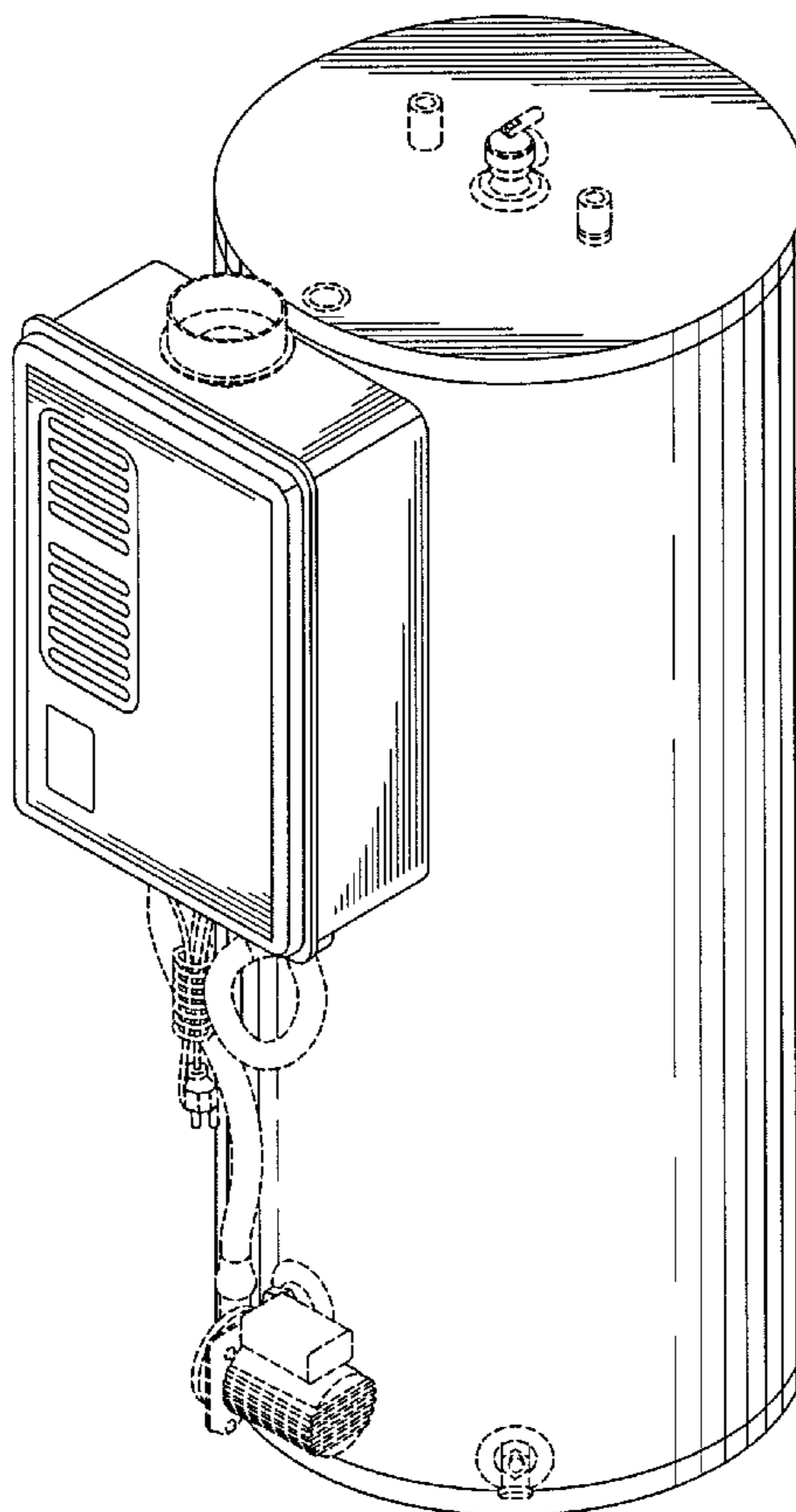

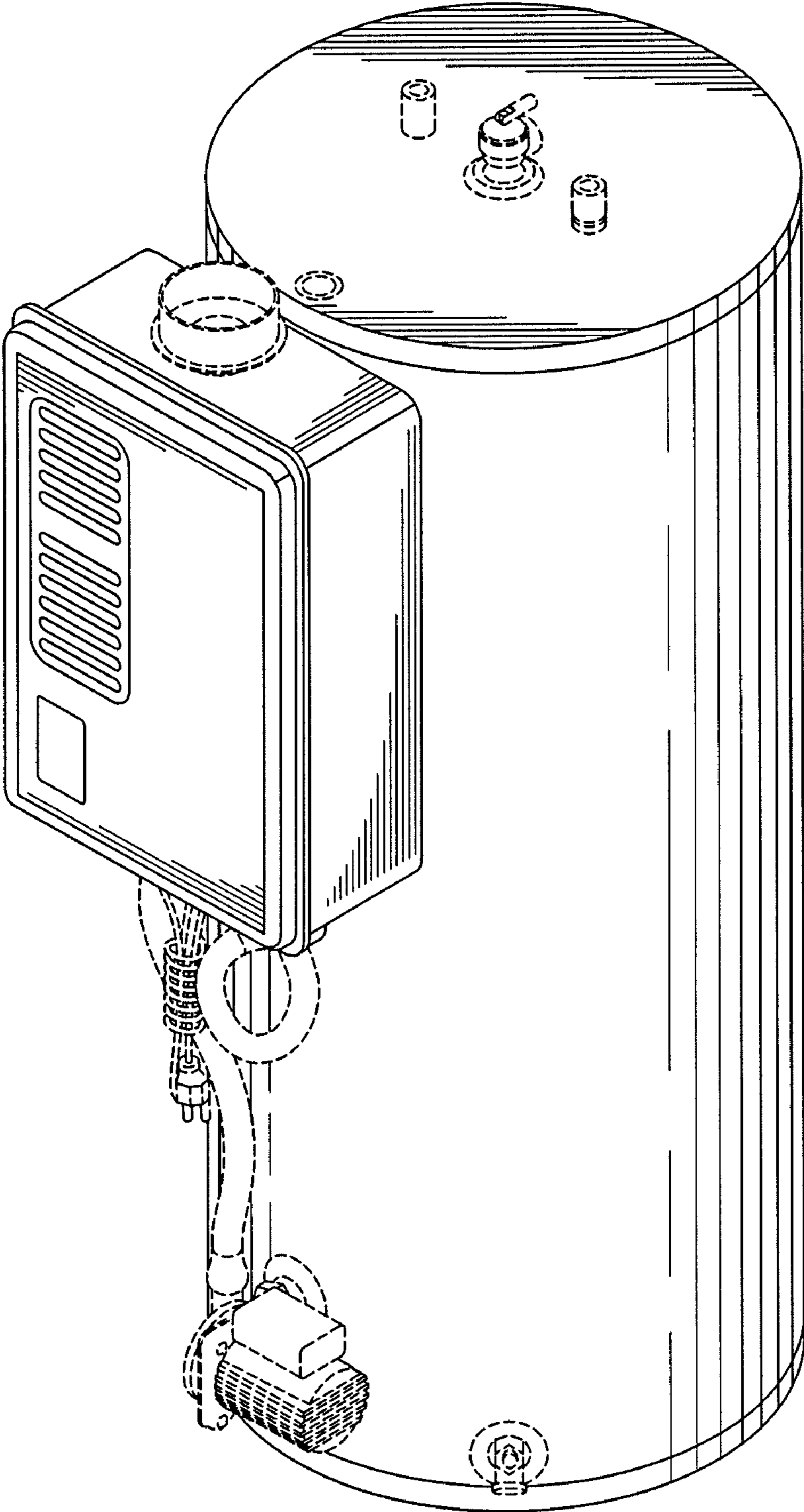

Fig-1

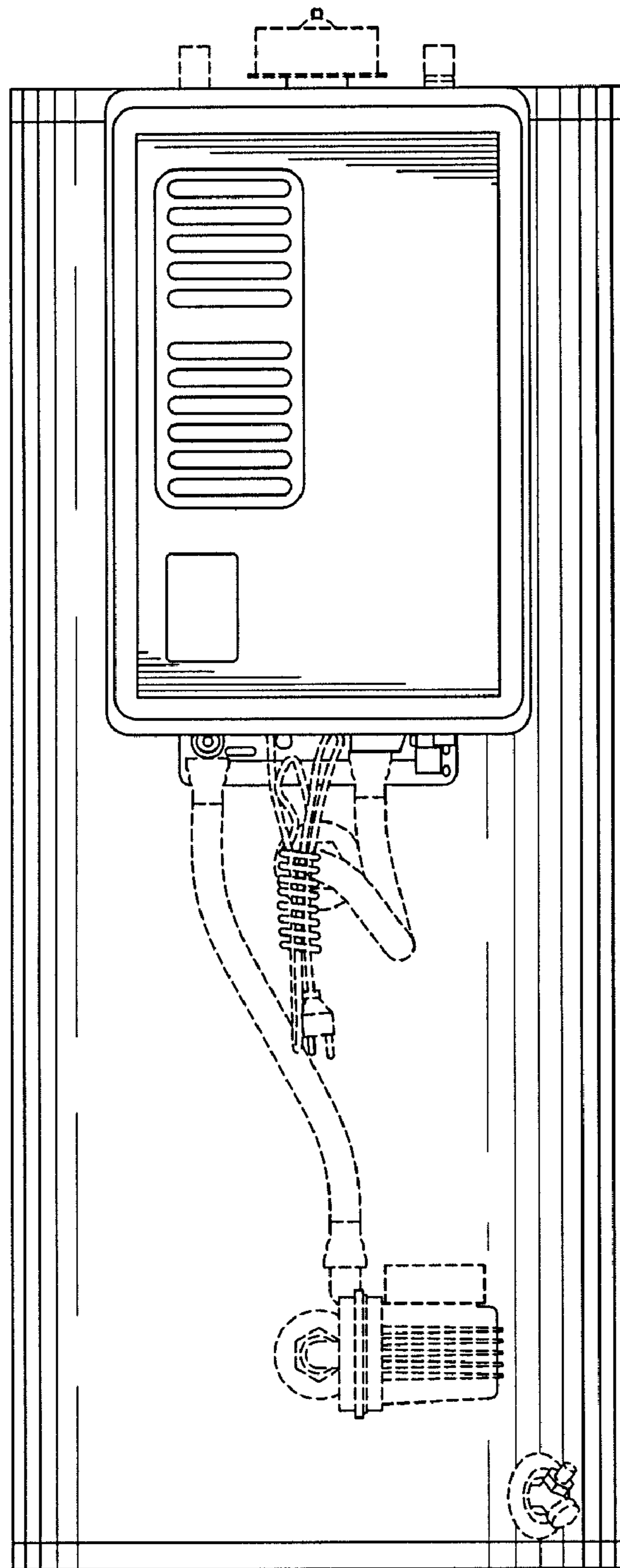

Fig. 2

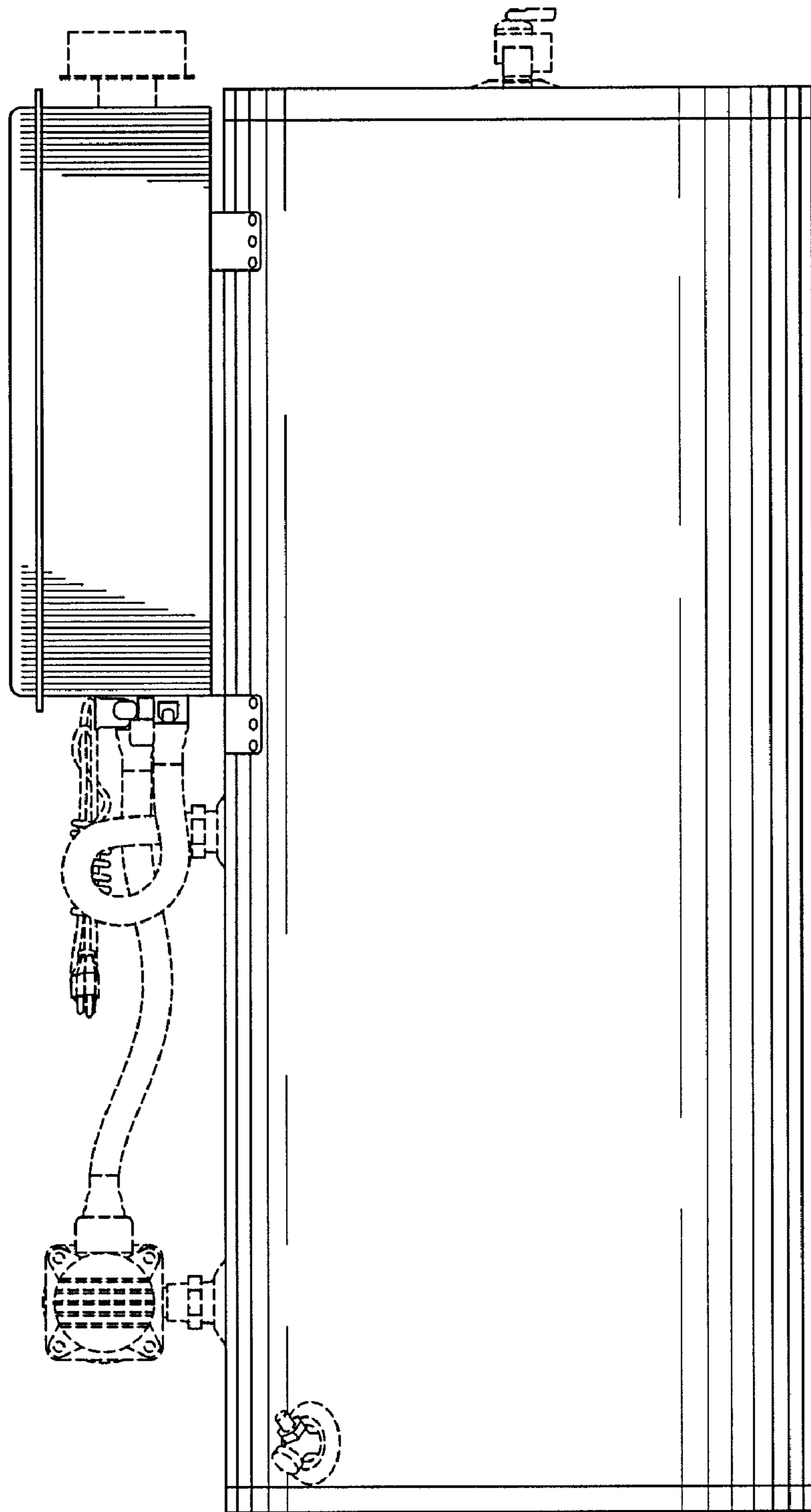

Fig-3

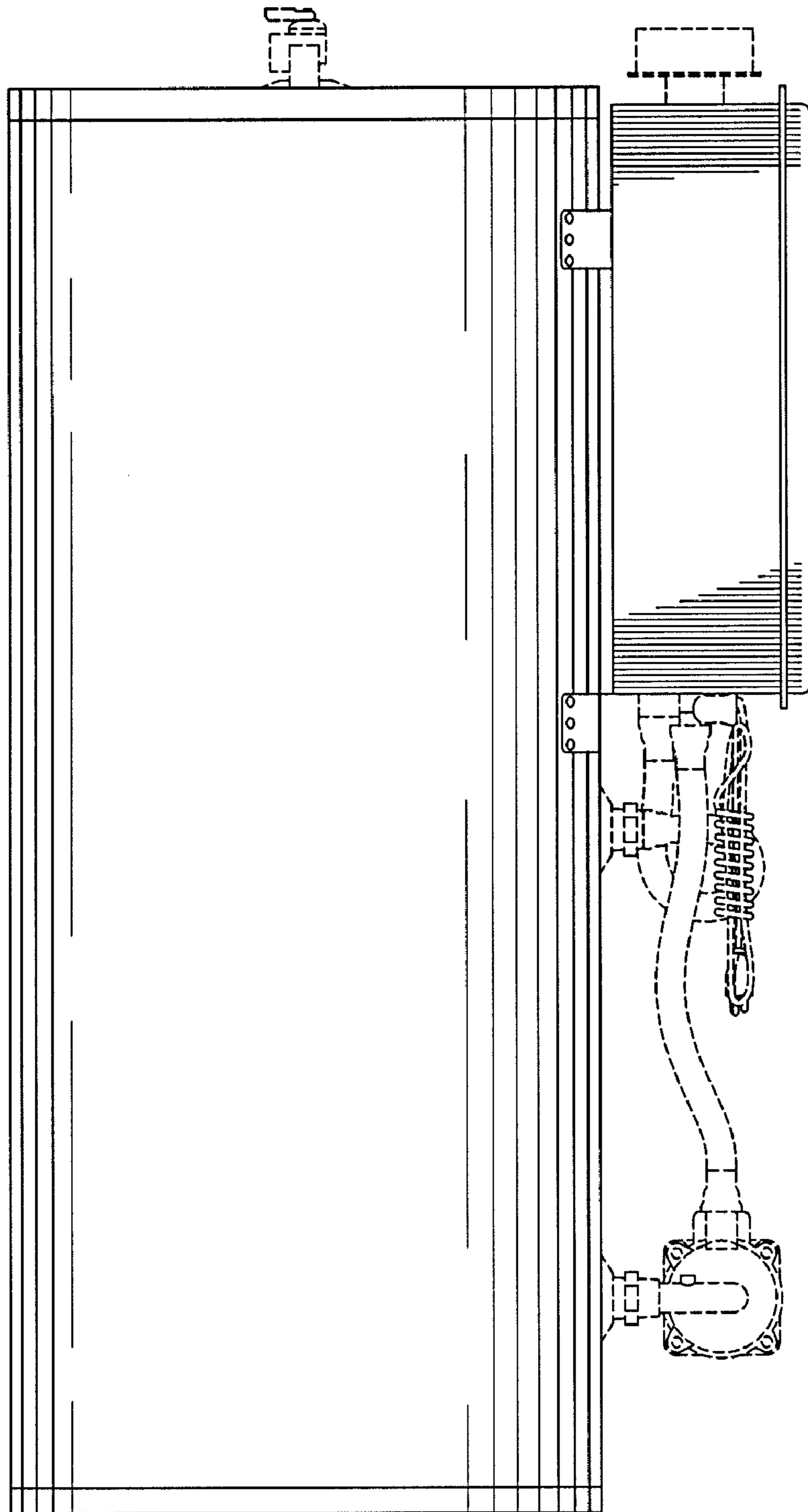

Fig. 4

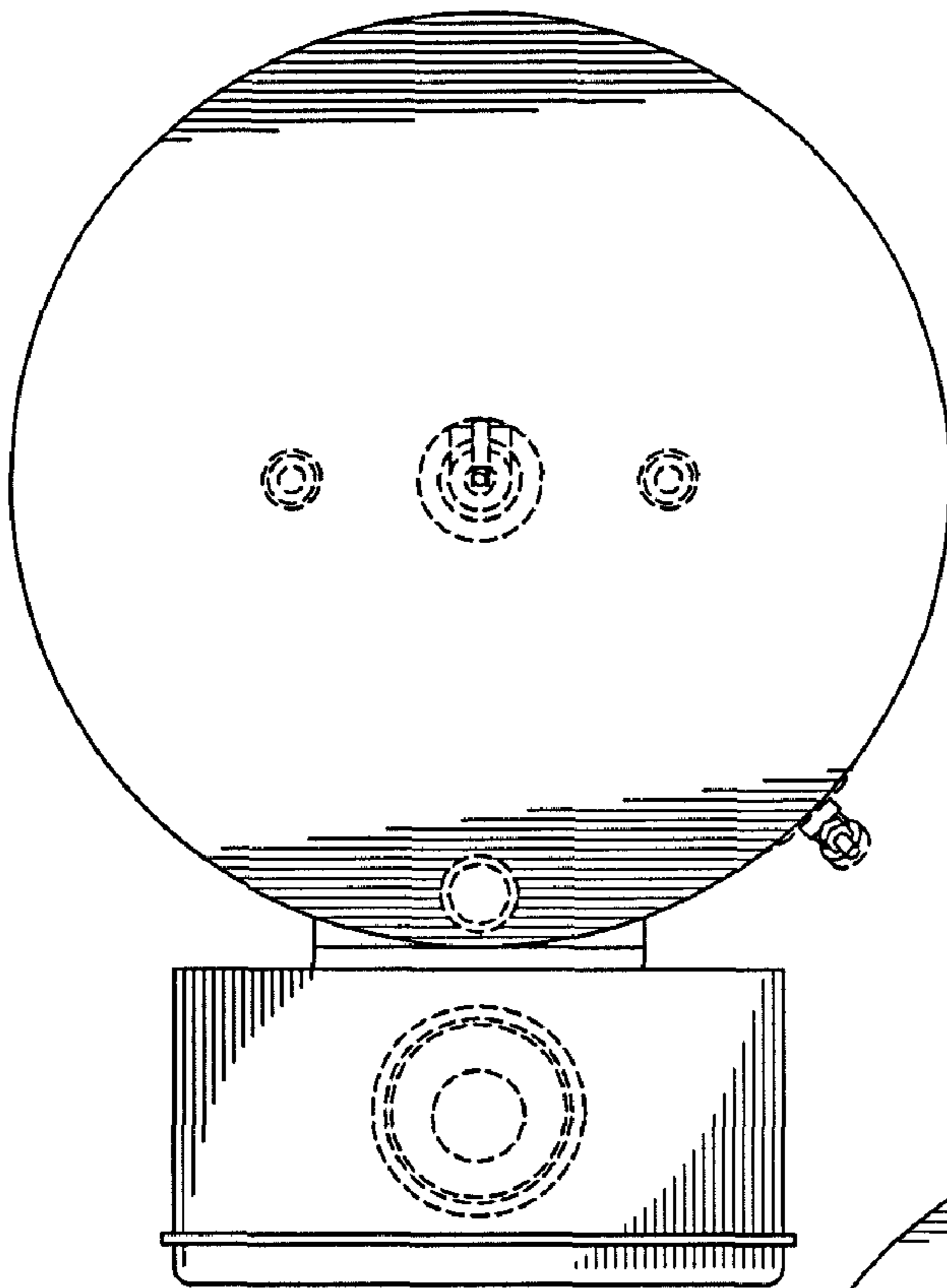

Fig-5

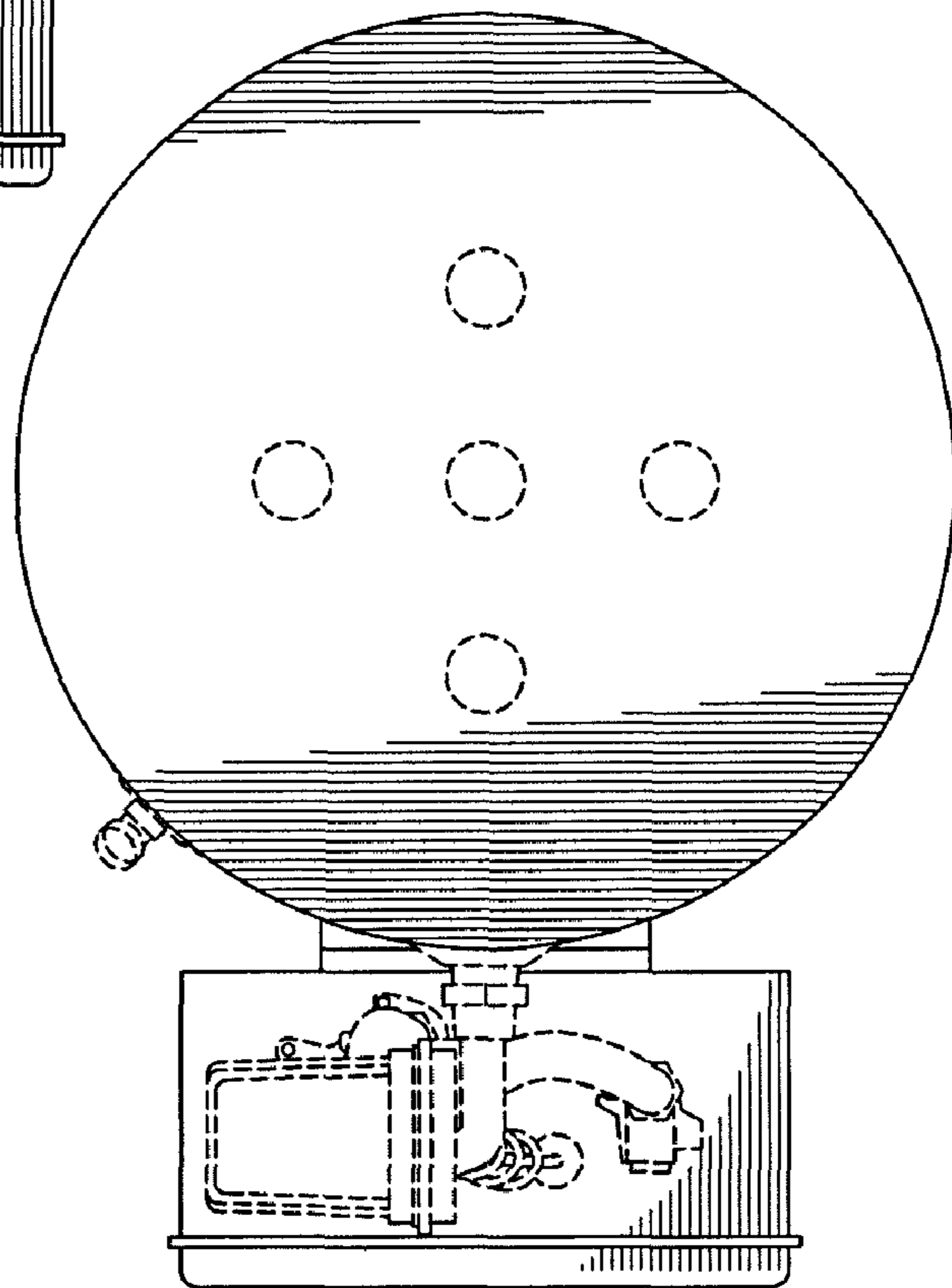

Fig-6