



US00D679399S

(12) **United States Design Patent**  
**Syu**

(10) **Patent No.:** **US D679,399 S**

(45) **Date of Patent:** **\*\* Apr. 2, 2013**

(54) **HEART RATE VARIABILITY ANALYZER**

(75) Inventor: **Zih-Fen Syu**, Taipei County (TW)

(73) Assignee: **Vicon Healthcare International Inc.**,  
Taipei County (TW)

(\*\*) Term: **14 Years**

(21) Appl. No.: **29/406,901**

(22) Filed: **Nov. 21, 2011**

(51) **LOC (9) Cl.** ..... **24-01**

(52) **U.S. Cl.** ..... **D24/167**

(58) **Field of Classification Search** ..... D24/165–168,  
D24/107, 186, 187; D10/31, 32, 38, 46,  
D10/78, 98; 600/301, 382, 384, 481, 483,  
600/485, 500–504, 508, 509, 587; D14/336,  
D14/341, 371, 126

See application file for complete search history.

(56) **References Cited**

**U.S. PATENT DOCUMENTS**

D293,023	S	*	12/1987	Giurtino	.....	D24/167
D456,895	S	*	5/2002	Sakai et al.	.....	D24/107
D536,793	S	*	2/2007	Assad et al.	.....	D24/185
D554,266	S	*	10/2007	Striepe et al.	.....	D24/186

D598,551	S	*	8/2009	Miwa et al.	.....	D24/186
D609,706	S	*	2/2010	Helt et al.	.....	D14/426
D613,411	S	*	4/2010	Collins et al.	.....	D24/186
D627,476	S	*	11/2010	Gaw et al.	.....	D24/186

\* cited by examiner

*Primary Examiner* — Anhdao Doan

(74) *Attorney, Agent, or Firm* — WPAT, P.C.; Anthony King

(57) **CLAIM**

The ornamental design for a heart rate variability analyzer, as shown and described.

**DESCRIPTION**

FIG. 1 is a top perspective of a heart rate variability analyzer showing my new design;  
FIG. 2 is a front elevational view thereof;  
FIG. 3 is a rear elevational view thereof;  
FIG. 4 is a left side view thereof;  
FIG. 5 is a right side view thereof;  
FIG. 6 is a top plan view thereof; and,  
FIG. 7 is a bottom plan view thereof.

The broken lines in the drawing views are included for the purpose of illustrating portions of the heart rate variability analyzer that form no part of the claimed design.

**1 Claim, 4 Drawing Sheets**

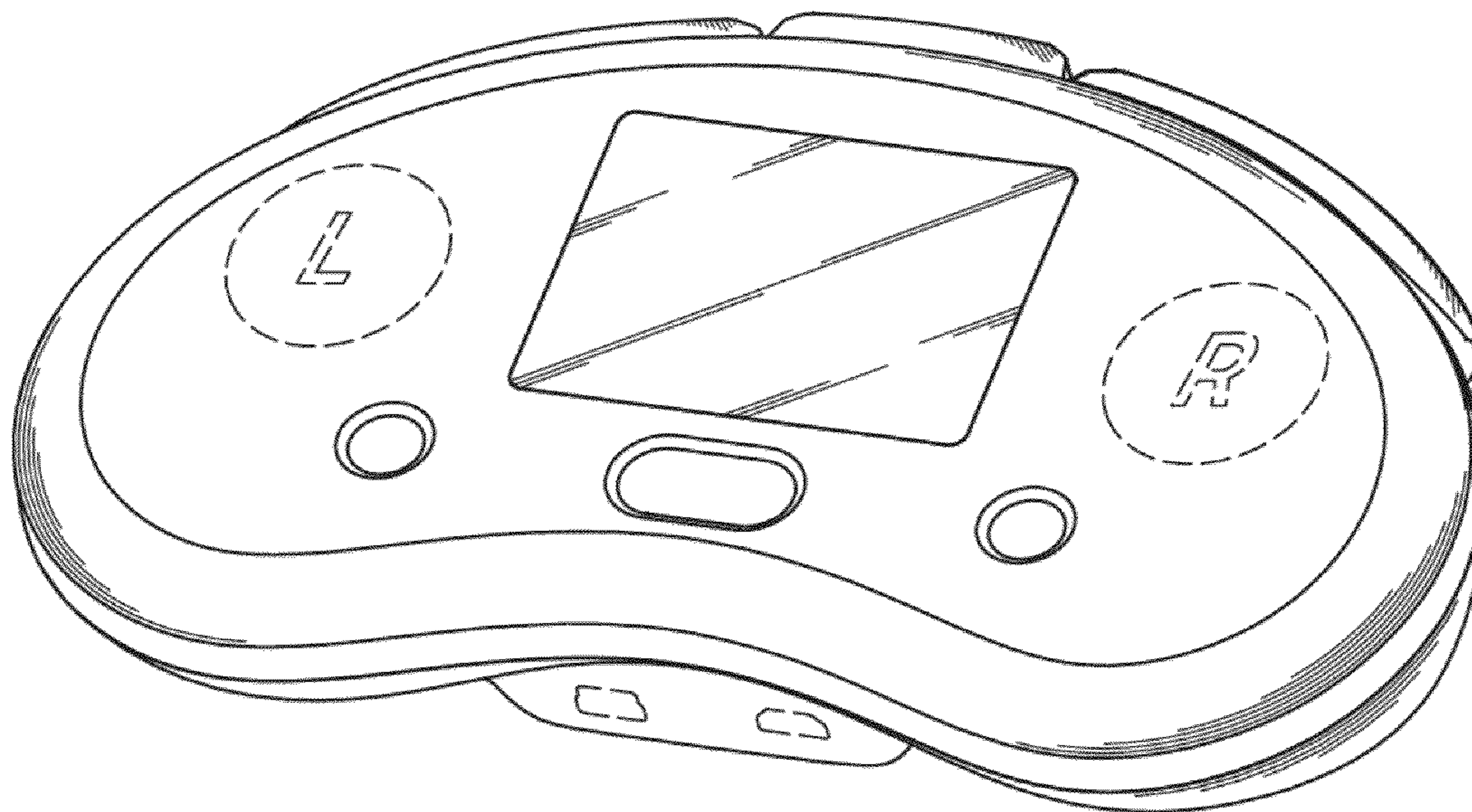

FIG.1

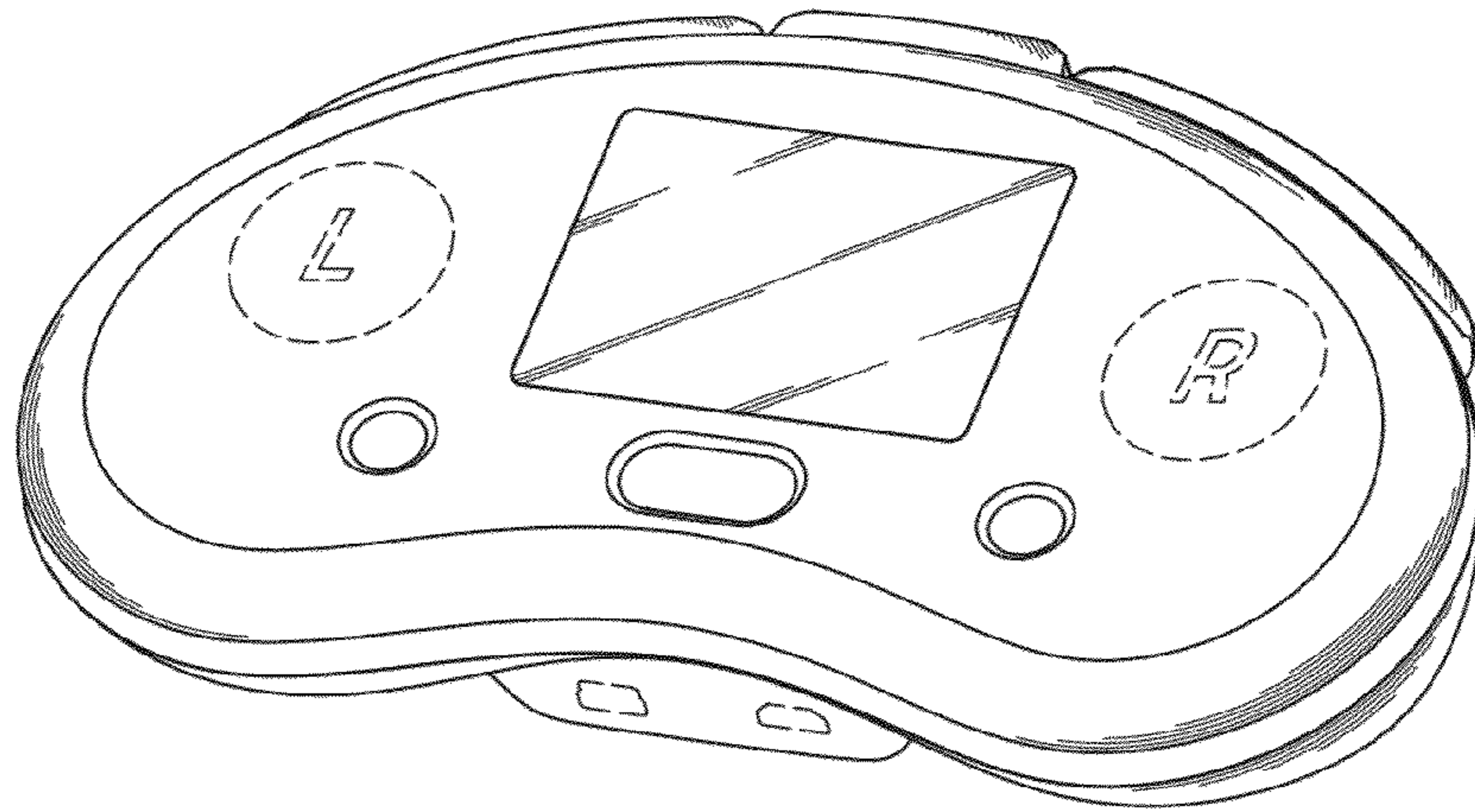

FIG.2

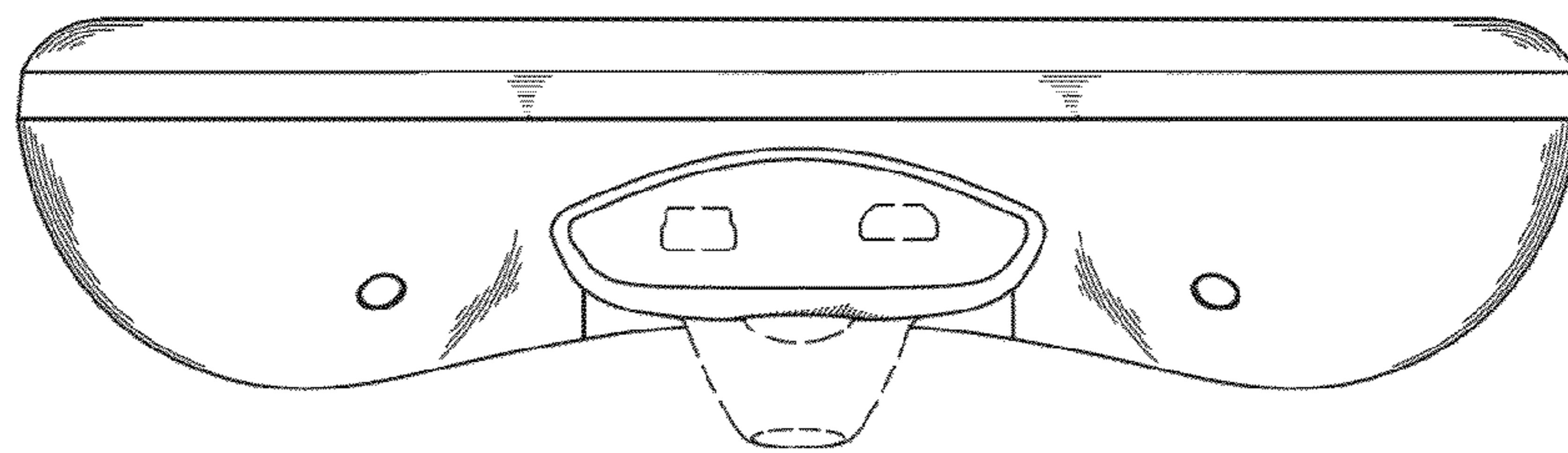

FIG.3

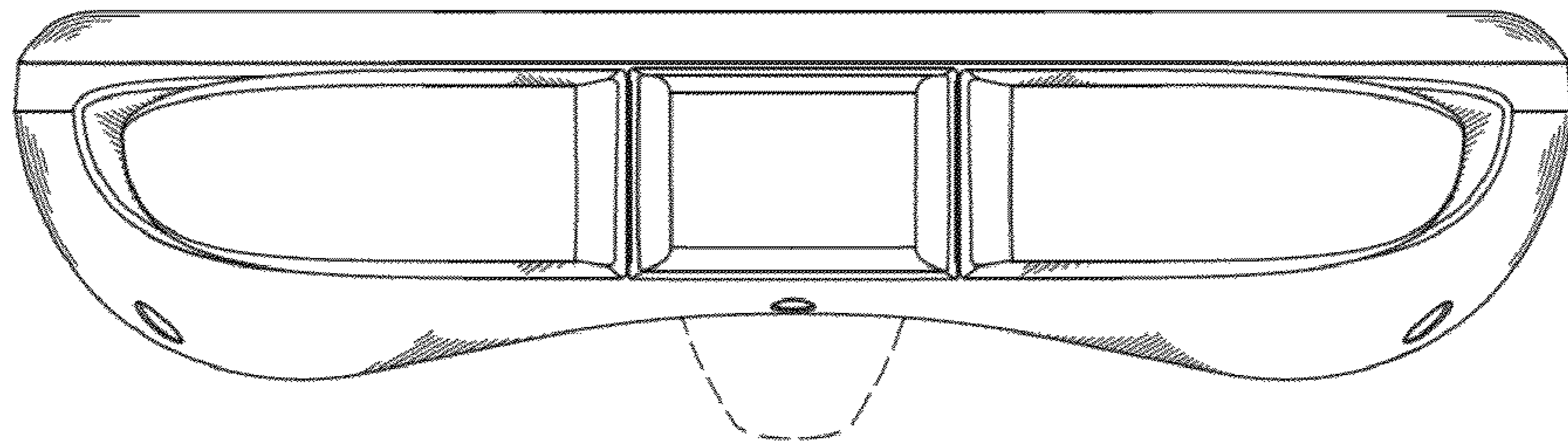

FIG.4

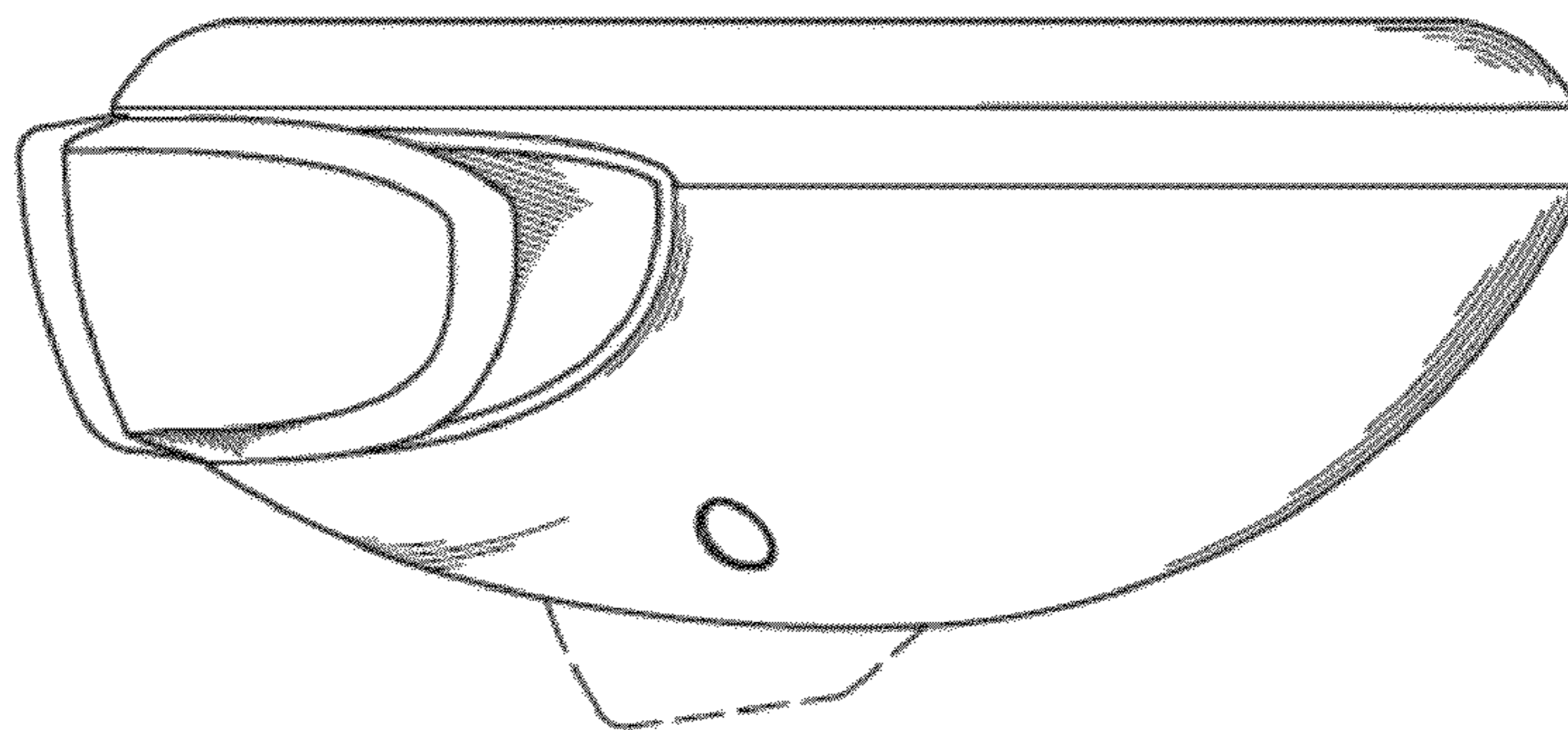

FIG.5

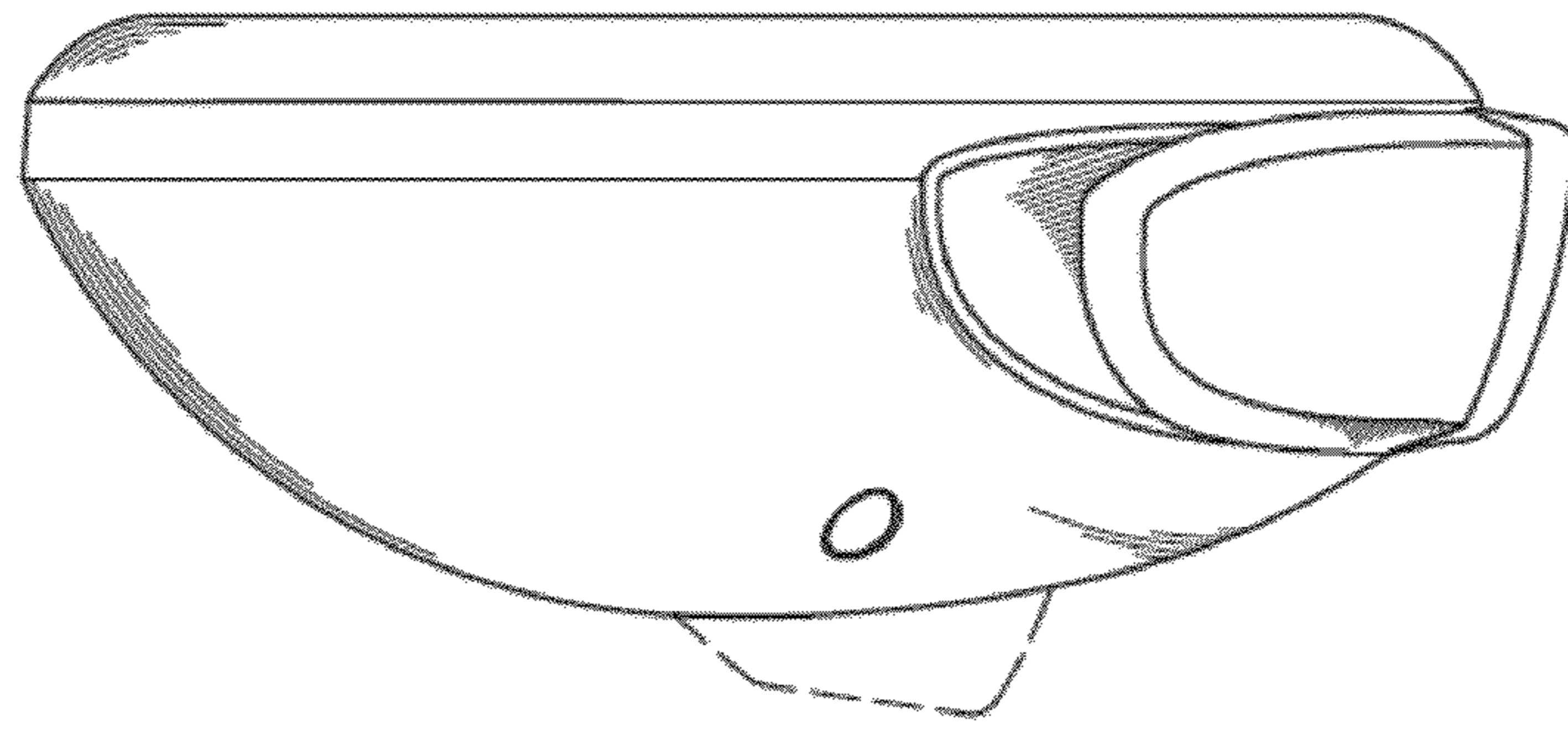

FIG.6

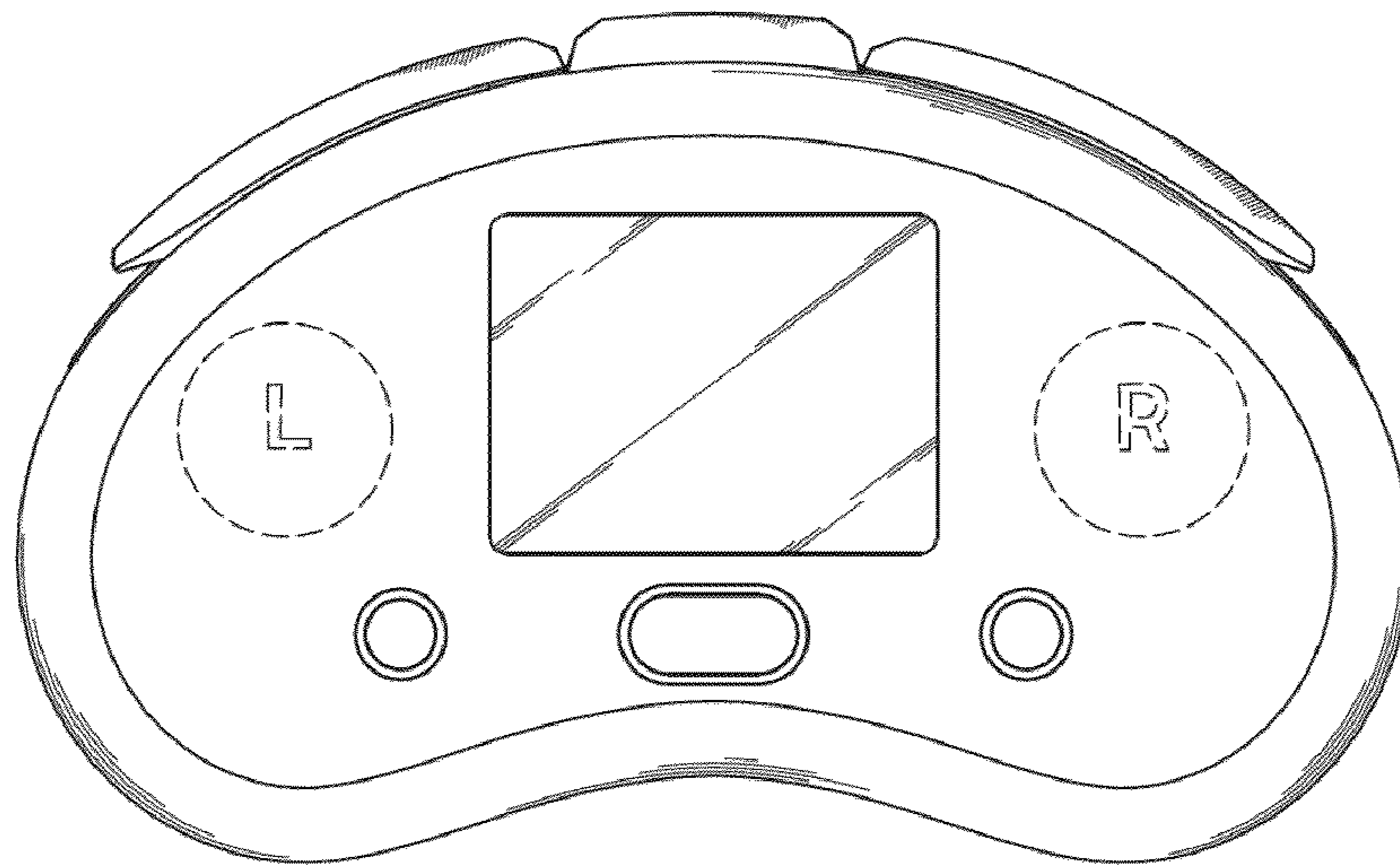

FIG.7

