



US00D679359S

(12) **United States Design Patent**
Adock, Jr.

(10) **Patent No.:** **US D679,359 S**

(45) **Date of Patent:** **** Apr. 2, 2013**

(54) **LOW PROFILE GUN SIGHT**

(76) **Inventor:** **Torrance L. Adock, Jr.**, Bethesda, MD
(US)

(**) **Term:** **14 Years**

(21) **Appl. No.:** **29/374,680**

(22) **Filed:** **Sep. 21, 2011**

(51) **LOC (9) Cl.** **22-01**

(52) **U.S. Cl.** **D22/109; D22/108**

(58) **Field of Classification Search** D22/108-109;
42/111-105; D26/38-39; 359/409-411;
33/227, 229; 89/200-204; D16/130-136

See application file for complete search history.

(56) **References Cited**

U.S. PATENT DOCUMENTS

561,360	A	6/1896	Taylor	
805,770	A	11/1905	Bassell et al.	
4,291,478	A *	9/1981	Lough	42/117
4,367,606	A *	1/1983	Bechtel	42/127
4,375,725	A	3/1983	Orlob	
4,418,487	A *	12/1983	Strahan	42/125
5,822,872	A	10/1998	Waki	
5,878,521	A	3/1999	Warnock	
D410,061	S *	5/1999	Emerson	D22/110
D435,885	S *	1/2001	Wallace	D22/110

6,321,479	B1	11/2001	Sheehan	
6,732,467	B1	5/2004	Luth	
7,069,685	B2 *	7/2006	Houde-Walter	42/132
D526,380	S	8/2006	Swan	
7,356,962	B2	4/2008	Swan	
7,562,486	B2	7/2009	LoRocco	
2007/0240354	A1	10/2007	Warren	

* cited by examiner

Primary Examiner — Michael A Pratt

(74) *Attorney, Agent, or Firm* — John P. McGonagle

(57) **CLAIM**

The ornamental design for a low profile gun sight, as shown and described.

DESCRIPTION

FIG. 1 is a rear view of a low profile gun sight showing my new design, wherein a partial view of the rear portion of a hand gun is shown in broken lines for illustrative purposes only and forms no part of the claimed design;

FIG. 2 is a top perspective view thereof;

FIG. 3 is a right side view thereof;

FIG. 4 is a left side view thereof;

FIG. 5 is a top view thereof;

FIG. 6 is a front view thereof; and,

FIG. 7 is a bottom view thereof.

1 Claim, 3 Drawing Sheets

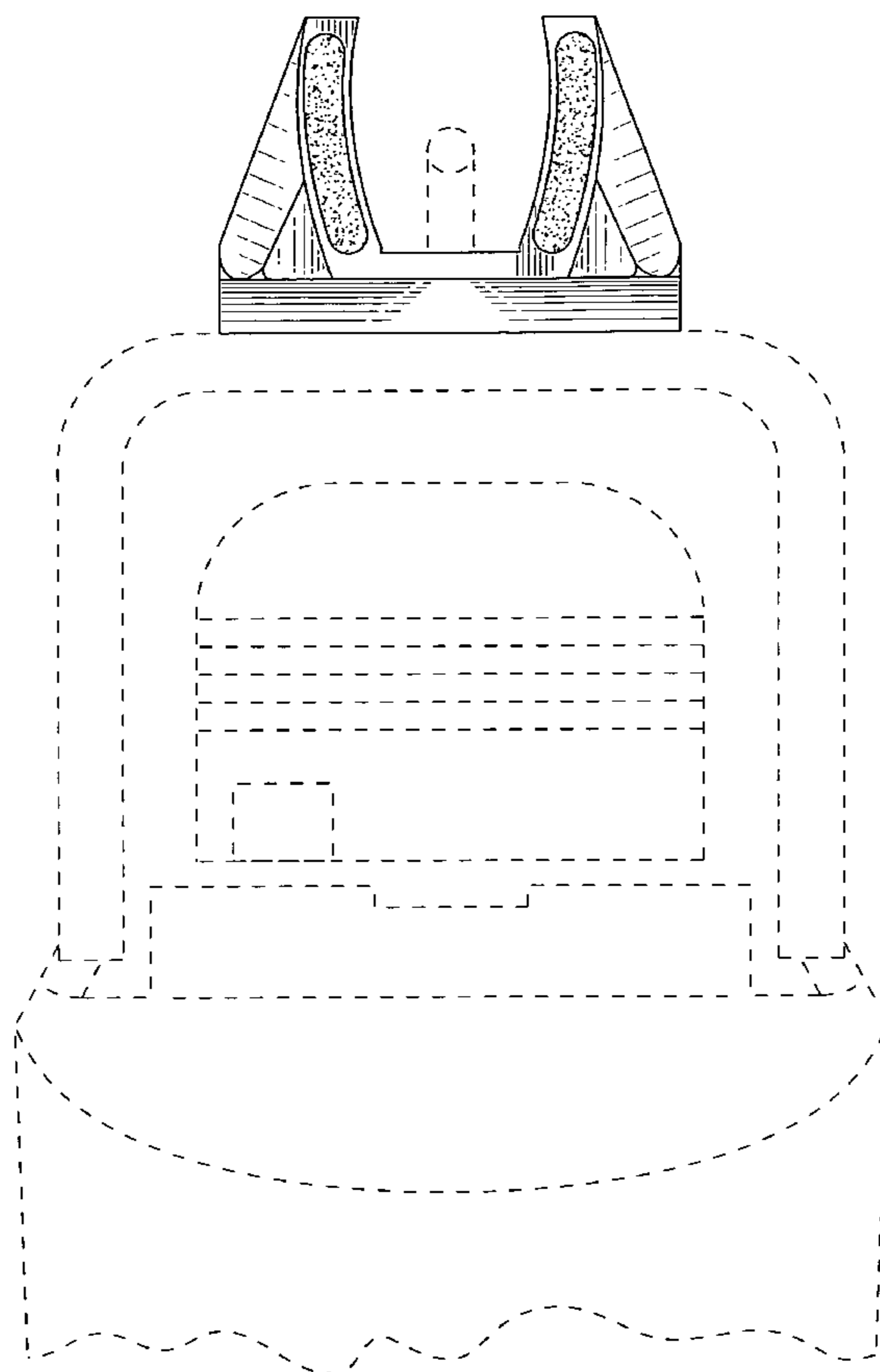

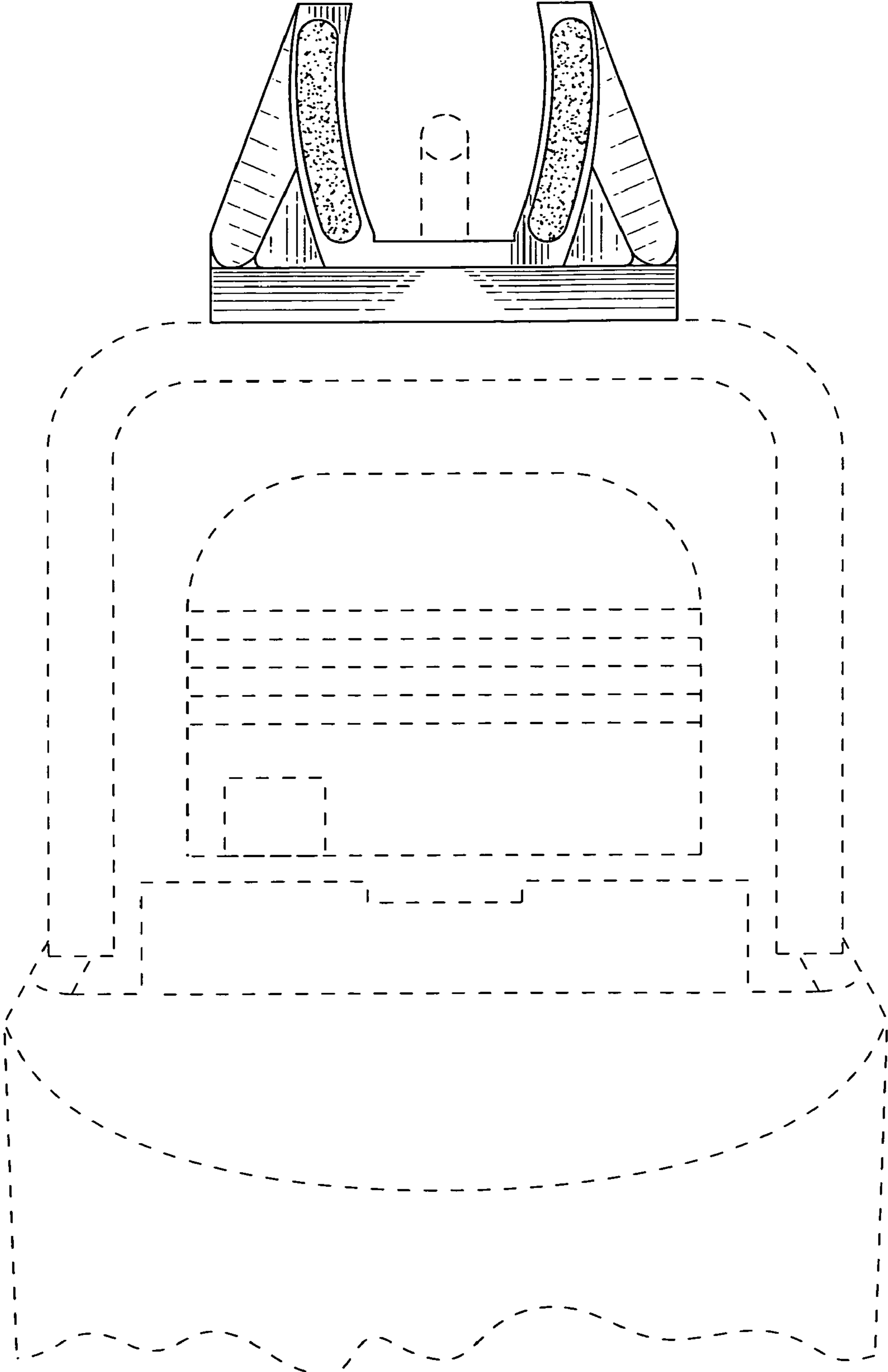

FIG. 1

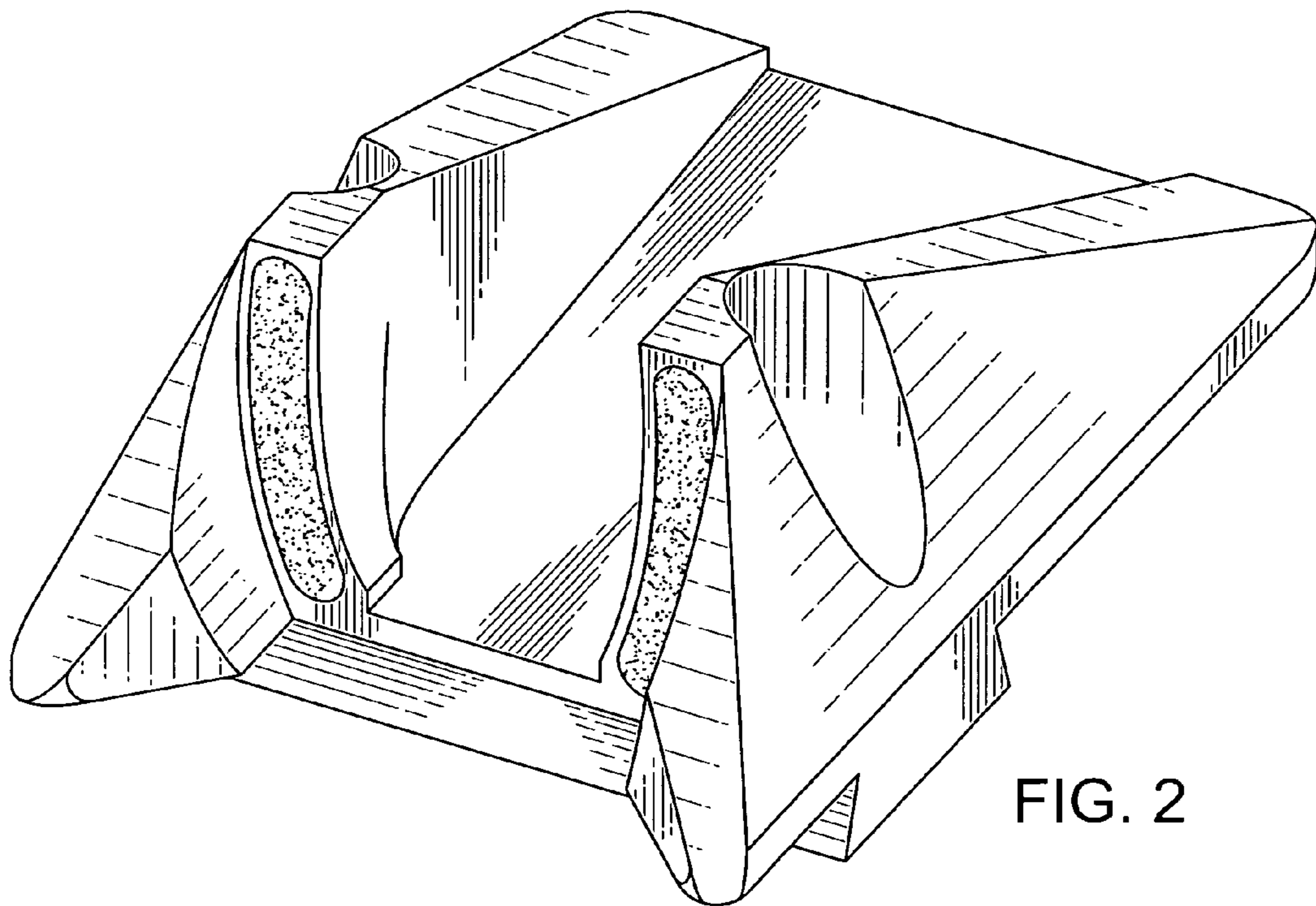

FIG. 2

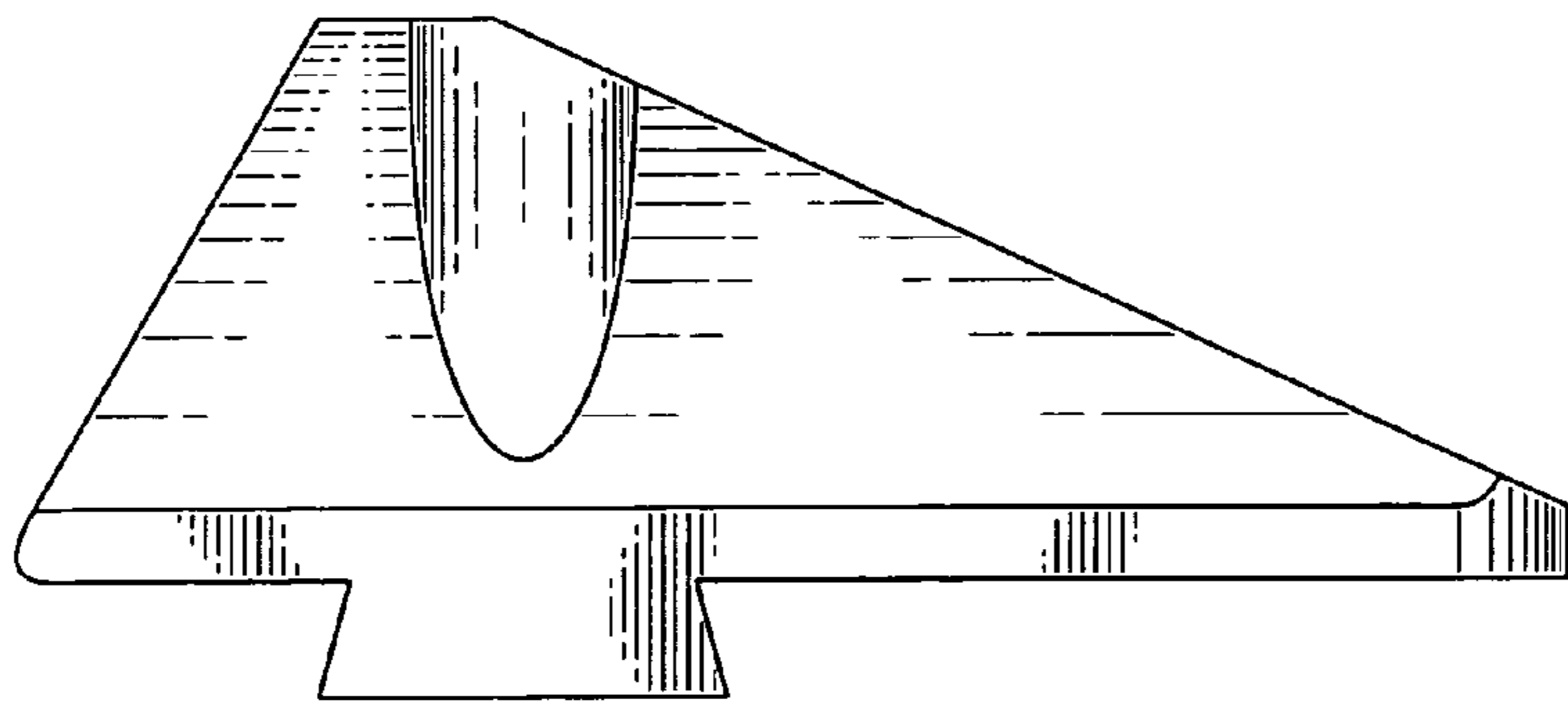
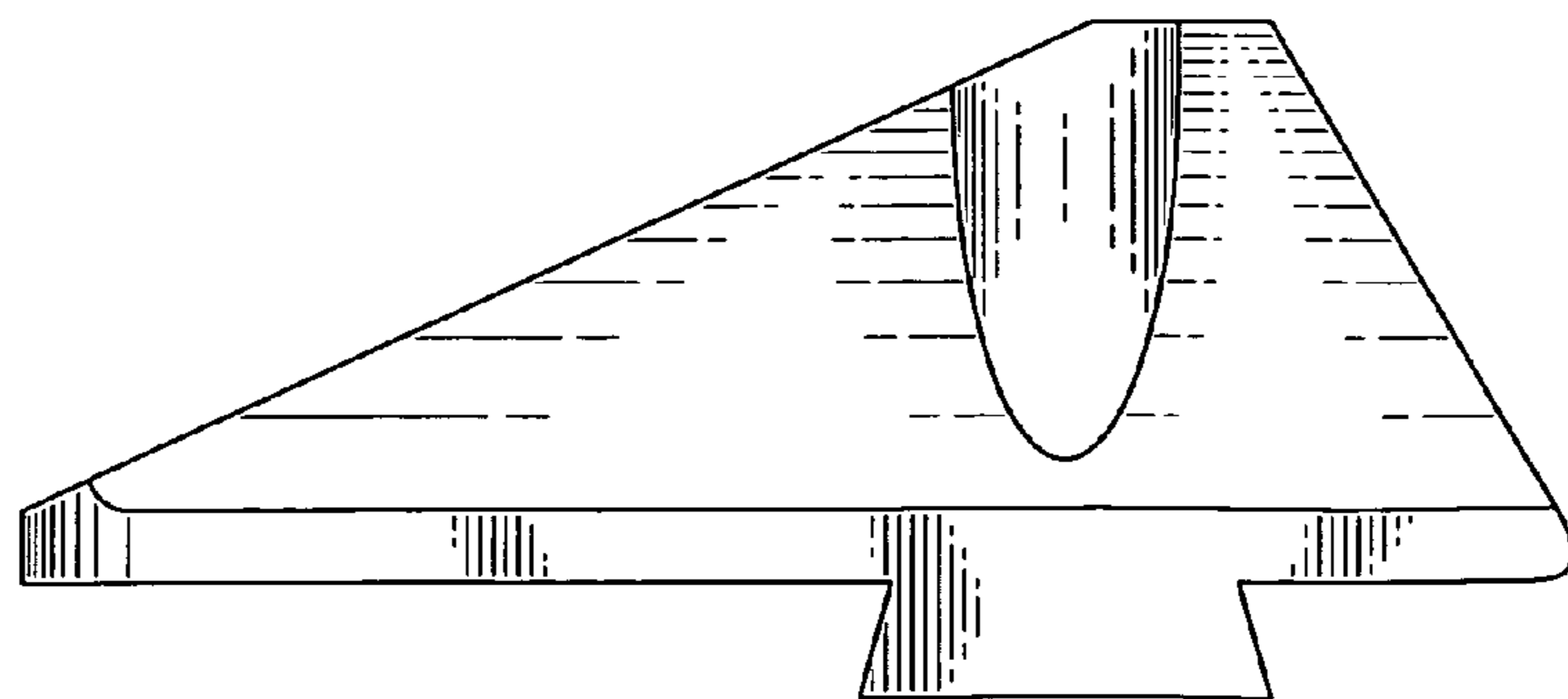

FIG. 3

FIG. 4



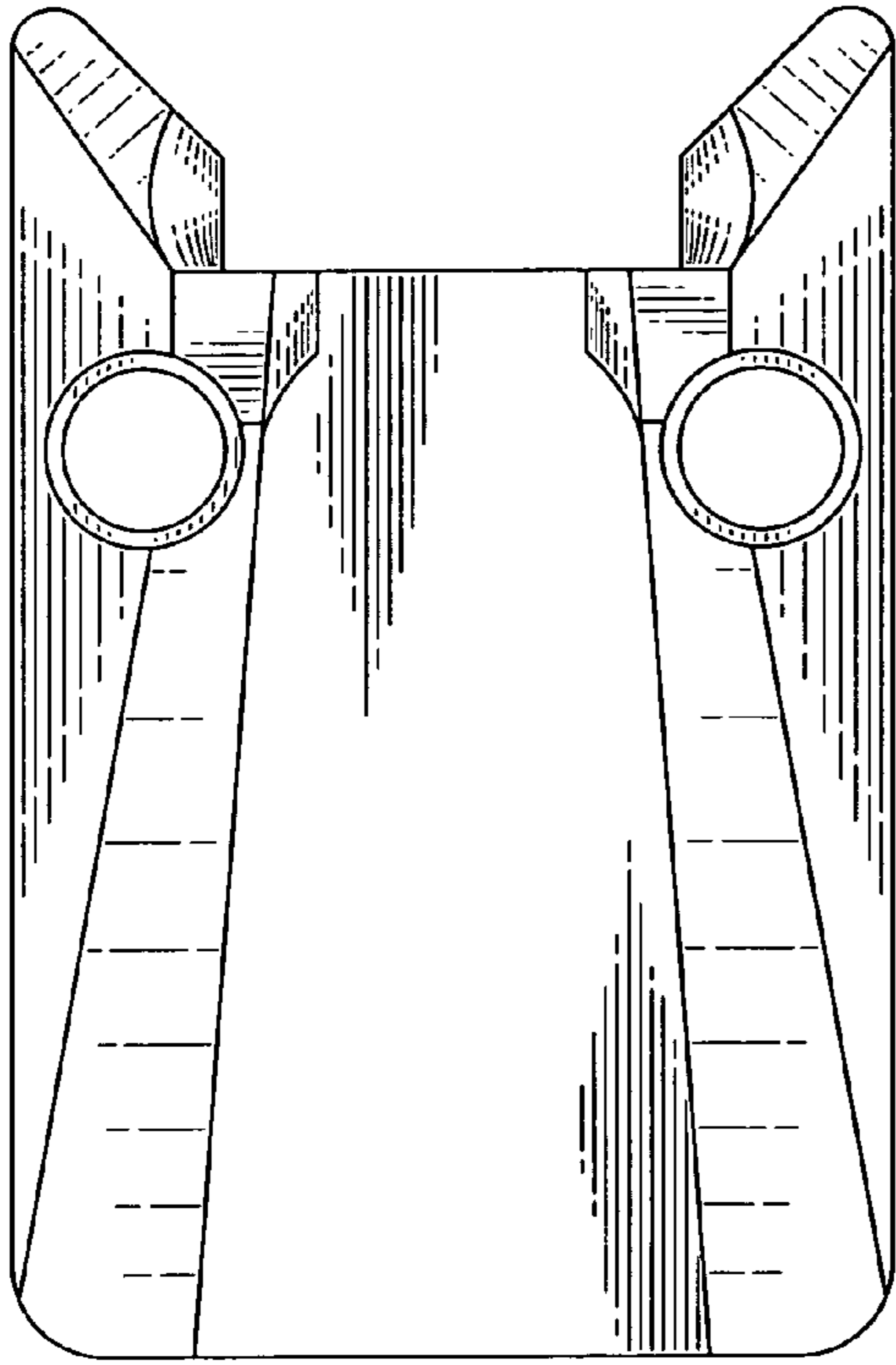

FIG. 5

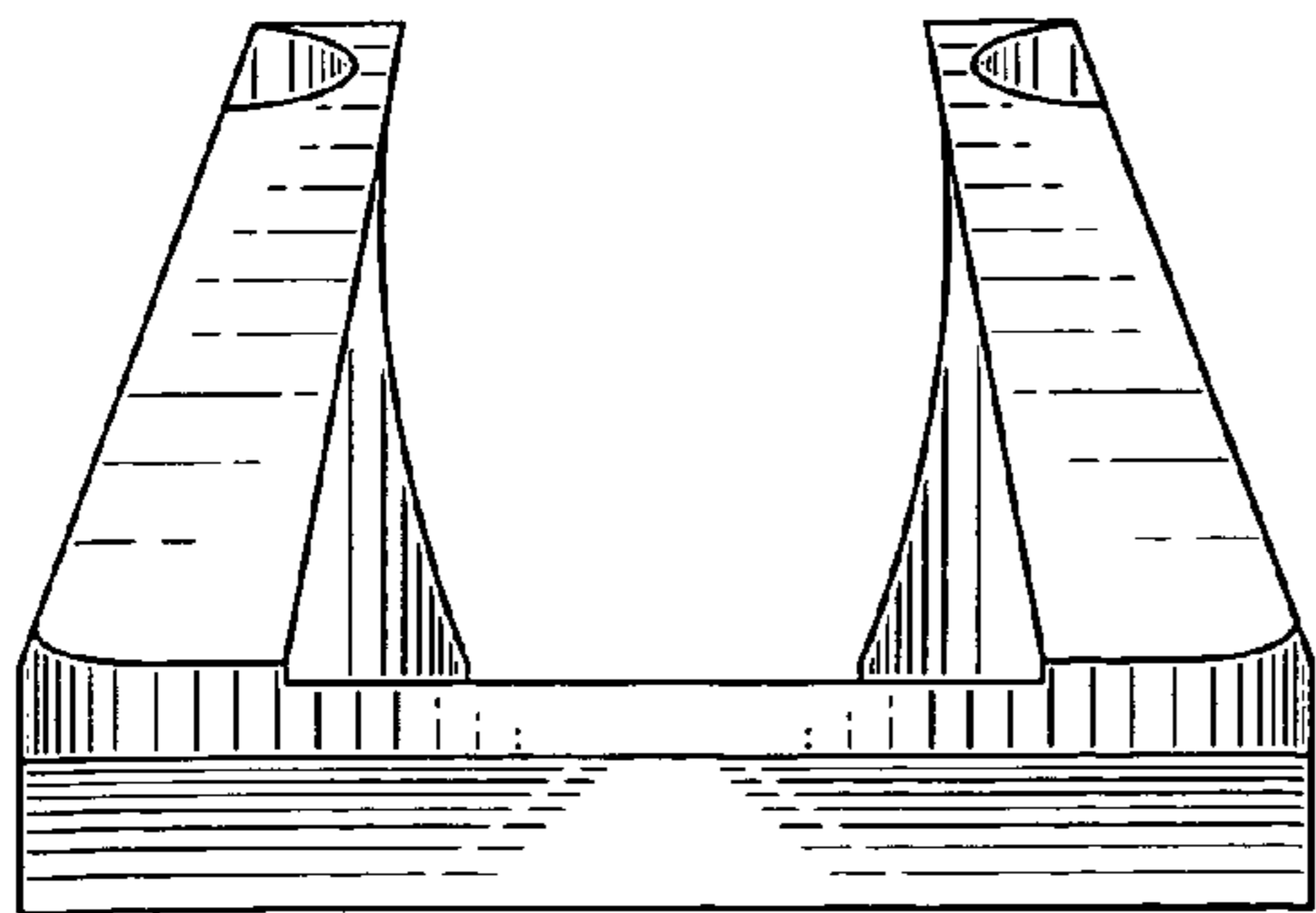

FIG. 6

FIG. 7

