



US00D679335S

(12) **United States Design Patent**
Bengyak

(10) **Patent No.:** **US D679,335 S**

(45) **Date of Patent:** **** Apr. 2, 2013**

(54) **HAND SIGN**

(76) **Inventor:** **Christopher Edward Bengyak**, Vero Beach, FL (US)

(**) **Term:** **14 Years**

(21) **Appl. No.:** **29/395,309**

(22) **Filed:** **Dec. 29, 2011**

(51) **LOC (9) Cl.** **20-03**

(52) **U.S. Cl.** **D20/35; D20/33**

(58) **Field of Classification Search** D20/10,
D20/29-33, 35, 36, 99; 40/446, 538, 541,
40/584, 586; D1/113; D2/615, 862; D21/400,
D21/869; D19/90

See application file for complete search history.

(56) **References Cited**

U.S. PATENT DOCUMENTS

D406,437 S *	3/1999	Tulleners	D2/869
D408,456 S *	4/1999	Garner	D19/90
D417,769 S *	12/1999	Cauthen	D2/869
D429,285 S *	8/2000	Schini	D20/32
D436,712 S *	1/2001	Smith	D1/113
D656,198 S *	3/2012	Bengyak	D20/30
D662,548 S *	6/2012	Bengyak	D20/29
D662,552 S *	6/2012	Bengyak	D20/29
D664,208 S *	7/2012	Bengyak	D20/29

* cited by examiner

Primary Examiner — Mary Ann Calabrese

(57) **CLAIM**

The ornamental design for a hand sign, as shown and described.

DESCRIPTION

FIG. 1 is a right-side elevational view of a first embodiment of a left-hand hand sign according to the invention;
 FIG. 2 is a left-side elevational view of the left-hand hand sign of FIG. 1;
 FIG. 3 is an enlarged rear elevational view of the left-hand hand sign of FIG. 1;
 FIG. 4 is an enlarged top plan view of the left-hand hand sign of FIG. 1;
 FIG. 5 is an enlarged bottom plan view of the left-hand hand sign of FIG. 1;
 FIG. 6 is an enlarged front plan view of the left-hand hand sign of FIG. 1;

FIG. 7 is a perspective view from below the front of the right side of the left-hand hand sign of FIG. 1;
 FIG. 8 is a perspective view from above the rear of the right side of the left-hand hand sign of FIG. 1;
 FIG. 9 is a left-side elevational view of a second embodiment of a right-hand hand sign according to the invention;
 FIG. 10 is a right-side elevational view of the right-hand hand sign of FIG. 9;
 FIG. 11 is an enlarged front elevational view of the right-hand hand sign of FIG. 9;
 FIG. 12 is an enlarged top plan view of the right-hand hand sign of FIG. 9;
 FIG. 13 is an enlarged bottom plan view of the right-hand hand sign of FIG. 9;
 FIG. 14 is an enlarged rear elevational view of the right-hand hand sign of FIG. 9;
 FIG. 15 is a perspective view from below the front of the left side of the right-hand hand sign of FIG. 9;
 FIG. 16 is a perspective view from above the rear of the left side of the right-hand hand sign of FIG. 9;
 FIG. 17 is a right-side elevational view of a third embodiment of a left-hand hand sign according to the invention;
 FIG. 18 is a left-side elevational view of the left-hand hand sign of FIG. 17;
 FIG. 19 is an enlarged rear elevational view of the left-hand hand sign of FIG. 17;
 FIG. 20 is an enlarged top plan view of the left-hand hand sign of FIG. 17;
 FIG. 21 is an enlarged bottom plan view of the left-hand hand sign of FIG. 17;
 FIG. 22 is an enlarged front plan view of the left-hand hand sign of FIG. 17;
 FIG. 23 is a perspective view from below the front of the right side of the left-hand hand sign of FIG. 17;
 FIG. 24 is a perspective view from above the rear of the right side of the left-hand hand sign of FIG. 17;
 FIG. 25 is a left-side elevational view of a fourth embodiment of a right-hand hand sign according to the invention;
 FIG. 26 is a right-side elevational view of the right-hand hand sign of FIG. 25;
 FIG. 27 is an enlarged front elevational view of the right-hand hand sign of FIG. 25;
 FIG. 28 is an enlarged top plan view of the right-hand hand sign of FIG. 25;
 FIG. 29 is an enlarged bottom plan view of the right-hand hand sign of FIG. 25;
 FIG. 30 is an enlarged rear elevational view of the right-hand hand sign of FIG. 25;
 FIG. 31 is a perspective view from below the front of the left side of the right-hand hand sign of FIG. 25; and,
 FIG. 32 is a perspective view from above the rear of the left side of the right-hand hand sign of FIG. 25.

1 Claim, 12 Drawing Sheets

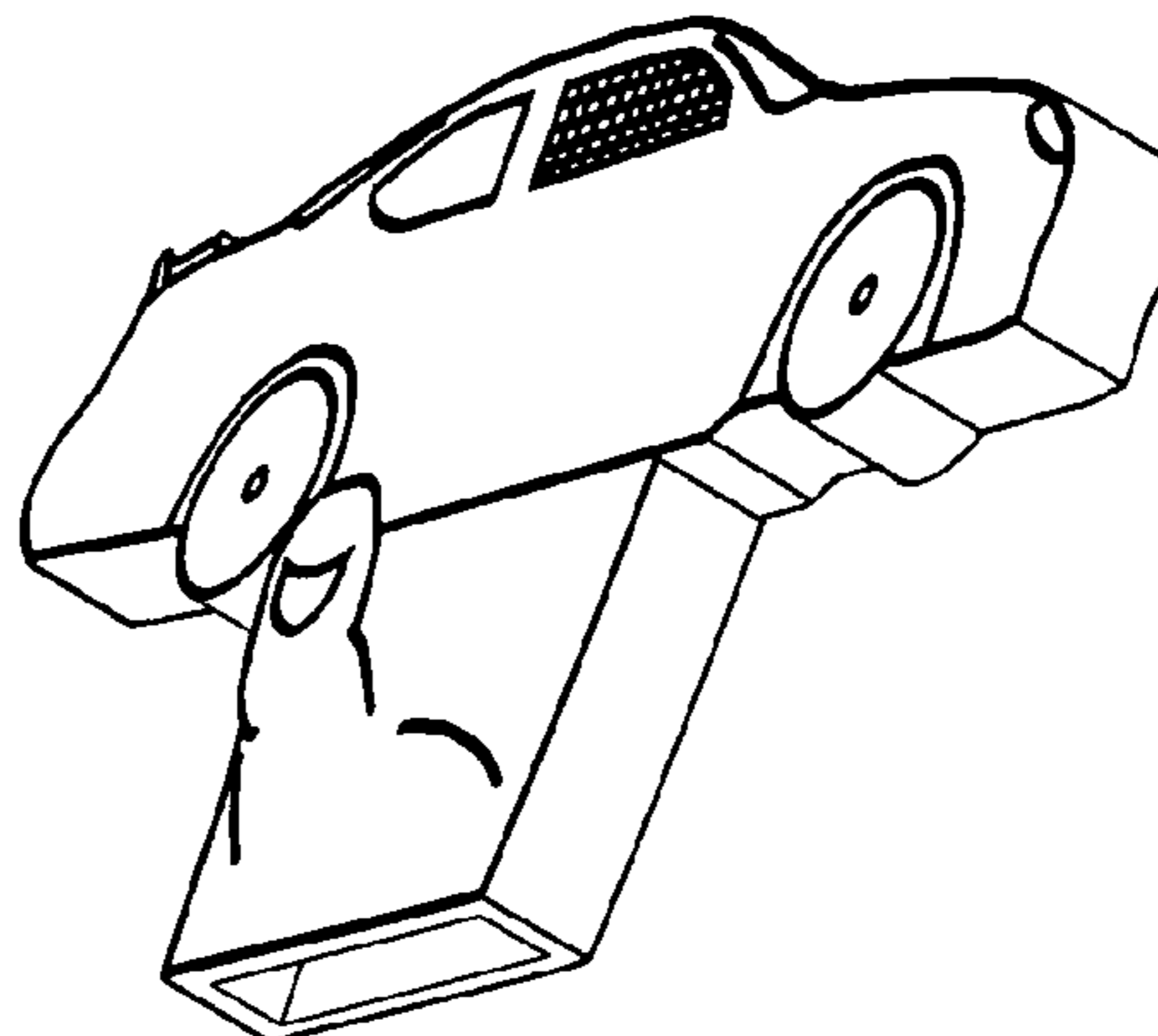
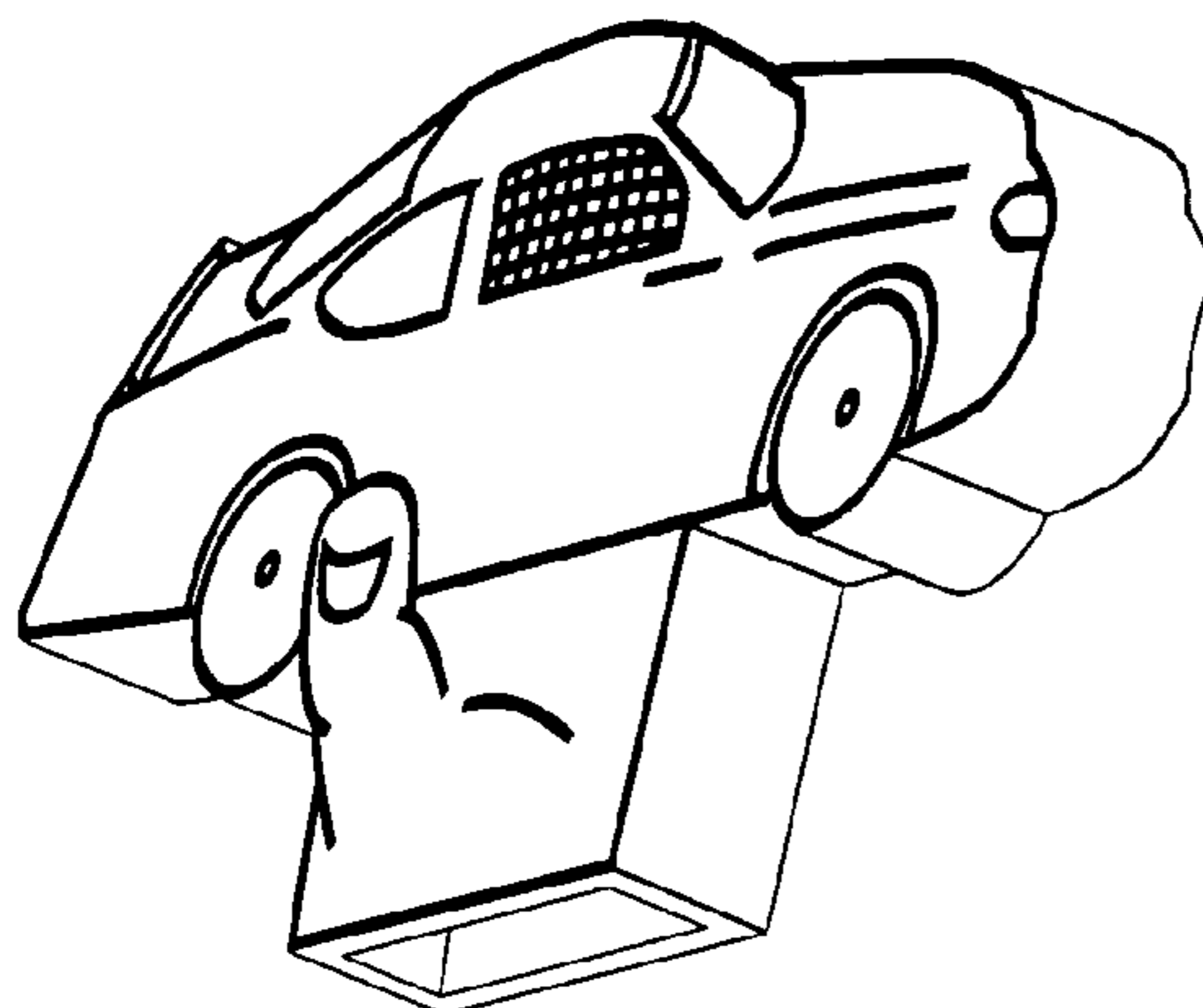

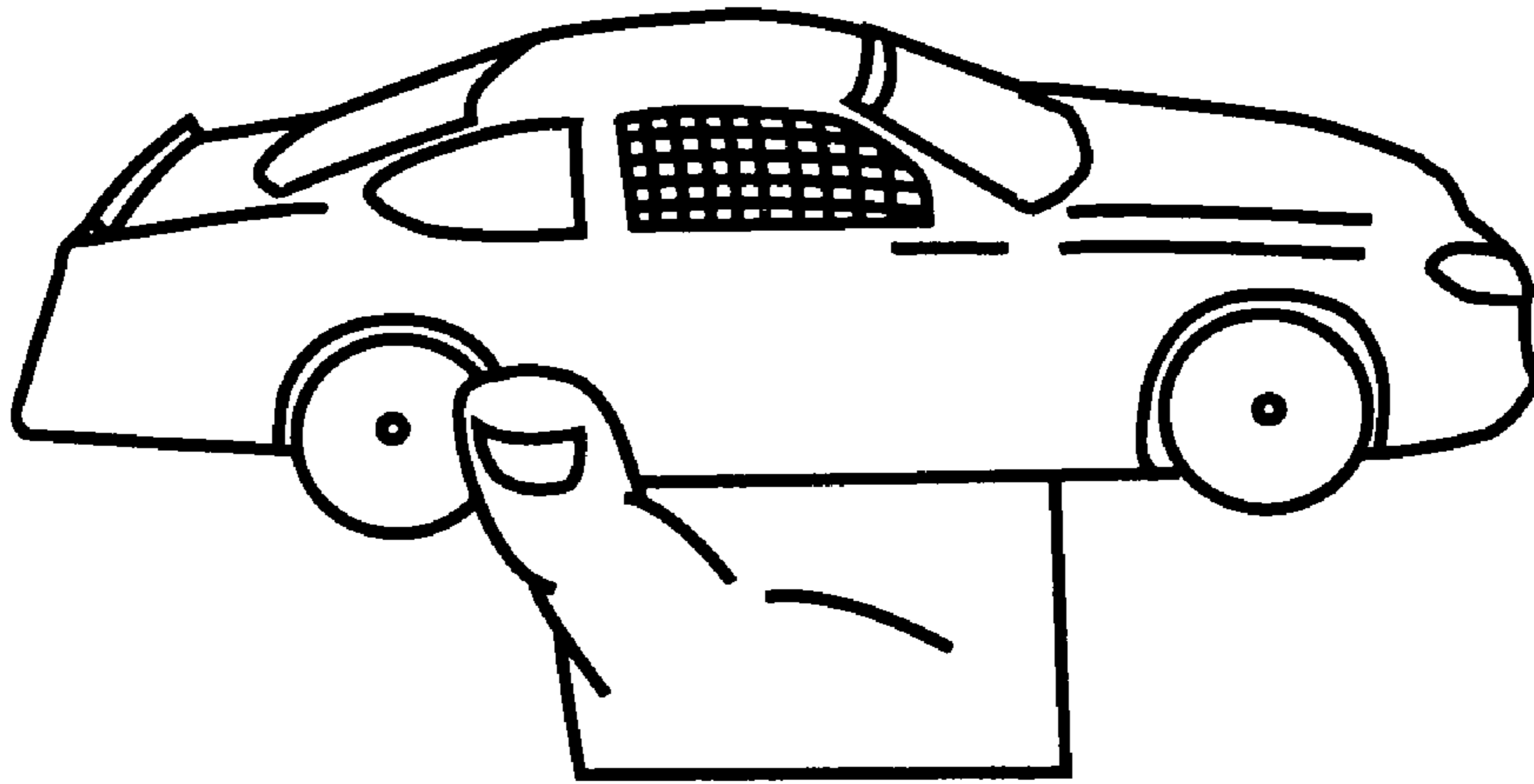

FIG. 1

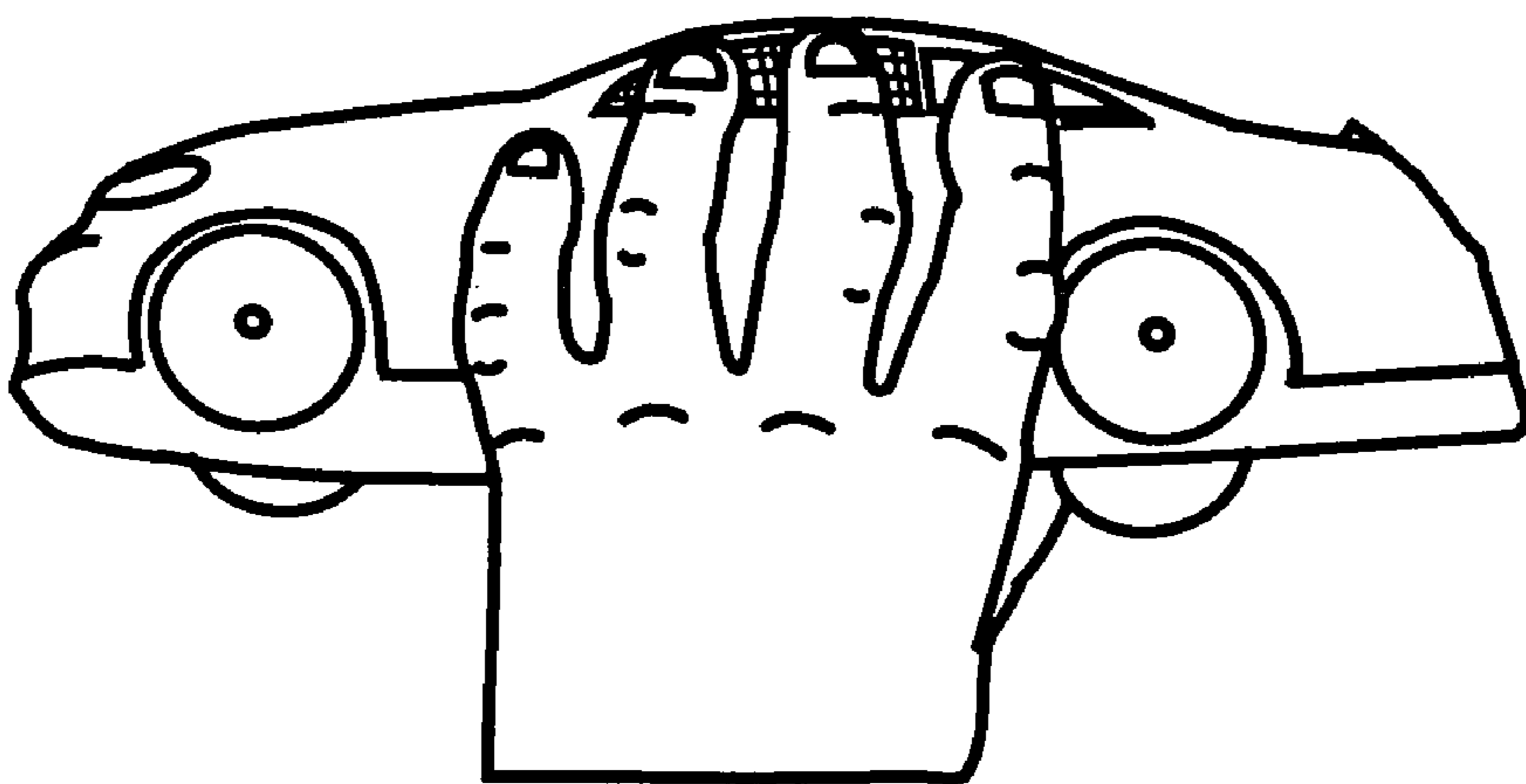

FIG. 2

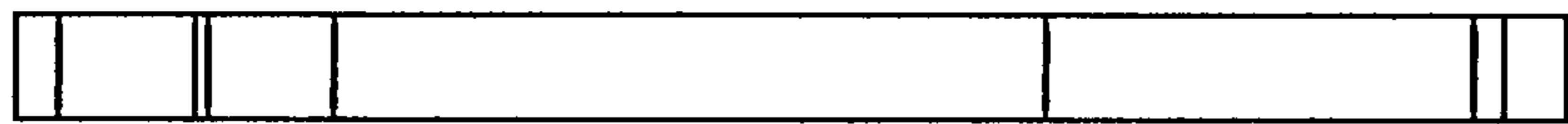

FIG. 4

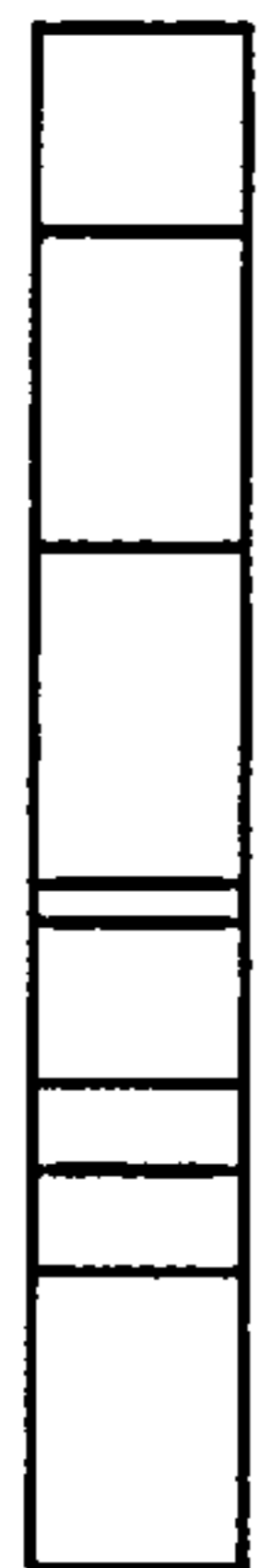

FIG. 3



FIG. 6

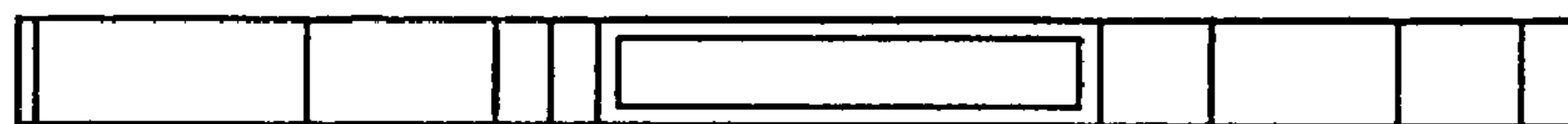

FIG. 5

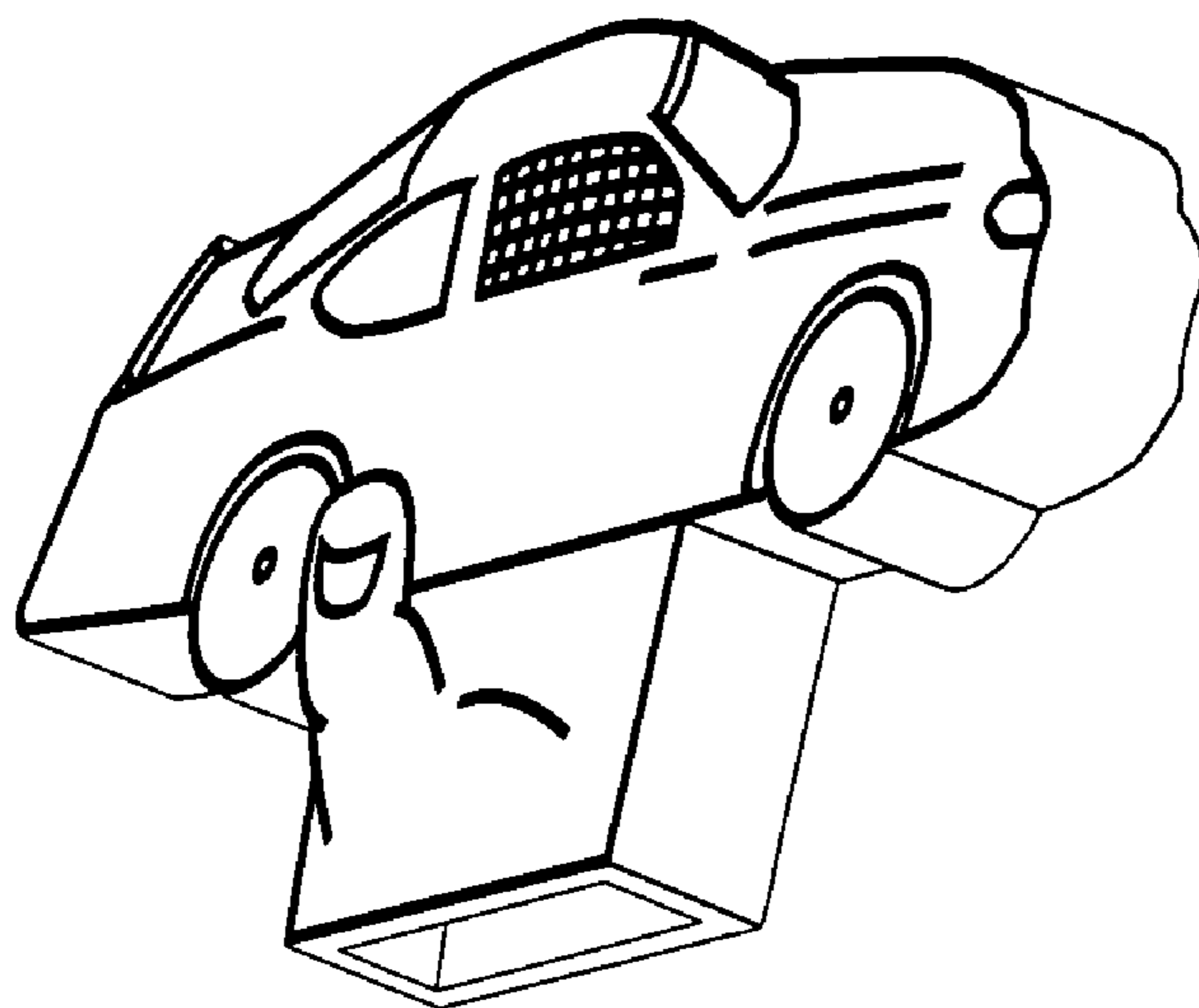

FIG. 7

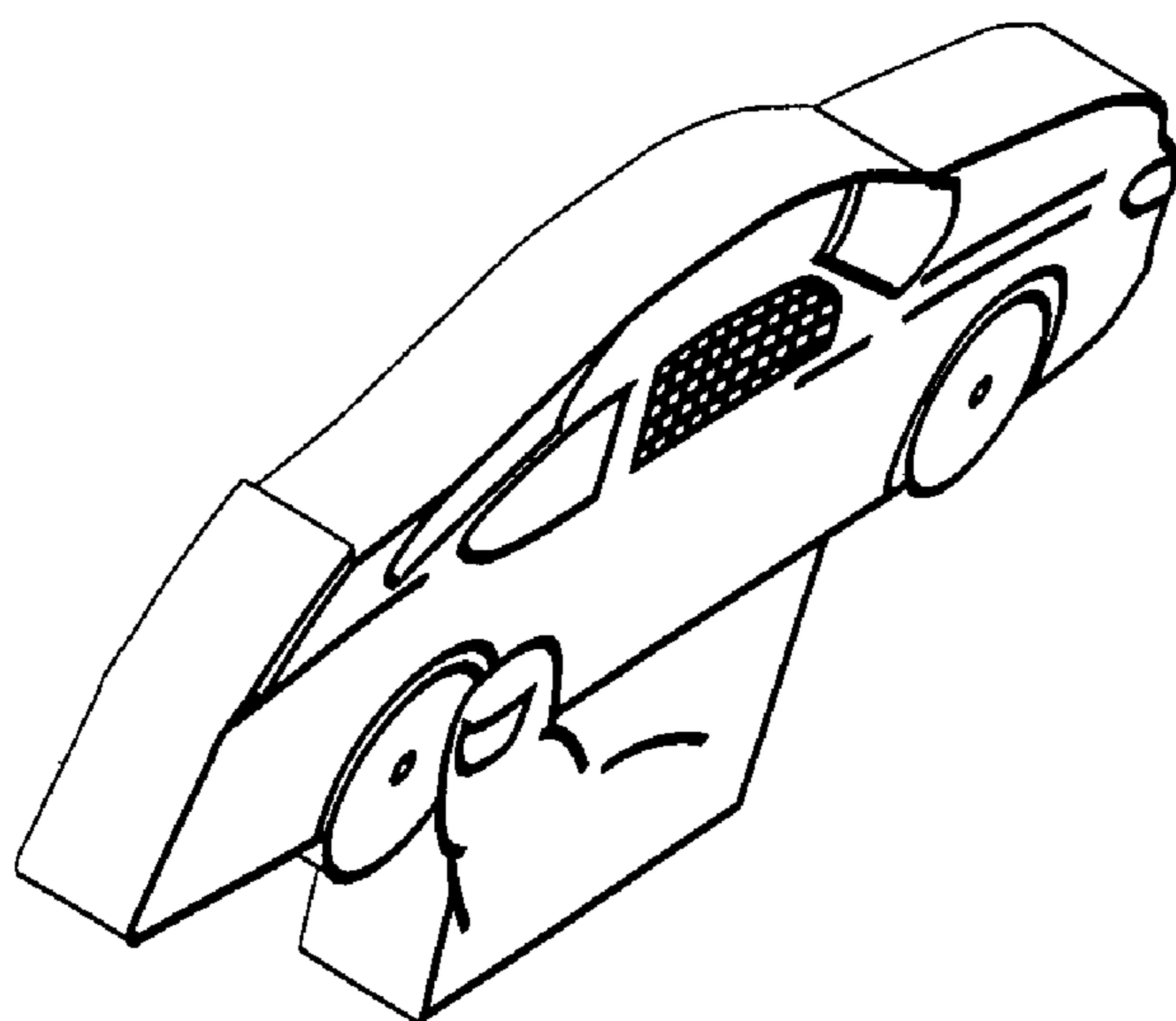

FIG. 8

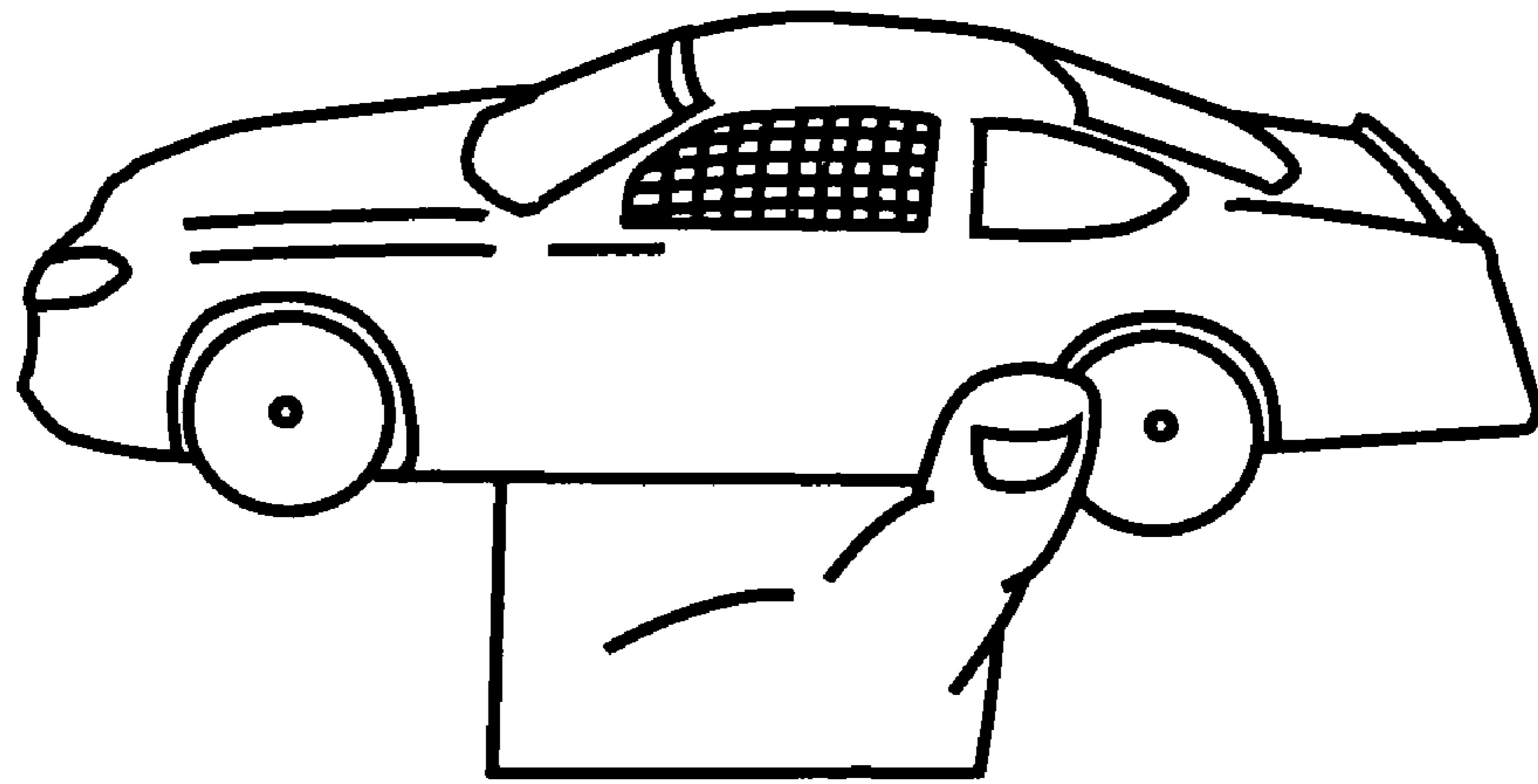

FIG. 9

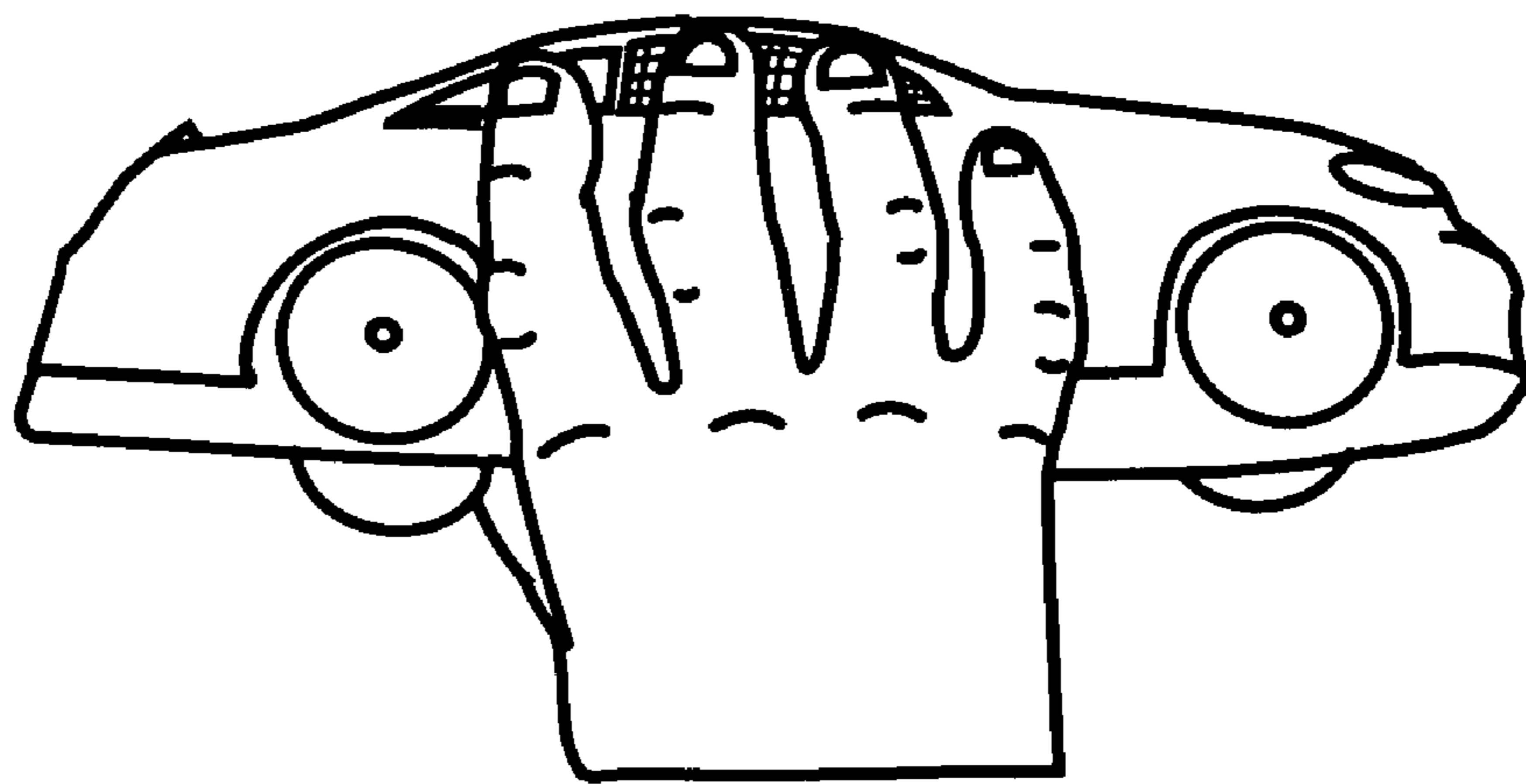

FIG. 10



FIG. 12

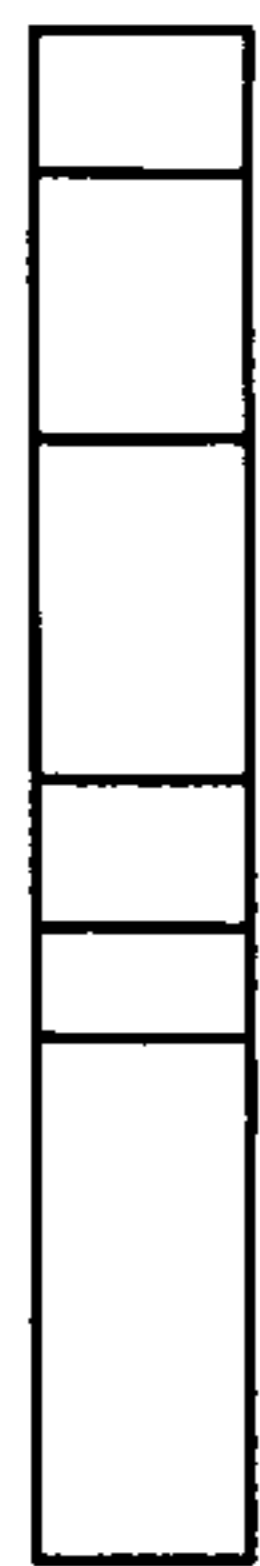

FIG. 11



FIG. 14

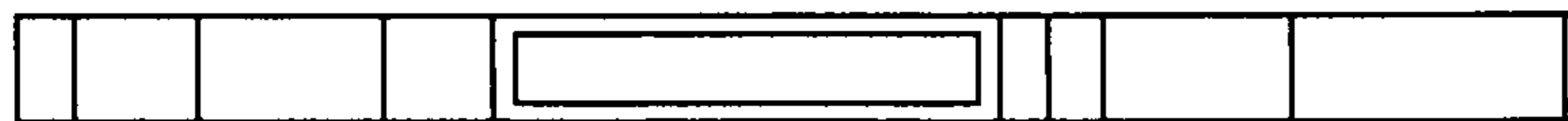

FIG. 13

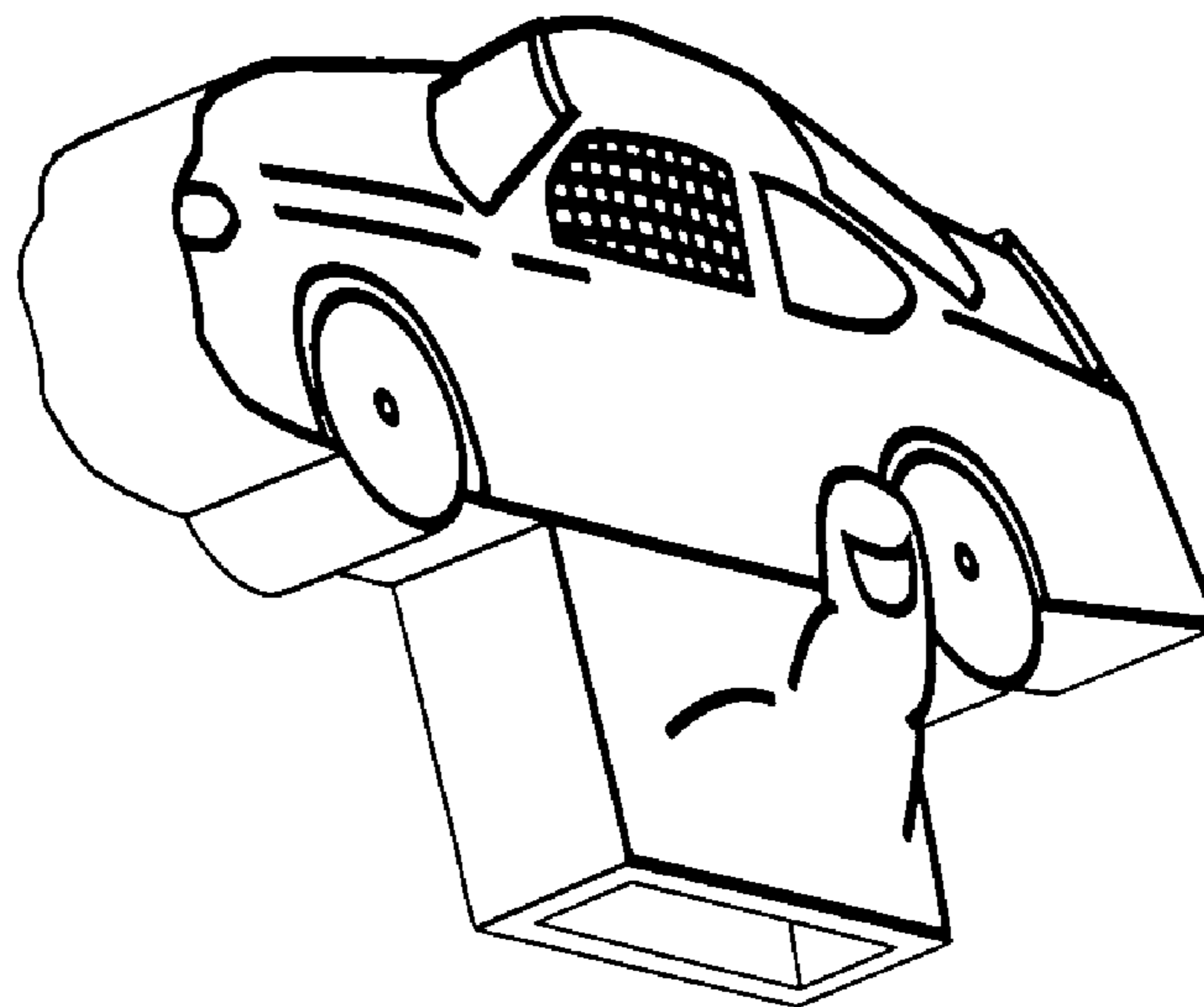

FIG. 15

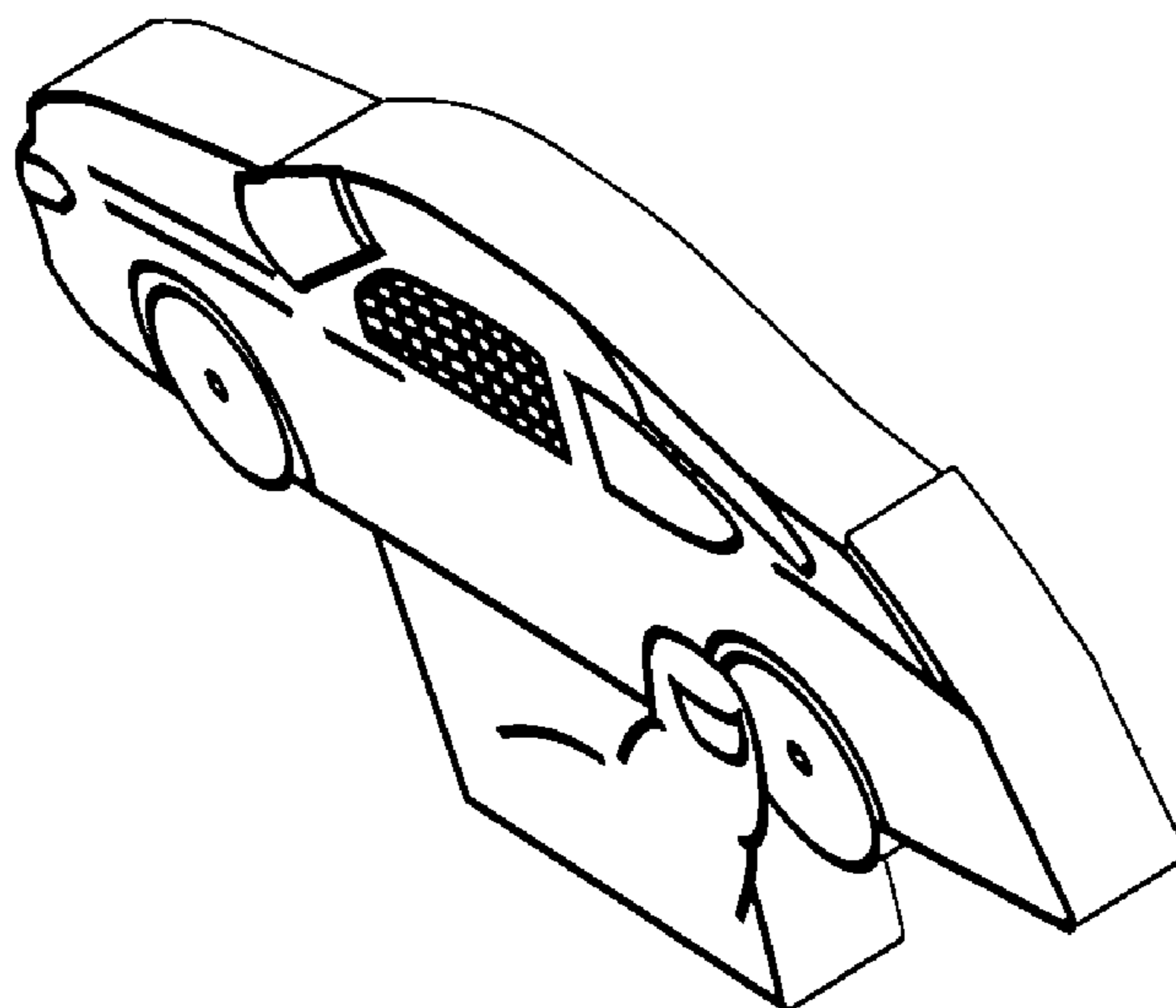

FIG. 16

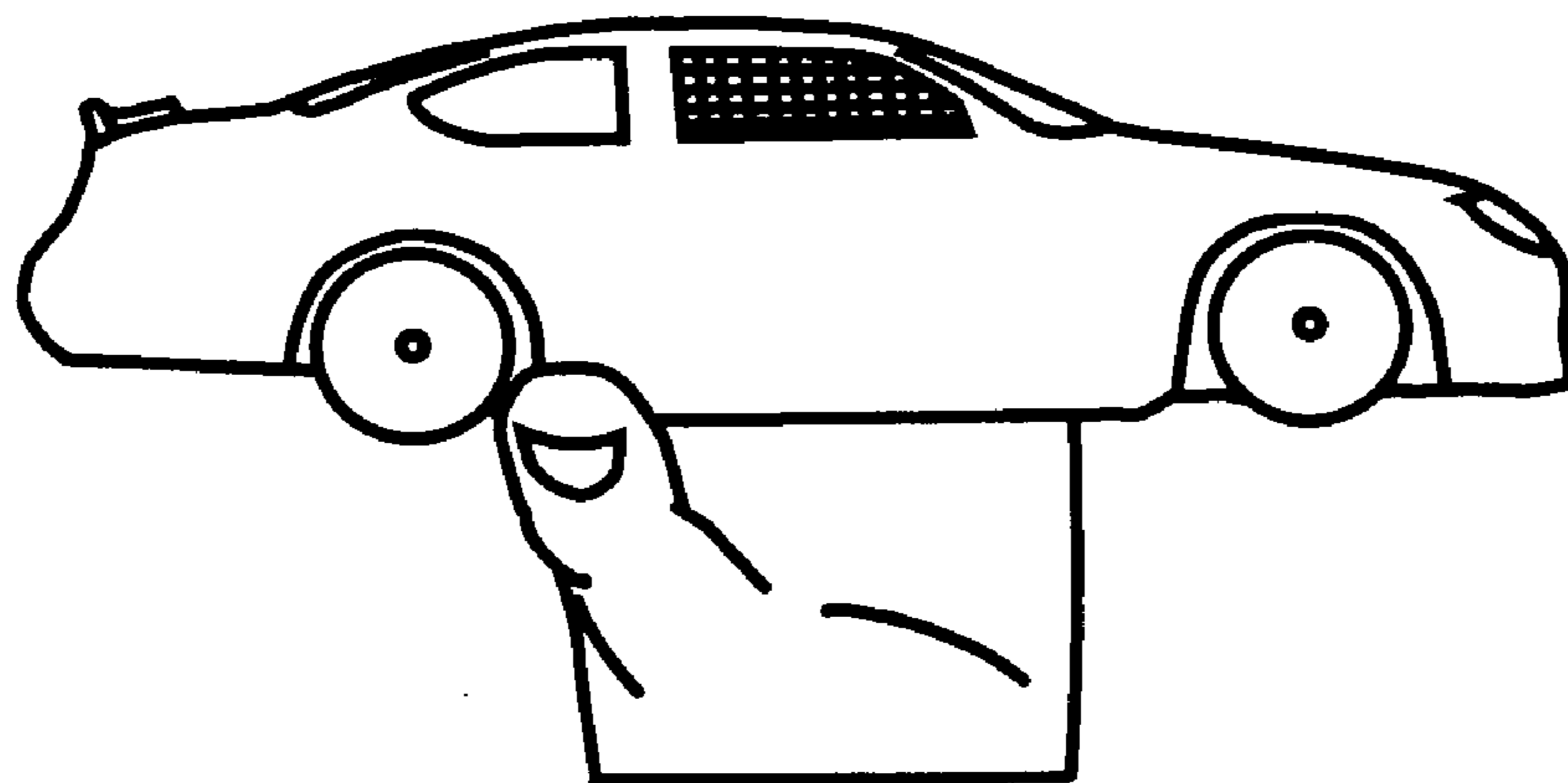

FIG. 17

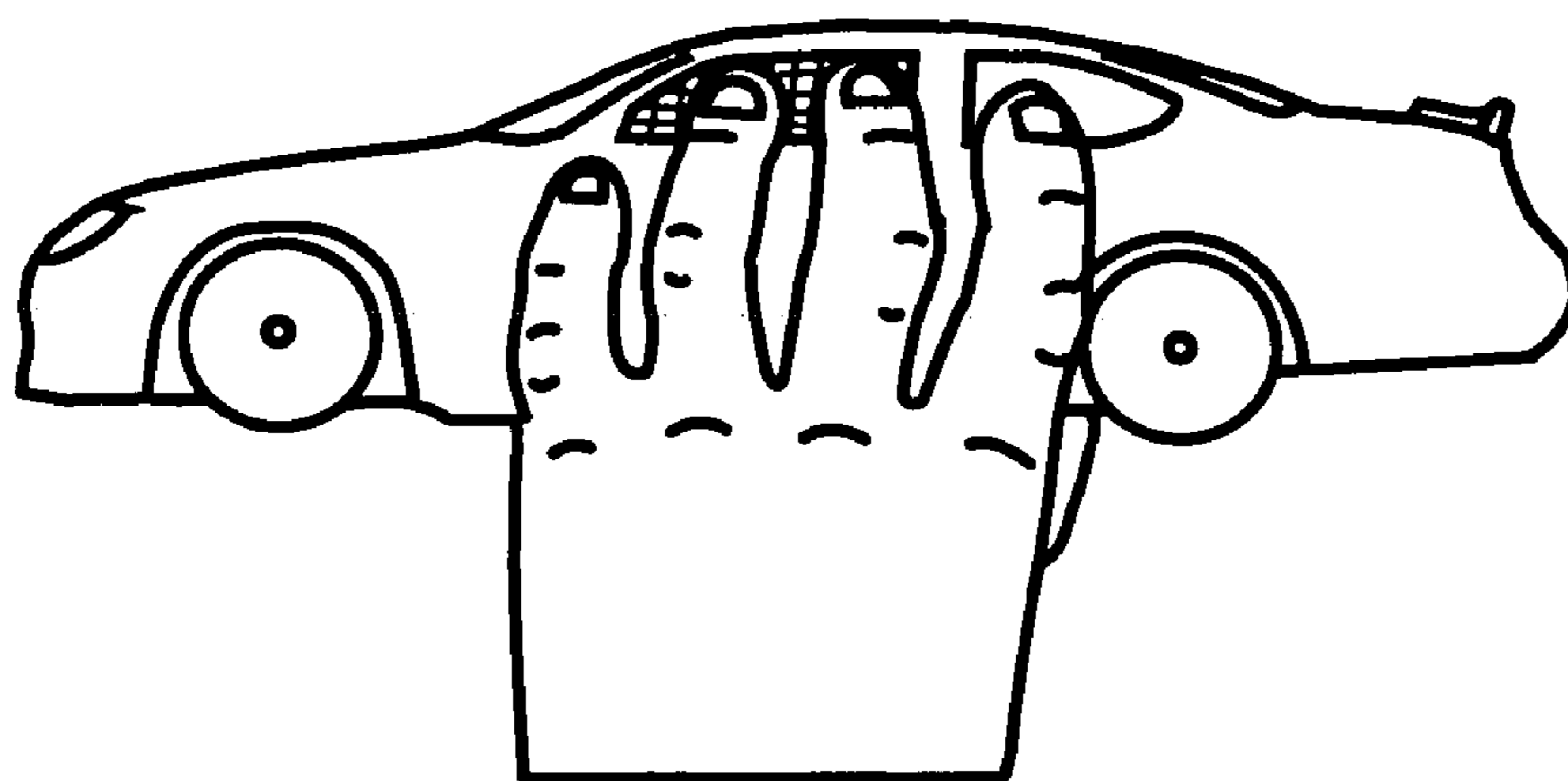

FIG. 18



FIG. 20



FIG. 19



FIG. 22



FIG. 21

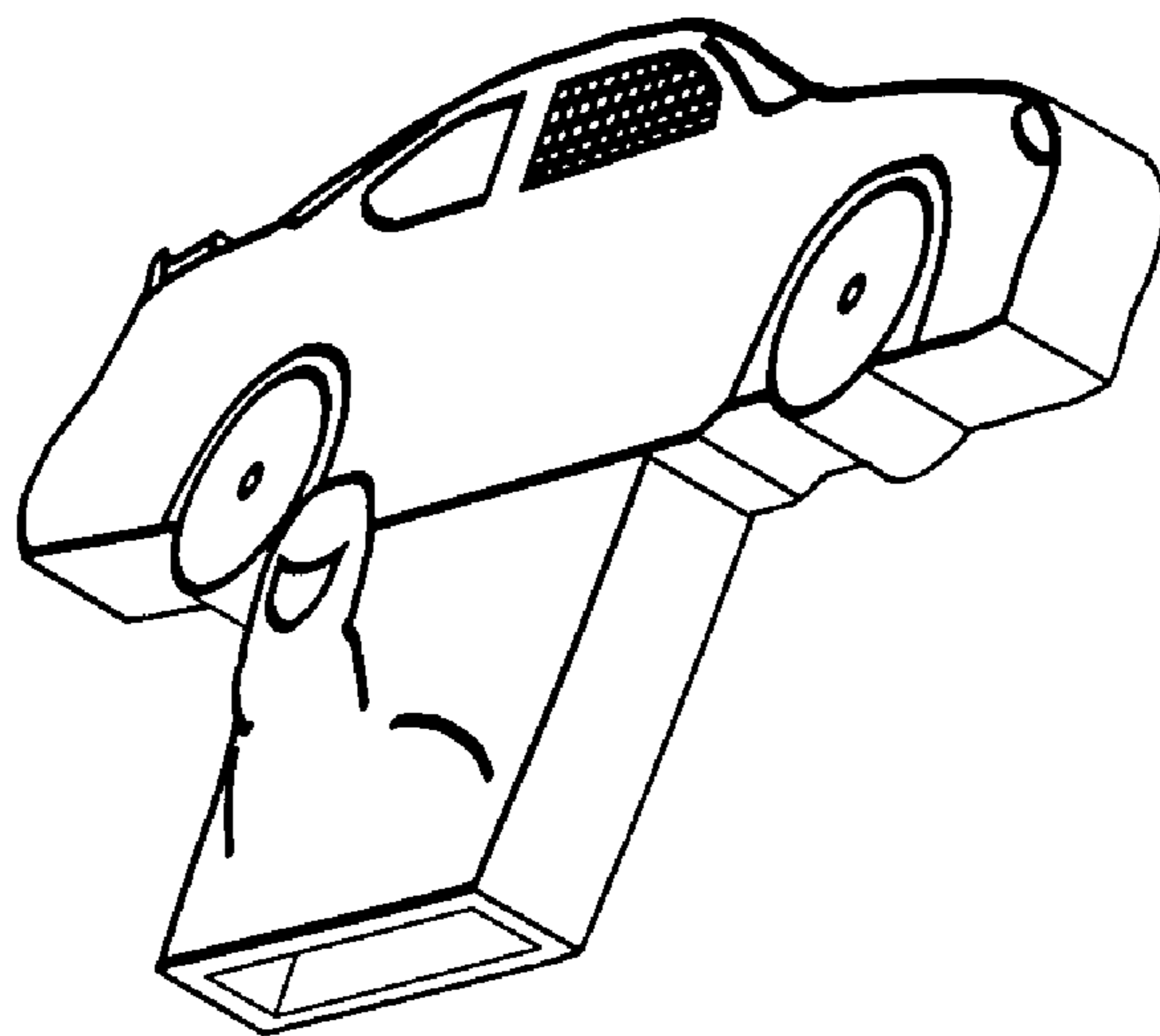

FIG. 23

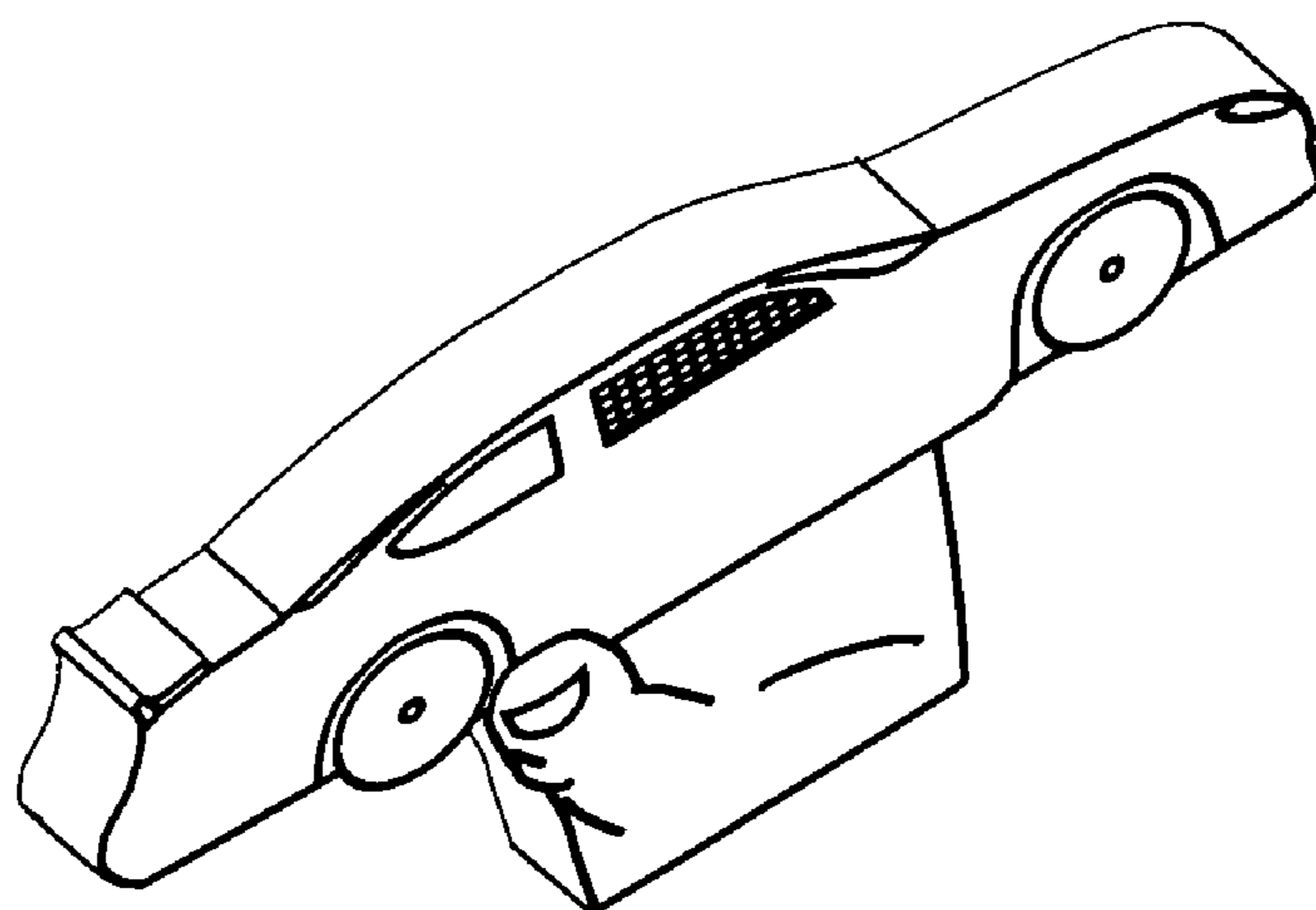

FIG. 24

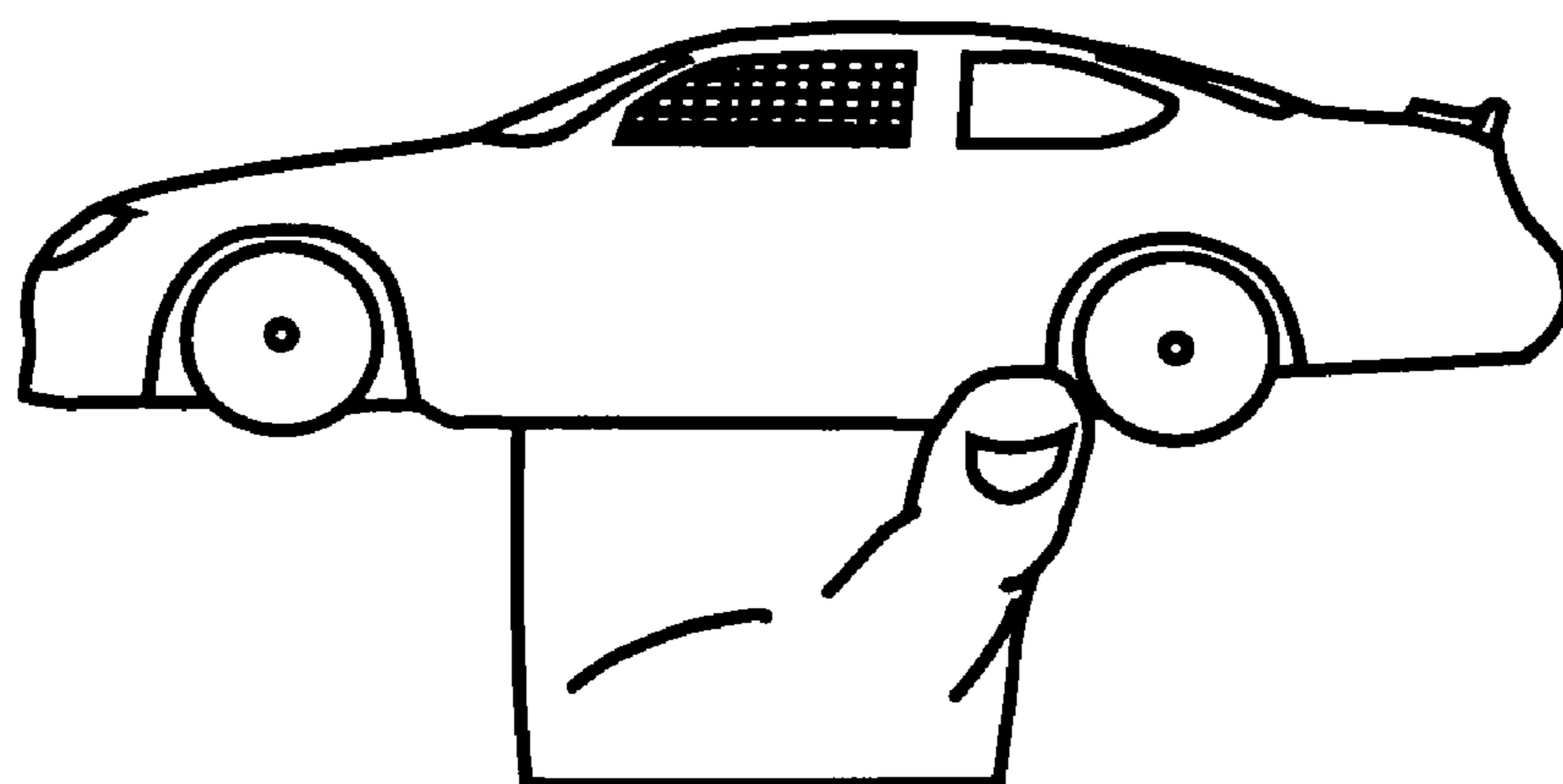

FIG. 25

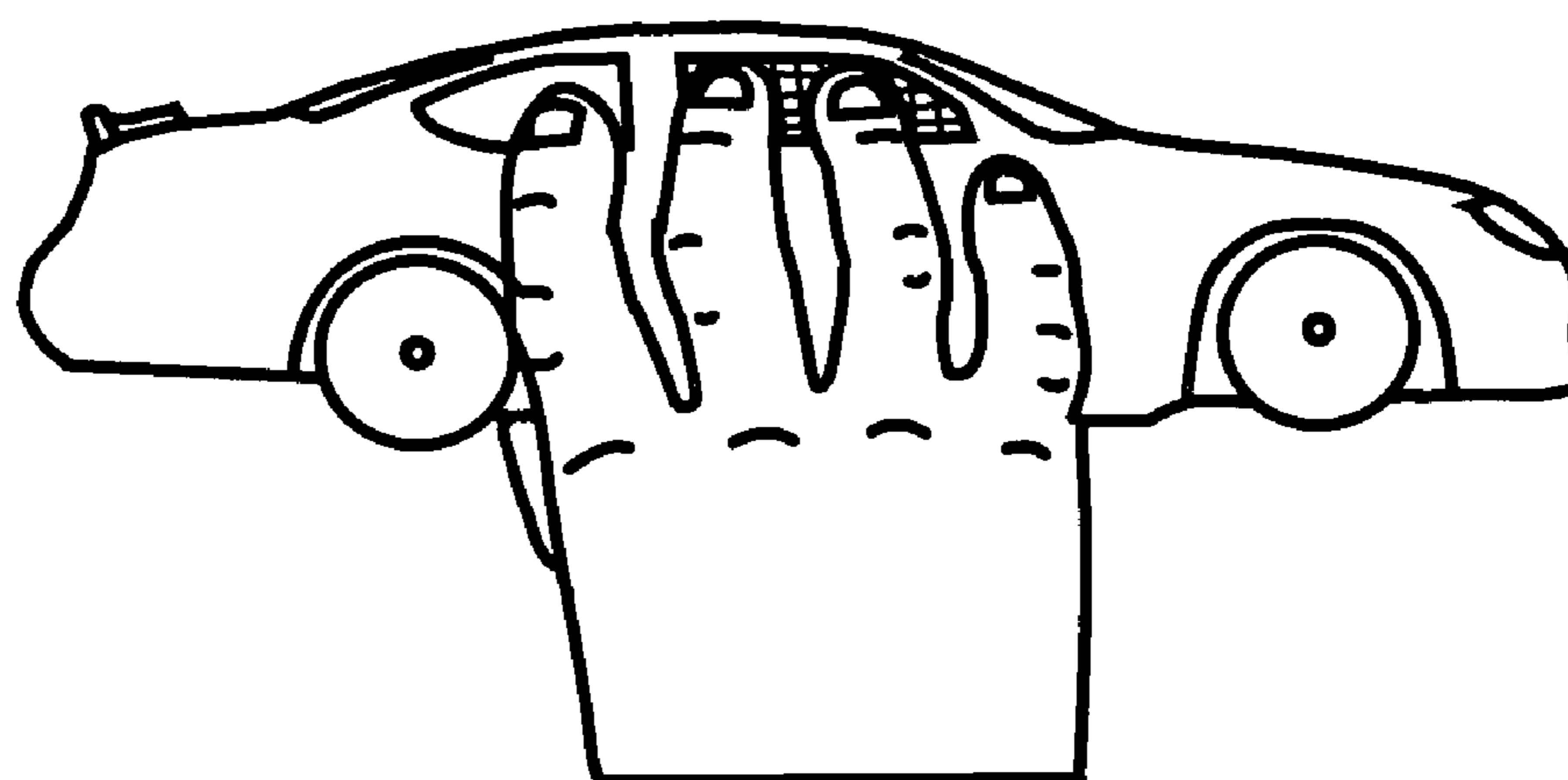

FIG. 26



FIG. 28



FIG. 27



FIG. 30



FIG. 29

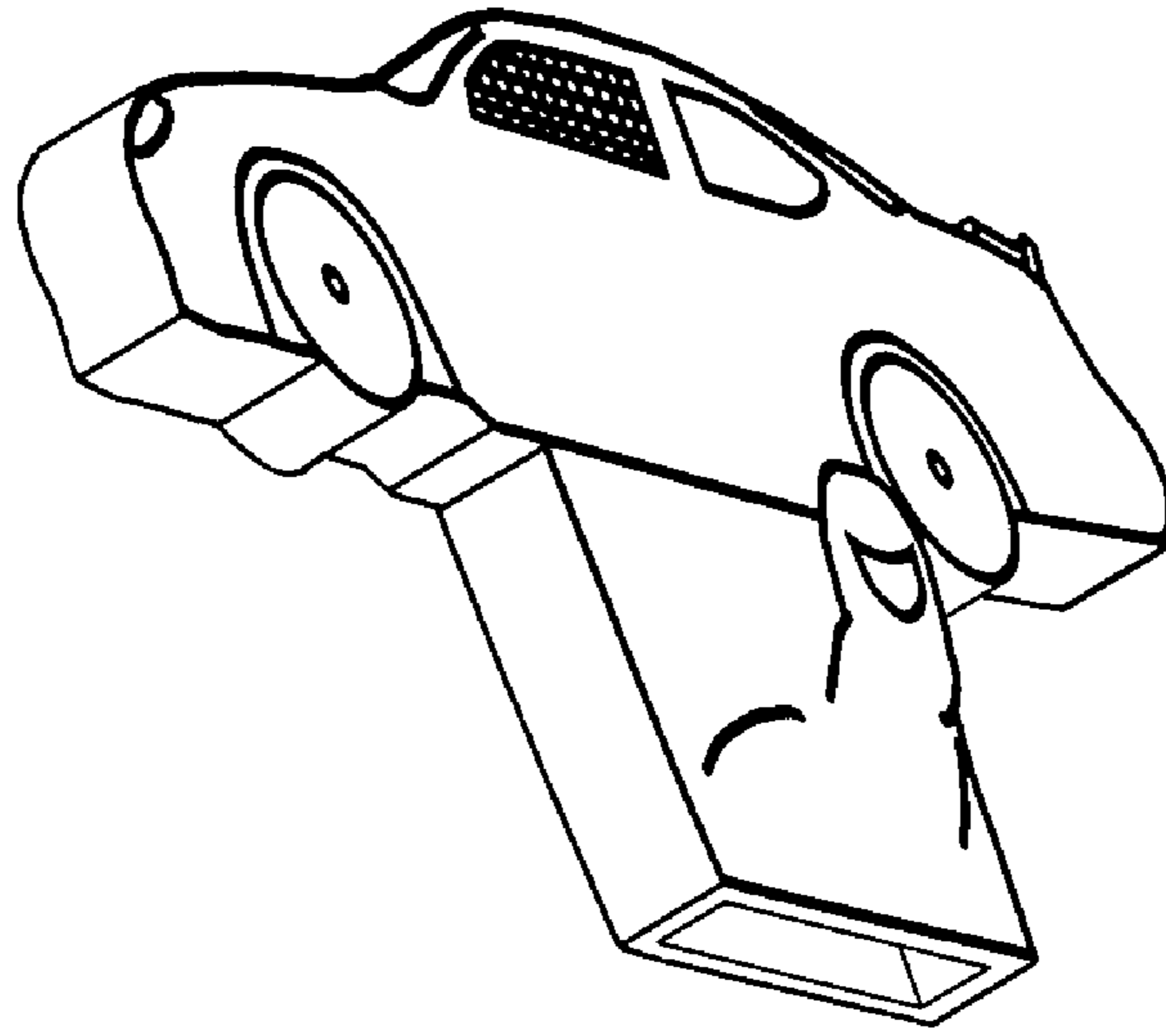

FIG. 31

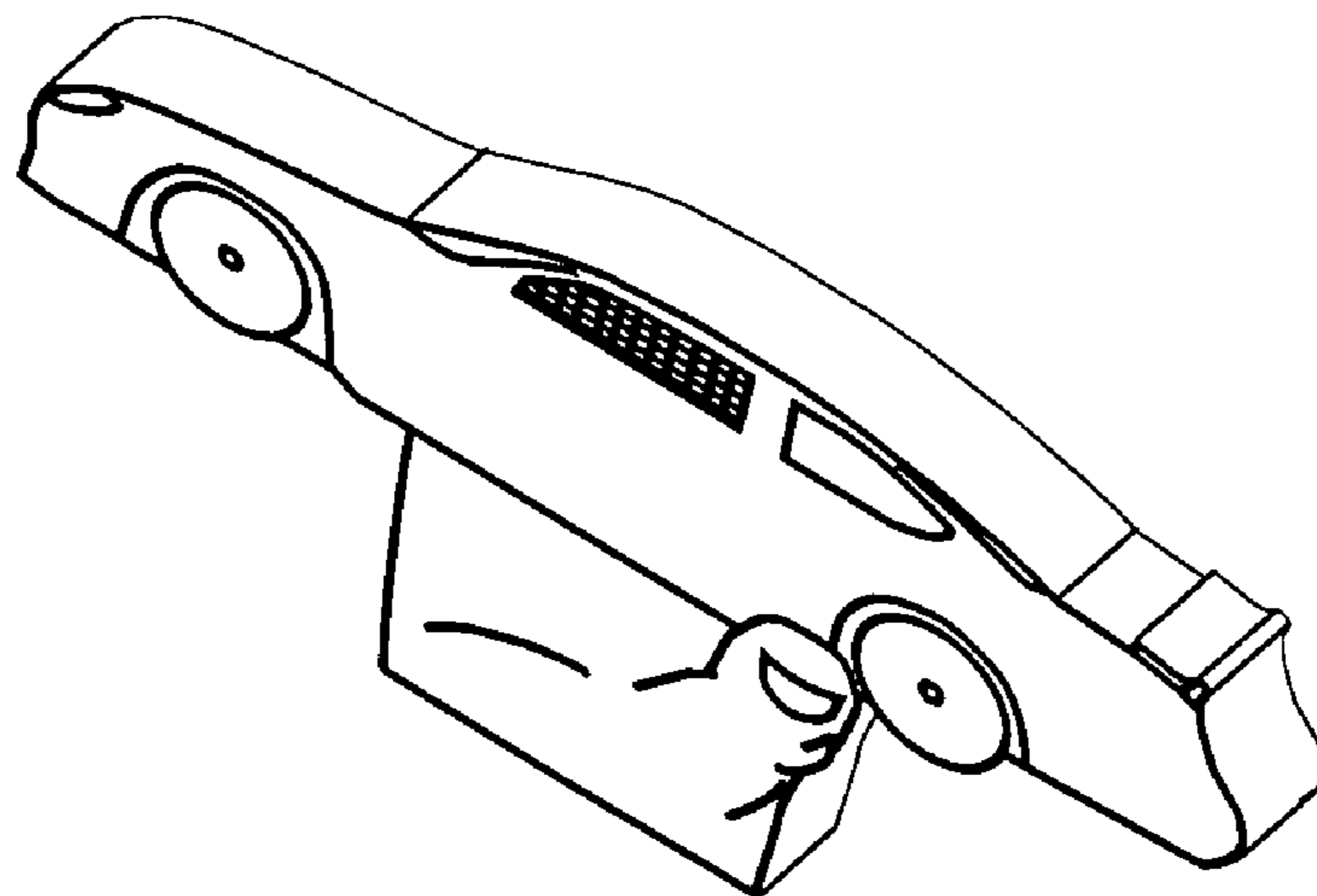

FIG. 32