



US00D679328S

(12) **United States Design Patent**  
**Jiang**

(10) **Patent No.:** **US D679,328 S**

(45) **Date of Patent:** **\*\* Apr. 2, 2013**

(54) **CAP FOR A PEN**

(75) Inventor: **Linghua Jiang**, Ningbo (CN)

(73) Assignee: **Beifa Group Co., Ltd.**, Ningbo (CN)

(\*\*) Term: **14 Years**

(21) Appl. No.: **29/404,336**

(22) Filed: **Oct. 19, 2011**

(30) **Foreign Application Priority Data**

Apr. 29, 2011 (CN) ..... 2011 3 0098877

(51) **LOC (9) Cl.** ..... **19-06**

(52) **U.S. Cl.** ..... **D19/57**

(58) **Field of Classification Search** ..... D14/411;  
D19/35, 36, 41-51, 54-58; 24/11 F, 11 P,  
24/11 R; 401/52, 99-109, 192, 195, 196  
See application file for complete search history.

(56) **References Cited**

**U.S. PATENT DOCUMENTS**

D409,661 S	5/1999	Izushima	
D418,164 S *	12/1999	Izushima	D19/57
D465,519 S *	11/2002	Kennedy et al.	D19/43
D483,067 S *	12/2003	Takanashi	D19/43
D487,776 S	3/2004	Keda	
D499,762 S *	12/2004	Shova et al.	D19/43
D501,512 S *	2/2005	Shova et al.	D19/66
D502,219 S *	2/2005	Shova et al.	D19/57
D502,739 S *	3/2005	Shova et al.	D19/66

D509,536 S	9/2005	Nishida	
D549,777 S *	8/2007	Soetewey	D19/51
D552,674 S *	10/2007	Qiu et al.	D19/48
D552,675 S *	10/2007	Zhang	D19/48
D562,384 S *	2/2008	Qiu	D19/36
D562,395 S *	2/2008	Qiu et al.	D19/51
D569,437 S	5/2008	Shimizu	
D616,025 S *	5/2010	Yan	D19/51
D669,129 S *	10/2012	Liang	D19/57

\* cited by examiner

*Primary Examiner* — Elizabeth Albert

(74) *Attorney, Agent, or Firm* — Christensen O'Connor Johnson Kindness PLLC

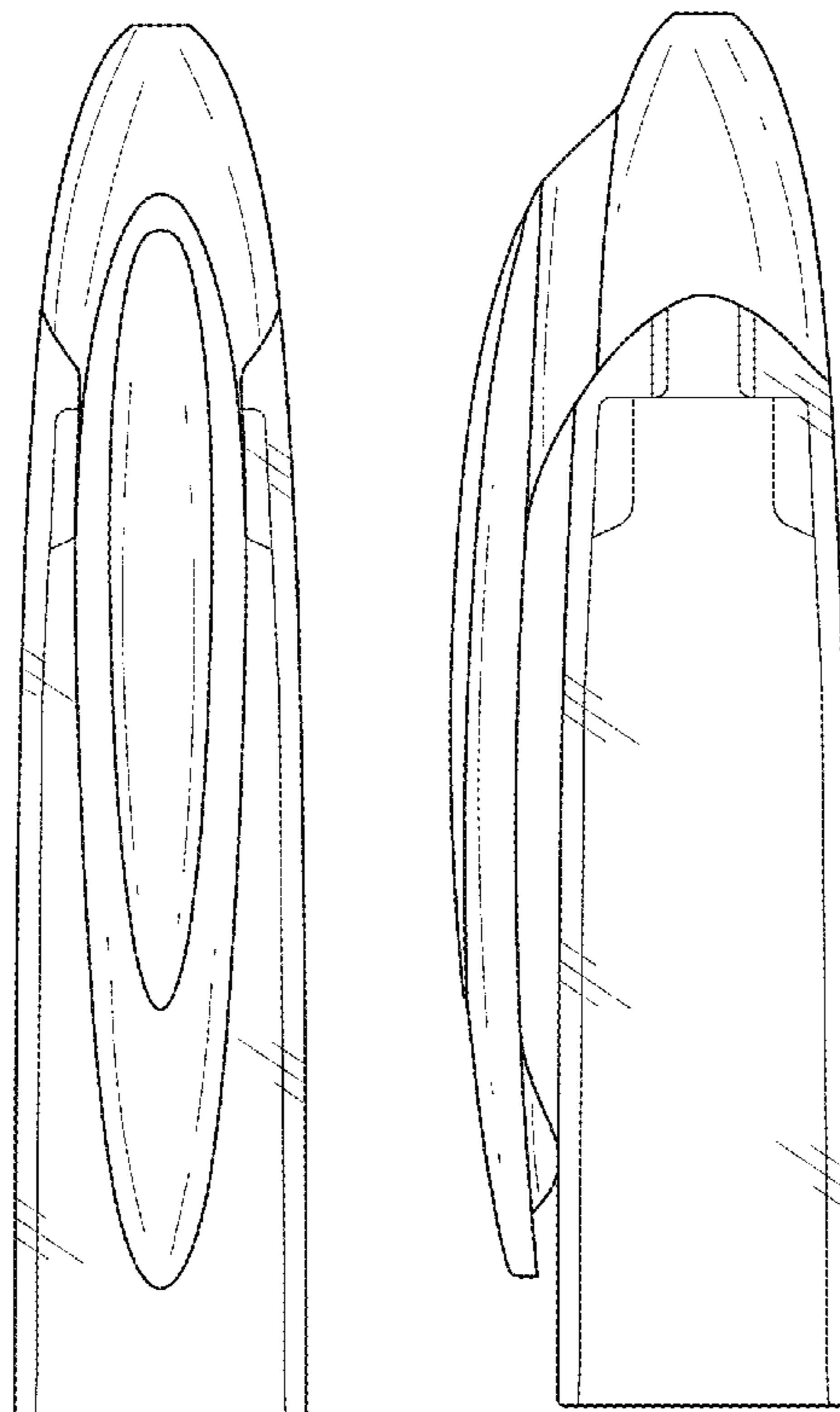
(57) **CLAIM**

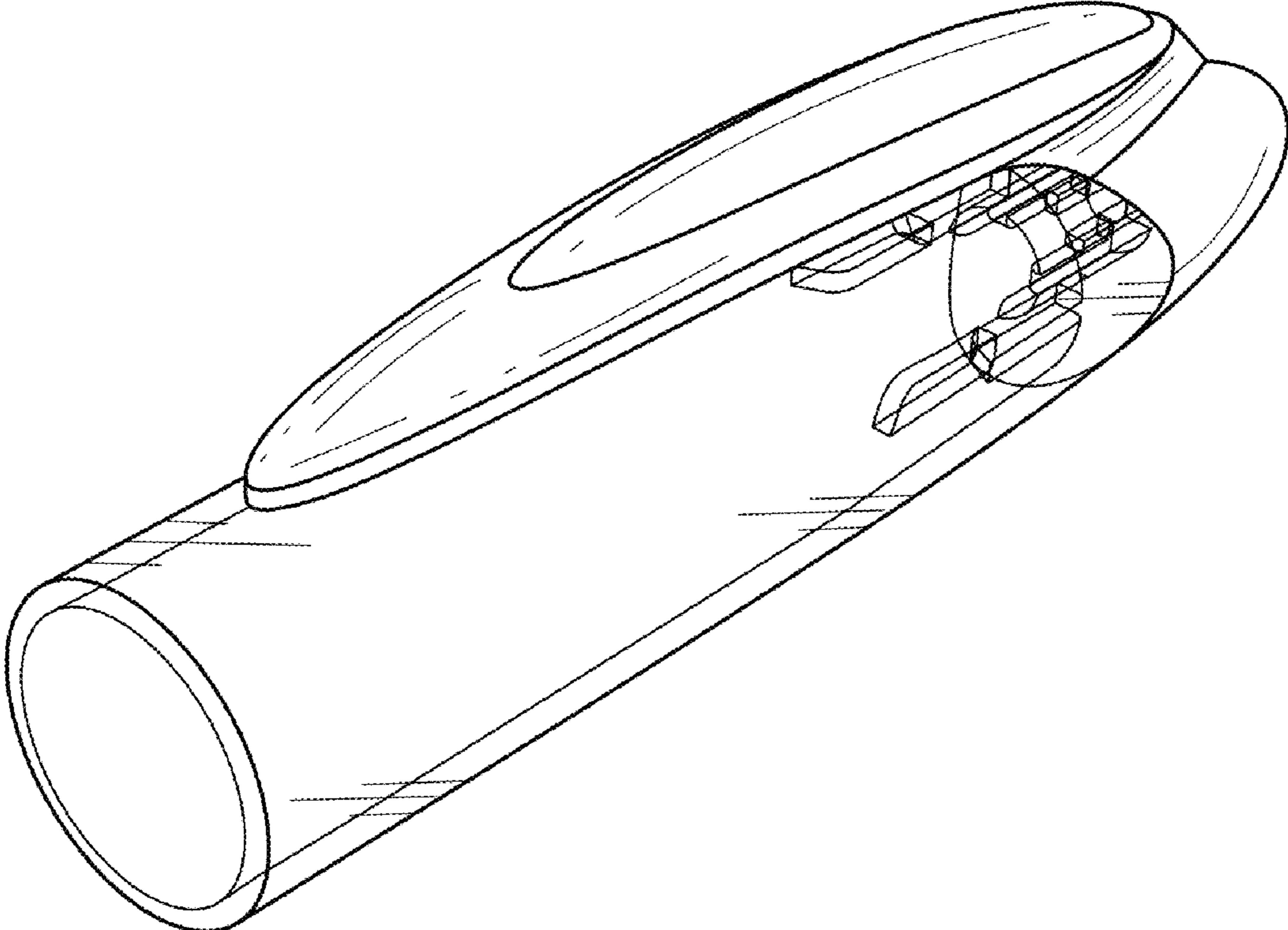
The ornamental design for a cap for a pen, as shown and described.

**DESCRIPTION**

FIG. 1 is a lower front right perspective view of a cap for a pen showing my new design;  
FIG. 2 is a front elevation view thereof;  
FIG. 3 is a rear elevation view thereof;  
FIG. 4 is a right side elevation view thereof, with the left side elevation view being a mirror image of the right side elevation view;  
FIG. 5 is a top plan view thereof; and,  
FIG. 6 is a bottom plan view thereof.  
The broken lines shown in FIG. 5 illustrate environmental subject matter and form no part of the claimed design.

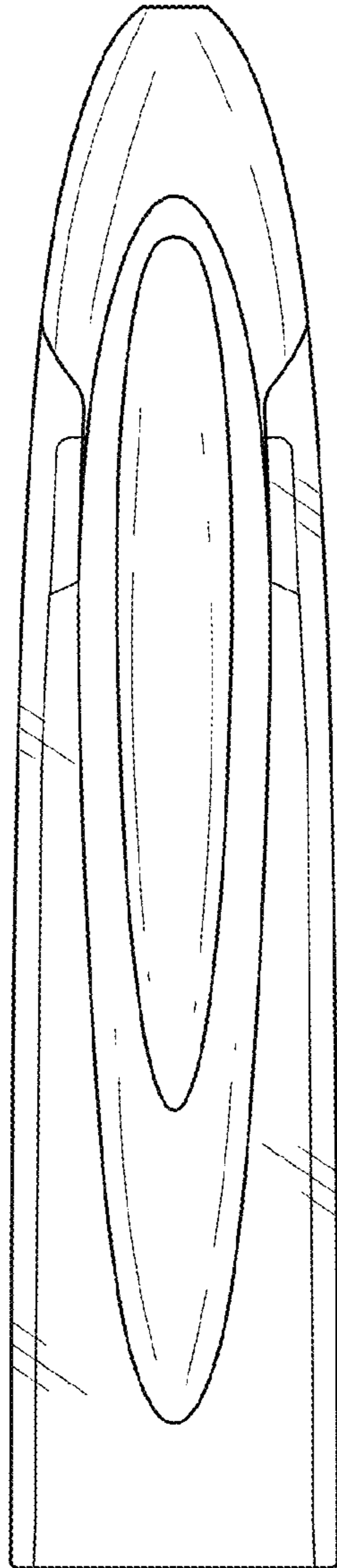
**1 Claim, 4 Drawing Sheets**



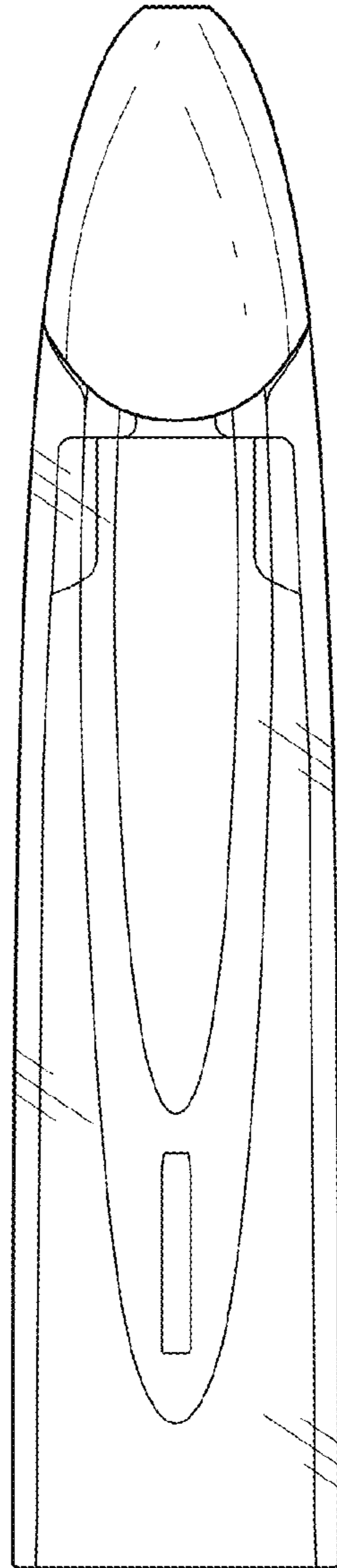


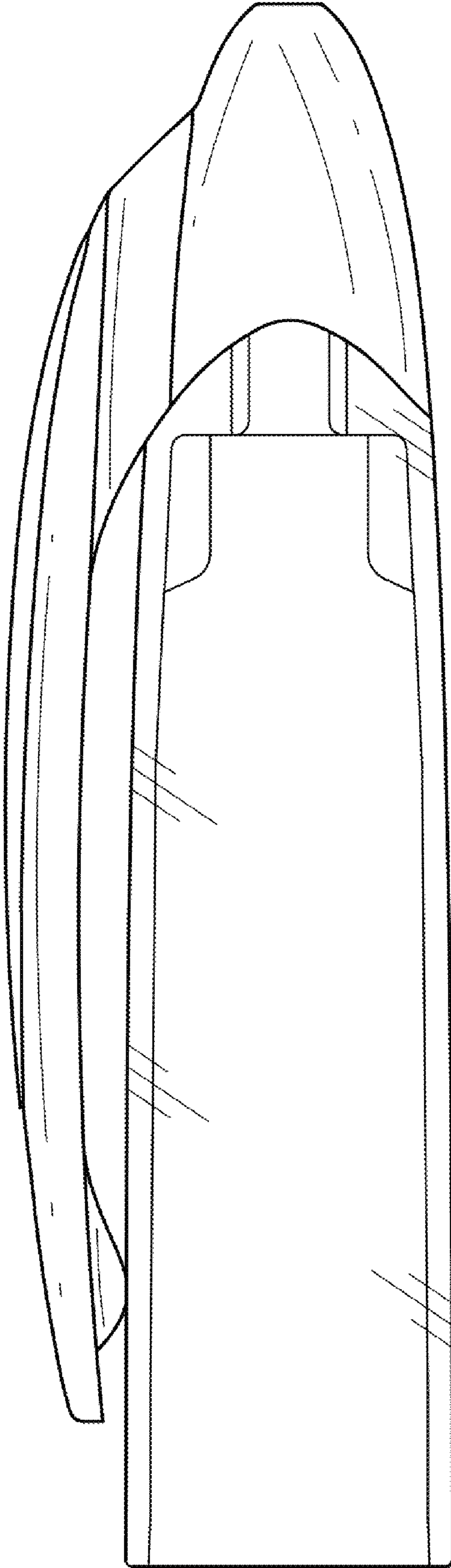
*Fig. 1*

*Fig.2*

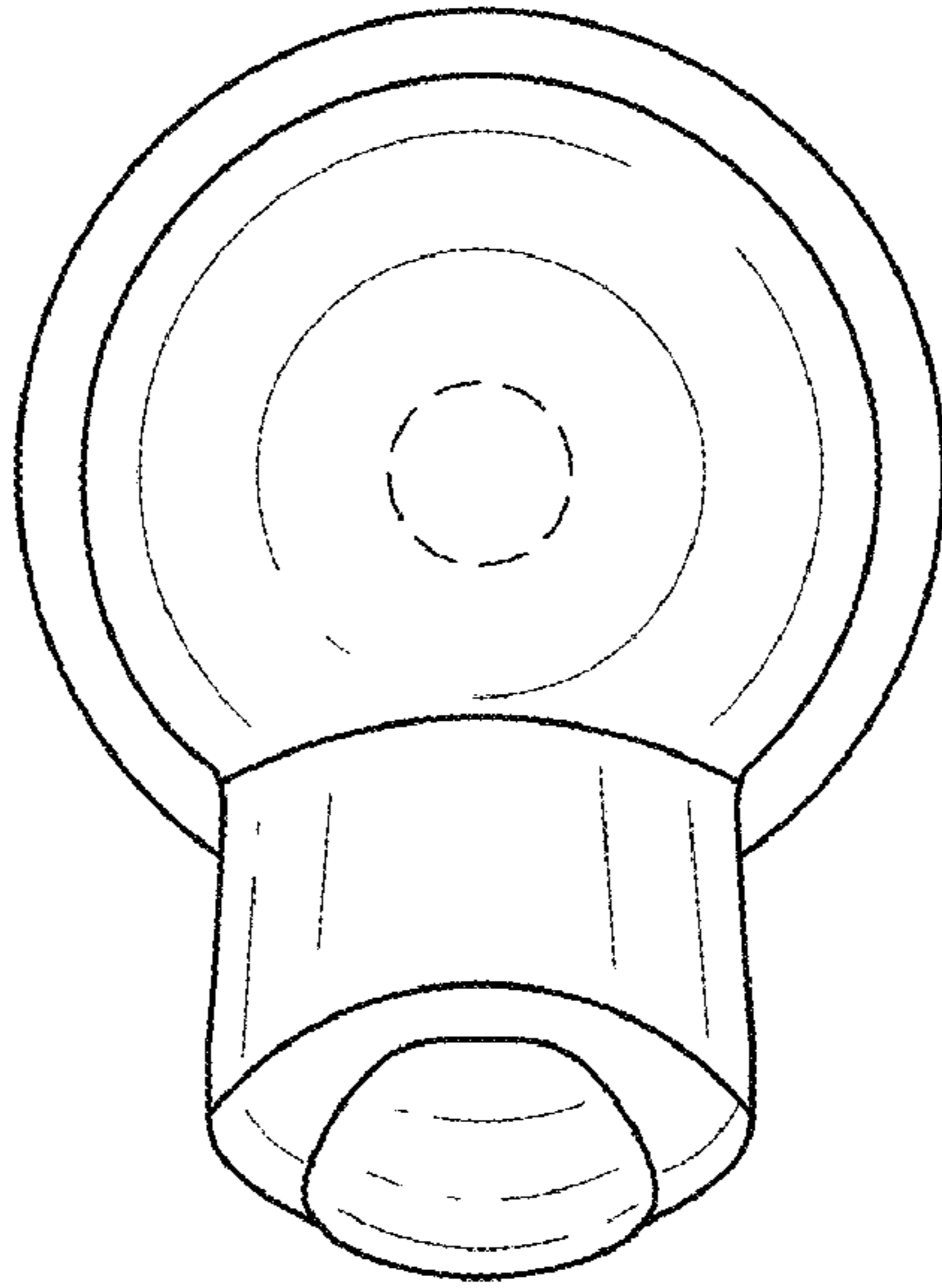


*Fig.3*

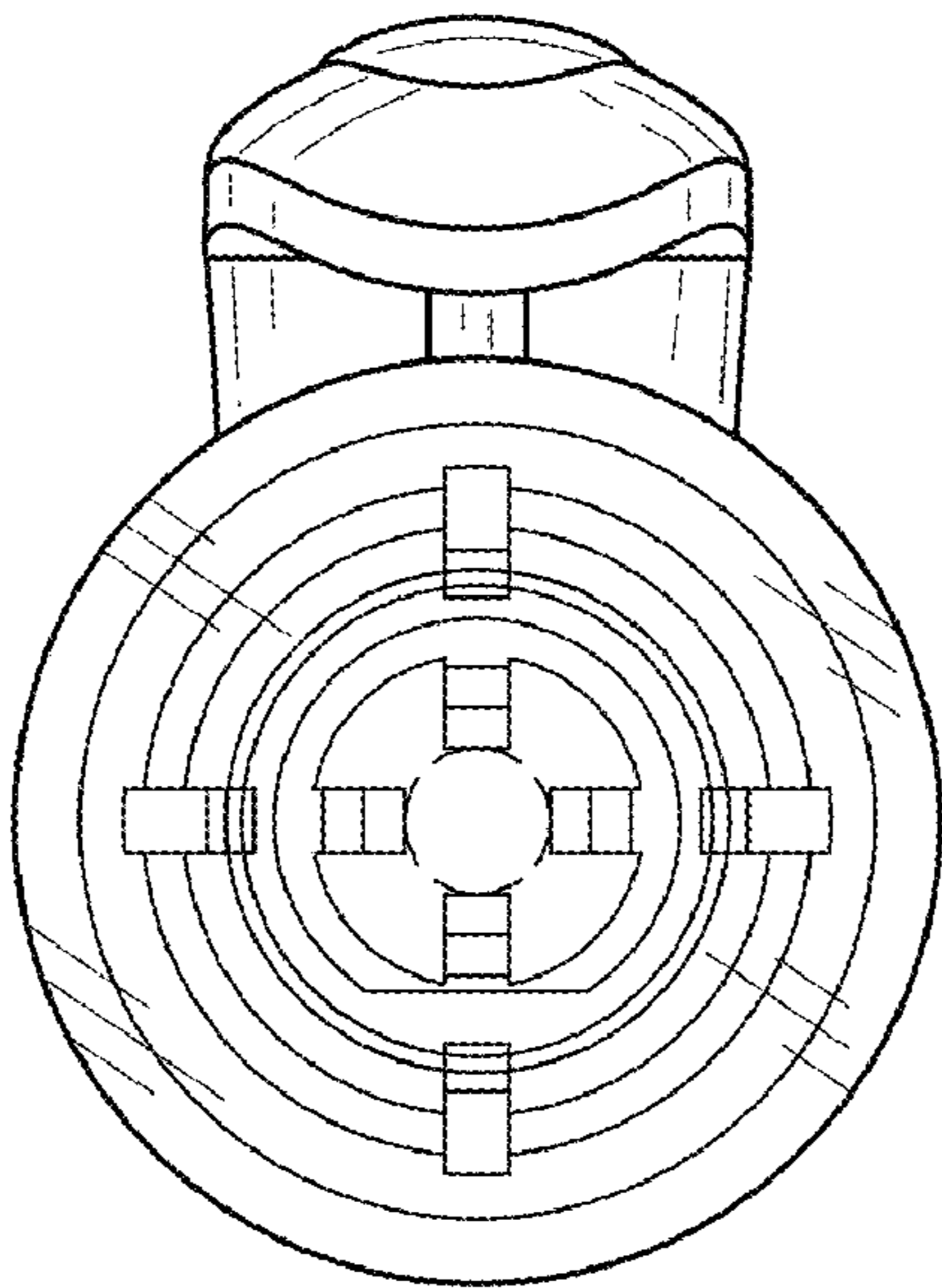




*Fig. 4*



*Fig. 5*



*Fig. 6*