



US00D679243S

(12) **United States Design Patent**
Chilton et al.

(10) **Patent No.:** **US D679,243 S**

(45) **Date of Patent:** **** Apr. 2, 2013**

(54) **SOLAR PANEL CASING**

(75) Inventors: **Robin Blake Kiran Chilton**, London (GB); **Xianyi Wu**, Singapore (SG); **Sean Sun**, Shenzhen (CN)

(73) Assignee: **D.Light Design, Inc.**, Grand Cayman (KY)

(**) Term: **14 Years**

(21) Appl. No.: **29/423,448**

(22) Filed: **May 31, 2012**

(51) **LOC (9) Cl.** **13-02**

(52) **U.S. Cl.** **D13/102**

(58) **Field of Classification Search** D13/102, D13/101, 103, 107, 108, 199; 136/206, 243, 136/244, 245, 252; 320/101, 102, 114, 115, 320/120

See application file for complete search history.

(56) **References Cited**

U.S. PATENT DOCUMENTS

4,786,851	A *	11/1988	Fuji et al.	320/101
5,522,943	A *	6/1996	Spencer et al.	136/245
D391,921	S *	3/1998	Zimmer et al.	D13/102
D395,279	S *	6/1998	Peress et al.	D13/107

6,476,311	B1 *	11/2002	Lee et al.	136/244
D489,680	S *	5/2004	Stobart	D13/107
D559,174	S *	1/2008	Sharma et al.	D13/102
D578,961	S *	10/2008	Fisher et al.	D13/108
D610,080	S *	2/2010	Kawakami et al.	D13/102
D620,431	S *	7/2010	Sasada et al.	D13/102
D647,048	S *	10/2011	Sasada et al.	D13/102

* cited by examiner

Primary Examiner — Derrick Holland

(74) *Attorney, Agent, or Firm* — Morgan, Lewis & Bockius LLP

(57) **CLAIM**

The ornamental design for a solar panel casing, as shown and described.

DESCRIPTION

FIG. 1 is a front-top perspective view of a solar panel casing showing our new design;

FIG. 2 is a top view thereof;

FIG. 3 is a bottom view thereof;

FIG. 4 is a side view thereof;

FIG. 5 is a front view thereof; and,

FIG. 6 is a back view thereof.

The broken lines shown represent unclaimed subject matter and form no part of the claimed design.

1 Claim, 6 Drawing Sheets

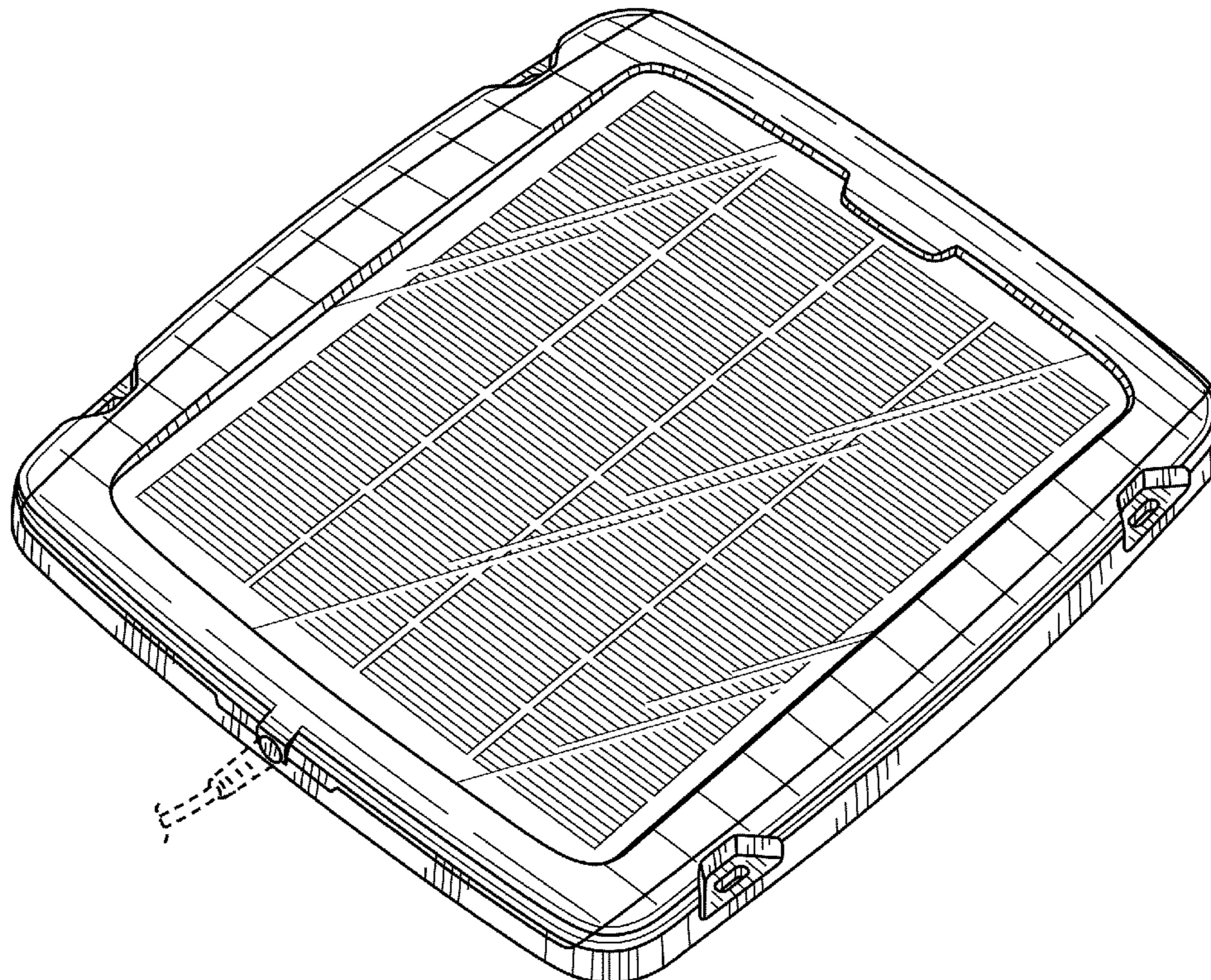

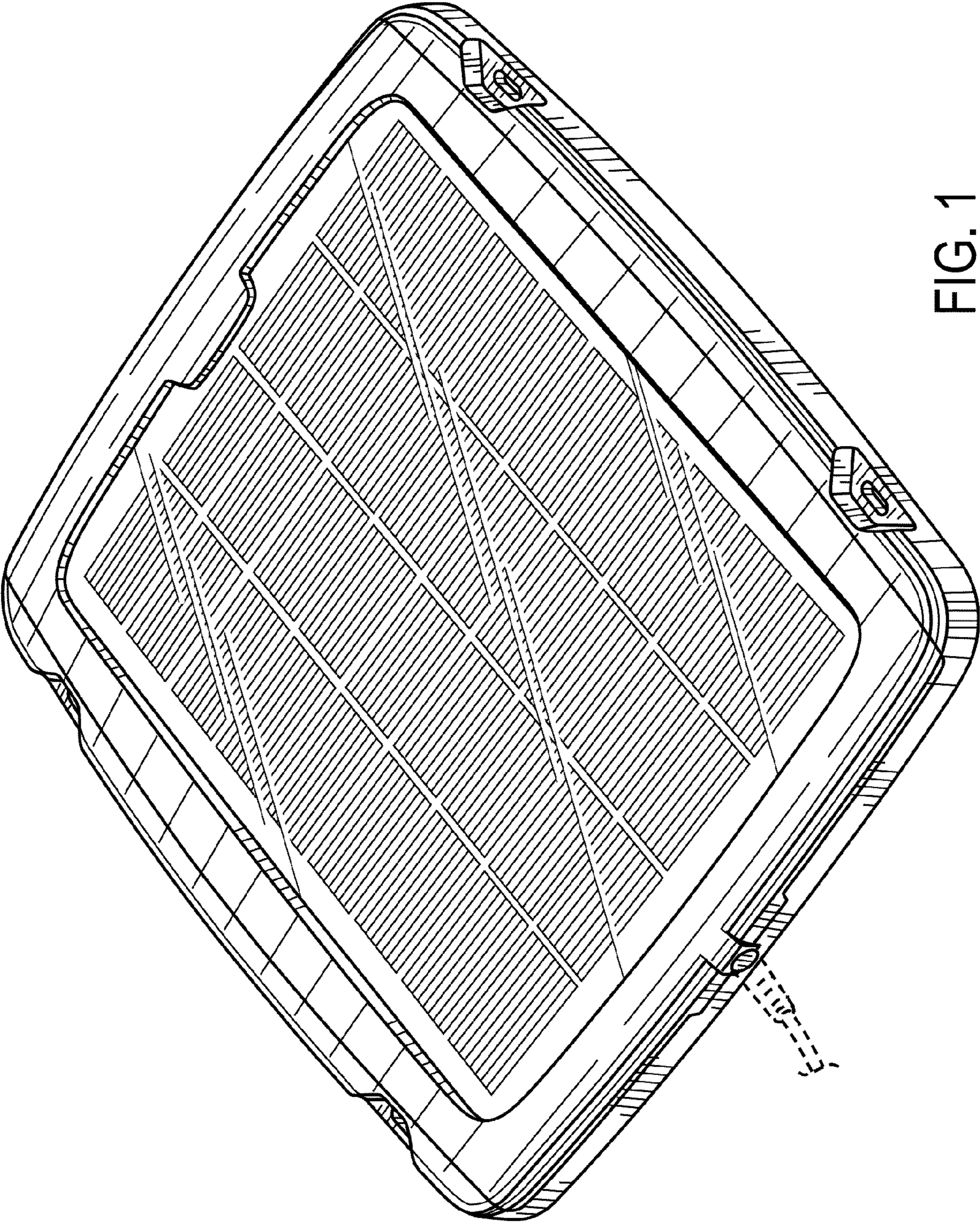

FIG. 1

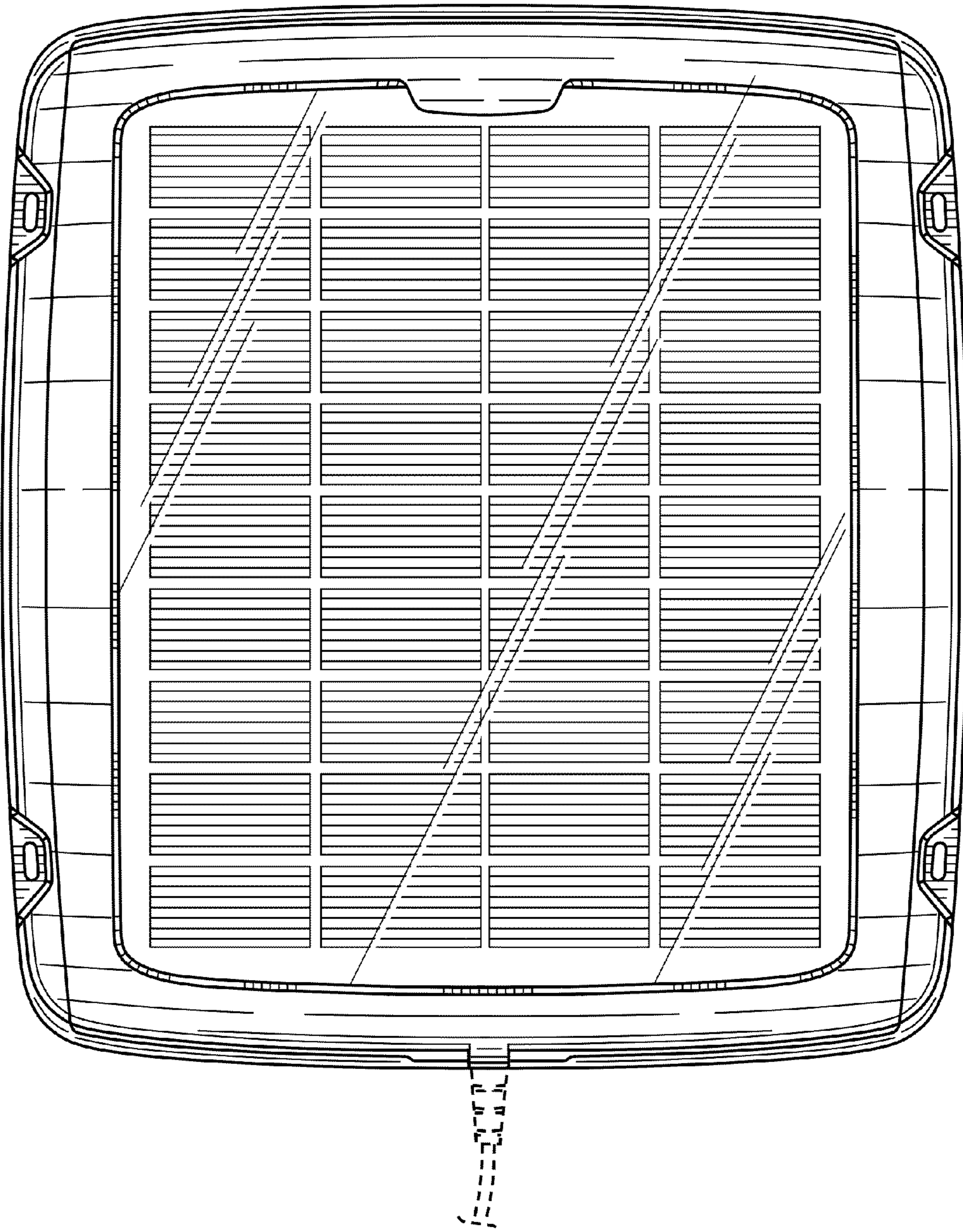

FIG. 2

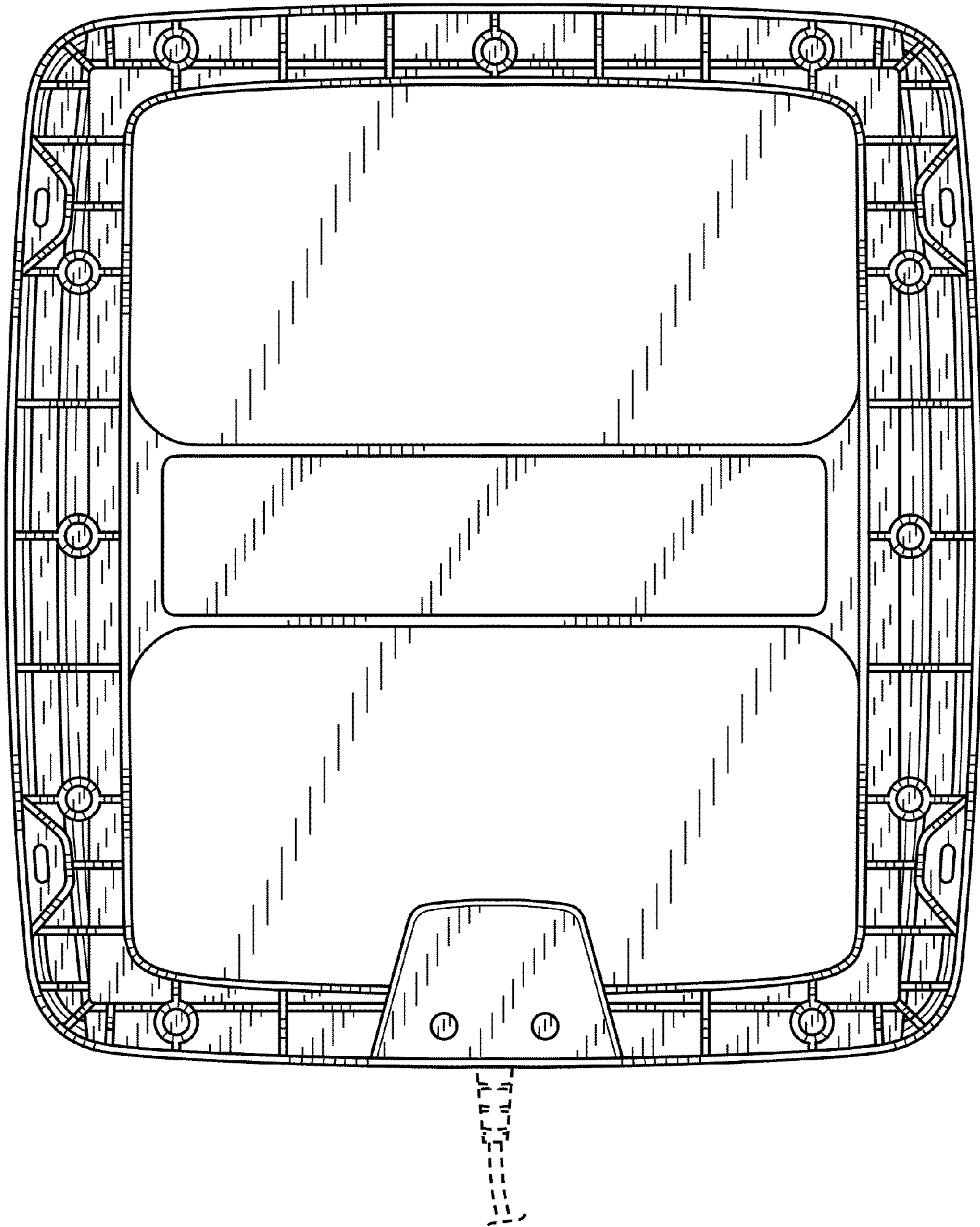

FIG. 3

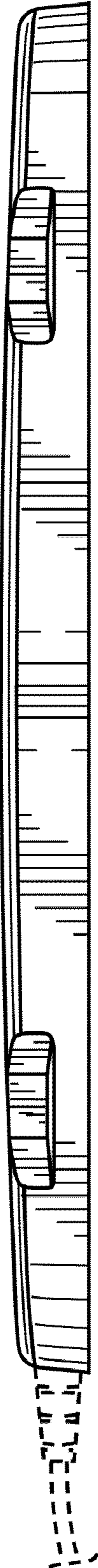

FIG. 4

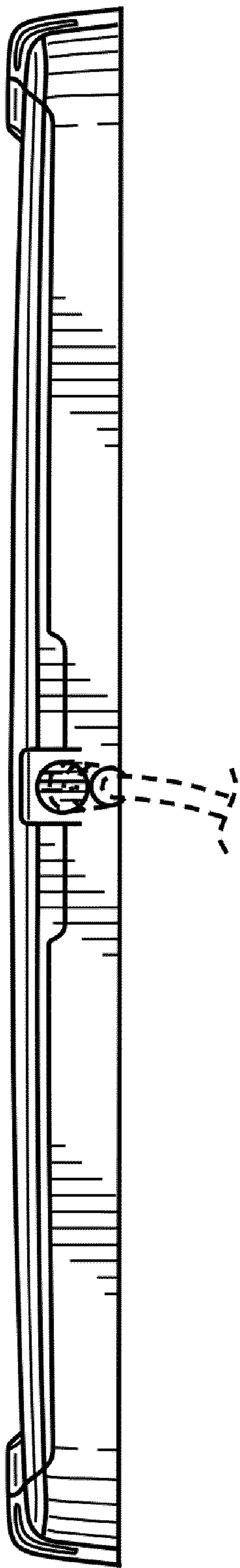

FIG. 5

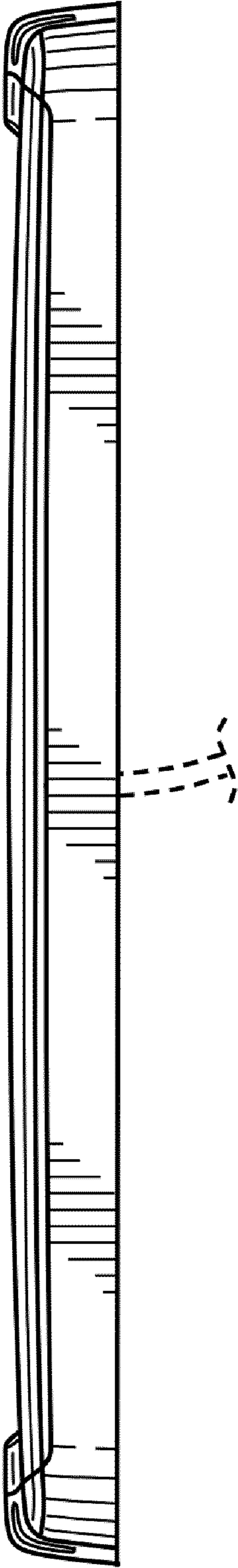

FIG. 6