



US00D679151S

(12) **United States Design Patent**
Pezzini

(10) **Patent No.:** **US D679,151 S**

(45) **Date of Patent:** **** Apr. 2, 2013**

(54) **BONING KNIFE**

(75) Inventor: **Gabriele Pezzini**, Quarry Bay (HK)

(73) Assignee: **Compagnie des Arts de la Table**, Paris (FR)

(**) Term: **14 Years**

(21) Appl. No.: **29/409,452**

(22) Filed: **Dec. 22, 2011**

(30) **Foreign Application Priority Data**

Aug. 9, 2011 (WO) DM/076 956

(51) **LOC (9) Cl.** **07-03**

(52) **U.S. Cl.** **D7/649**

(58) **Field of Classification Search** D7/368,
D7/393-395, 401.2, 642-646, 649-654, 660-664,
D7/669, 675-676, 683, 688-692, 695-696;
D8/25, 83, 99, 102, 107, 303; D22/118;
30/125, 137, 141-143, 147-150, 322-327,
30/329, 340, 342-344; 416/70 R

See application file for complete search history.

(56) **References Cited**

U.S. PATENT DOCUMENTS

D220,930 S * 6/1971 Arlett D22/118
D247,970 S * 5/1978 Nordlund D22/118

D256,548 S * 8/1980 Grunstad D8/102
D271,124 S * 10/1983 Ferraro D22/118
D333,239 S * 2/1993 Pogue D7/649
D359,789 S * 6/1995 Seber et al. D22/118
D366,515 S * 1/1996 Thompson D22/118
5,528,834 A * 6/1996 Seber et al. 30/340
D392,870 S * 3/1998 Balolia D8/107
D439,495 S * 3/2001 McCalla et al. D8/107
D446,571 S * 8/2001 Frazer D22/118
D559,045 S * 1/2008 Ono D7/649

* cited by examiner

Primary Examiner — Ricky Pham

(74) *Attorney, Agent, or Firm* — Foley & Lardner LLP

(57) **CLAIM**

I claim the ornamental design for a boning knife, as shown and described.

DESCRIPTION

FIG. 1 is a front view of a boning knife of the claimed design; FIG. 2 is a rear view of the boning knife shown in FIG. 1; FIG. 3 is a right side view of the boning knife shown in FIG. 1; FIG. 4 is a left side view of the boning knife shown in FIG. 1; FIG. 5 is a top view of the boning knife shown in FIG. 1; FIG. 6 is a bottom view of the boning knife shown in FIG. 1; and, FIG. 7 is a front perspective view of the boning knife shown in FIG. 1.

The ornamental design which is claimed is shown in the drawings.

1 Claim, 4 Drawing Sheets

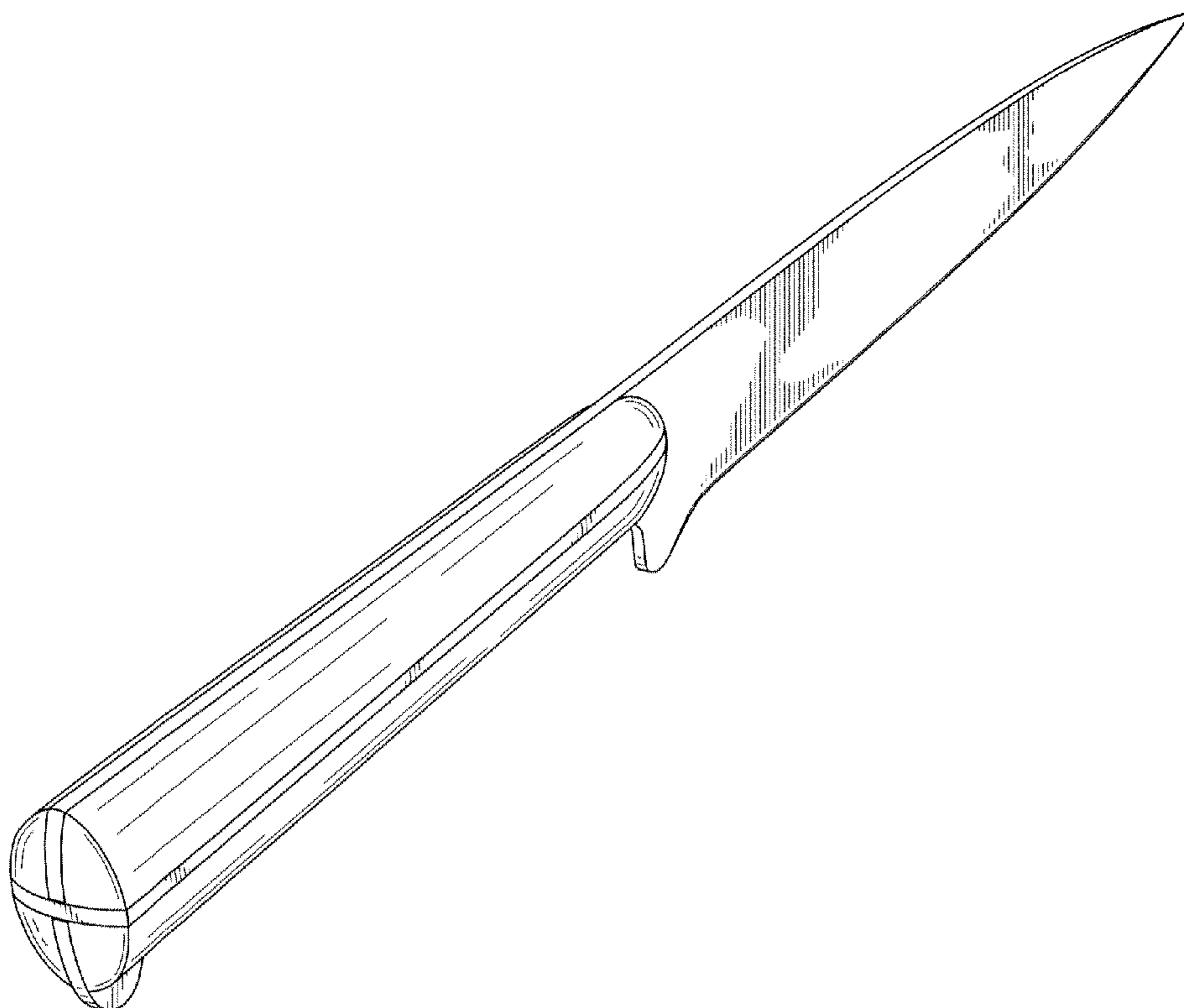

Fig. 1

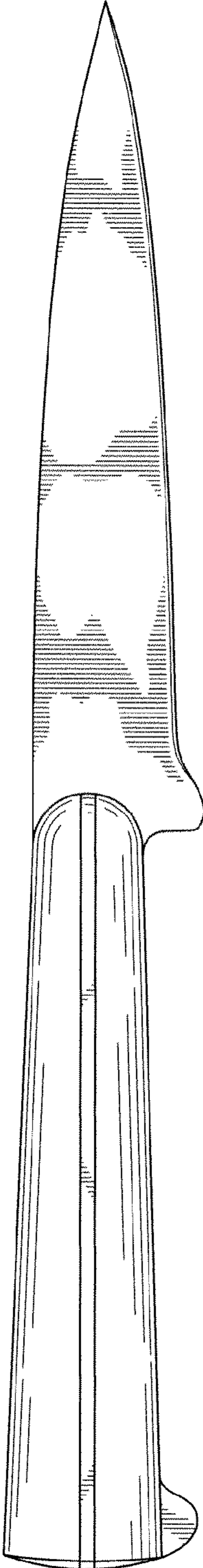

Fig. 2

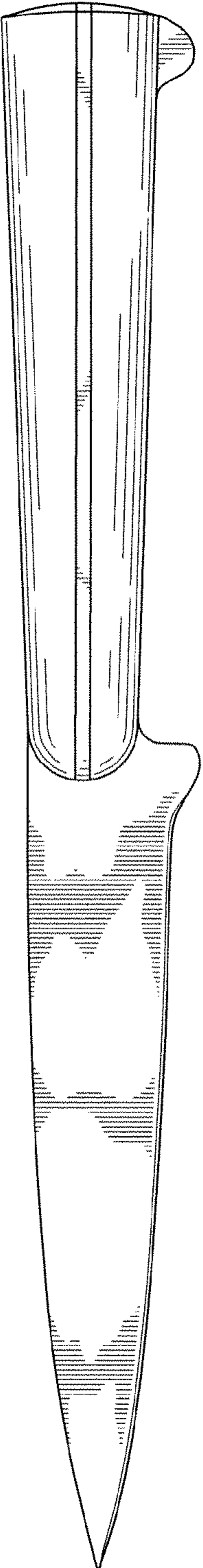

Fig. 4

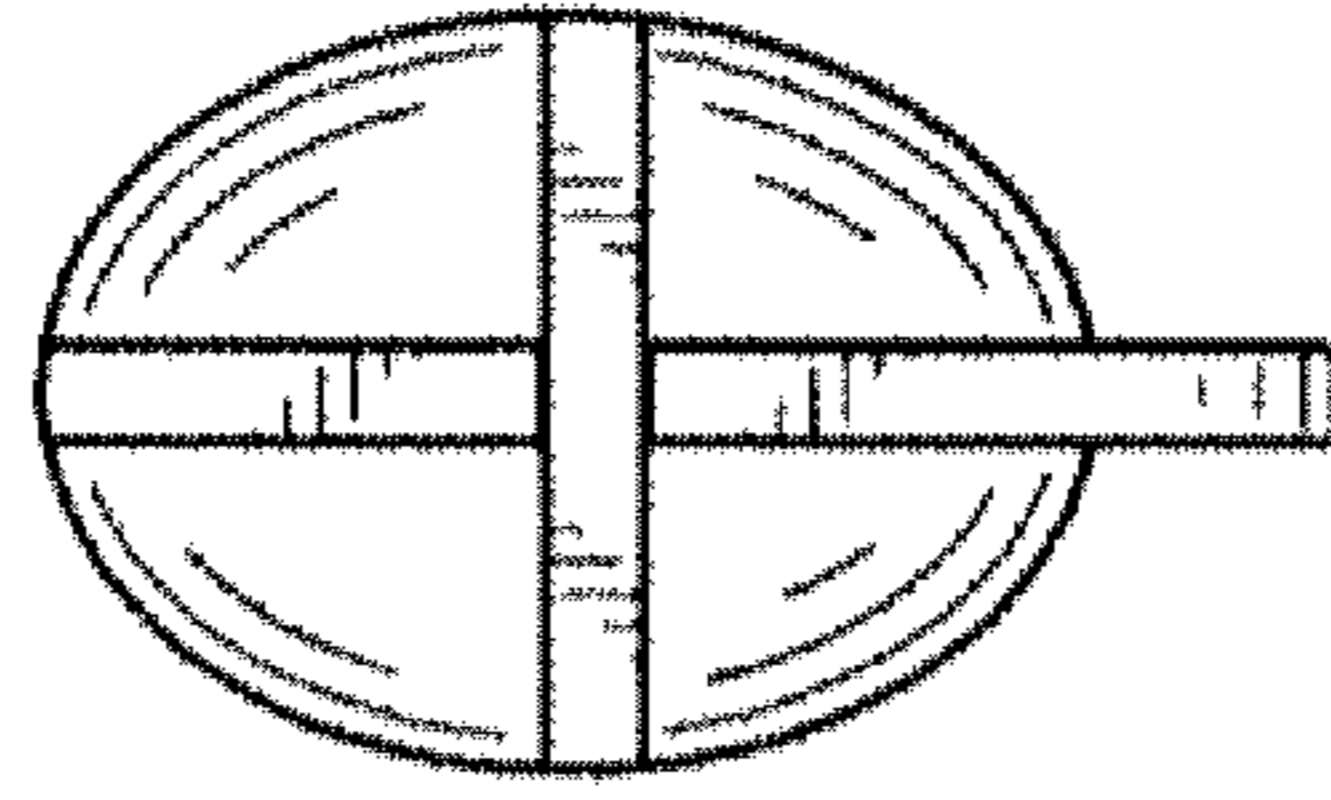

Fig. 3

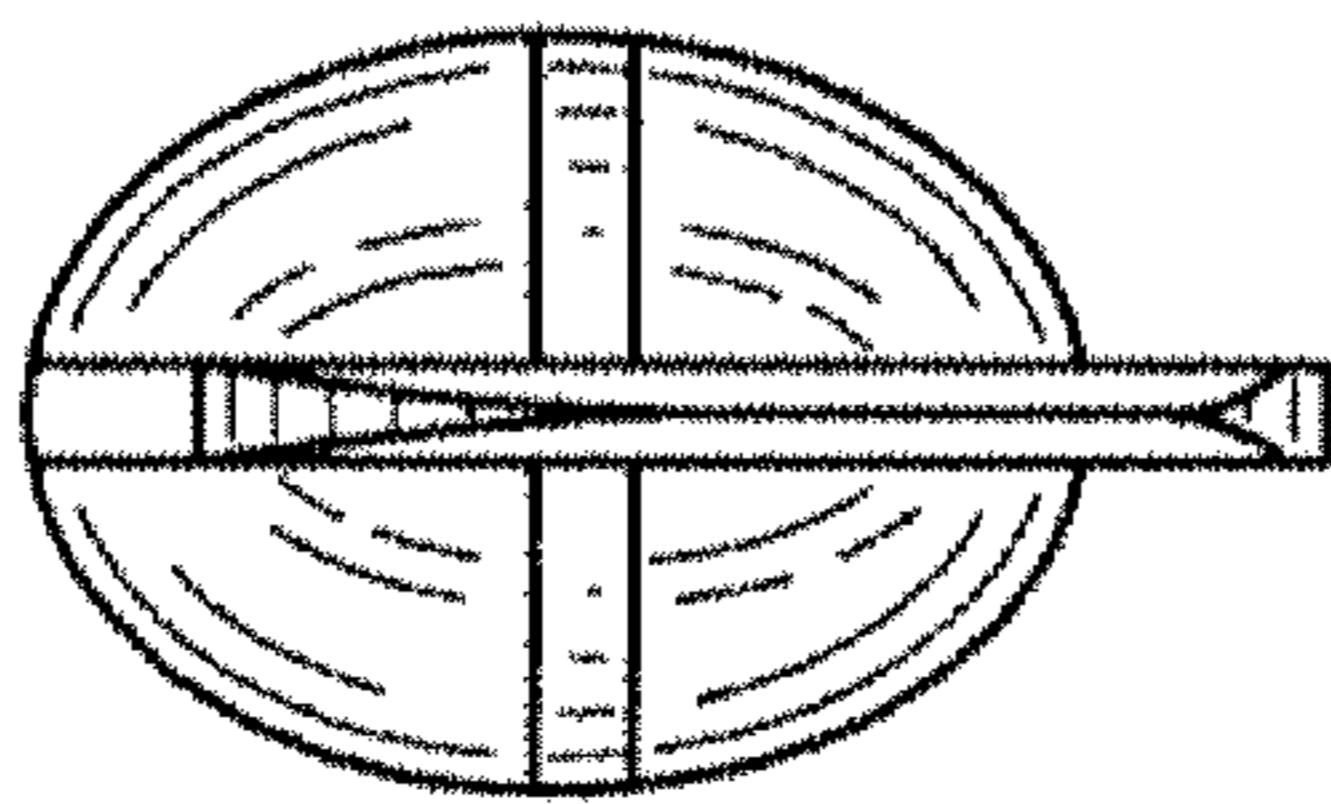

Fig. 5

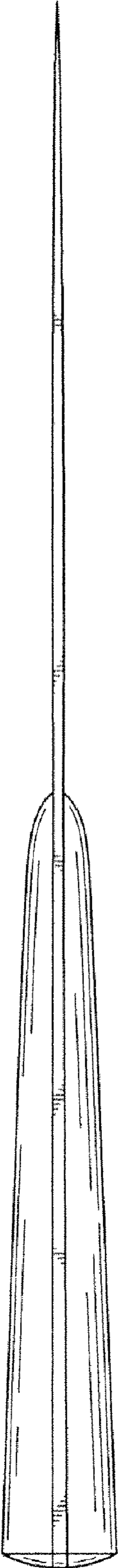

Fig. 6

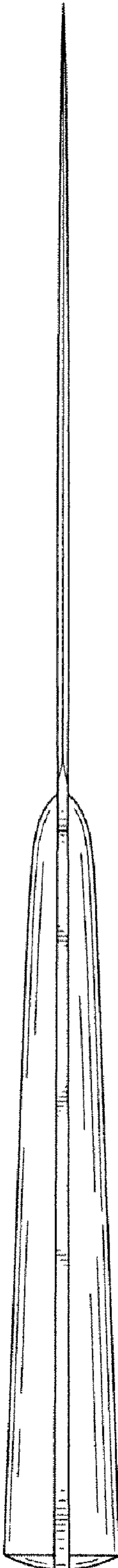

Fig. 7

