



US00D679122S

(12) **United States Design Patent**  
**Rojas**

(10) **Patent No.:** **US D679,122 S**

(45) **Date of Patent:** **\*\* Apr. 2, 2013**

(54) **OCTOPUS SHOWER CADDY**

(75) Inventor: **Jarad Rojas**, Fairview, NJ (US)

(73) Assignee: **Crosskill Home LLC**, New York, NY (US)

(\*\*) Term: **14 Years**

(21) Appl. No.: **29/413,407**

(22) Filed: **Feb. 15, 2012**

(51) **LOC (9) Cl.** ..... **23-02**

(52) **U.S. Cl.** ..... **D6/525; D6/528**

(58) **Field of Classification Search** ..... D21/601;  
150/100, 107, 110, 127-128; 224/158, 575;  
220/761, 763, 773, 776; D6/524, 525, 528;  
211/13.1, 69.5, 71.01; 248/302, 309.1, 314  
See application file for complete search history.

(56) **References Cited**

**U.S. PATENT DOCUMENTS**

D258,902 S *	4/1981	Strickland	.....	D21/601
D554,714 S *	11/2007	Chow	.....	D21/601
D609,514 S *	2/2010	Hayen	.....	D6/525
D634,372 S *	3/2011	Garofalo	.....	D21/601

\* cited by examiner

*Primary Examiner* — Brian N Vinson

(74) *Attorney, Agent, or Firm* — Buchanan Ingersoll & Rooney PC

(57) **CLAIM**

The ornamental design for an octopus shower caddy, as shown and described.

**DESCRIPTION**

FIG. 1 is a front perspective view of an octopus shower caddy of the invention;

FIG. 2 is a front perspective view of an octopus shower caddy, with a detachable suction cup shown as separated from the caddy;

FIG. 3 is a rear perspective view of an octopus shower caddy, with a detachable suction cup shown as separated from the caddy;

FIG. 4 is a front view thereof;

FIG. 5 is a rear view thereof;

FIG. 6 is a top view thereof;

FIG. 7 is a bottom view thereof;

FIG. 8 is a right side view thereof;

FIG. 9 is a left side view thereof; and,

FIG. 10 is an additional perspective view thereof, with the broken-line disclosure of a toothbrush being for illustrative purposes only and forming no part of the claimed design.

**1 Claim, 6 Drawing Sheets**

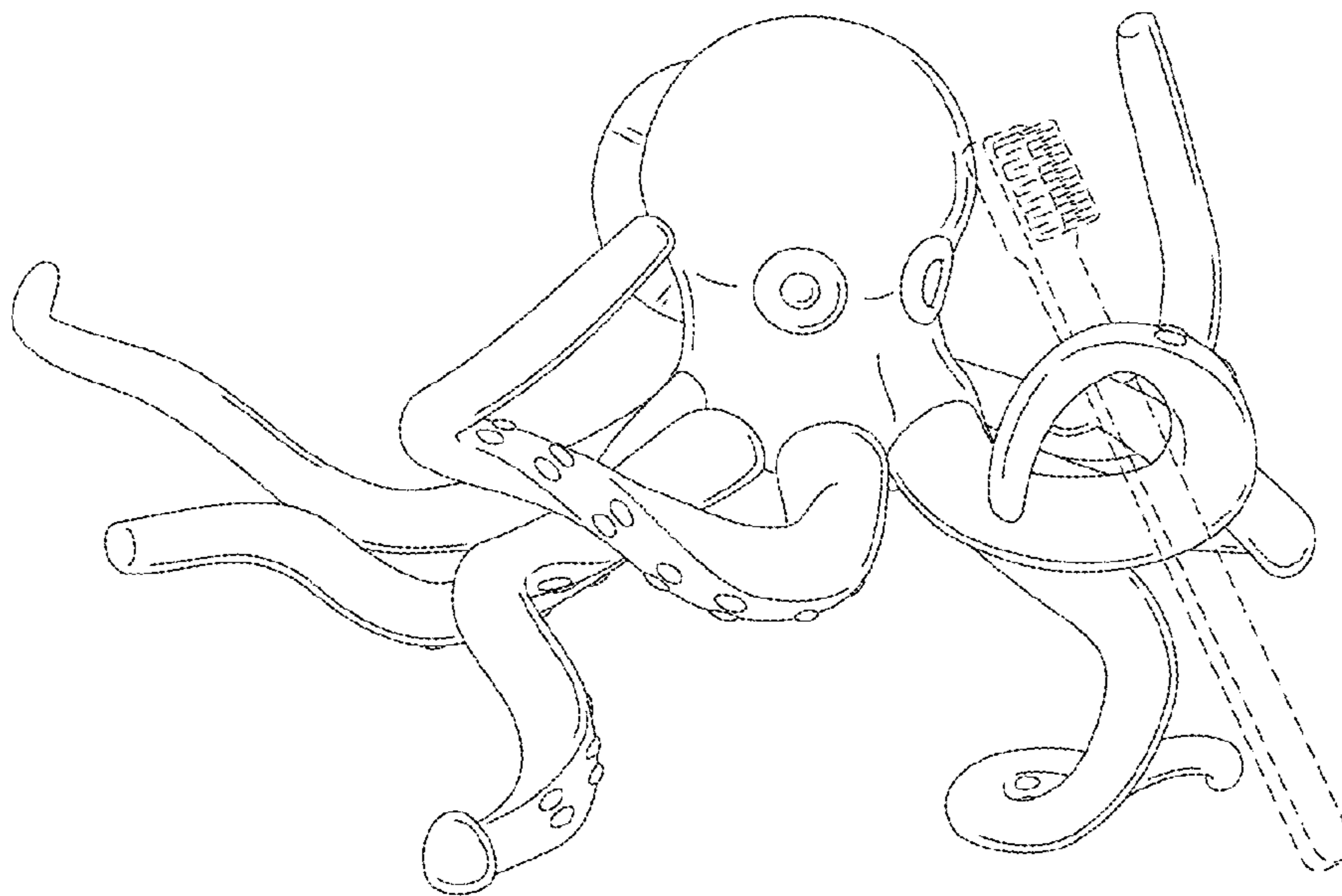

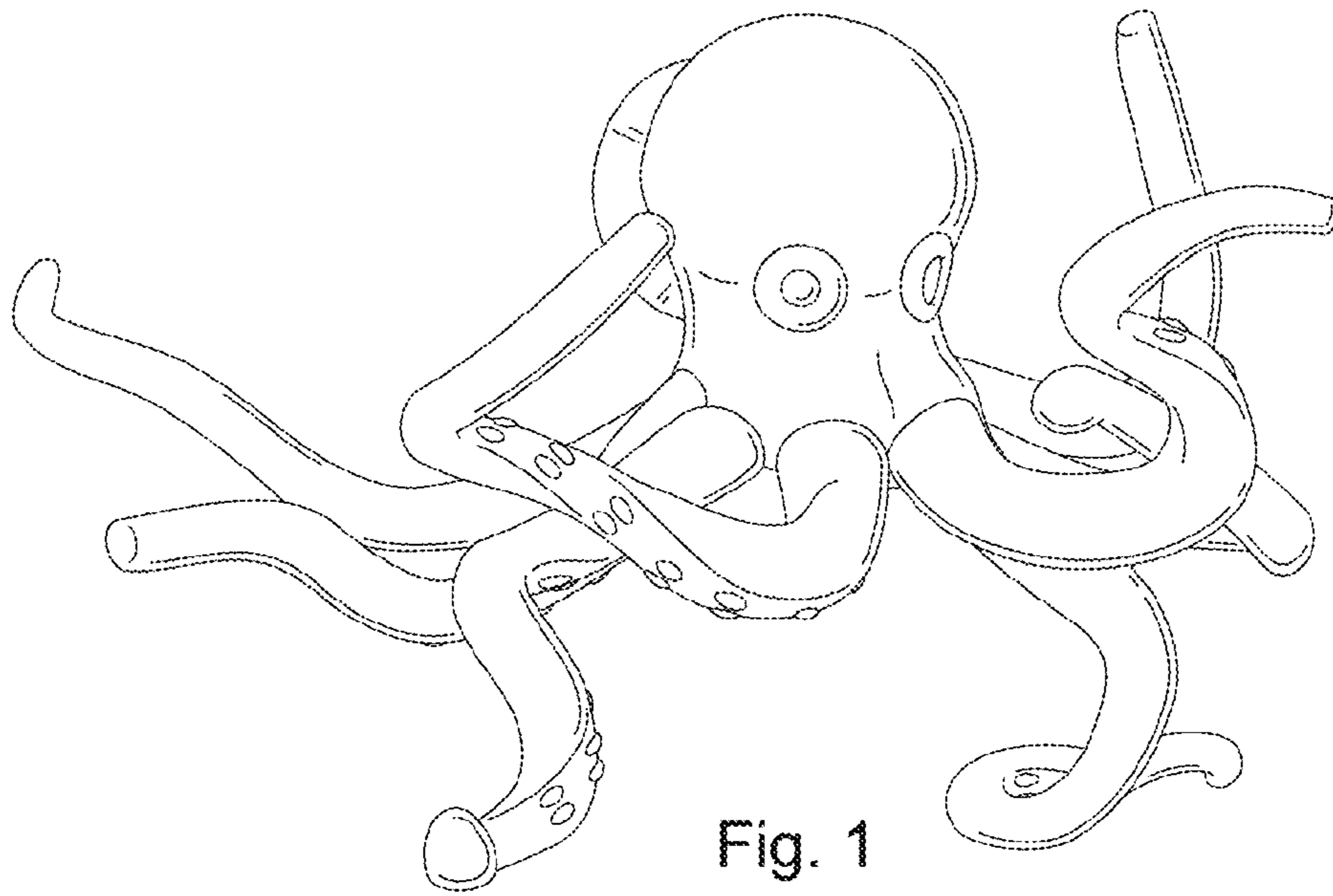

Fig. 1

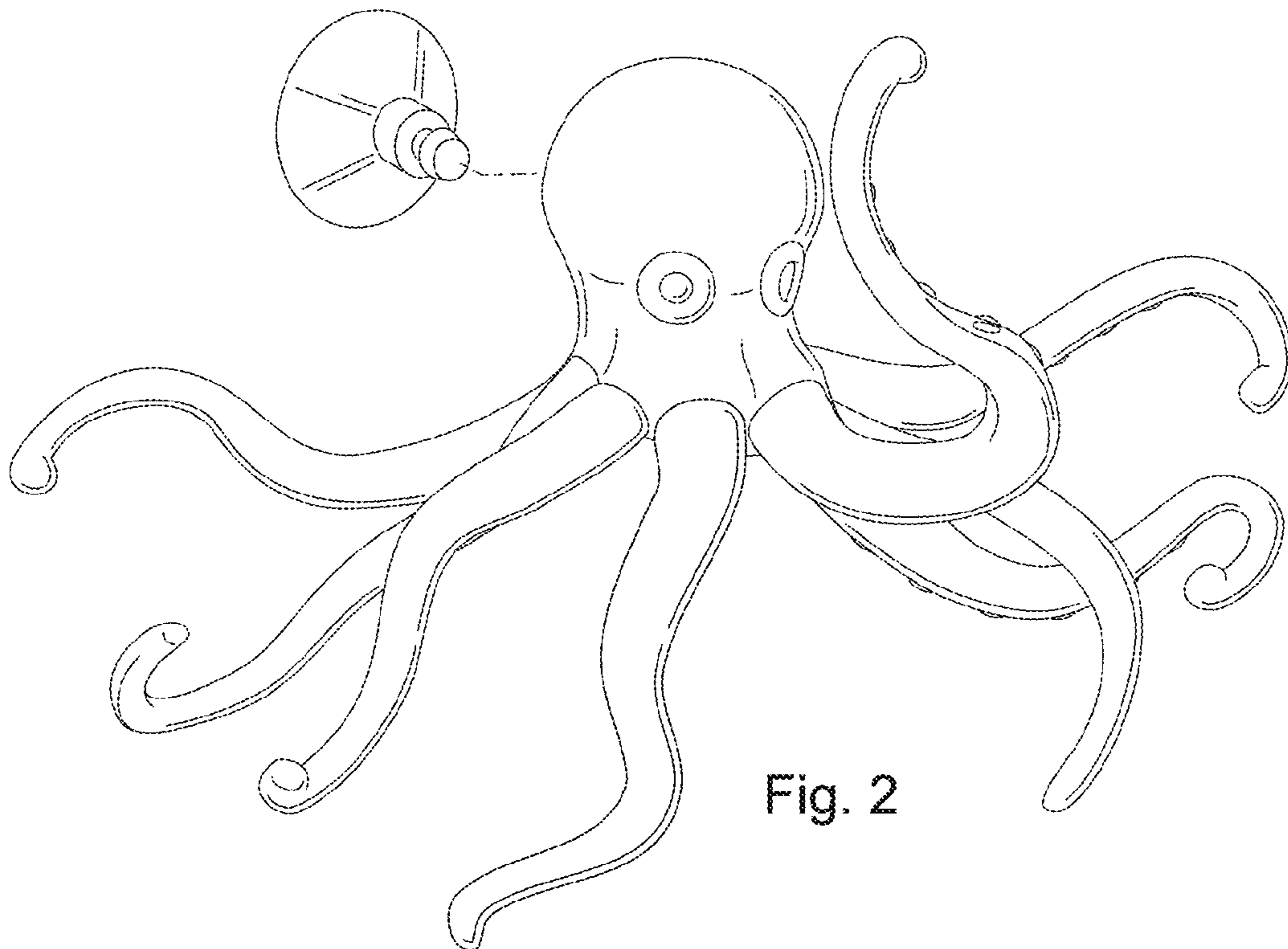

Fig. 2

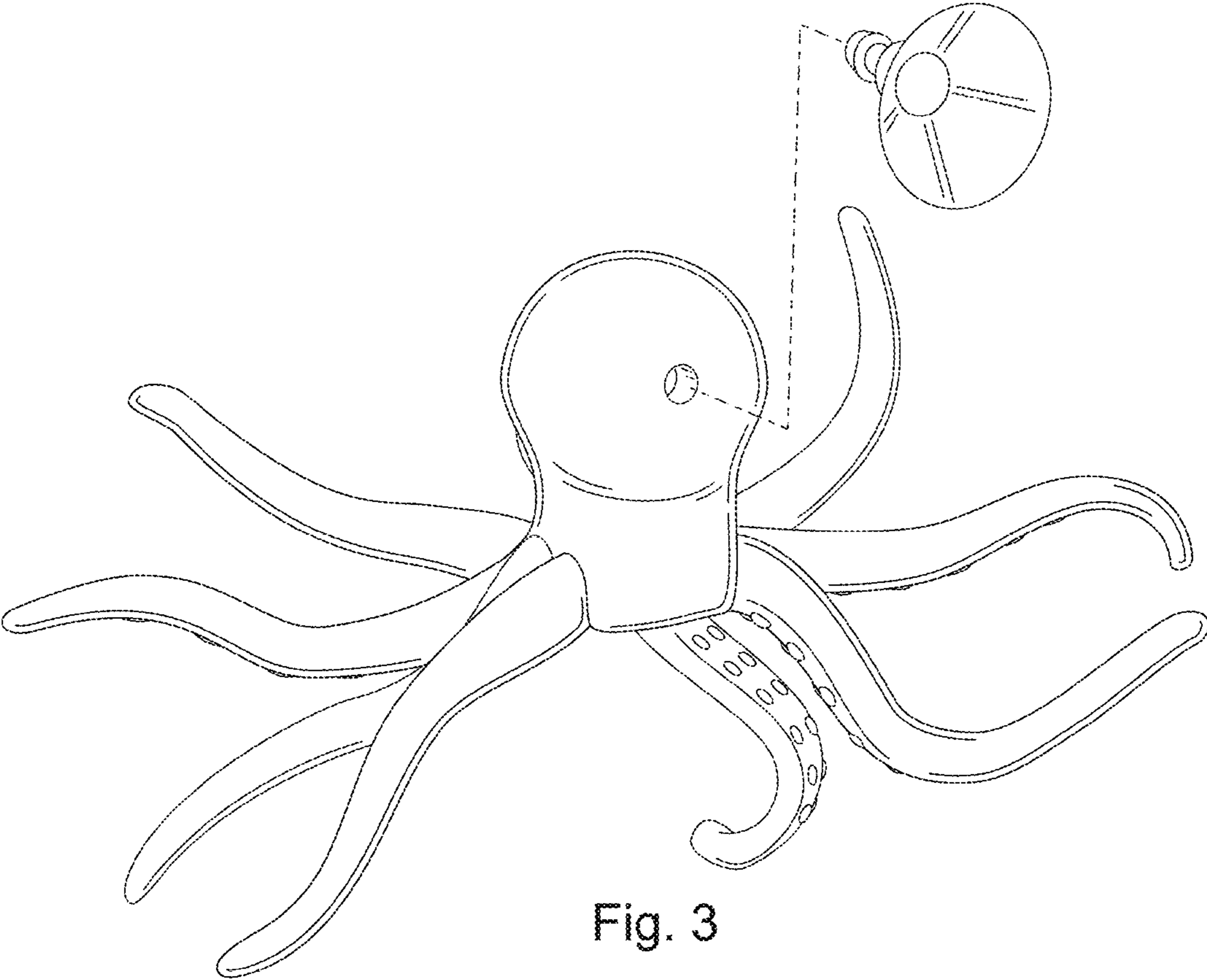

Fig. 3

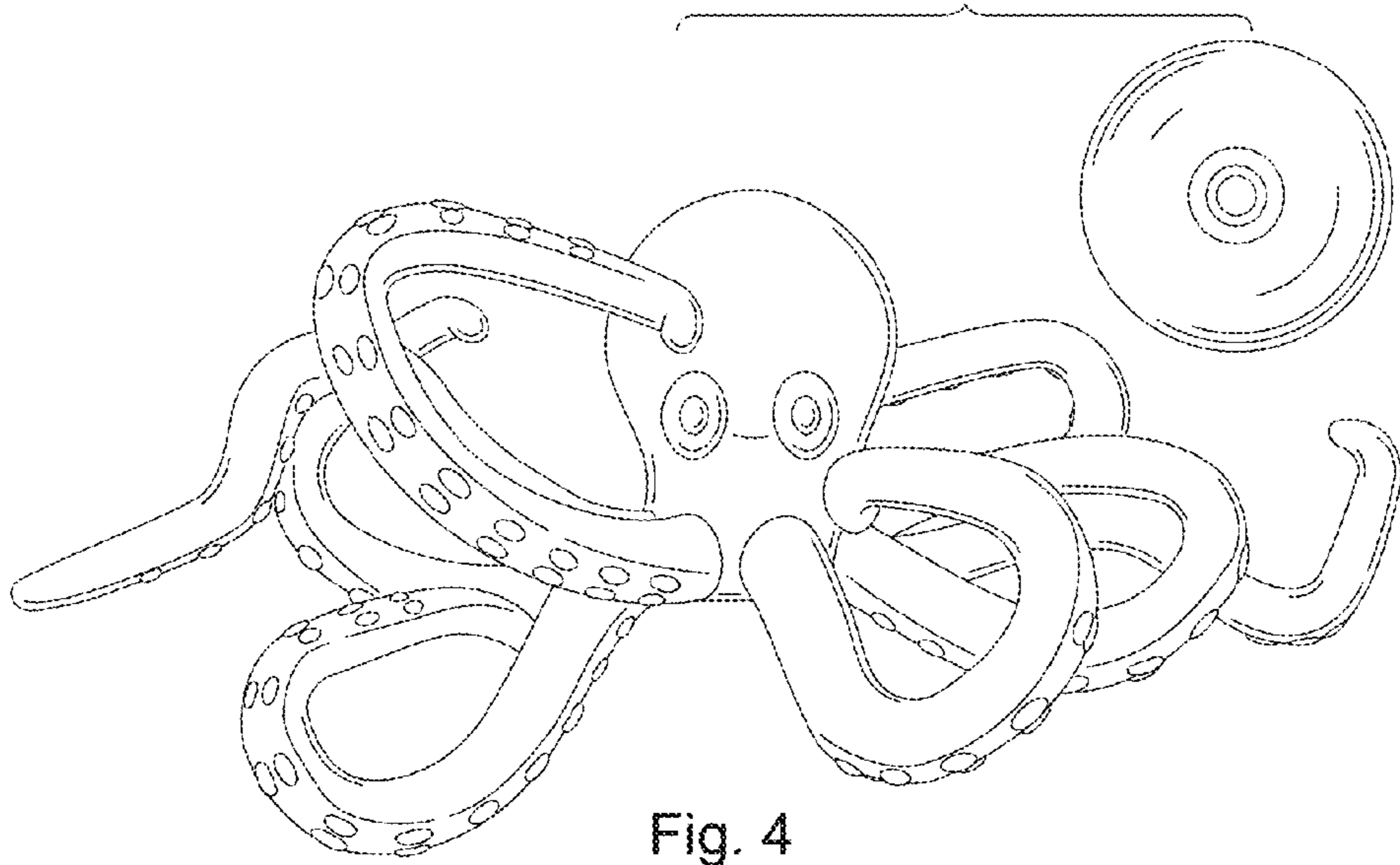

Fig. 4

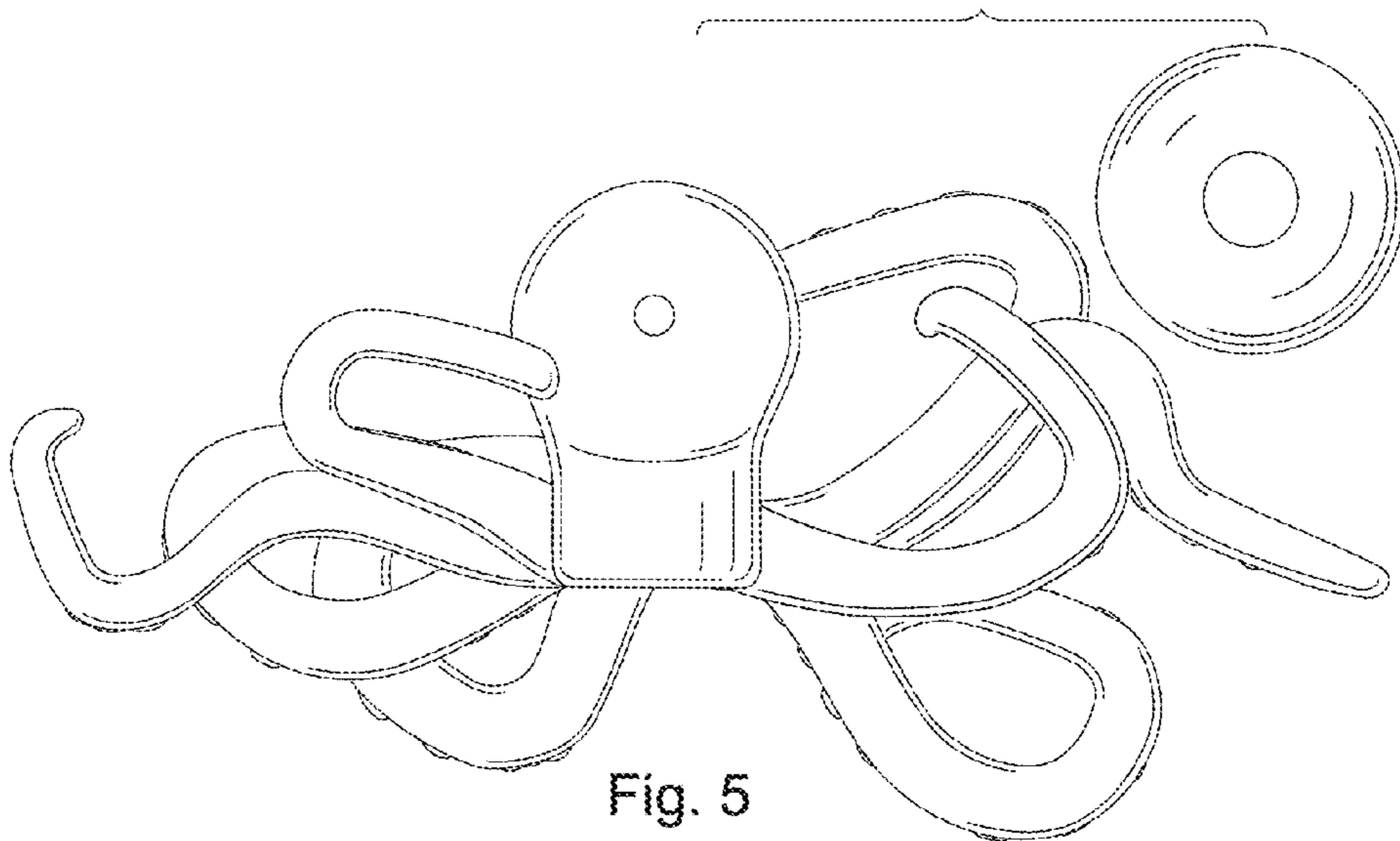

Fig. 5

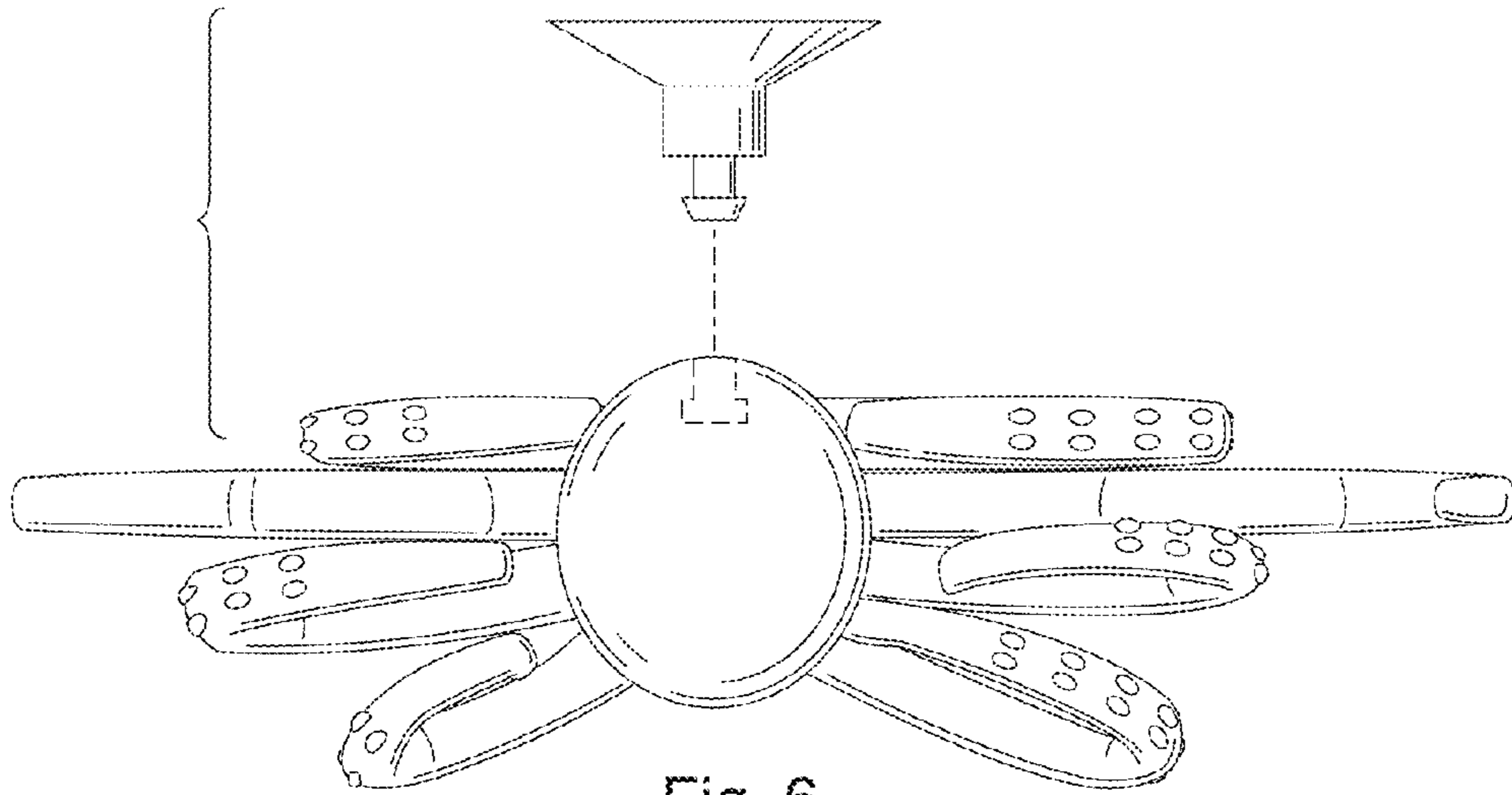

Fig. 6

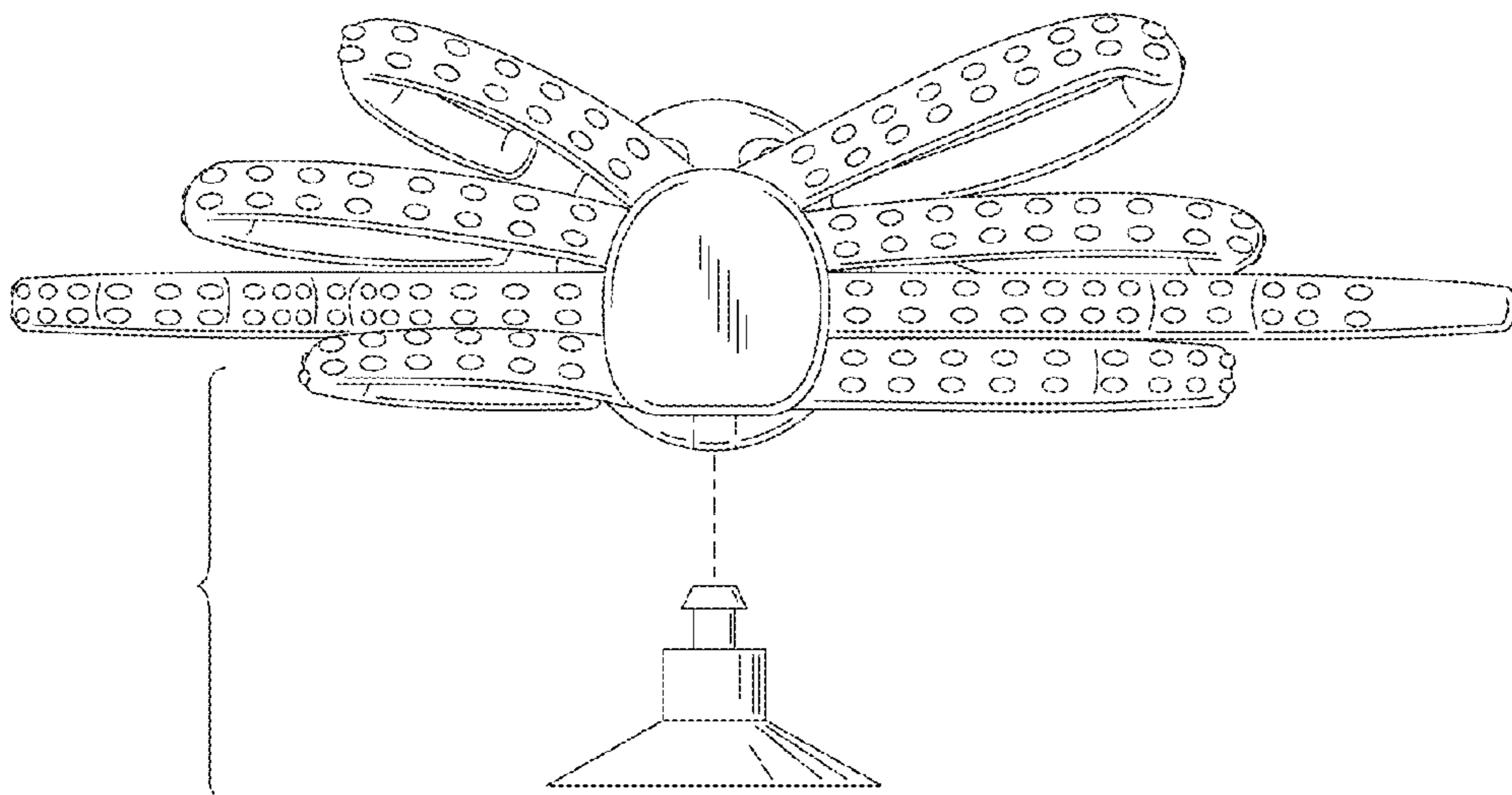
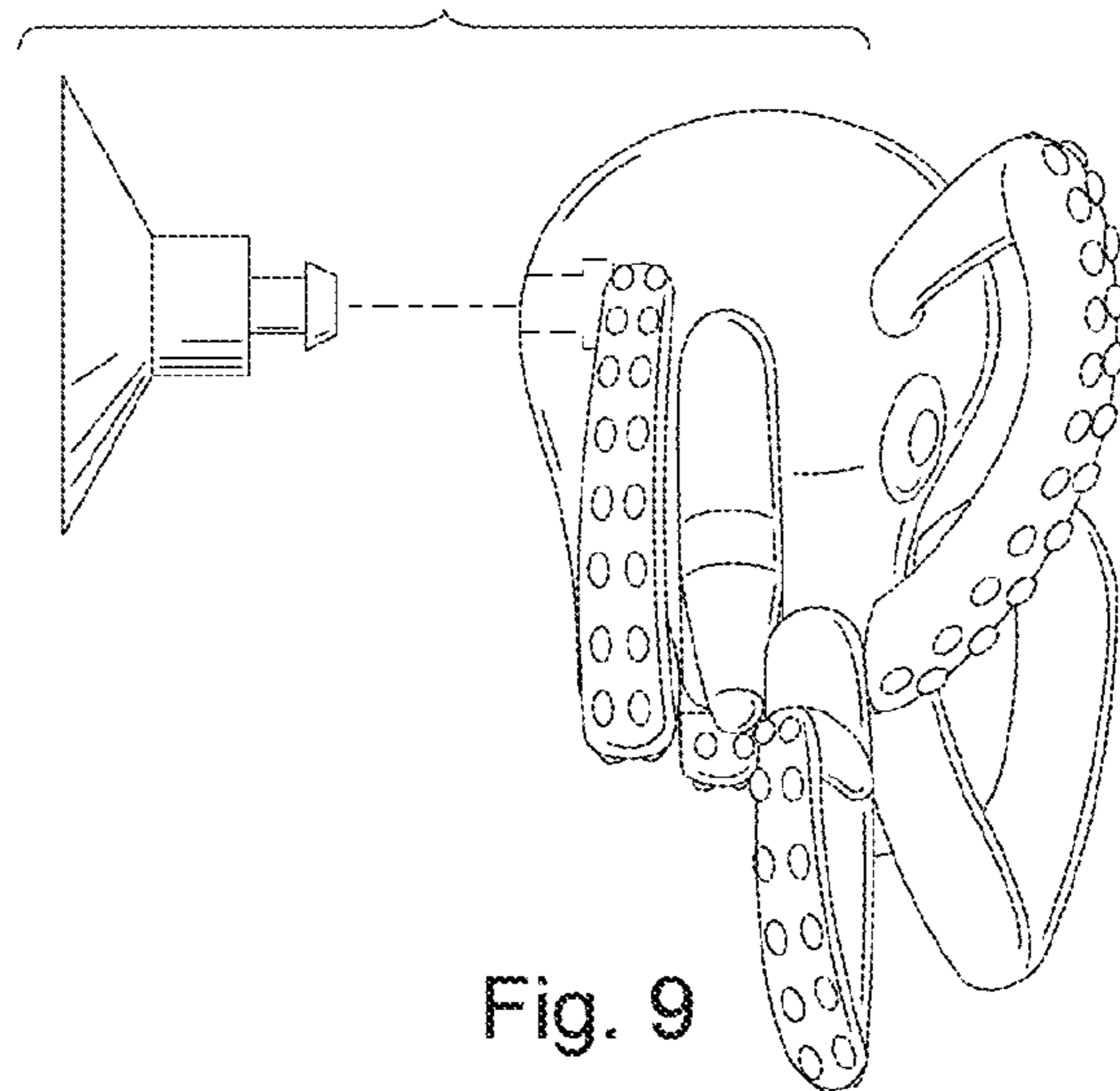
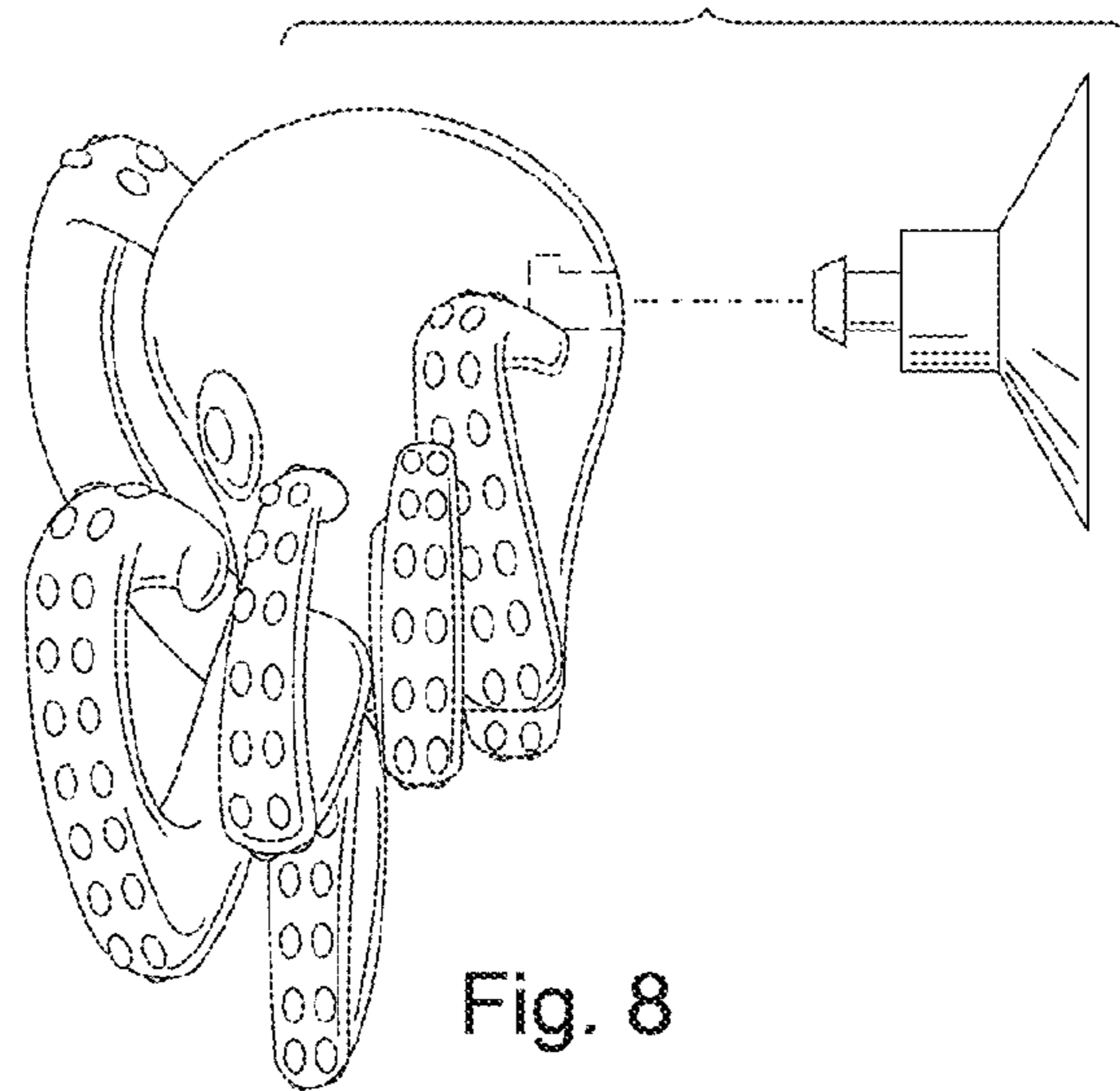

Fig. 7



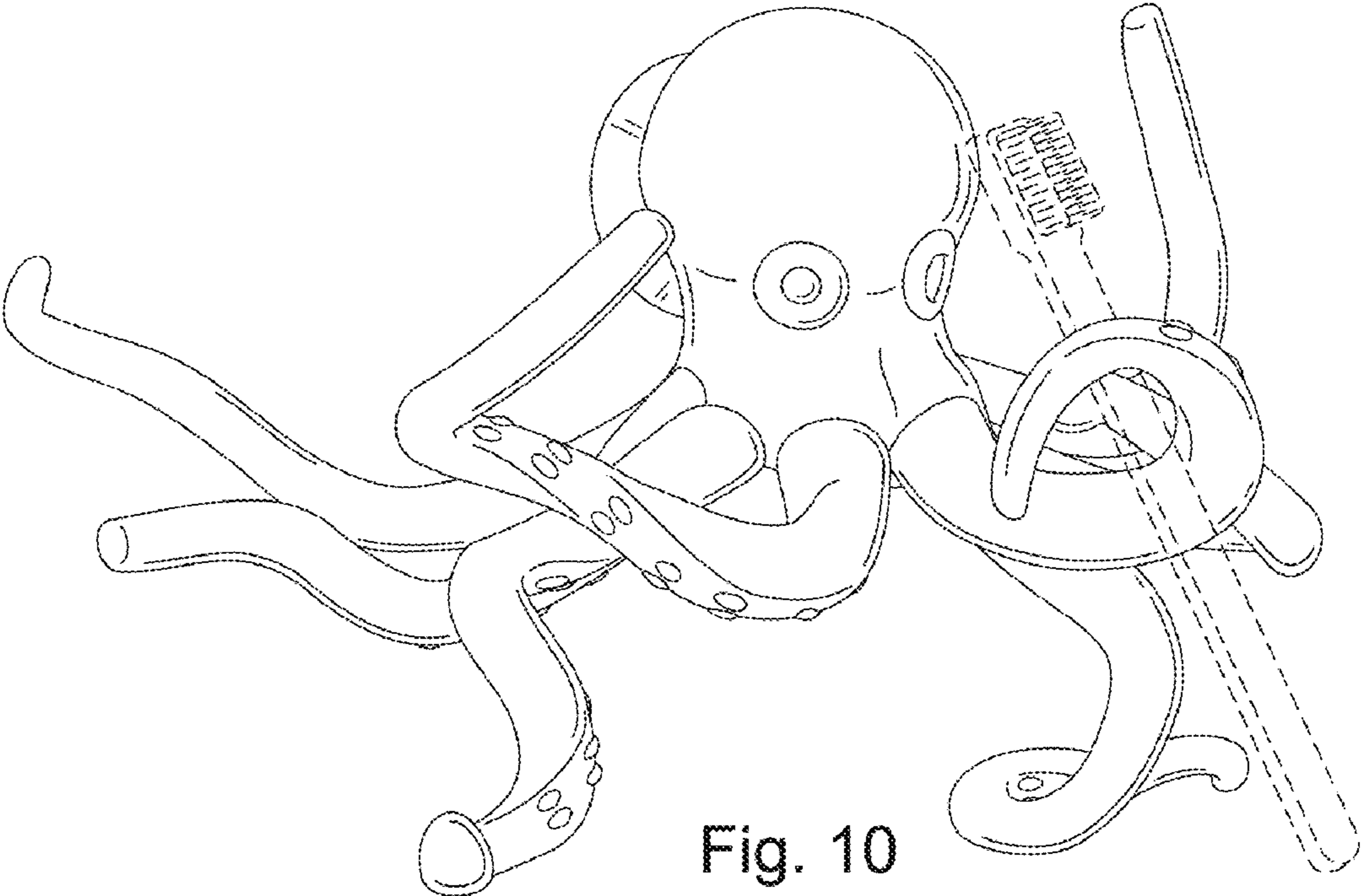

Fig. 10