



US00D679116S

(12) **United States Design Patent**
Evangelidis

(10) **Patent No.:** **US D679,116 S**
(45) **Date of Patent:** **** Apr. 2, 2013**

- (54) **MODULAR STORAGE UNIT SET**
 - (75) Inventor: **Andrew Evangelidis**, Pierrefonds (CA)
 - (73) Assignee: **Alexia Holdings Inc.**, Quebec (CA)
 - (**) Term: **14 Years**
 - (21) Appl. No.: **29/367,447**
 - (22) Filed: **Aug. 9, 2010**
 - (30) **Foreign Application Priority Data**
 - Jul. 6, 2010 (CA) 136217
 - (51) **LOC (9) Cl.** **06-06**
 - (52) **U.S. Cl.** **D6/445**
 - (58) **Field of Classification Search** D3/260,
D3/272-276, 283, 294-297, 318, 321-322,
D3/903, 905; D6/396-397, 432-448, 422-430,
D6/477-479, 491; 5/2.1; 312/139.1, 198-200,
312/204, 249.11, 249.12, 257.1, 280-28,
312/308, 2
- See application file for complete search history.

- (56) **References Cited**
- U.S. PATENT DOCUMENTS
- D249,427 S * 9/1978 Neveux D6/436
(Continued)
- FOREIGN PATENT DOCUMENTS
- CA 60767 5/1988
(Continued)

Primary Examiner — Kelley Donnelly
(74) *Attorney, Agent, or Firm* — Gottlieb, Rackman & Reisman, PC

(57) **CLAIM**
I claim the ornamental design for a modular storage unit set, as shown and described.

DESCRIPTION

FIG. 1 is a perspective view of the modular storage unit set; FIG. 2 is of a perspective view of the overhead reach-in module of the modular storage unit set of FIG. 1;

FIG. 3 is a top view of FIG. 2;
 FIG. 4 is a left side view of FIG. 2;
 FIG. 5 is a front view of FIG. 2;
 FIG. 6 is a right side view of FIG. 2;
 FIG. 7 is a perspective view of the first upright cabinet module of the modular storage unit set of FIG. 1;
 FIG. 8 is a top view of FIG. 7;
 FIG. 9 is a left side view of FIG. 7;
 FIG. 10 is a front view of FIG. 7;
 FIG. 11 is a right side view of FIG. 7;
 FIG. 12 is a perspective view of the second upright cabinet module of the modular storage unit set of FIG. 1;
 FIG. 13 is a top view of FIG. 12;
 FIG. 14 is a left side view of FIG. 12;
 FIG. 15 is a front view of FIG. 12;
 FIG. 16 is a right side view of FIG. 12;
 FIG. 17 is a perspective view of the upright drawer module of the modular storage unit set of FIG. 1;
 FIG. 18 is a top view of FIG. 17;
 FIG. 19 is a left side view of FIG. 17;
 FIG. 20 is a front view of FIG. 17;
 FIG. 21 is a right side view of FIG. 17;
 FIG. 22 is a perspective view of the first full upright cabinet module of the modular storage unit set of FIG. 1;
 FIG. 23 is a top view of FIG. 22;
 FIG. 24 is a left side view of FIG. 22;
 FIG. 25 is a front view of FIG. 22;
 FIG. 26 is a right side view of FIG. 22;
 FIG. 27 is a perspective view of the second full upright cabinet module of the modular storage unit set of FIG. 1;
 FIG. 28 is a top view of FIG. 27;
 FIG. 29 is a left side view of FIG. 27;
 FIG. 30 is a front view of FIG. 27;
 FIG. 31 is a right side view of FIG. 27;
 FIG. 32 is a perspective view of the overhead venthood module of the modular storage unit set of FIG. 1;
 FIG. 33 is a top view of FIG. 32;
 FIG. 34 is a left side view of FIG. 32;
 FIG. 35 is a front view of FIG. 32; and,
 FIG. 36 is a right side view of FIG. 32.

The broken lines showing the environment in some of the figures are for illustrative purpose only and form no part of the claimed design.

1 Claim, 8 Drawing Sheets

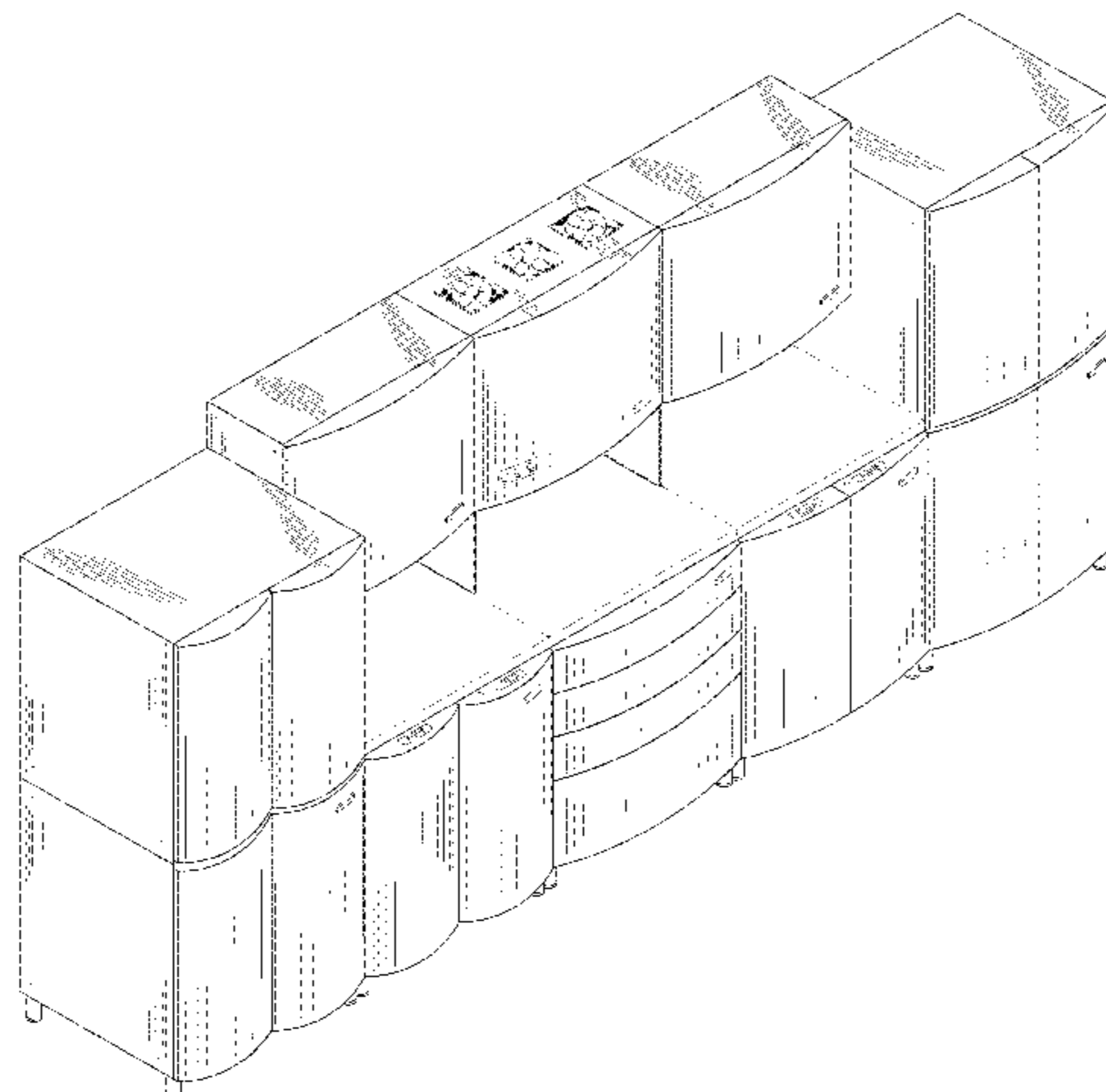

US D679,116 S

Page 2

U.S. PATENT DOCUMENTS

D287,079	S	*	12/1986	Mintjens	D6/436	CA	90615	10/2000
D336,392	S	*	6/1993	Whalen	D6/446	CA	99198	2/2004
D375,211	S	*	11/1996	Mizzi	D6/397	CA	120117	11/2008
D433,841	S	*	11/2000	Huber et al.	D6/436	CA	120118	11/2008
D445,594	S	*	7/2001	McClintock et al.	D6/397	CA	120134	11/2008
D458,048	S	*	6/2002	Camfferman et al.	D6/436	CA	120135	11/2008
D481,884	S	*	11/2003	Richardson et al.	D6/396	CA	120136	11/2008
D488,001	S	*	4/2004	Richardson et al.	D6/436	CA	120137	11/2008
D497,269	S	*	10/2004	Richardson et al.	D6/436	CA	120138	11/2008
D528,835	S	*	9/2006	Lee et al.	D6/509	CA	120139	11/2008
D557,041	S	*	12/2007	Lee et al.	D6/468	CA	120140	11/2008
7,360,915	B2	*	4/2008	Richardson et al.	362/125	CA	120141	11/2008
D571,477	S	*	6/2008	Terrill	D24/217	CA	120142	11/2008
7,604,132	B2	*	10/2009	Richardson et al.	211/189	CA	120143	11/2008
D604,529	S	*	11/2009	Bloch et al.	D6/422	CA	120144	11/2008
D608,109	S	*	1/2010	Hand	D6/445	CA	120145	11/2008
7,954,653	B2	*	6/2011	Adams et al.	211/85.16	CA	120513	11/2008
D641,992	S	*	7/2011	Giroux et al.	D6/396	CA	120663	11/2008
D644,038	S	*	8/2011	Denk et al.	D6/439	CA	120668	11/2008
D653,051	S	*	1/2012	Lin	D6/436	CA	120691	11/2008
2005/0102918	A1	*	5/2005	Richardson et al.	52/79.1	CA	108394	6/2009

FOREIGN PATENT DOCUMENTS

CA	64709	11/1989							
CA	74437	7/1994					CA	115725	6/2009
CA	74514	8/1994					CA	116058	6/2009
CA	80964	6/1997					CA	116067	6/2009
							CA	116078	6/2009

* cited by examiner

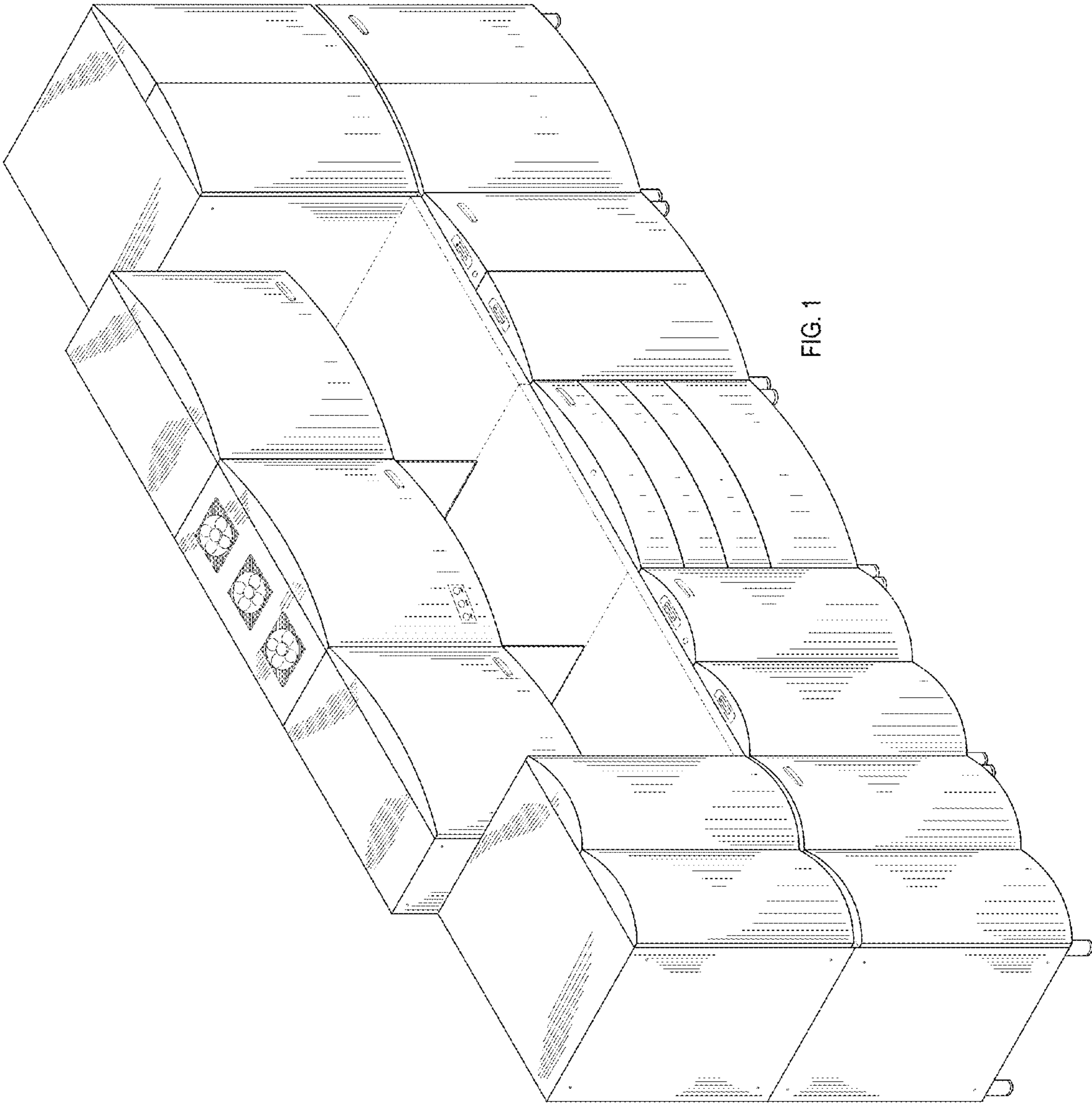

FIG. 1

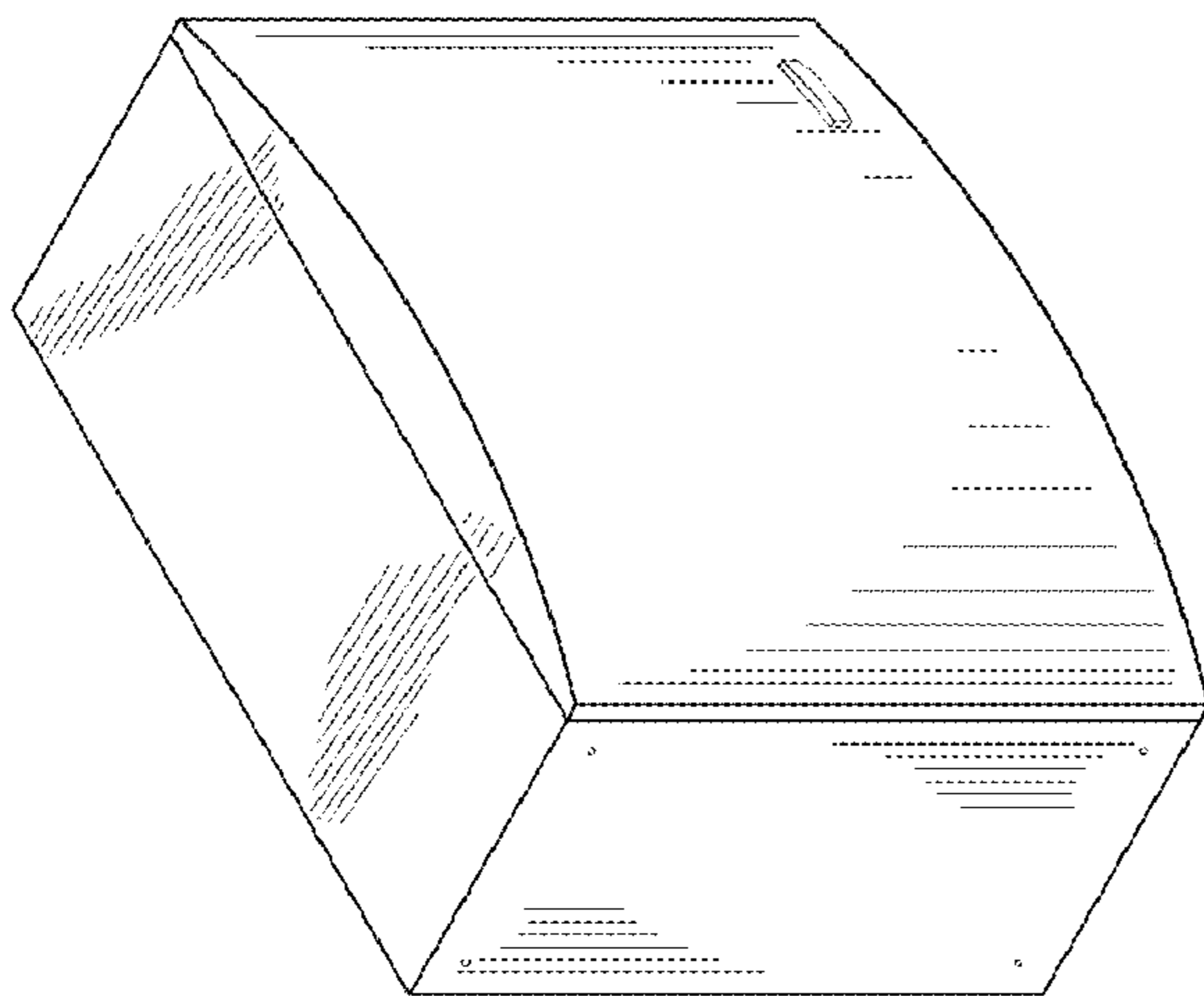

FIG. 2

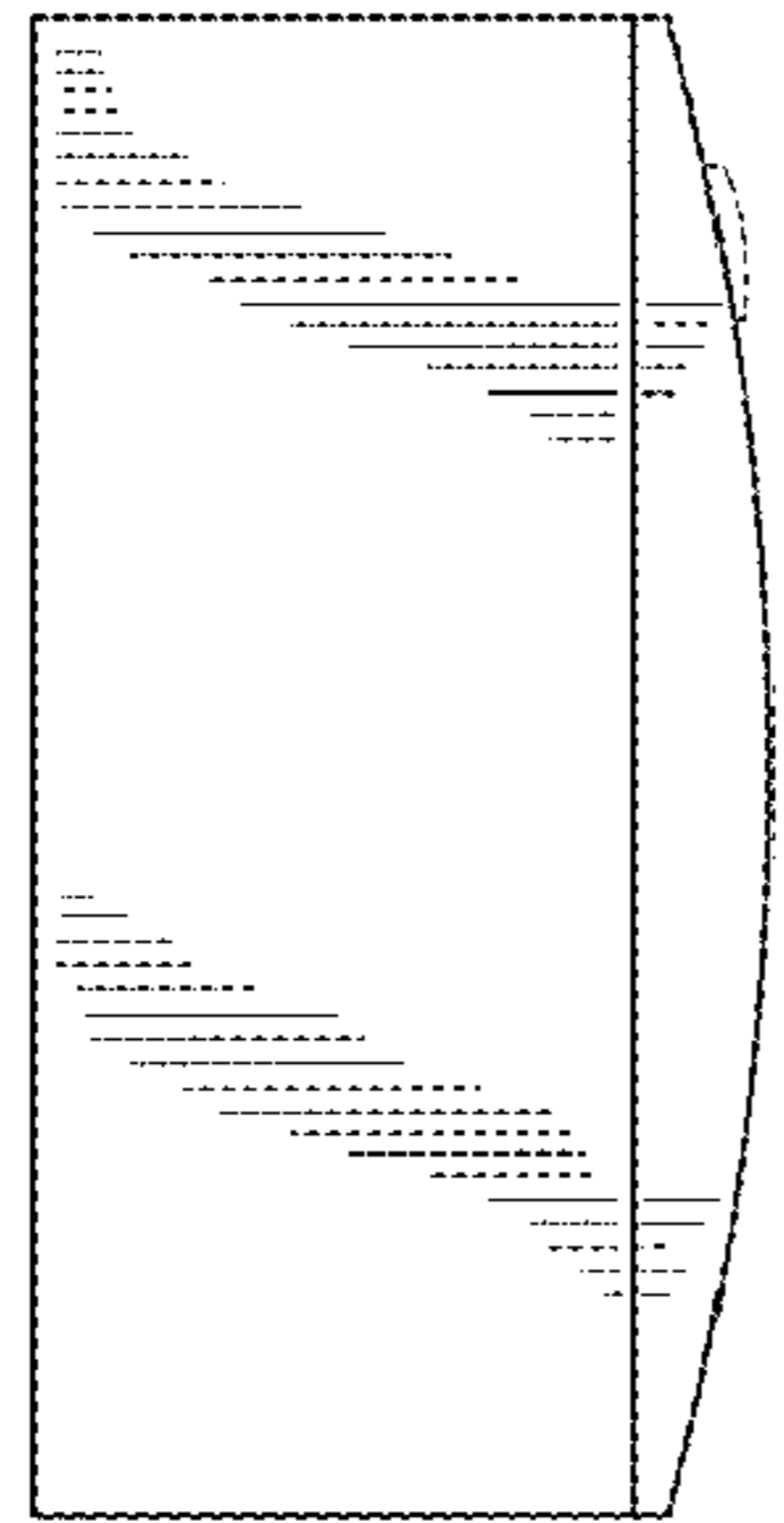

FIG. 3

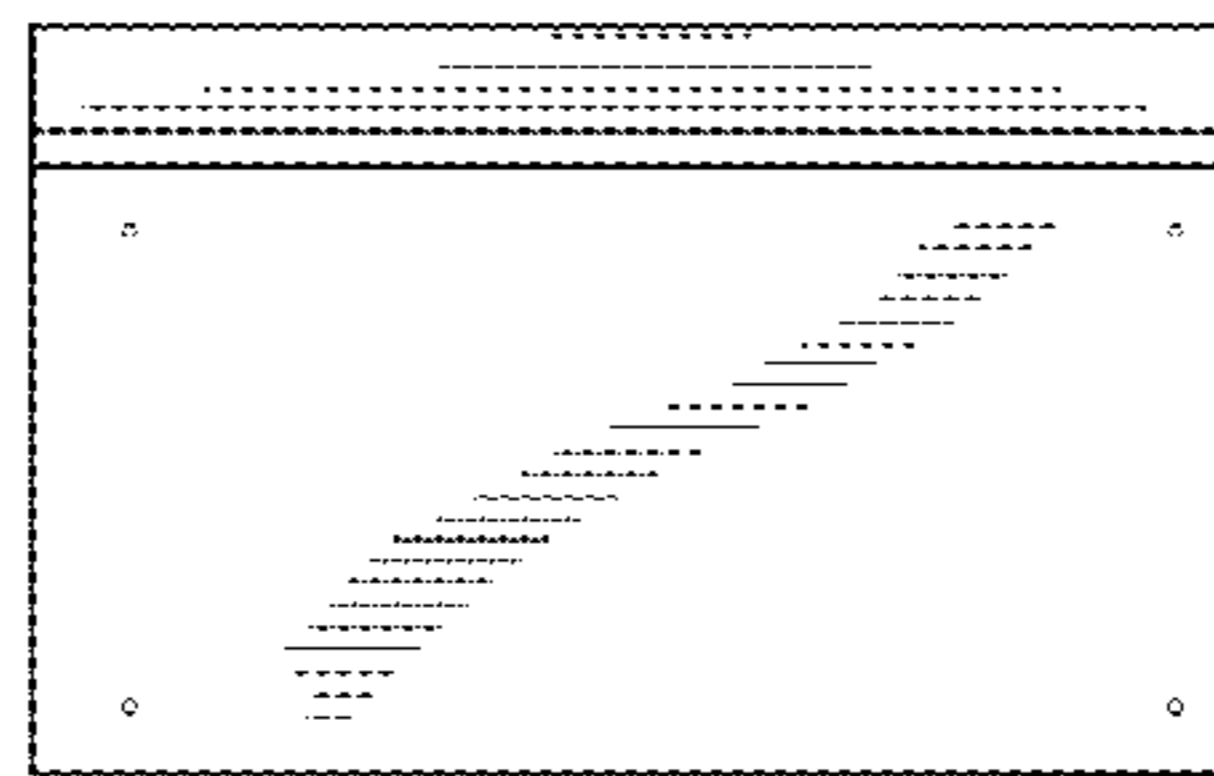

FIG. 4

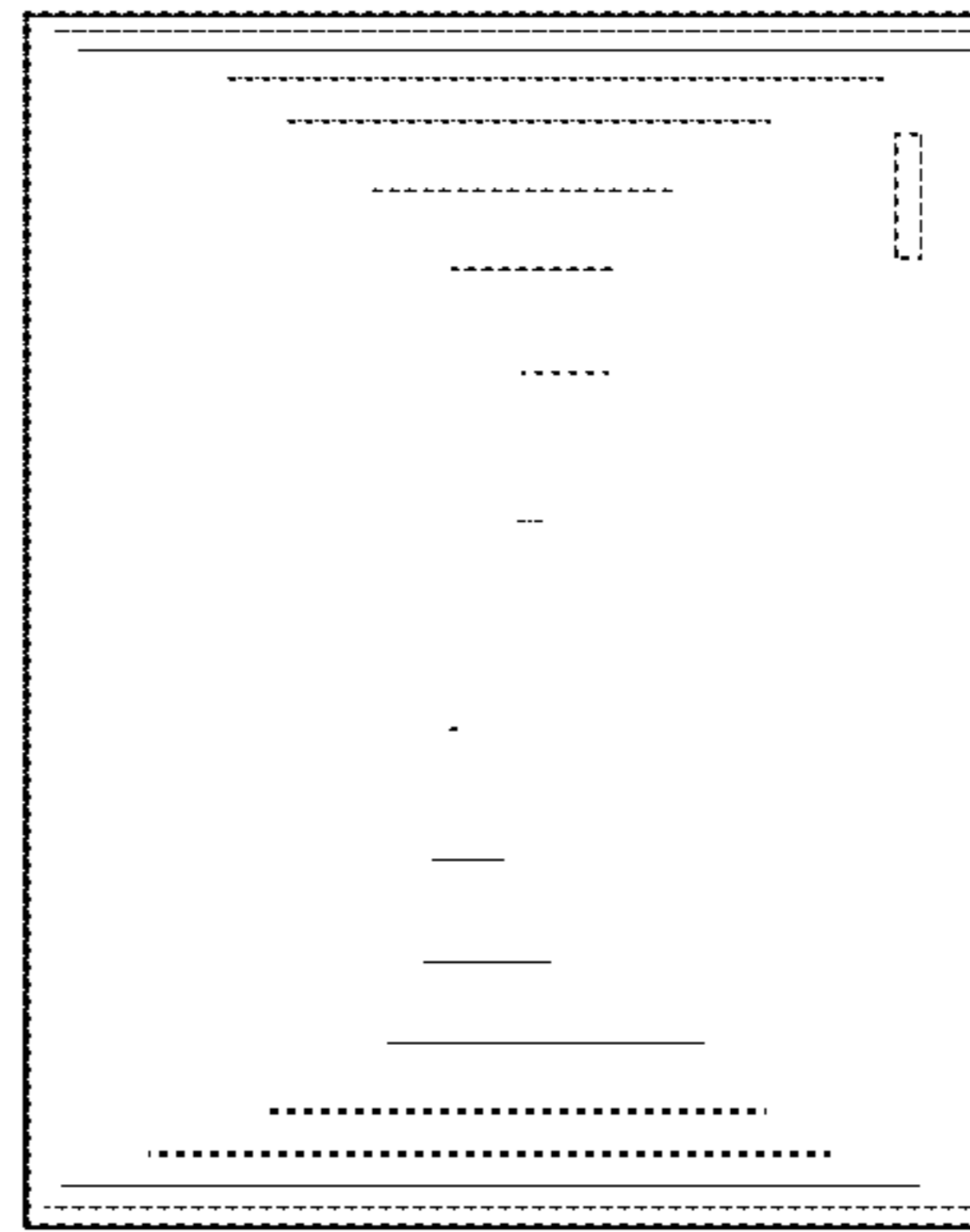

FIG. 5

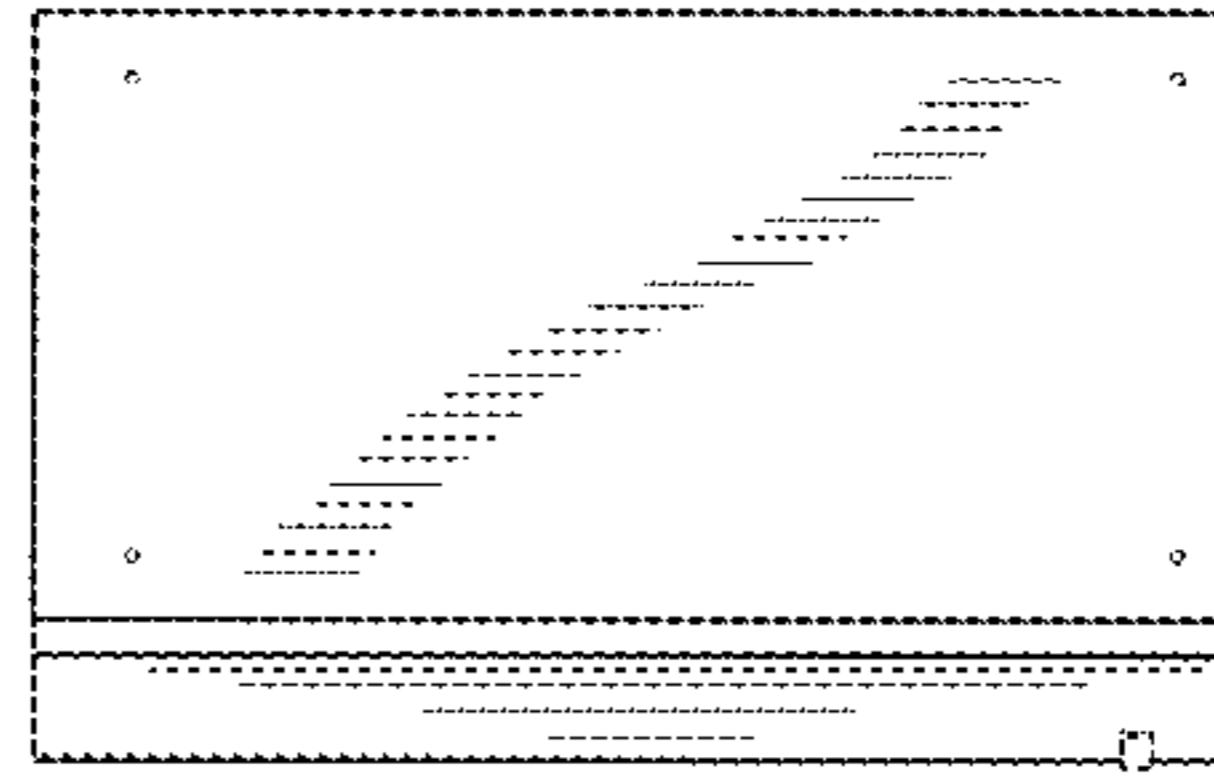
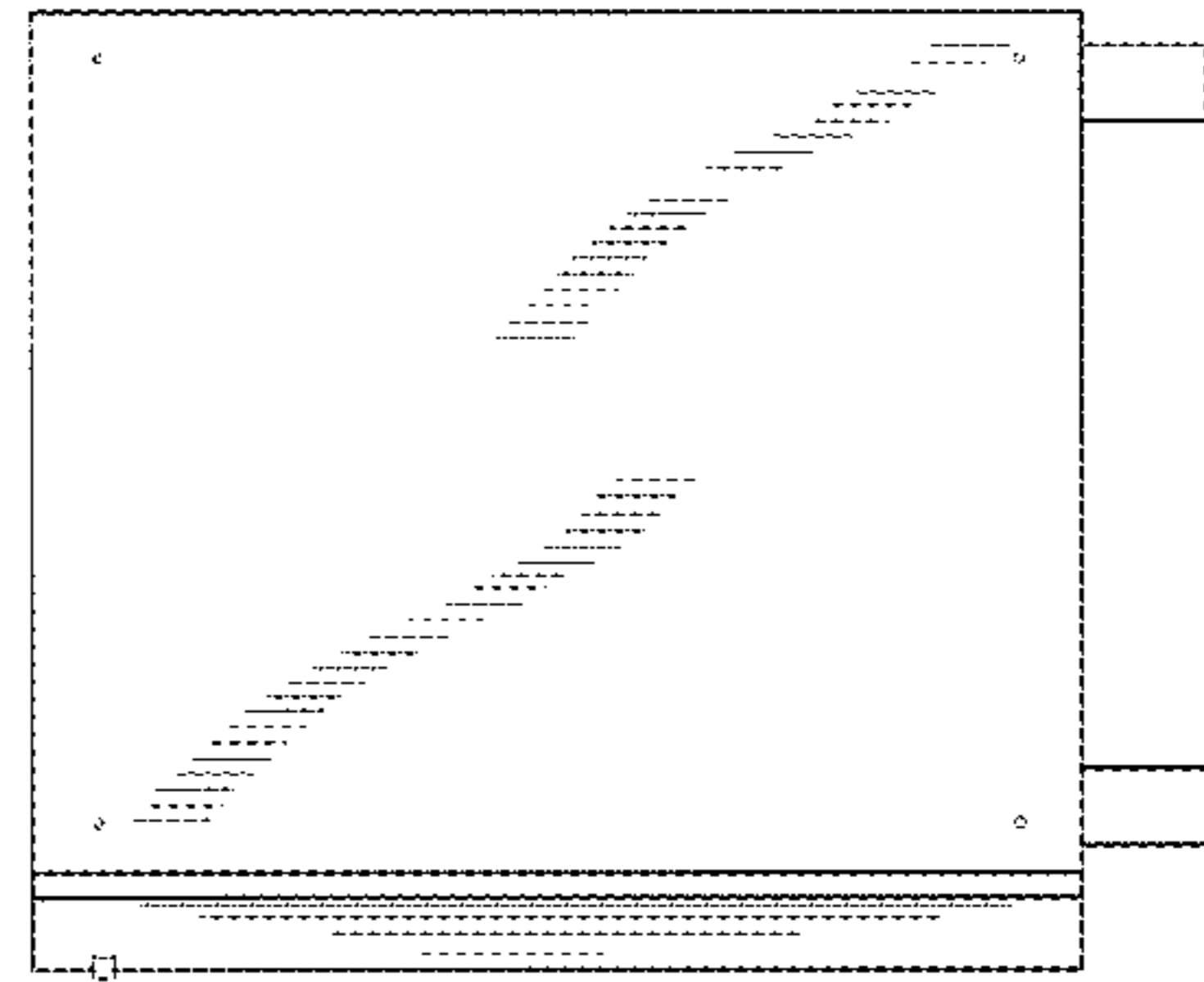
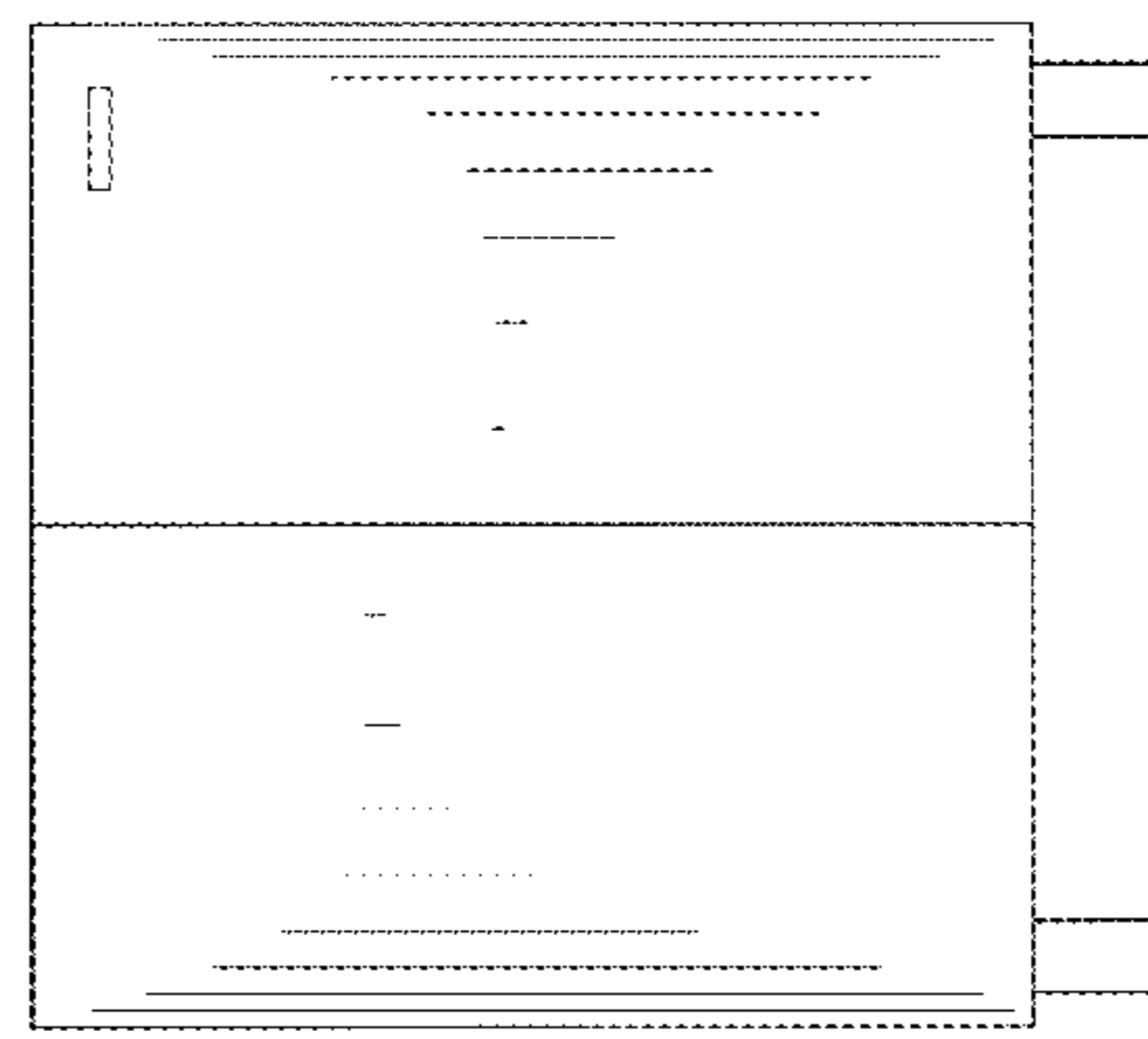
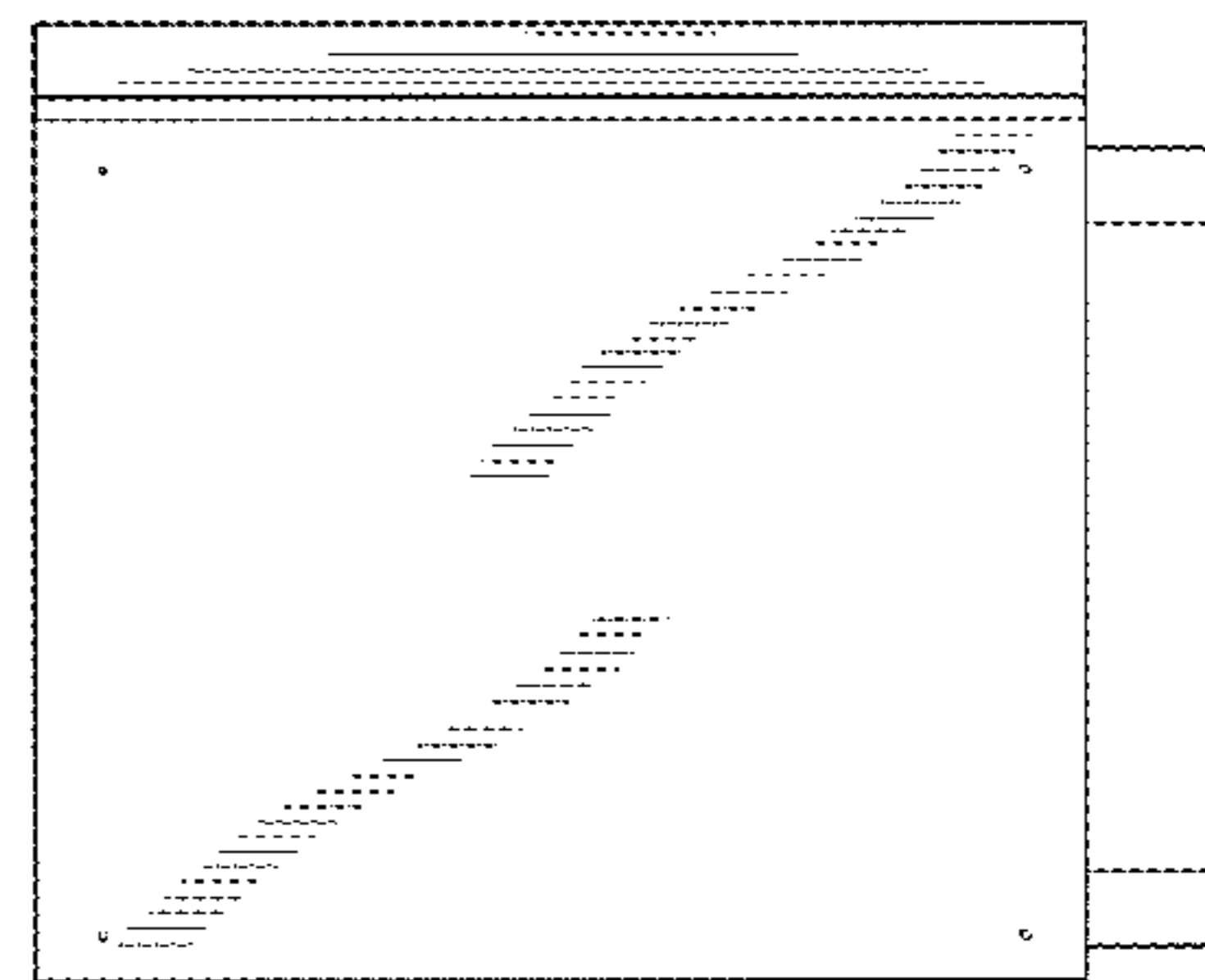
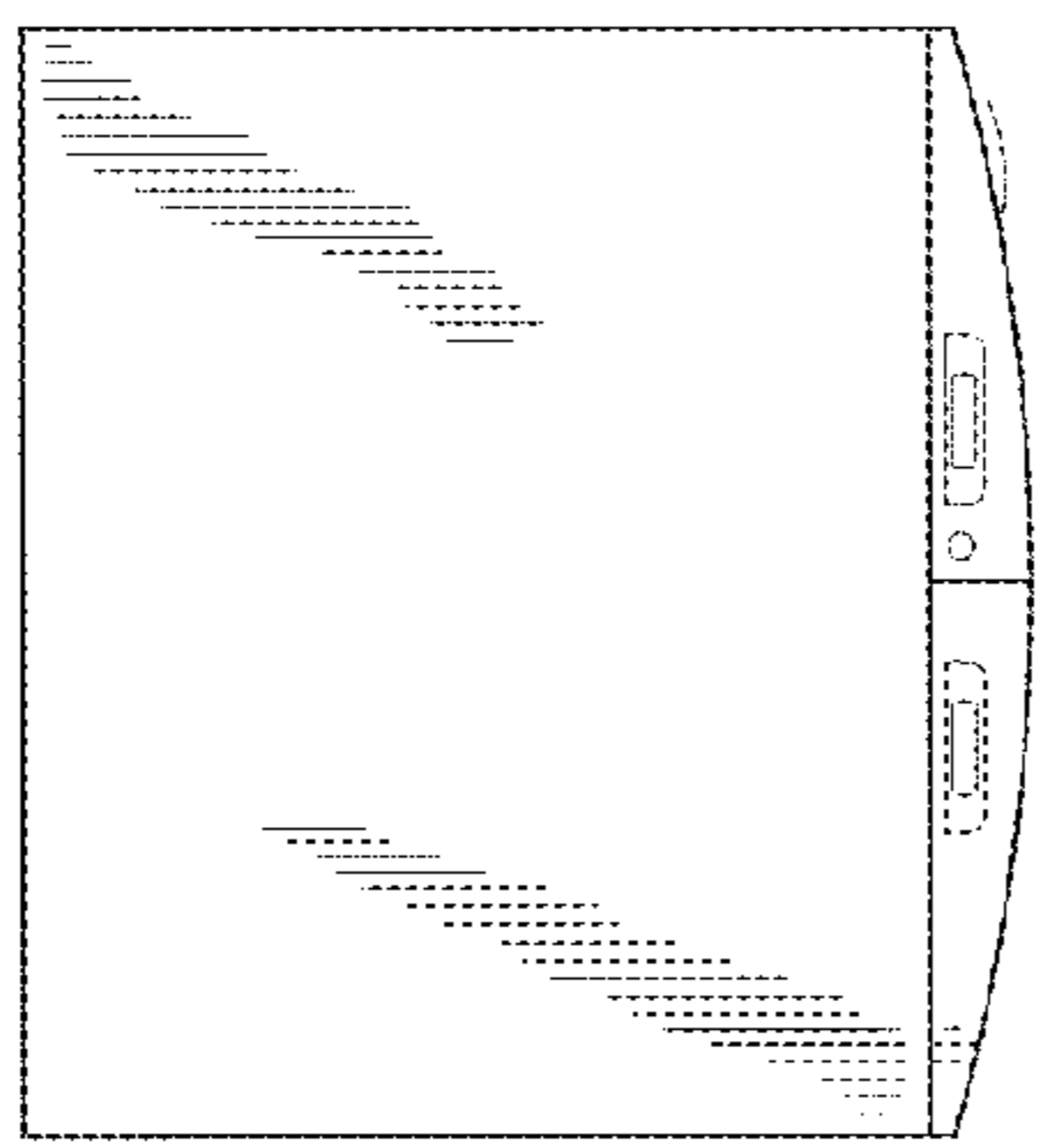
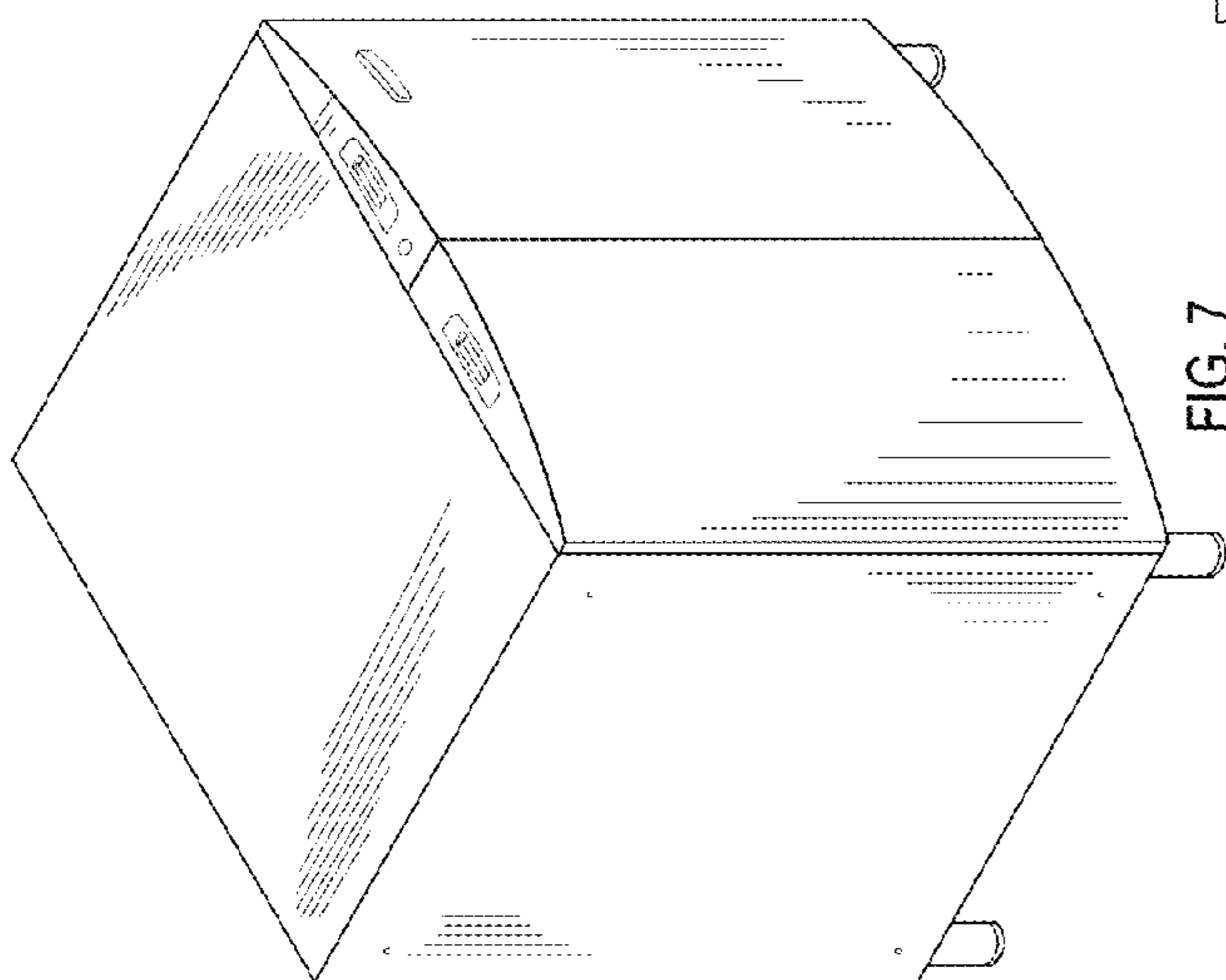

FIG. 6



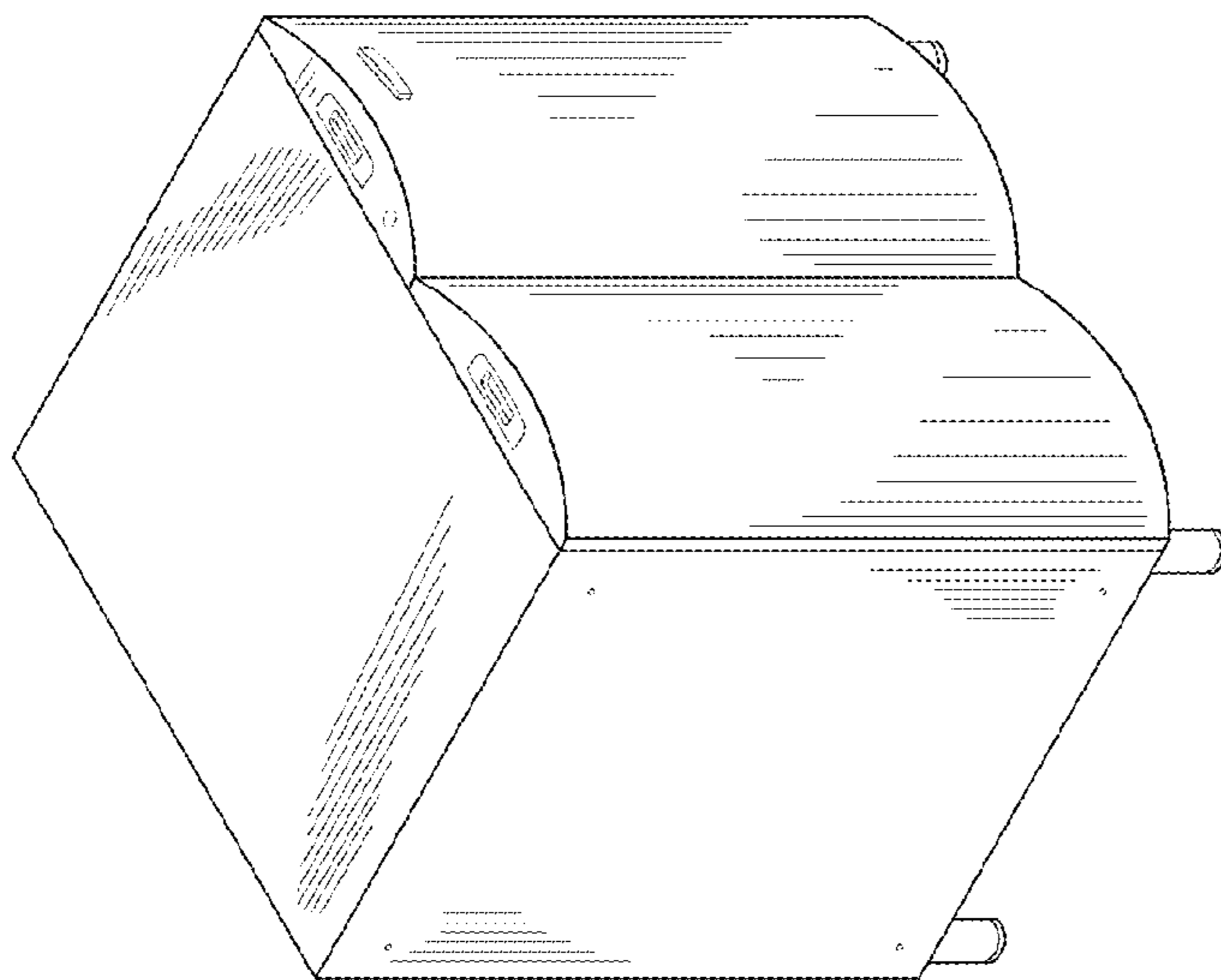

FIG. 12

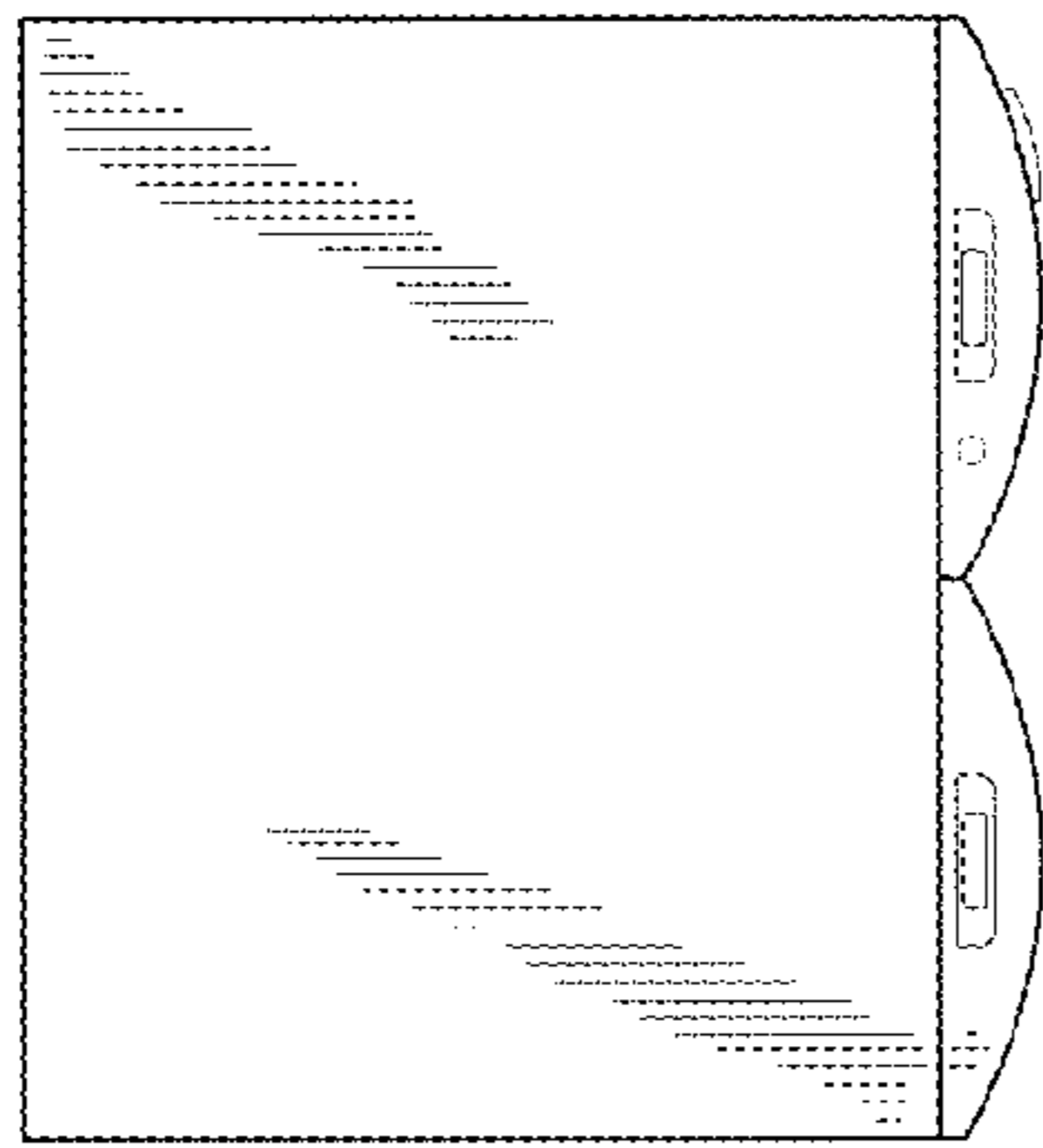

FIG. 13

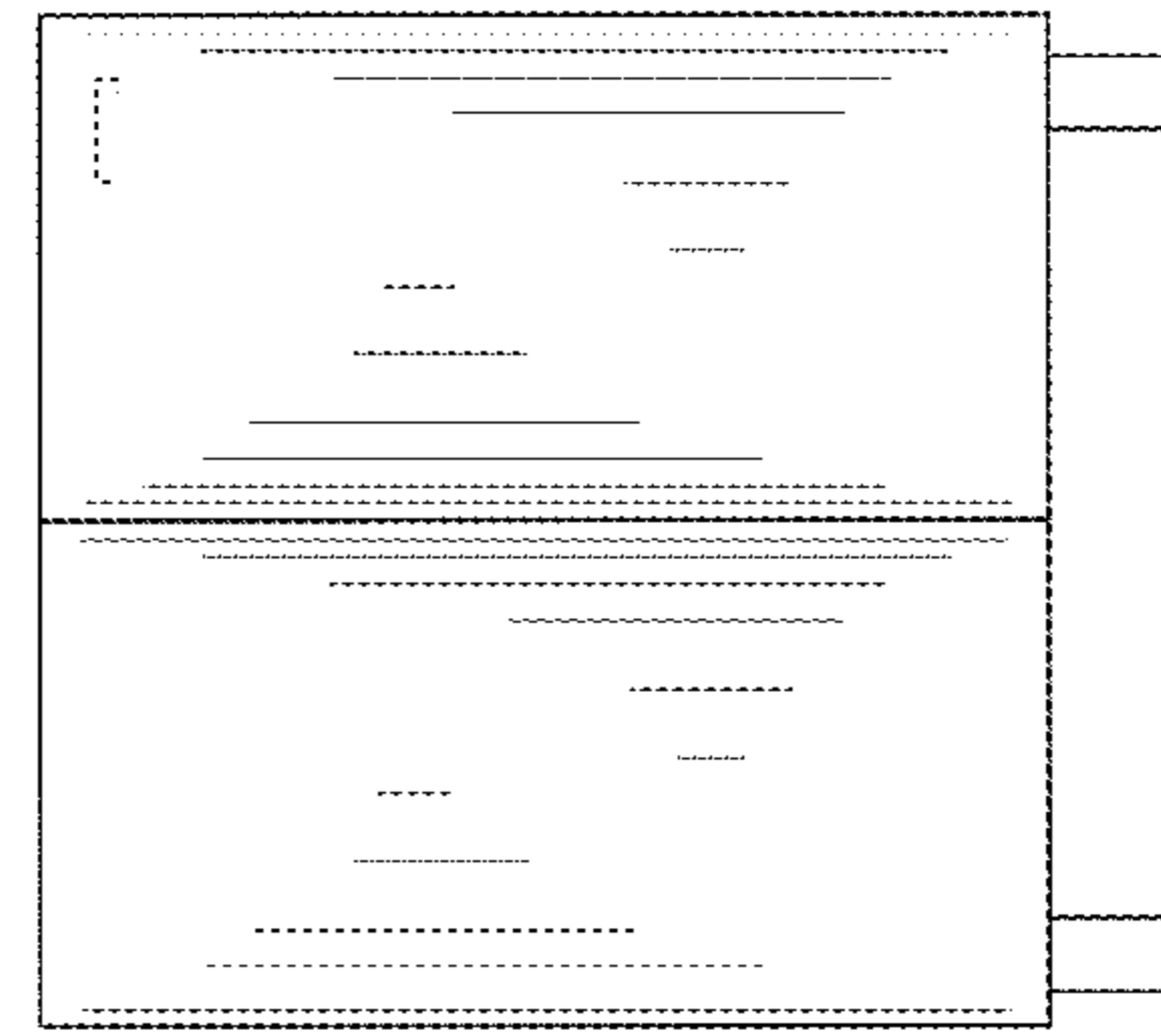

FIG. 14

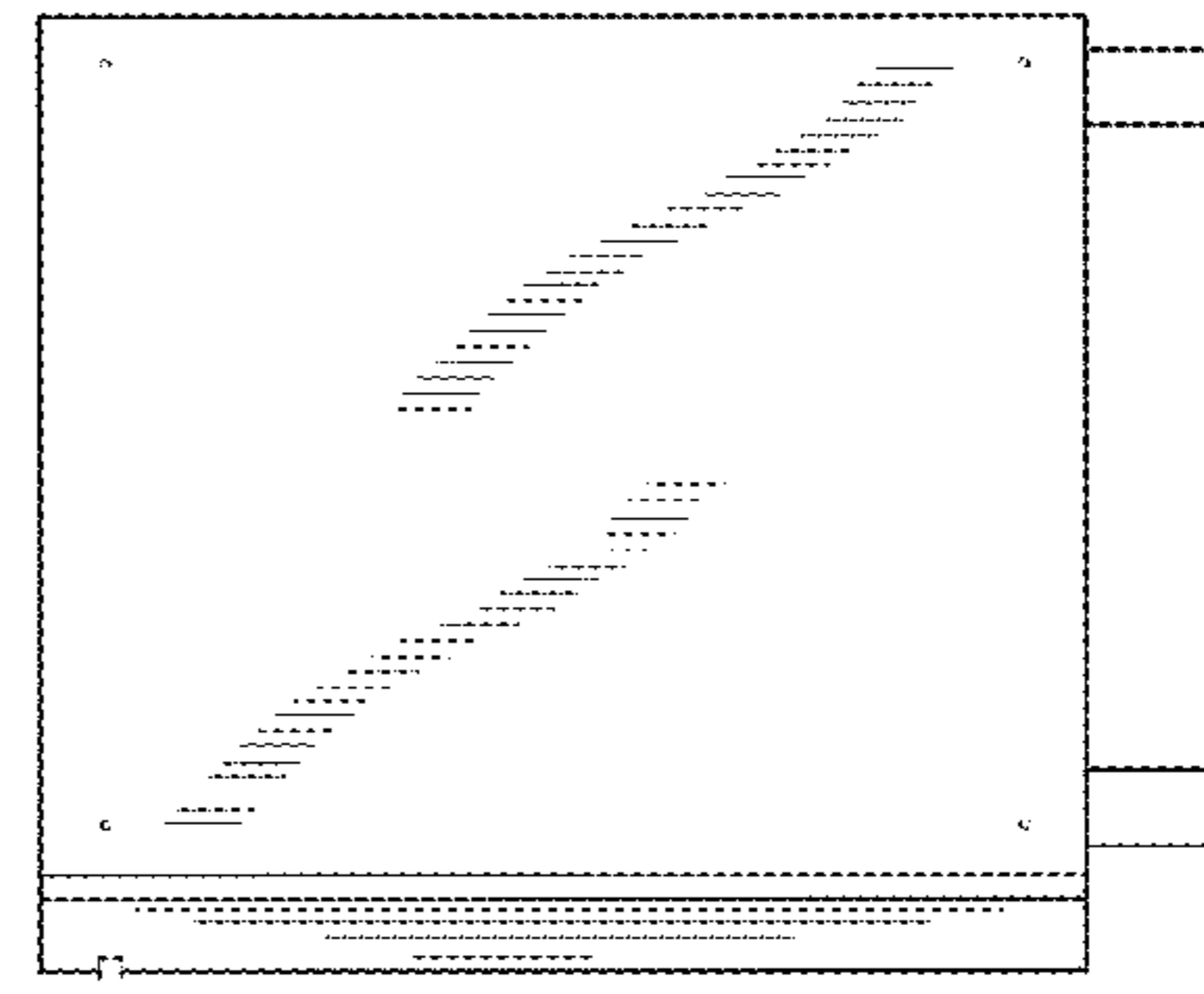

FIG. 15

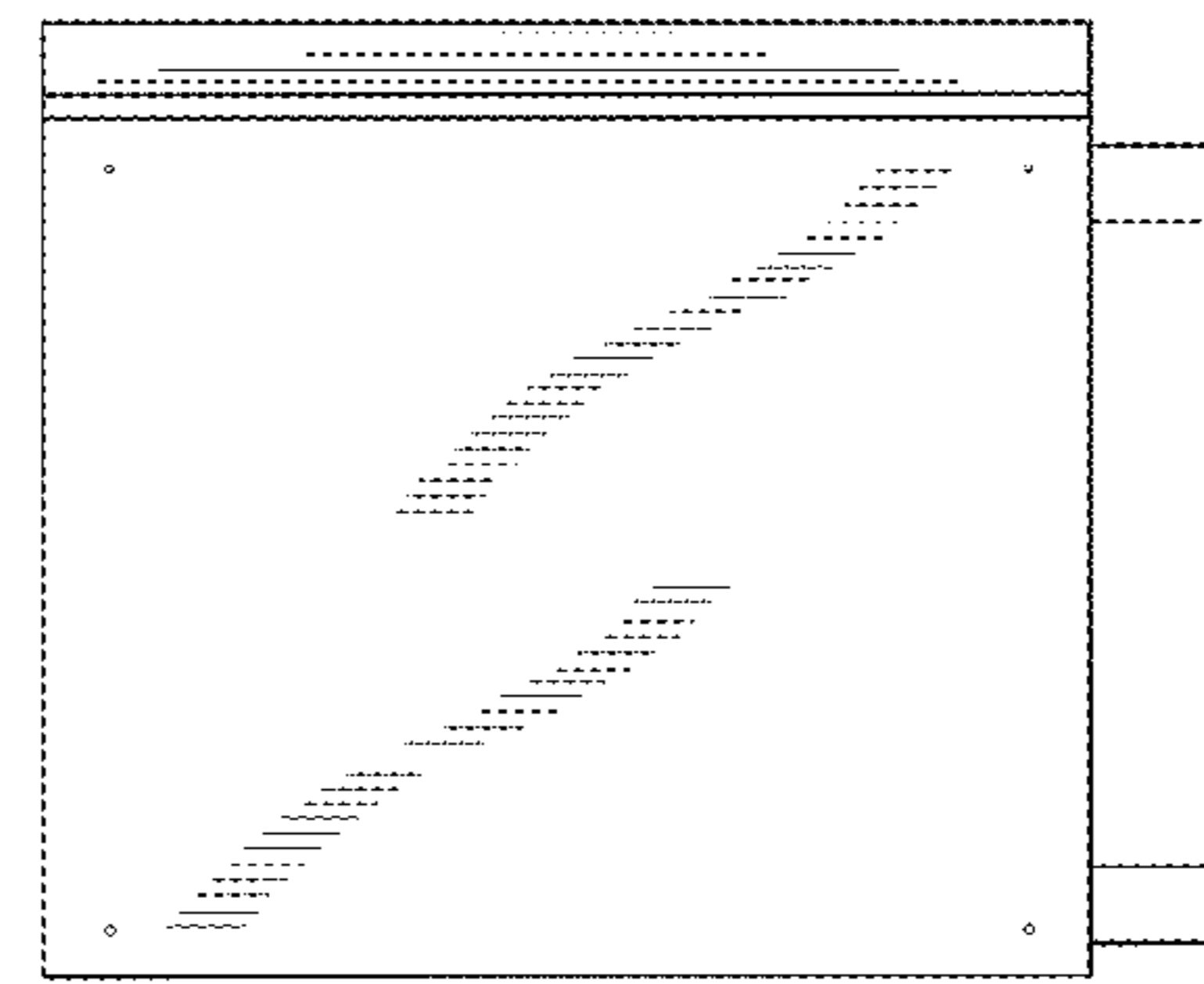

FIG. 16

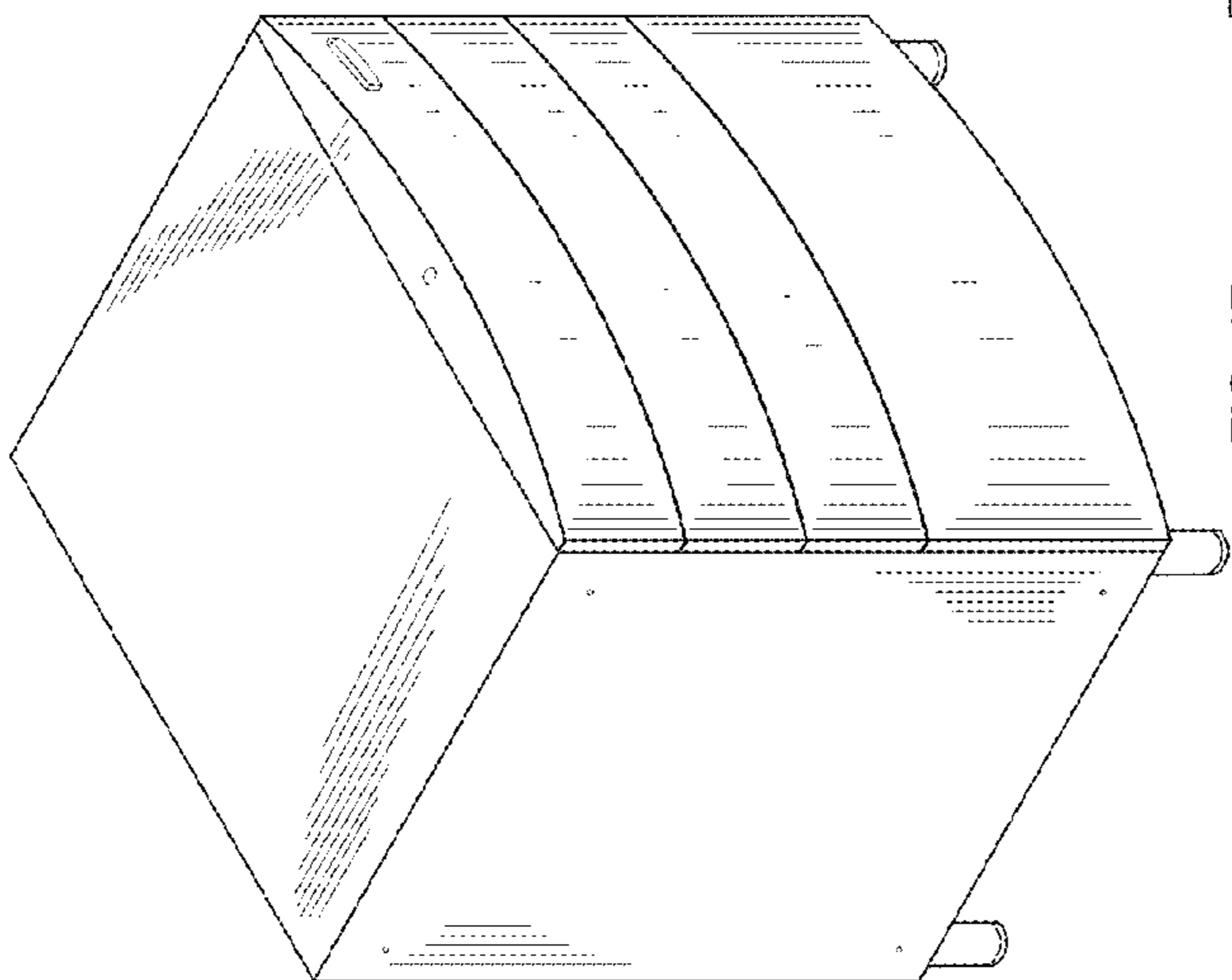

FIG. 17

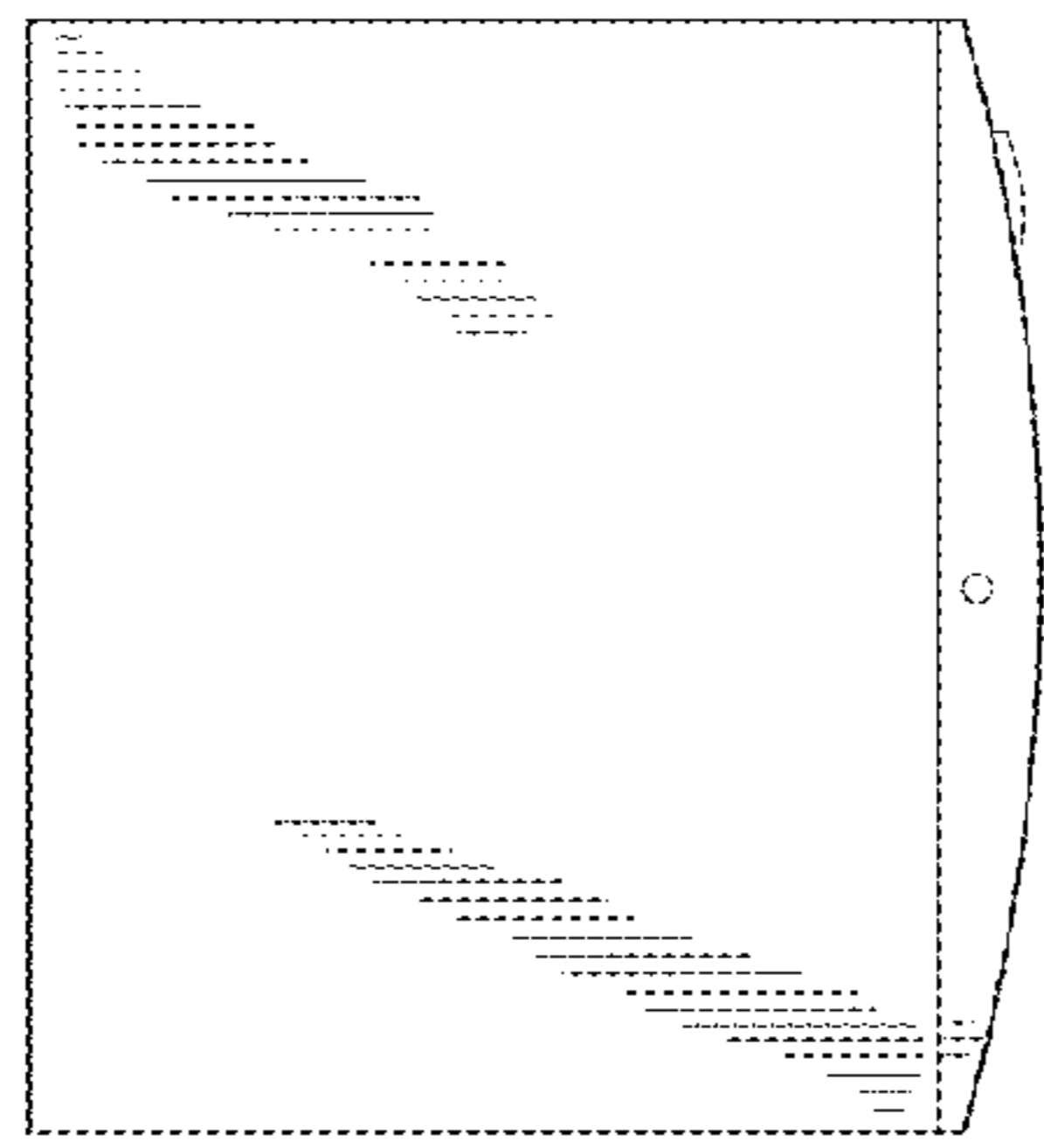

FIG. 18

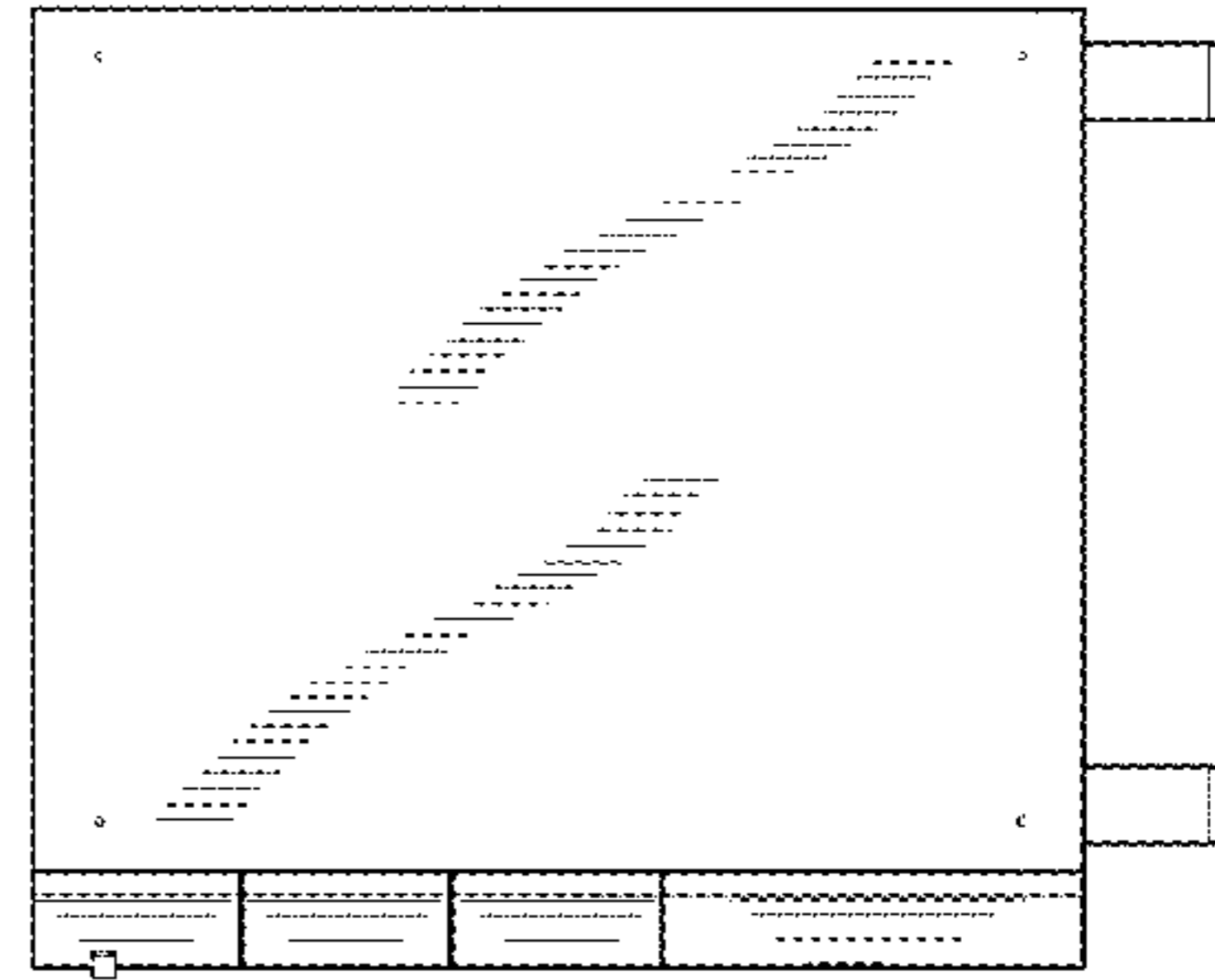

FIG. 19

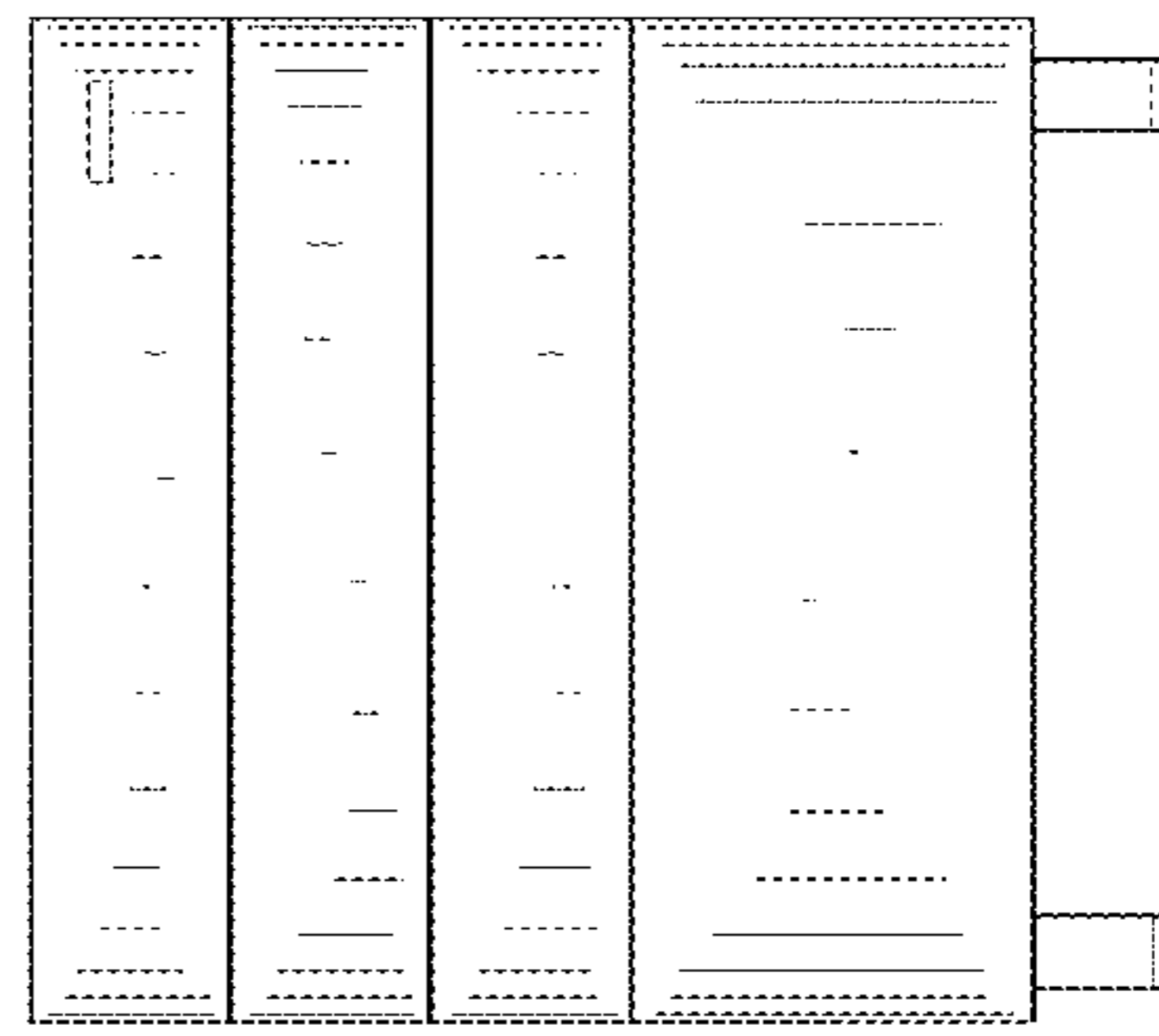

FIG. 20

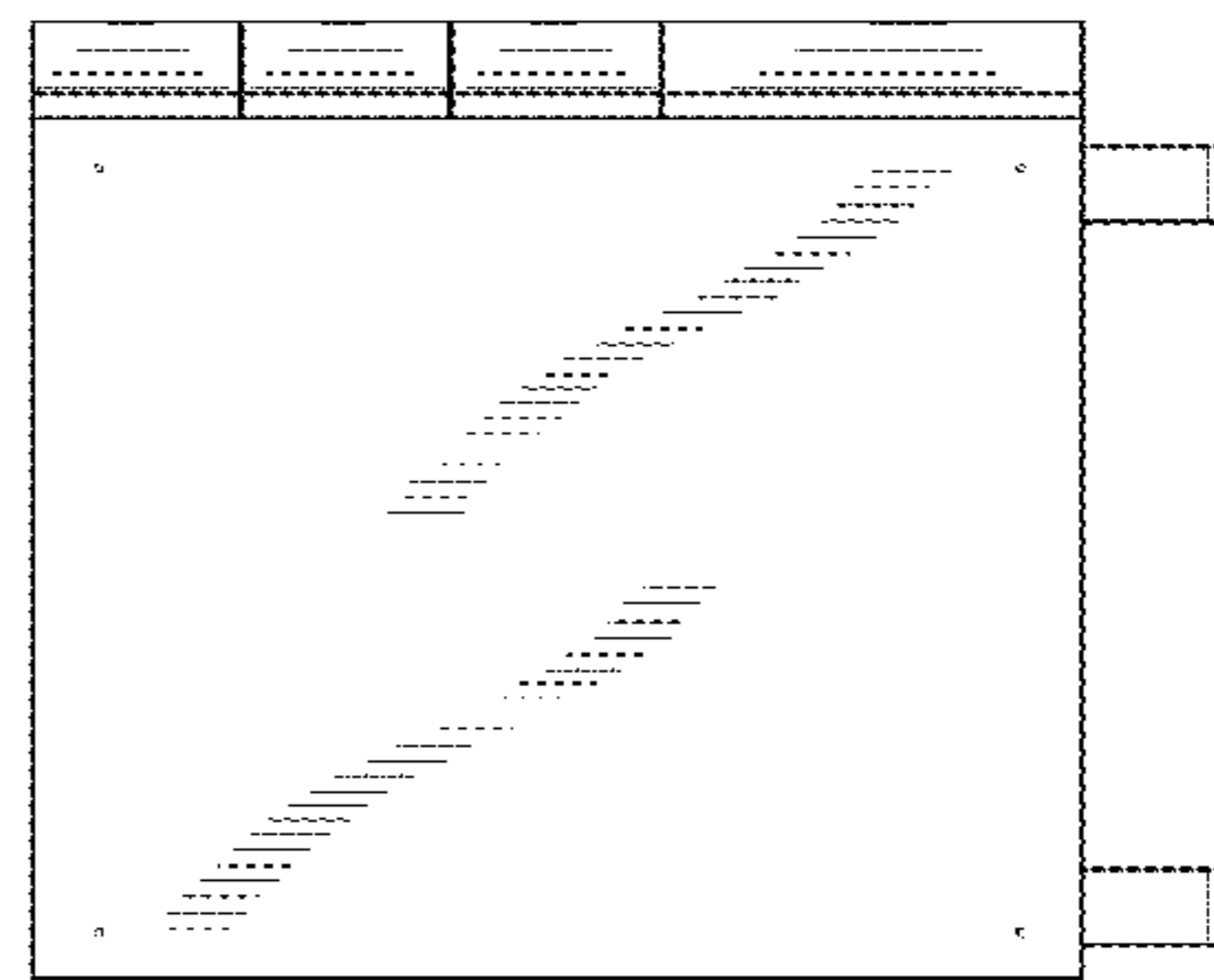
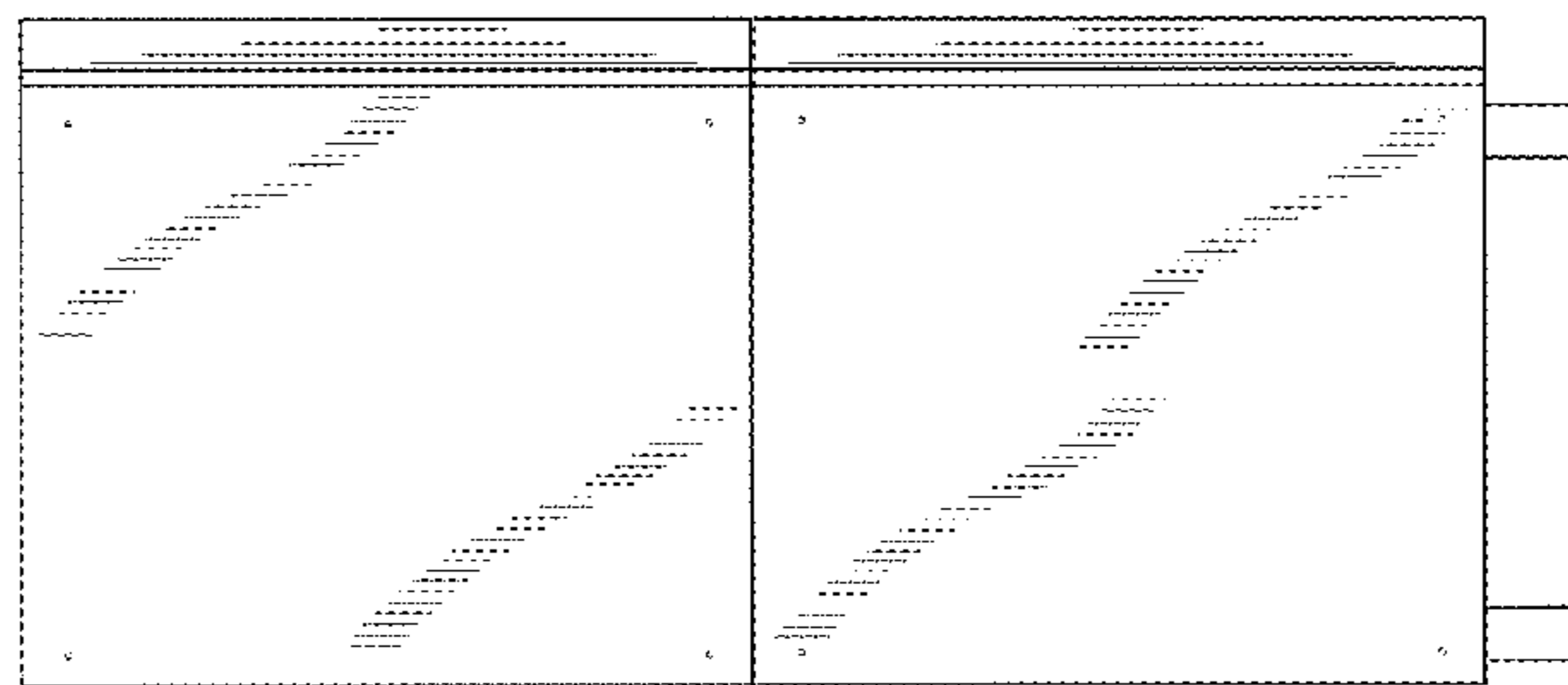
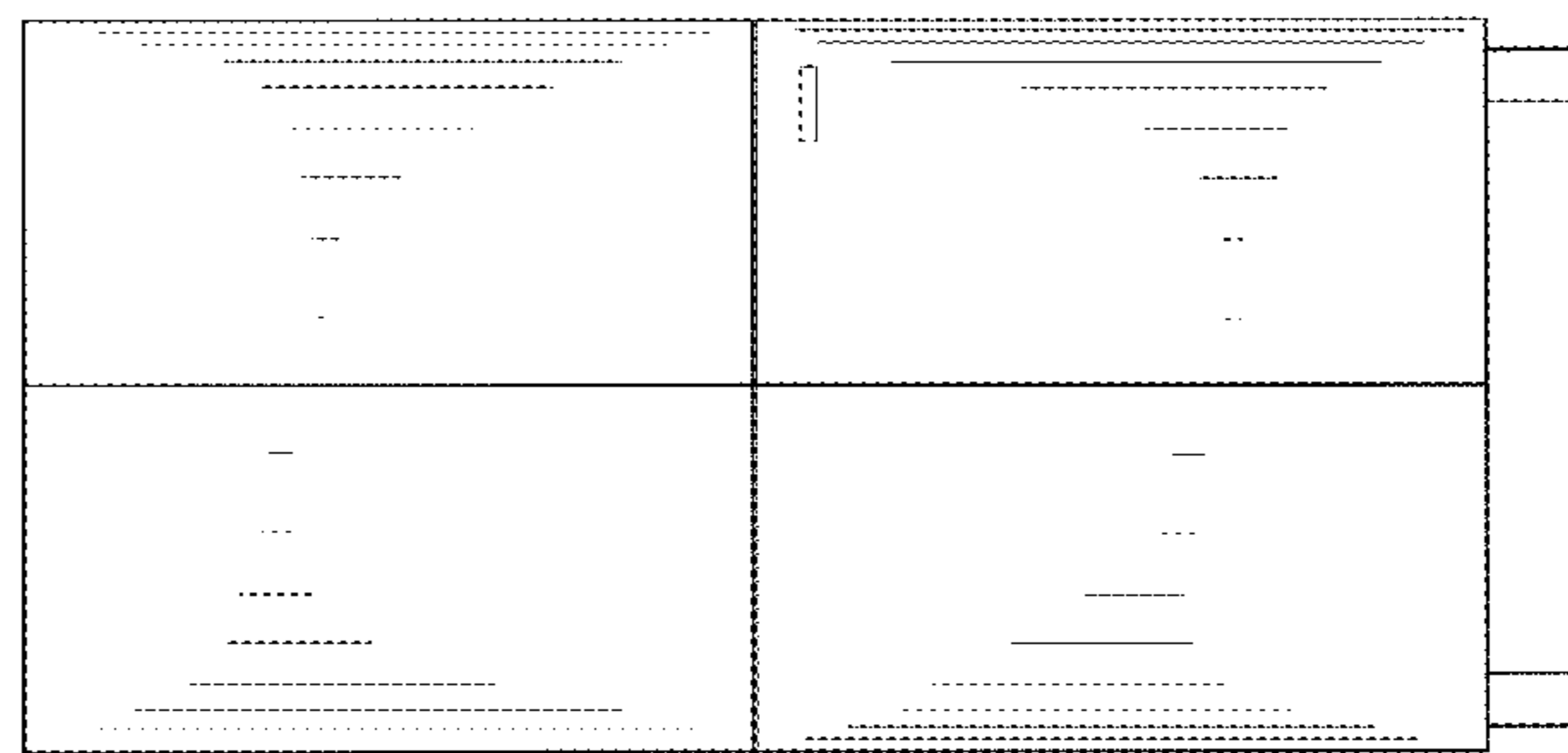
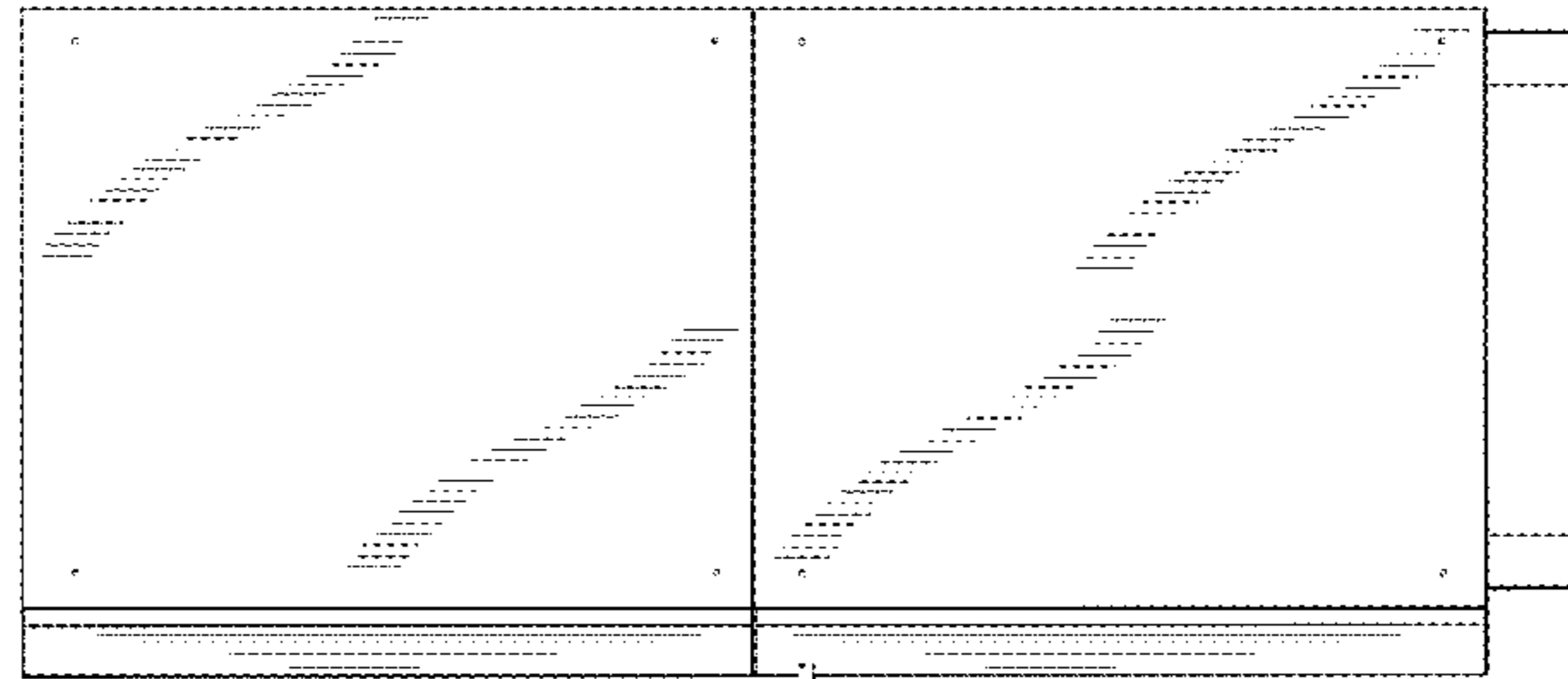
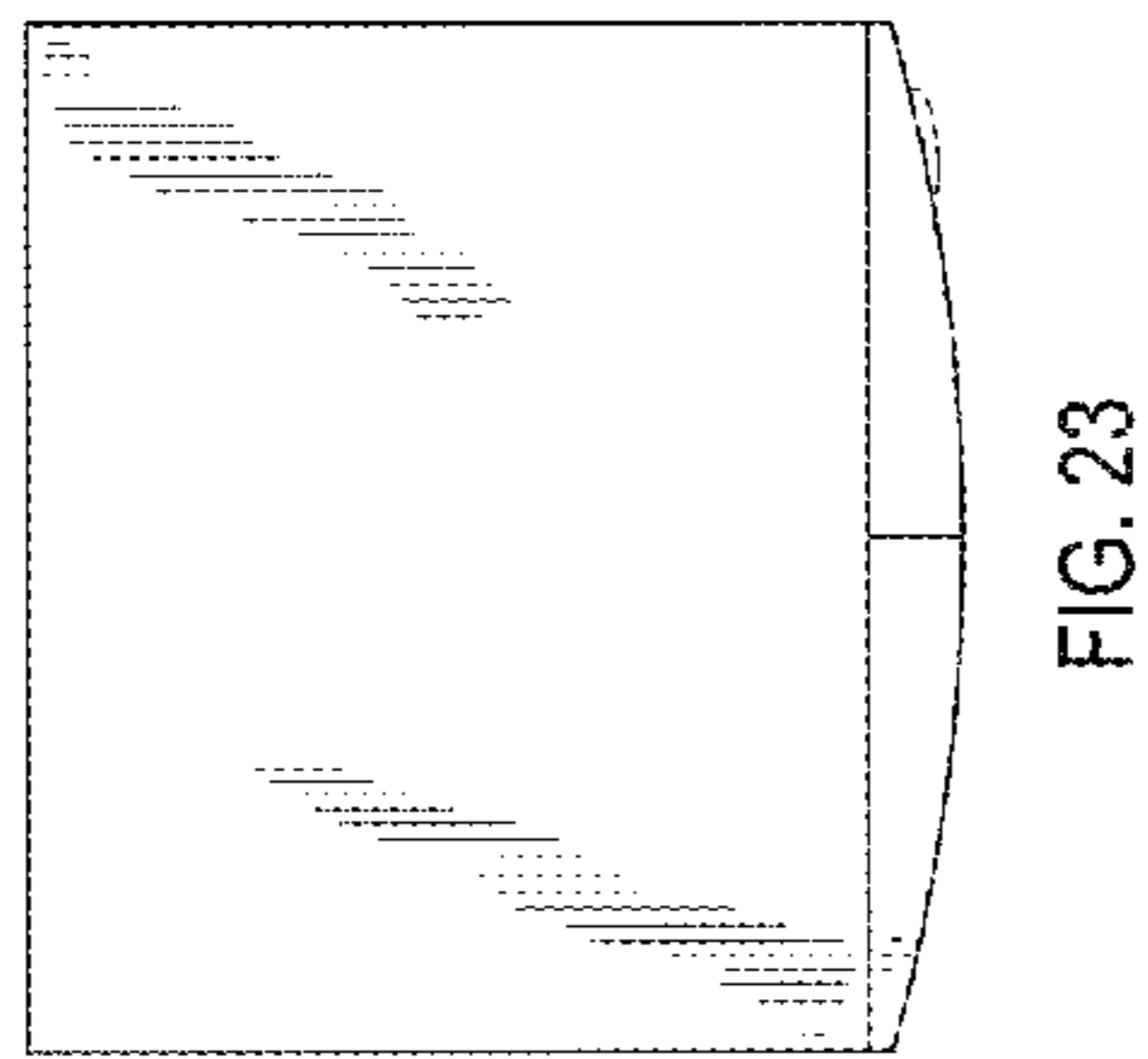
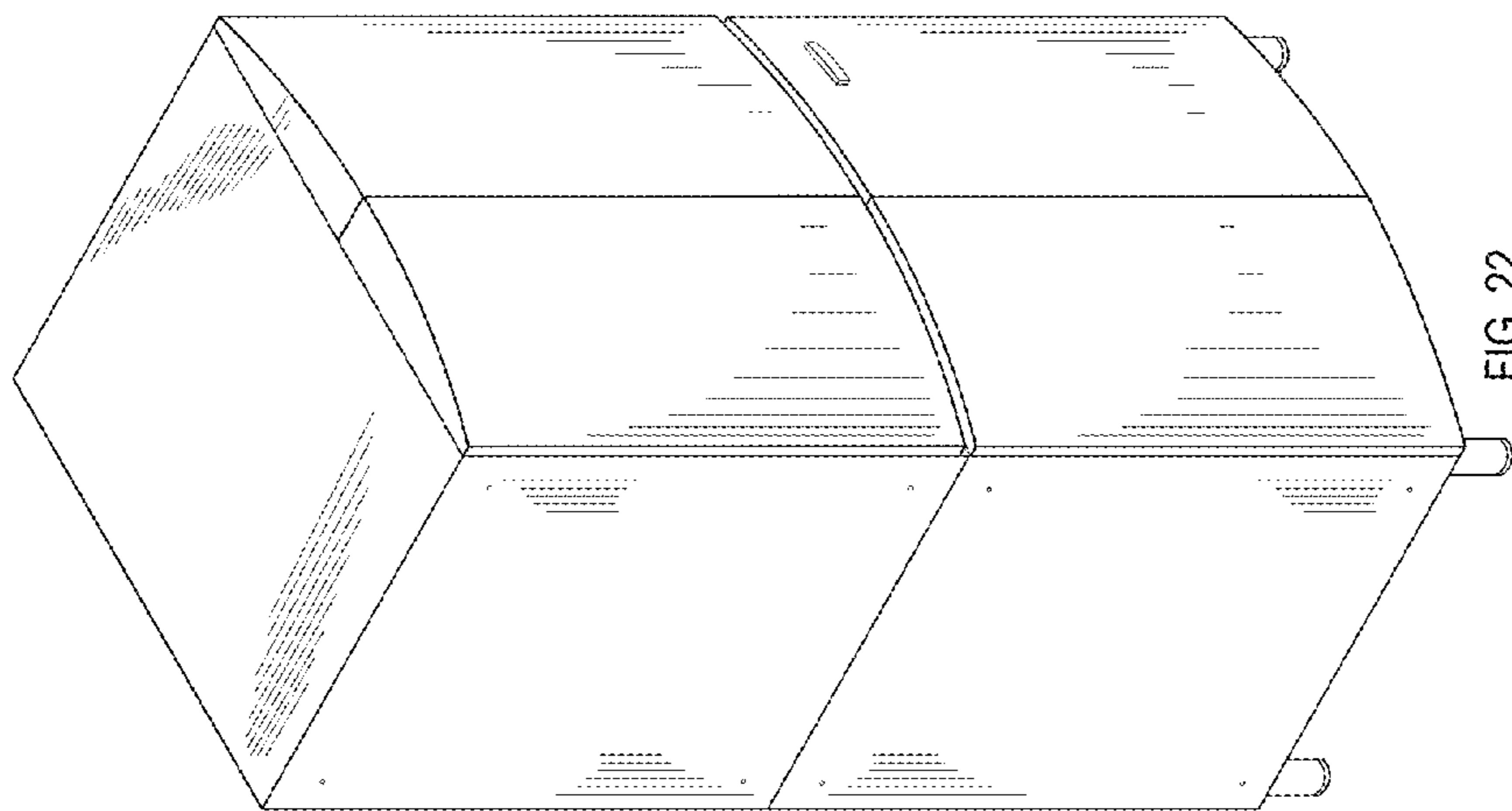

FIG. 21



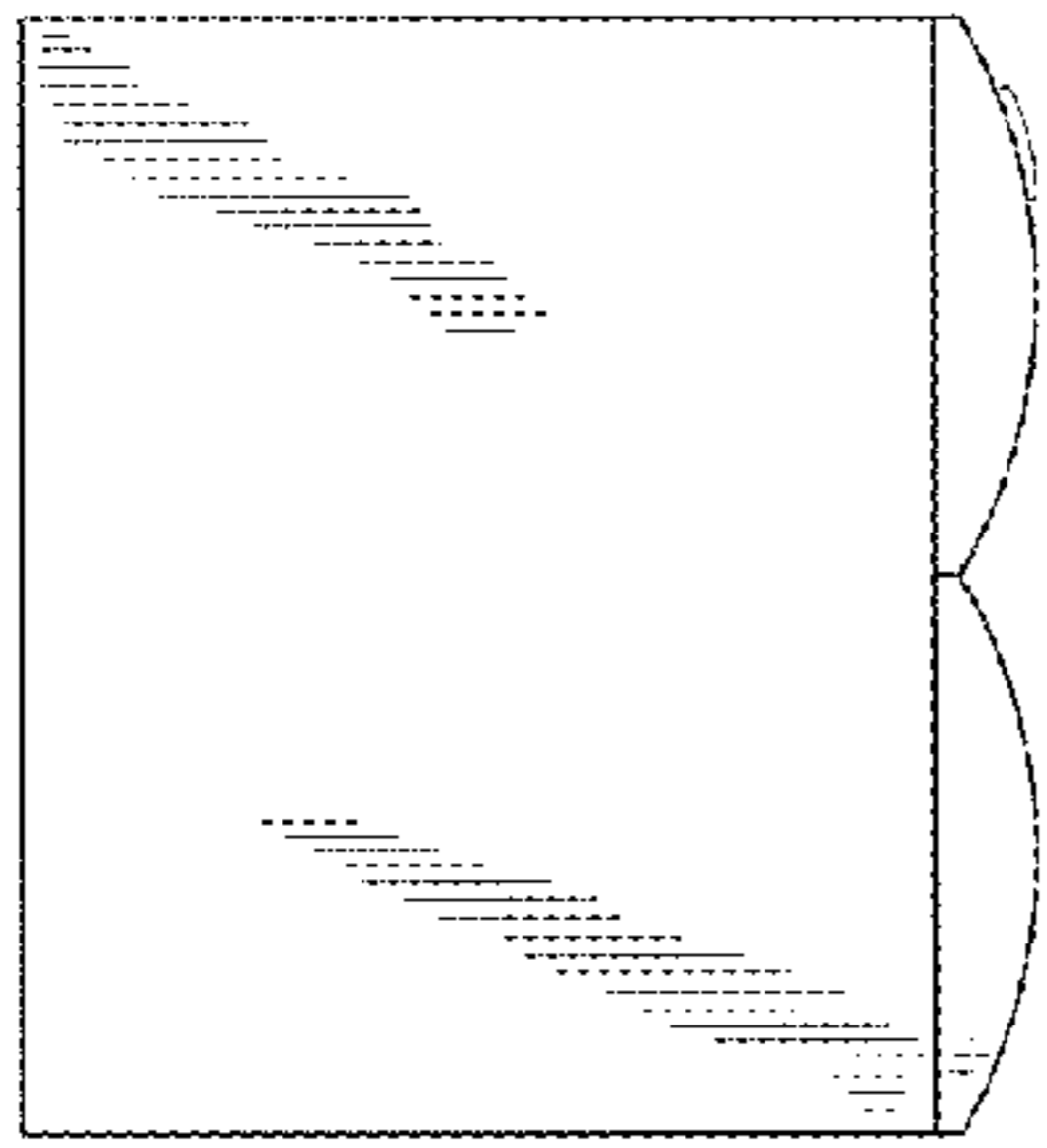
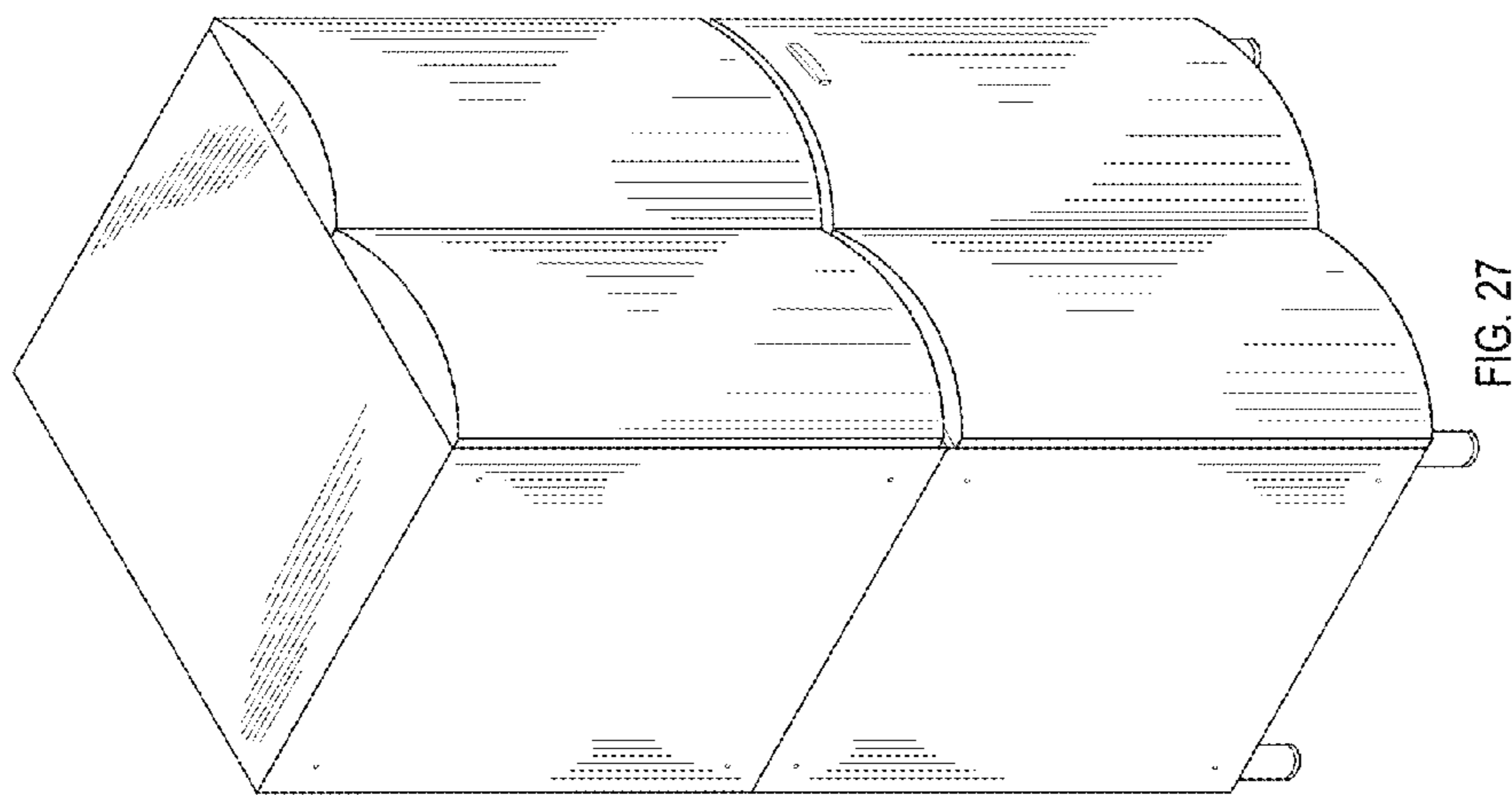

FIG. 28

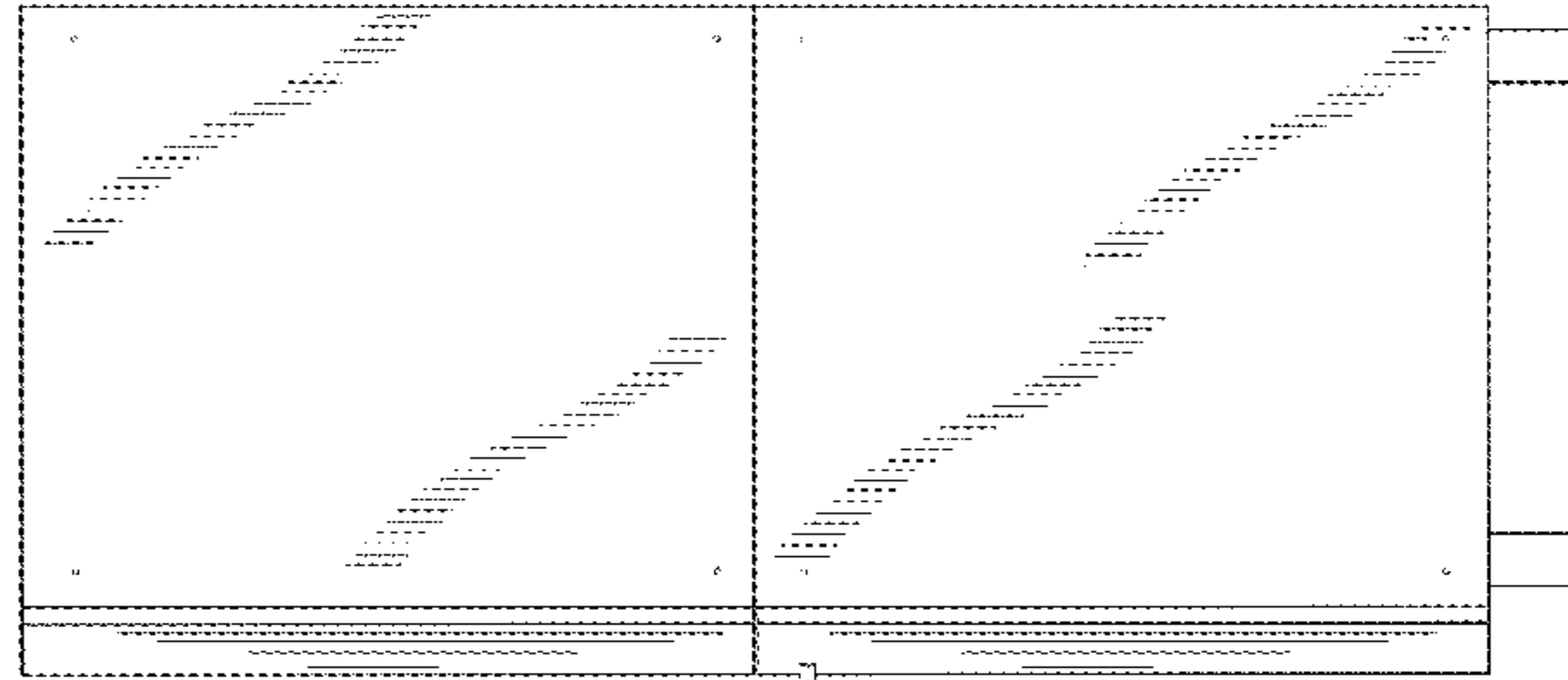

FIG. 31

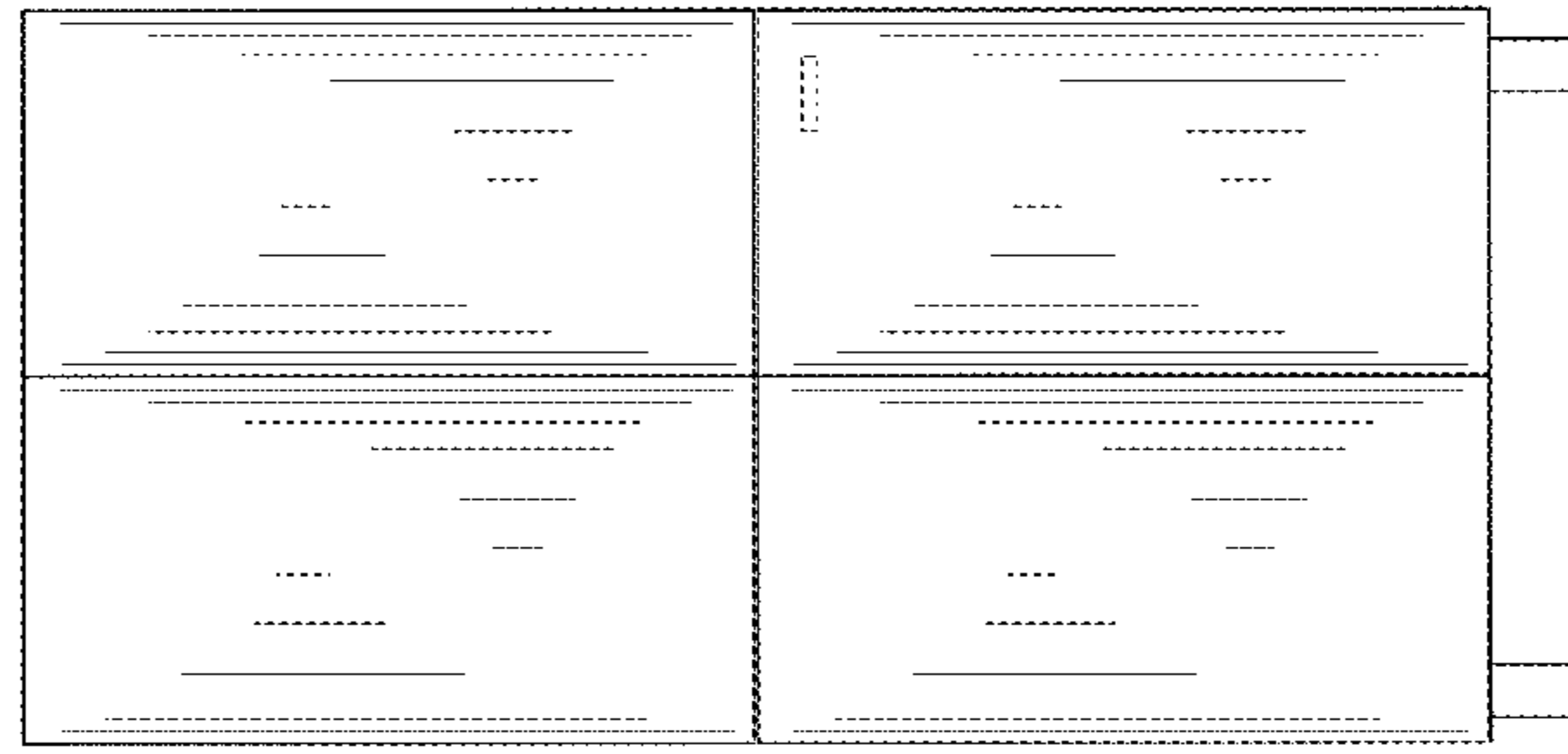

FIG. 30

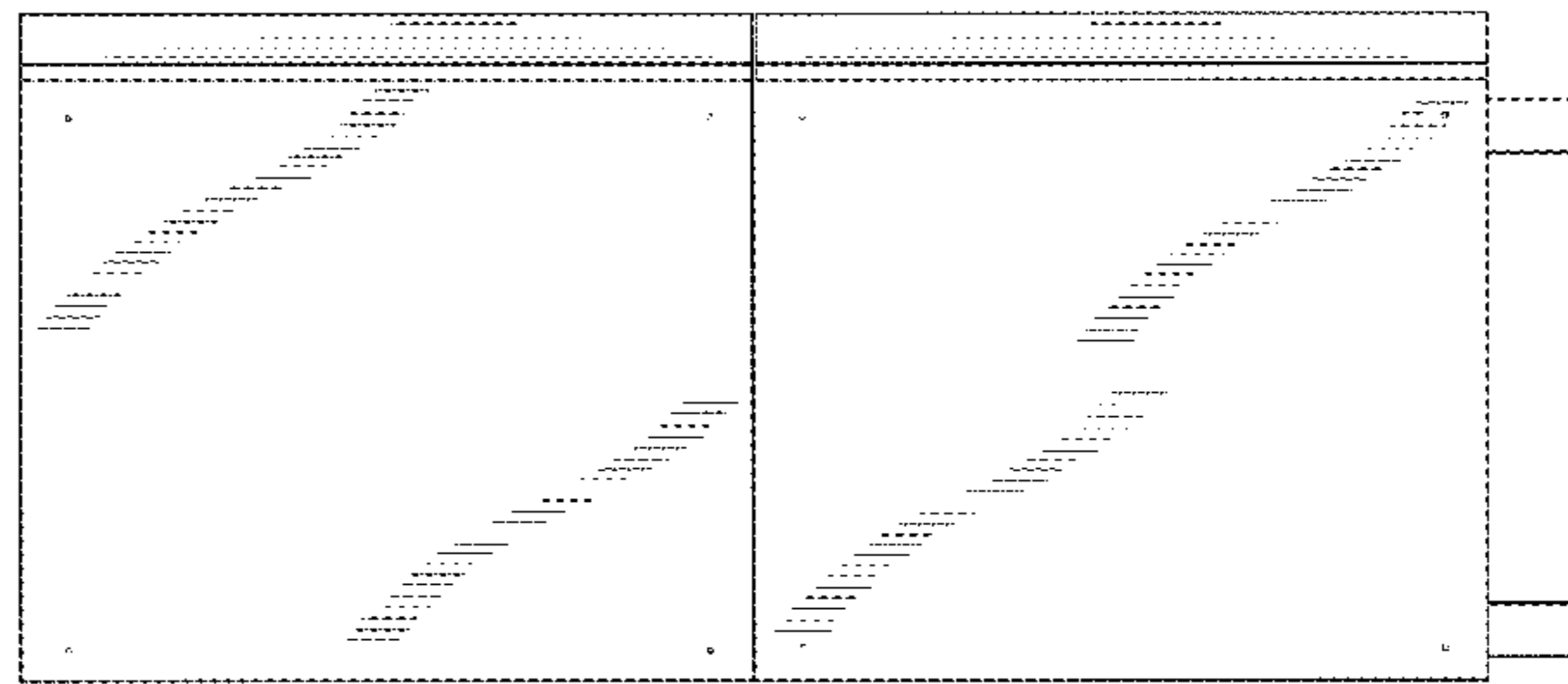

FIG. 29

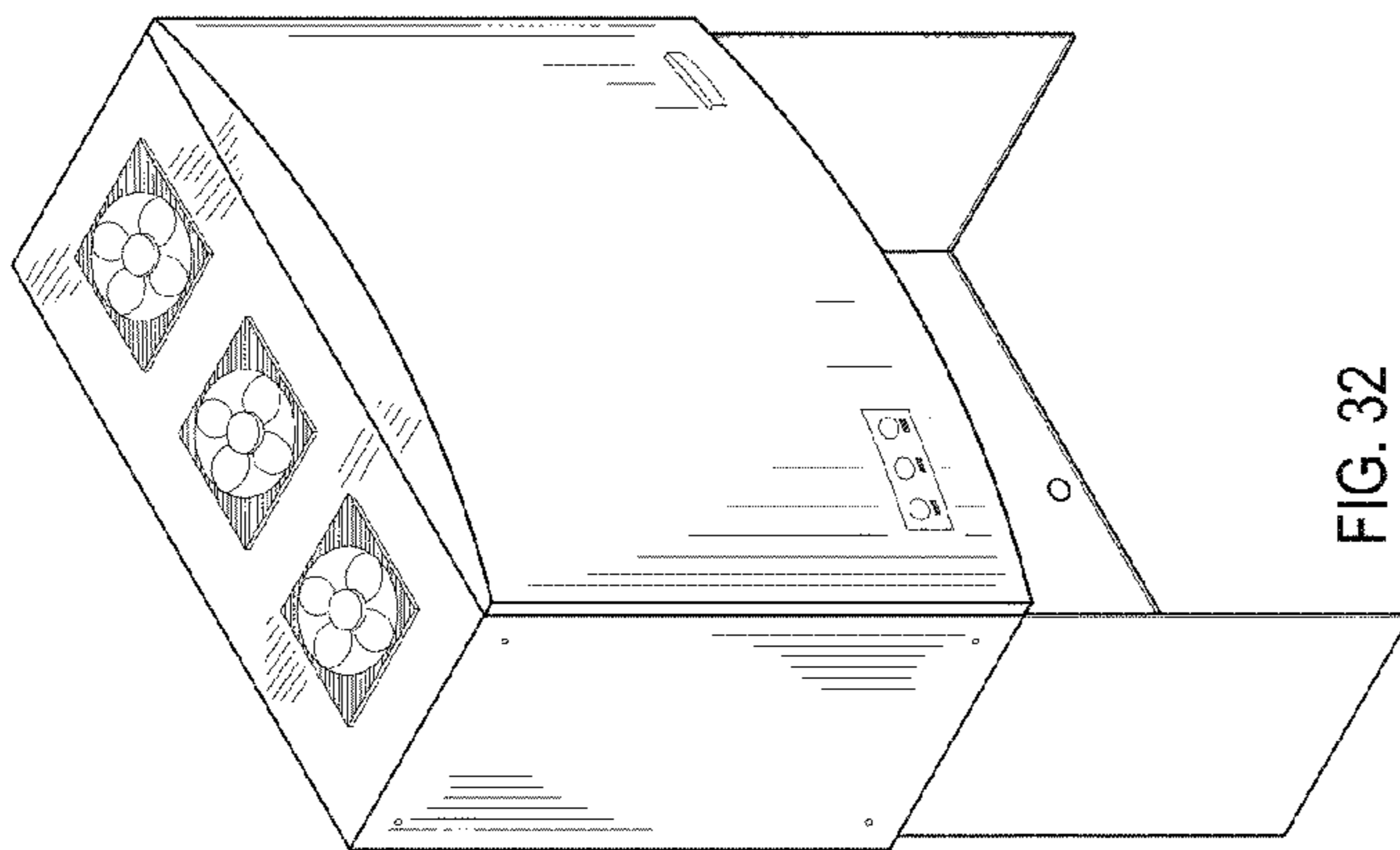

FIG. 32

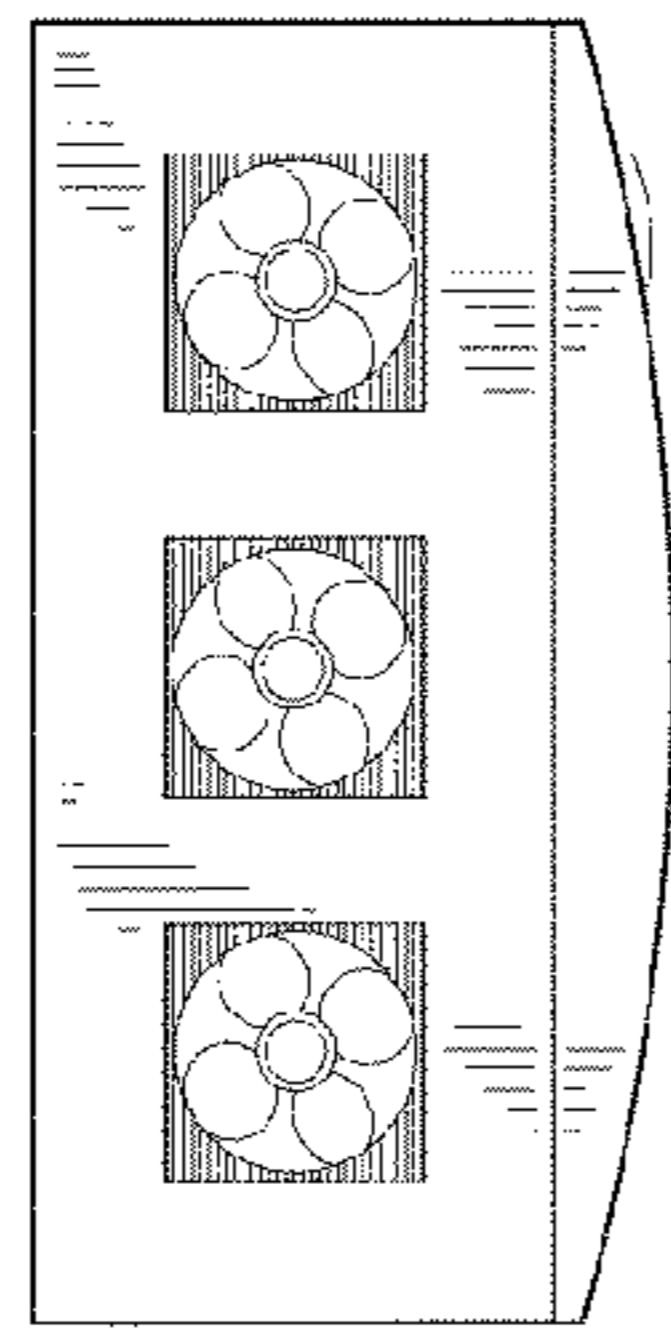

FIG. 33

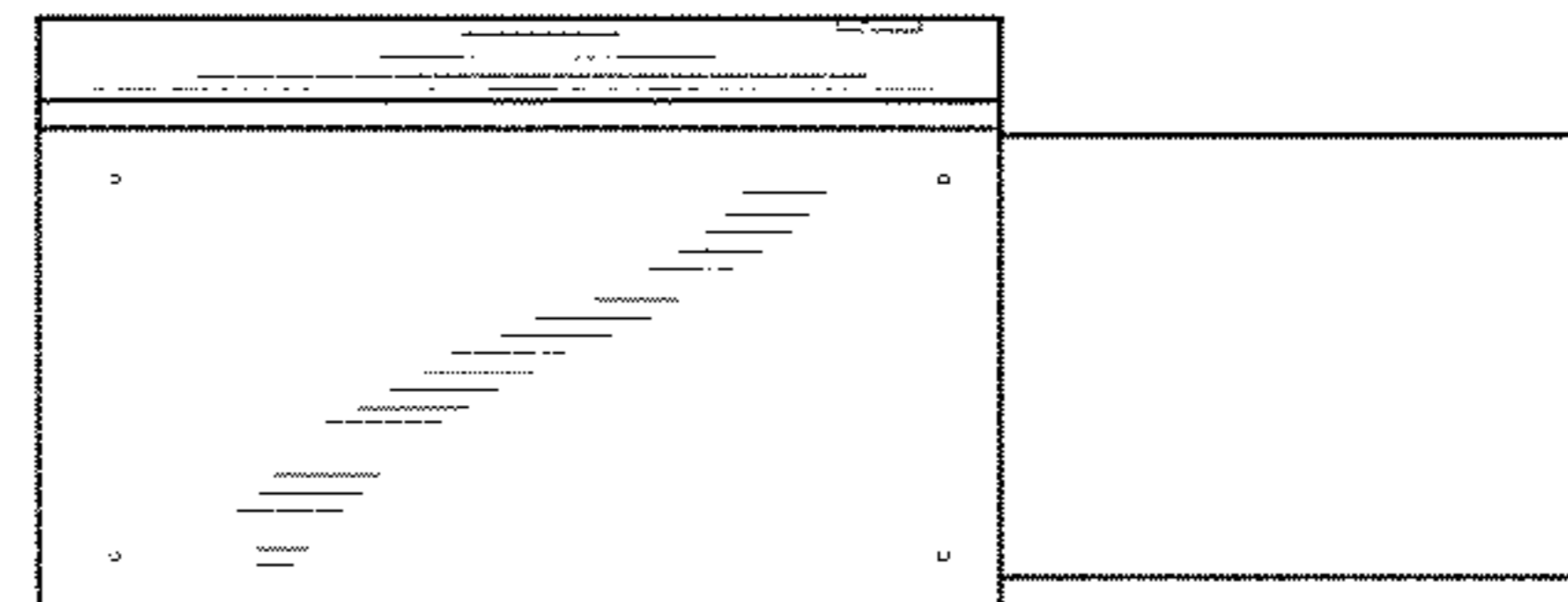

FIG. 34

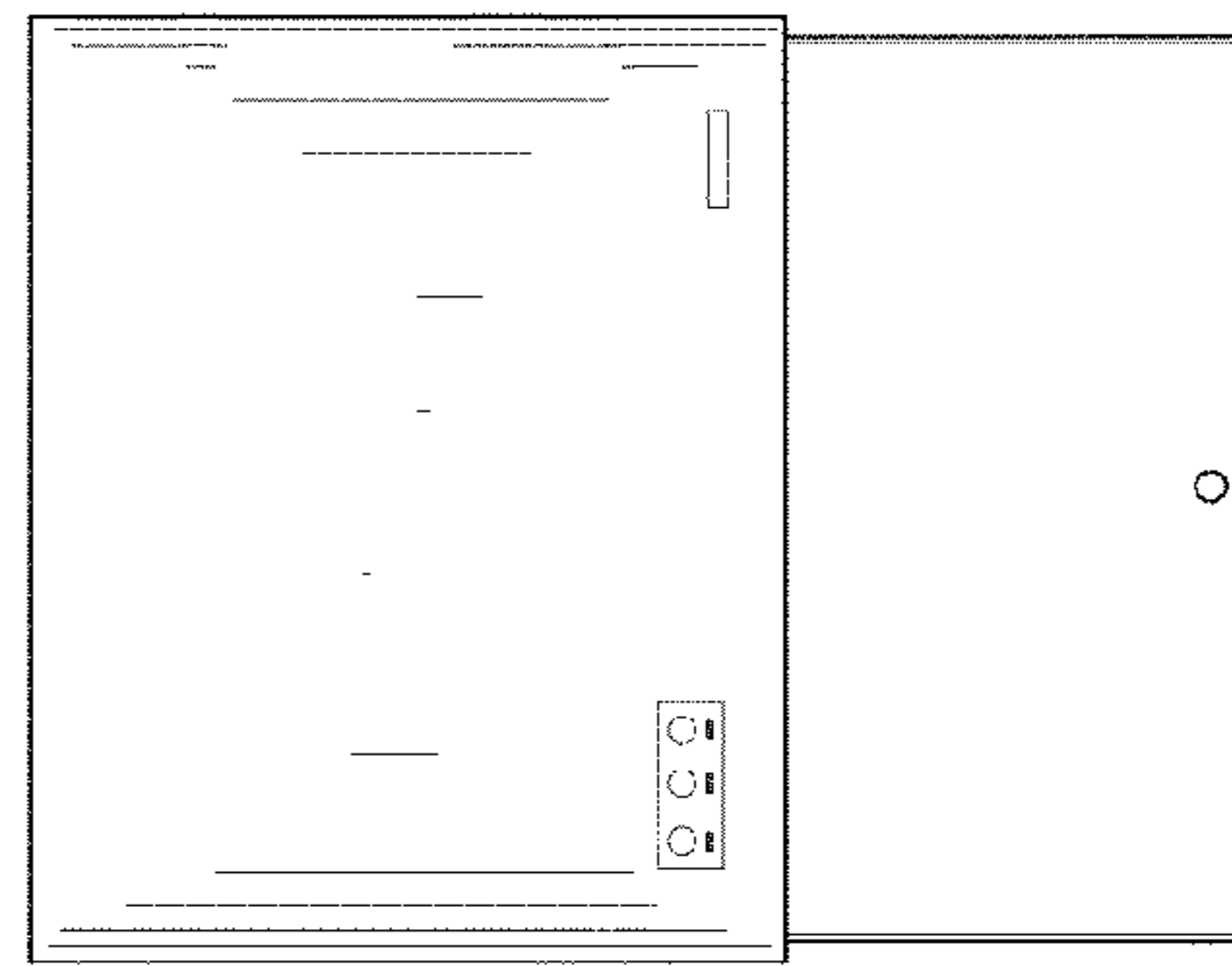

FIG. 35

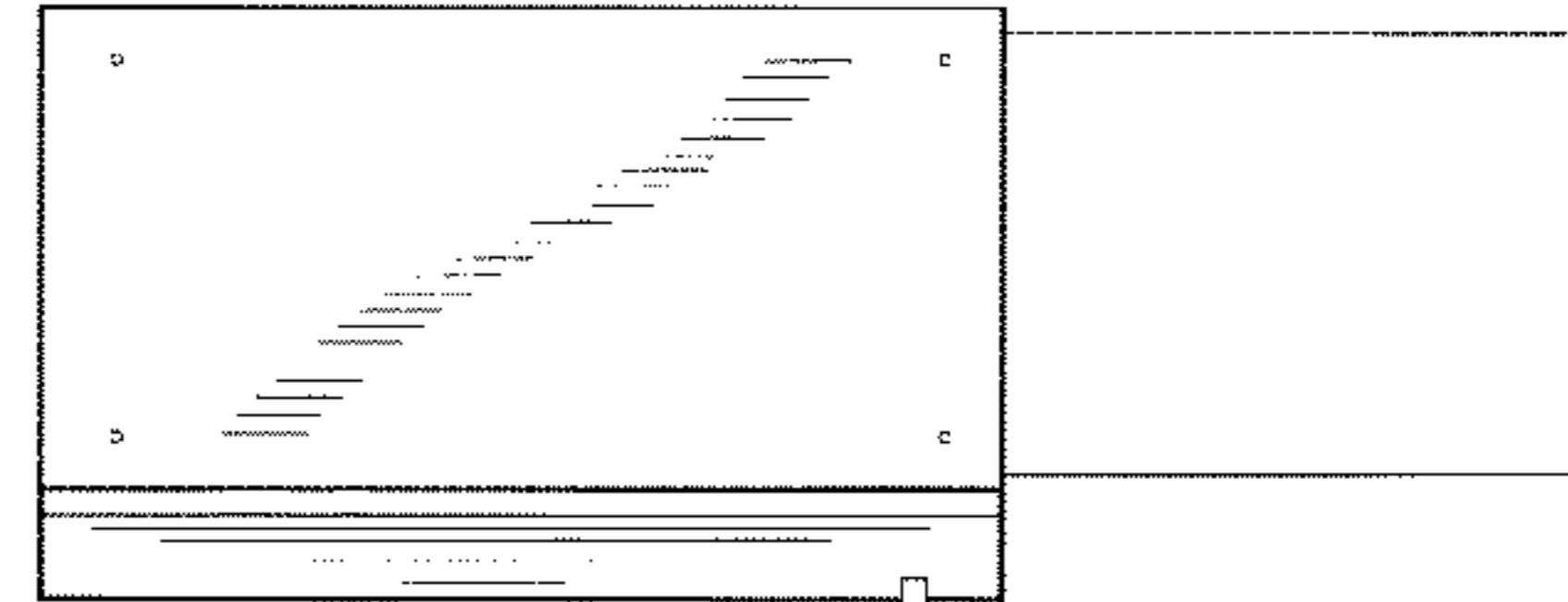

FIG. 36