



US00D679090S

(12) **United States Design Patent**
Du

(10) **Patent No.:** **US D679,090 S**
(45) **Date of Patent:** **** Apr. 2, 2013**

(54) **LUGGAGE WITH SHOE COMPARTMENTS**

DESCRIPTION

(76) Inventor: **Tiffany Du**, Garden Grove, CA (US)

(**) Term: **14 Years**

(21) Appl. No.: **29/416,266**

(22) Filed: **Mar. 20, 2012**

(51) **LOC (9) Cl.** **03-01**

(52) **U.S. Cl.** **D3/279; D3/285; D3/289**

(58) **Field of Classification Search** **D3/273,**
D3/276, 278–279, 283–285, 289, 301; 190/18 A,
190/100–127; 206/278, 286–287.1
See application file for complete search history.

(56) **References Cited**

U.S. PATENT DOCUMENTS

6,000,509	A *	12/1999	Chisholm	190/109
D491,361	S *	6/2004	Bernbaum et al.	D3/279
7,779,976	B2 *	8/2010	Mangano	190/110
D640,868	S *	7/2011	Jongchul	D3/279
D643,624	S *	8/2011	Hong	D3/279
D666,816	S *	9/2012	Weber	D3/279

* cited by examiner

Primary Examiner — Jennifer Rivard

(74) *Attorney, Agent, or Firm* — Richard D. Clarke

(57) **CLAIM**

I claim the ornamental design for luggage with shoe compartments, as shown and described.

FIG. 1 is a perspective view of the luggage with shoe compartments;

FIG. 2 is a top plan view of the luggage with shoe compartments;

FIG. 3 is a bottom plan view of the luggage with shoe compartments;

FIG. 4 is a side elevation view of the luggage with shoe compartments;

FIG. 5 is a side elevation view of the opposite side of the luggage with shoe compartments;

FIG. 6 is a rear view of the luggage with shoe compartments showing the handle in an extended position;

FIG. 7 is a front view of the luggage with shoe compartments showing the handle in an extended position;

FIG. 8 is a front view of the luggage with shoe compartments, showing the shoe compartments open;

FIG. 9 is a perspective view of the luggage with shoe compartments showing the interior of the luggage; and,

FIG. 10 is a perspective view of the luggage with shoe compartments, showing the upper portion of the luggage in an expanded position and with the shoe compartments open.

The broken line showing of environment in FIG. 8 and FIG. 10 is included for the purpose of illustration only and forms no part of the claimed design.

1 Claim, 8 Drawing Sheets

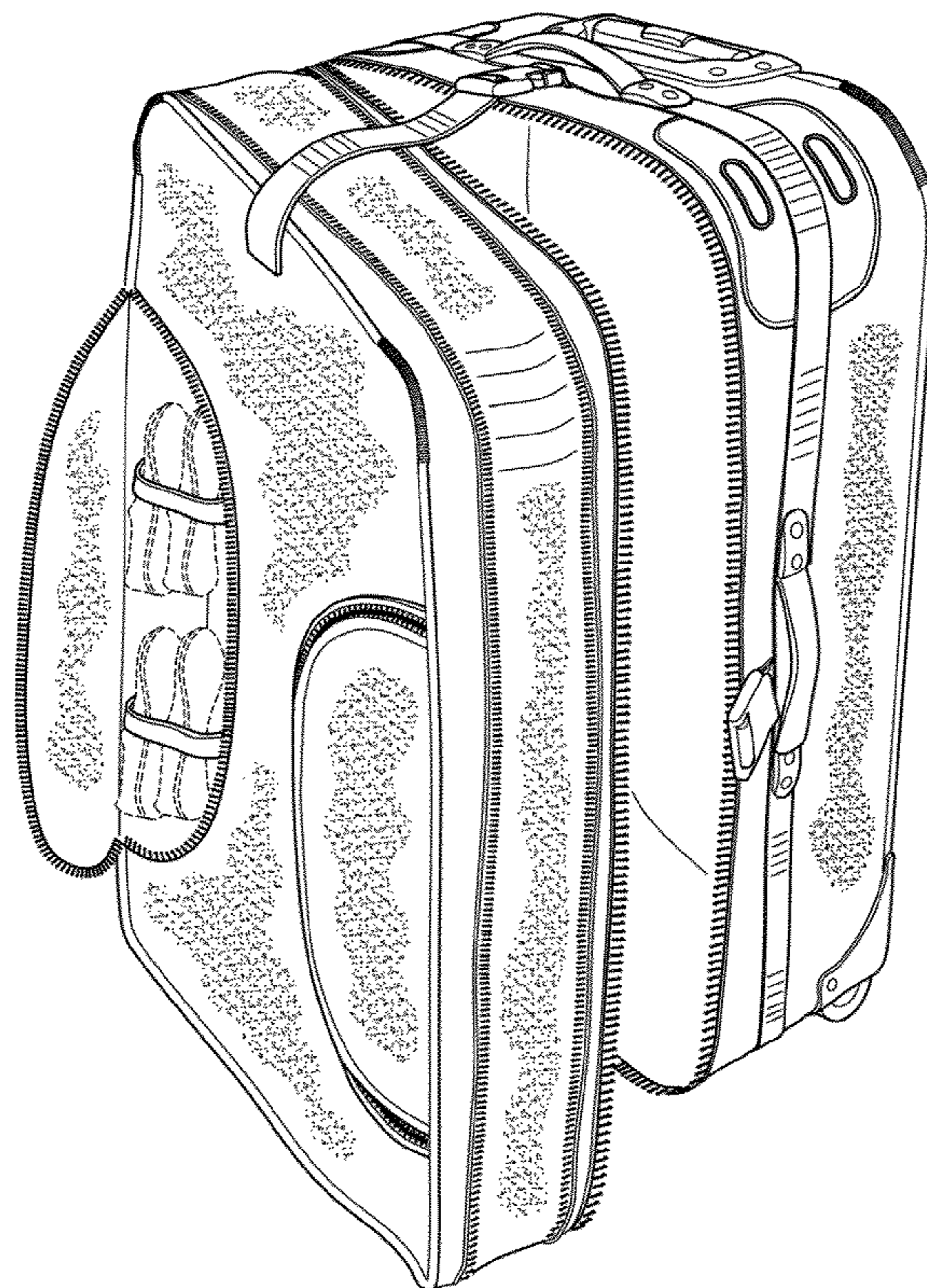



FIG. 1

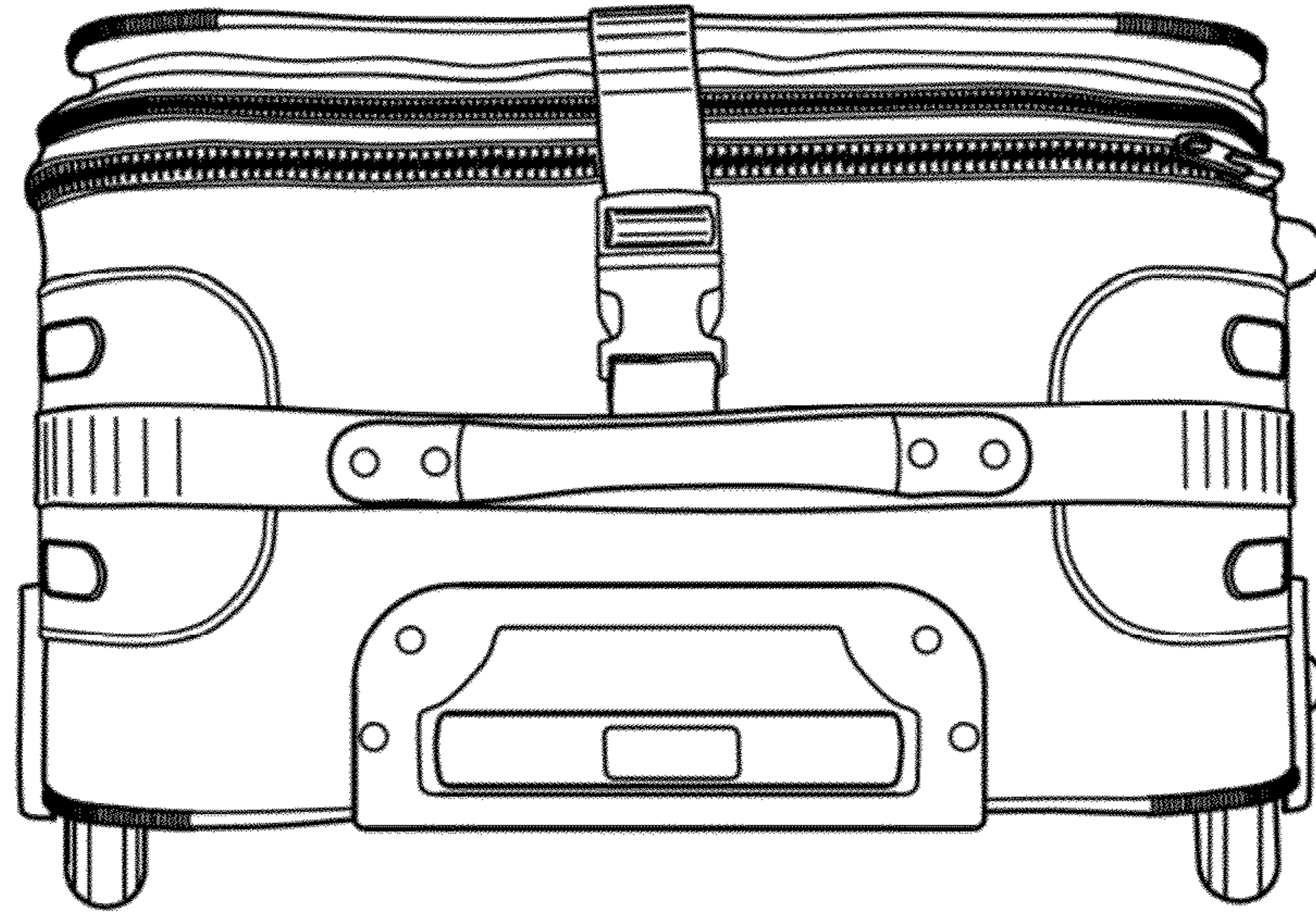

FIG. 2

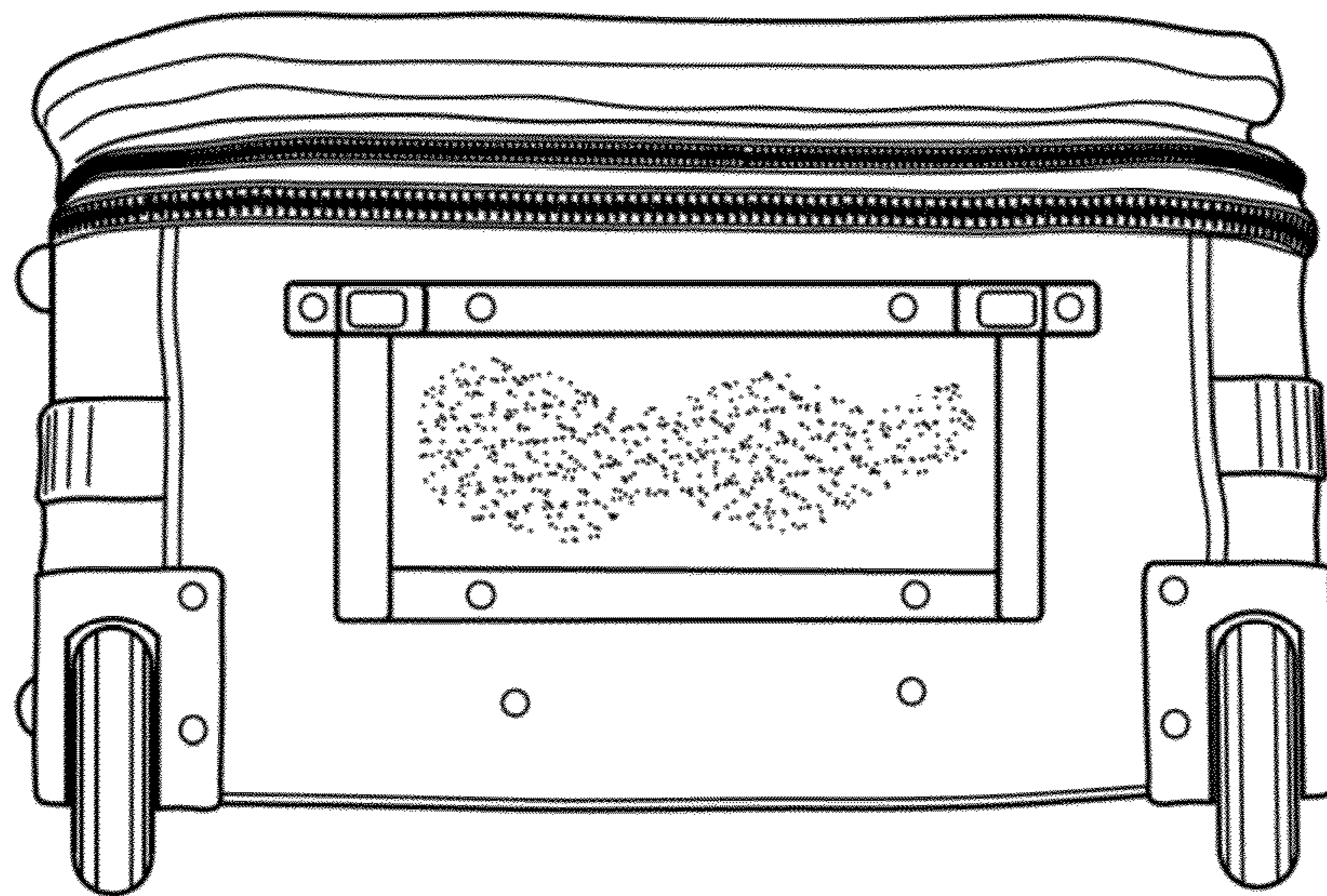

FIG. 3

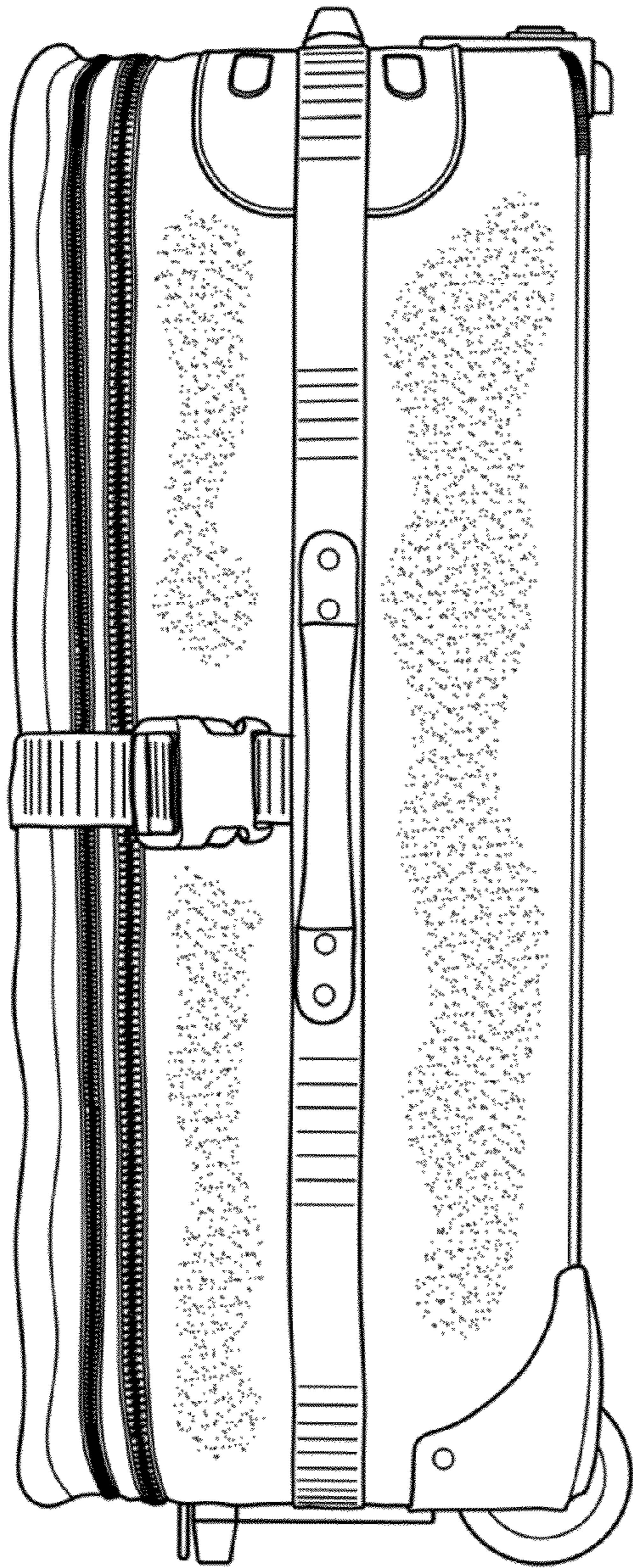

FIG. 4

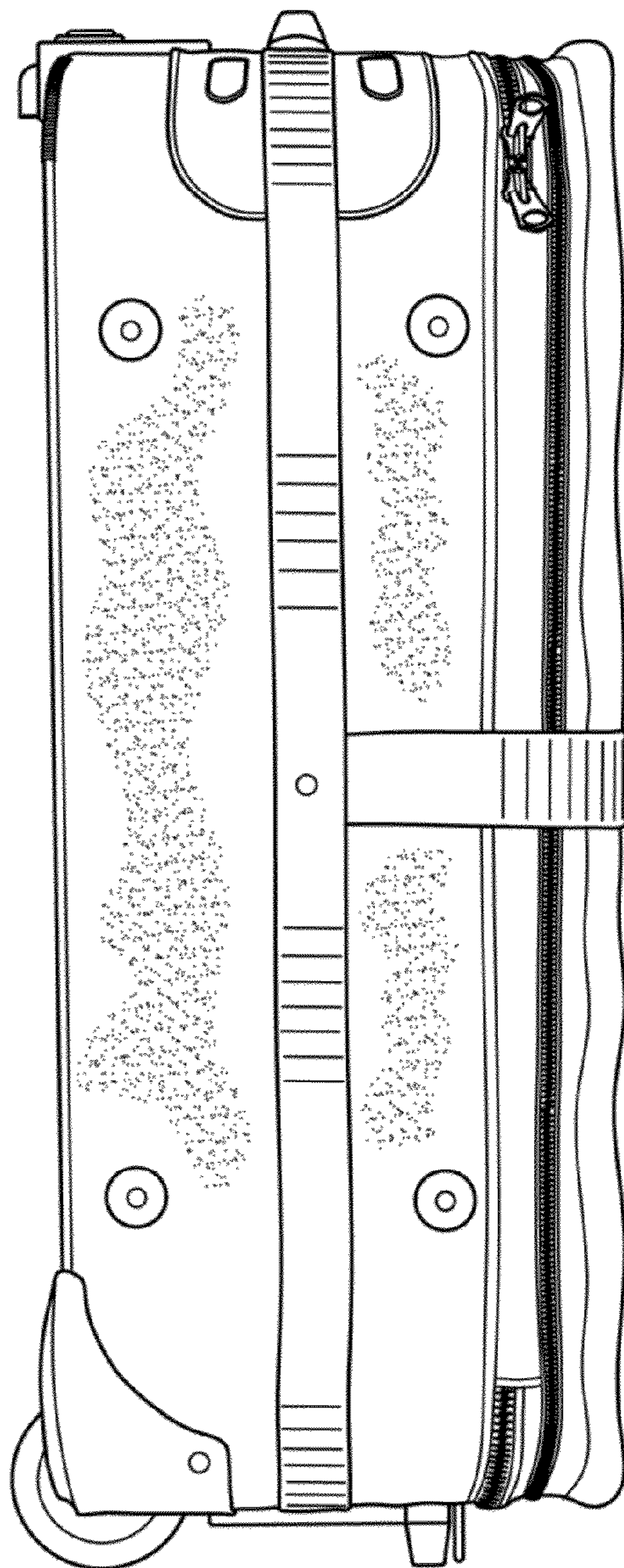

FIG. 5

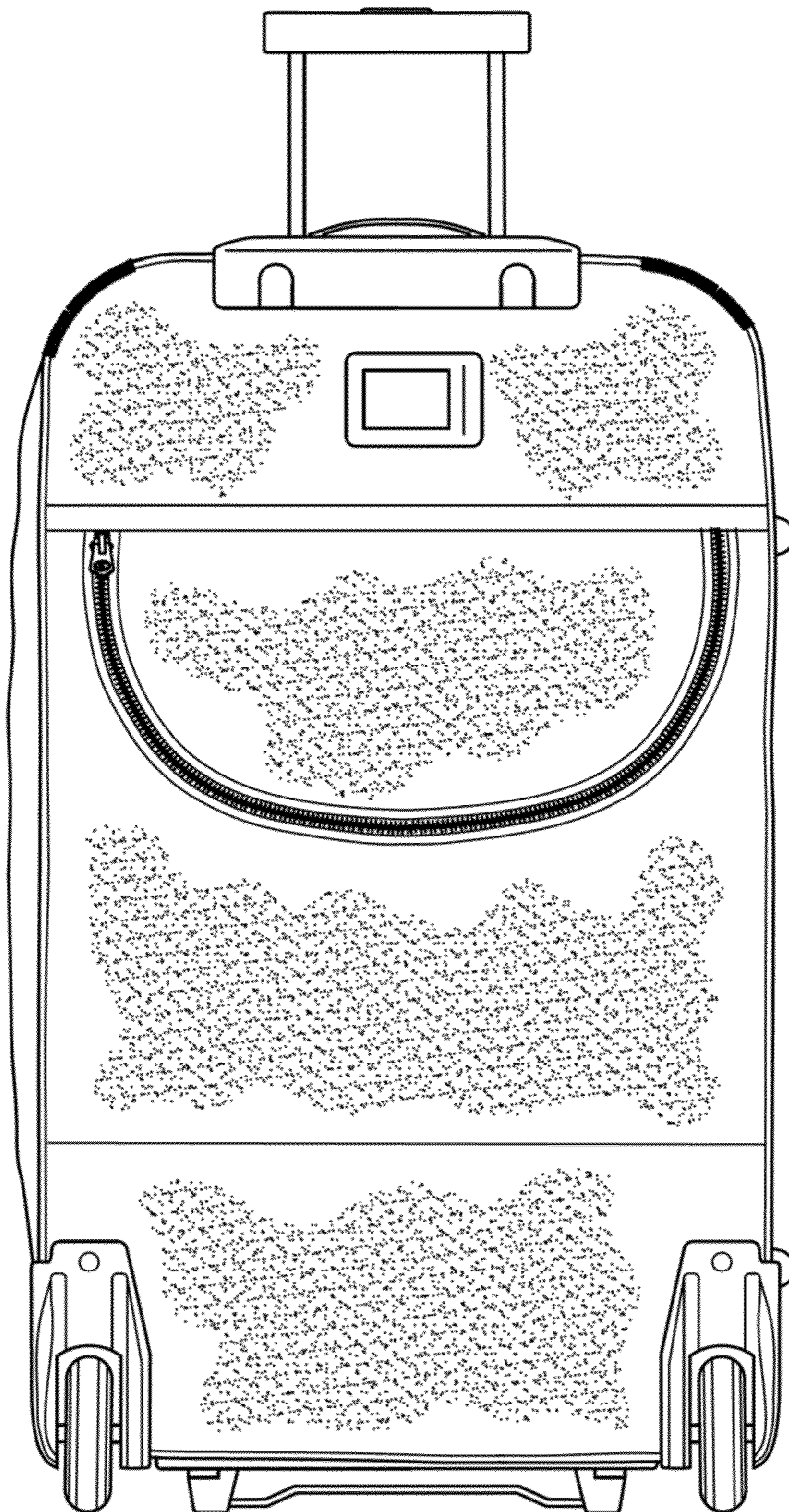

FIG. 6

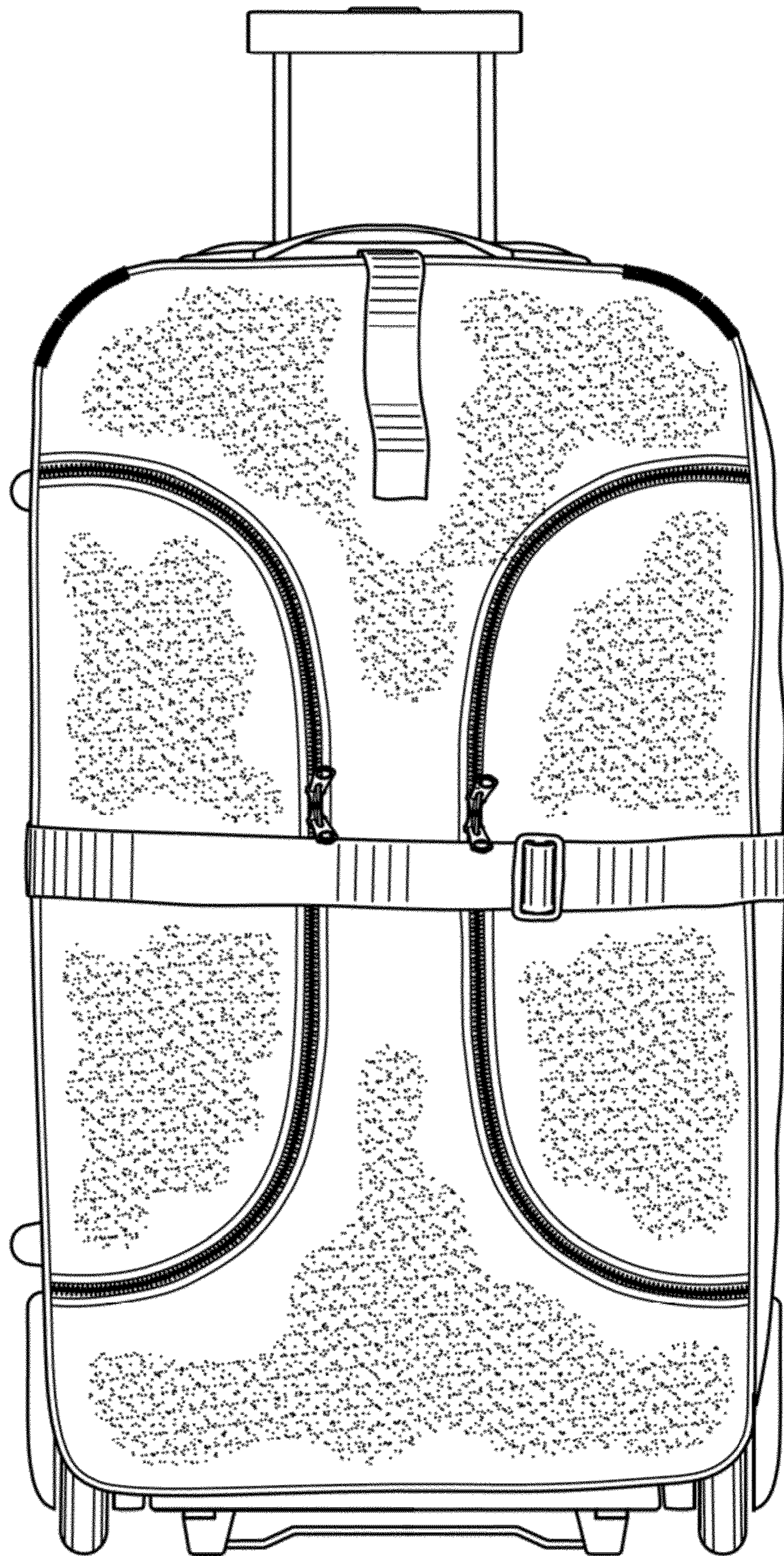

FIG. 7

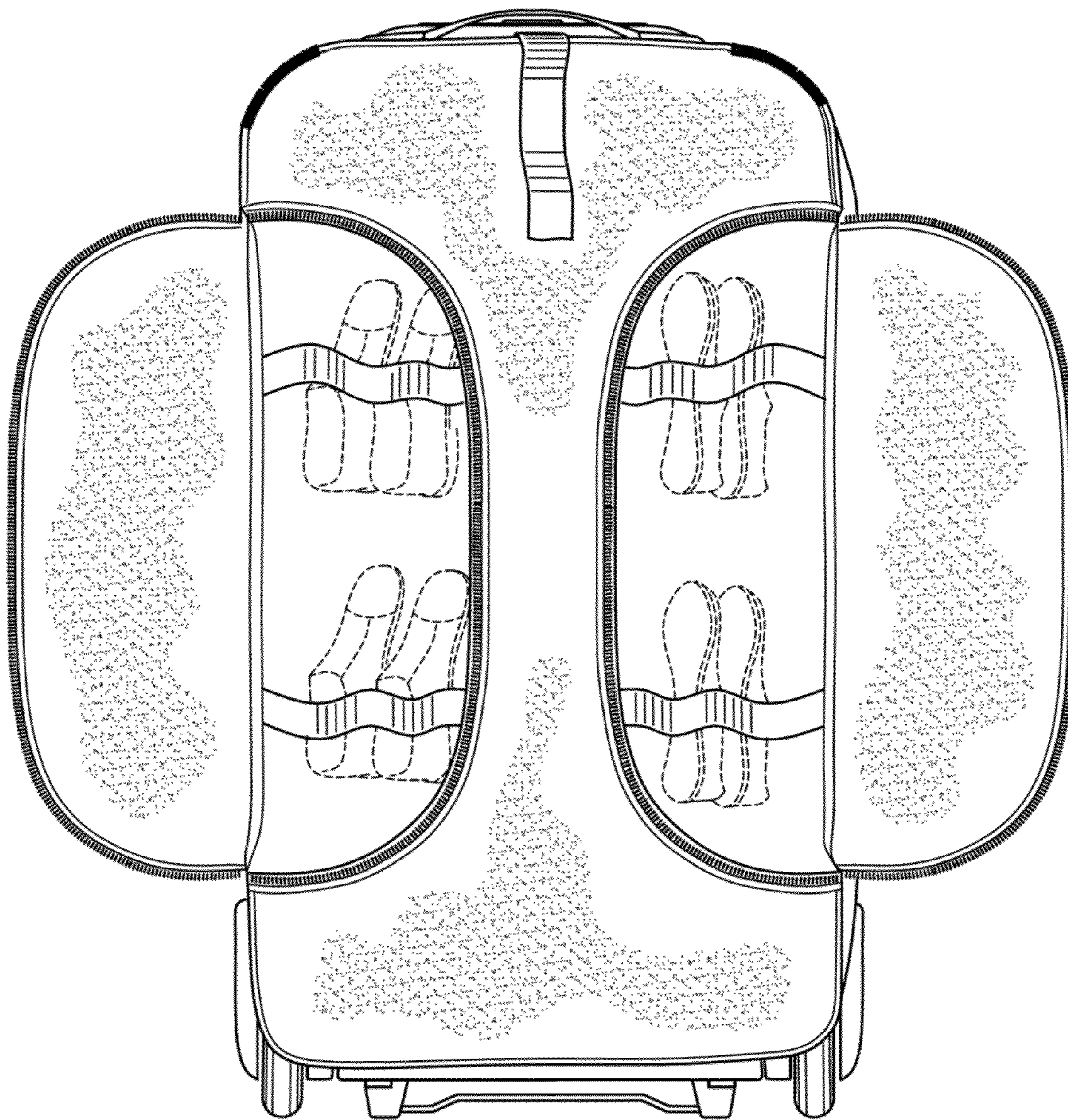

FIG. 8

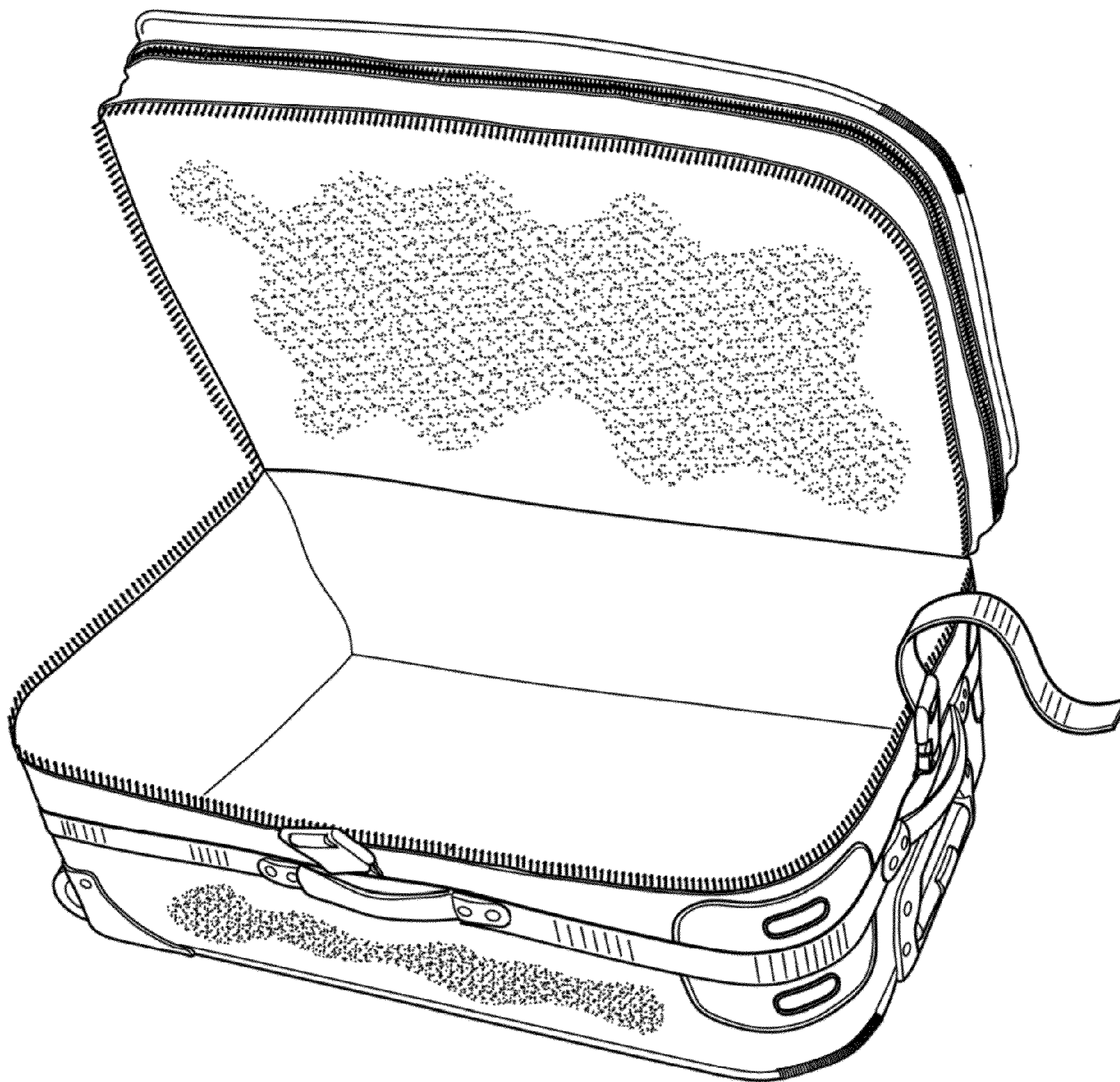

FIG. 9

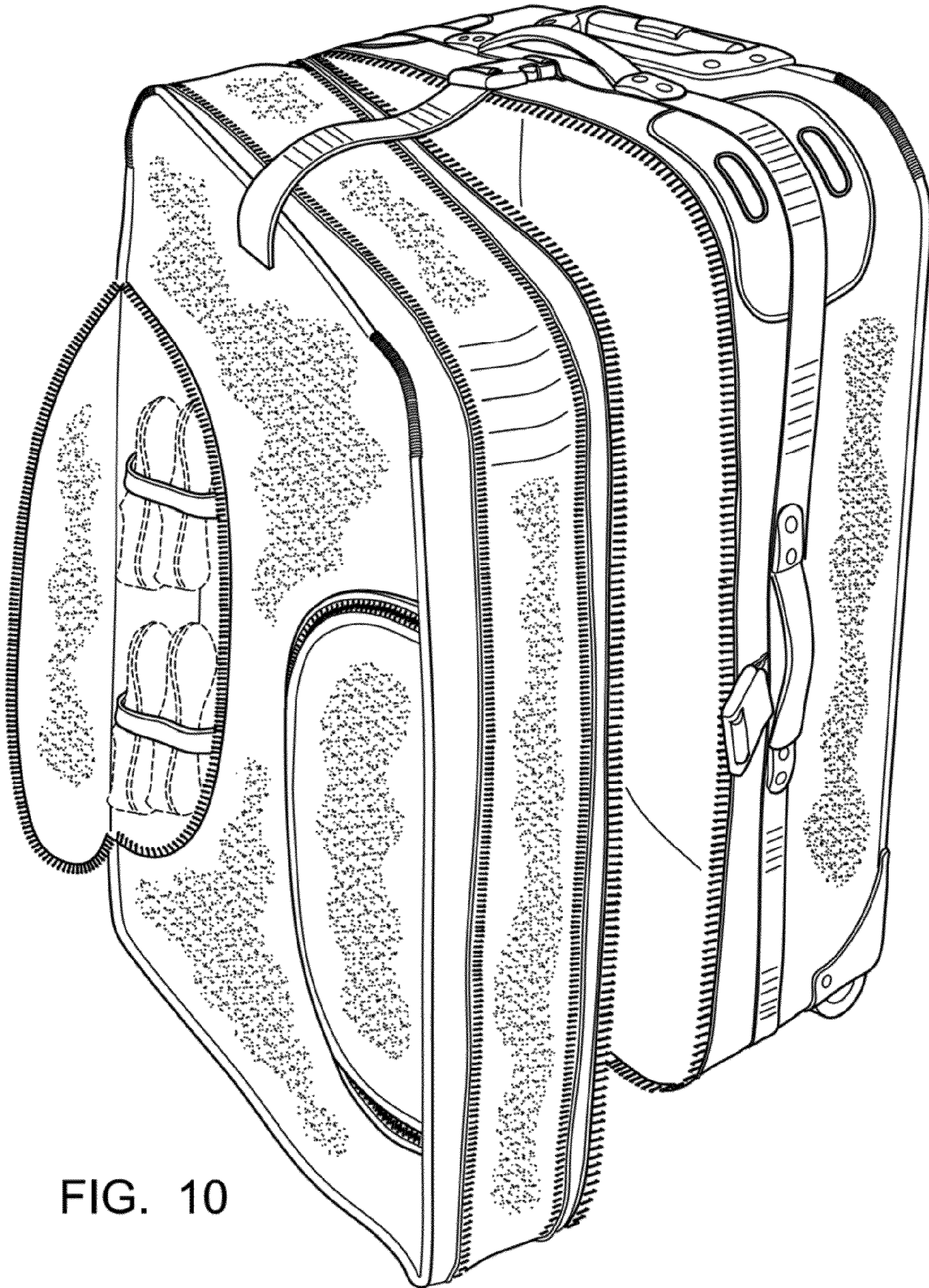

FIG. 10