



US00D678965S

(12) **United States Design Patent**
Oldknow et al.

(10) **Patent No.:** **US D678,965 S**

(45) **Date of Patent:** **** *Mar. 26, 2013**

(54) **GOLF CLUB HEAD**

(75) Inventors: **Andrew G. V. Oldknow**, Beaverton, OR (US); **John T. Stites**, Weatherford, TX (US); **Sherry Lynn Jones**, Pataskala, OH (US); **James Huang Lua**, Columbus, OH (US)

(73) Assignee: **NIKE, Inc.**, Beaverton, OR (US)

(*) Notice: This patent is subject to a terminal disclaimer.

(**) Term: **14 Years**

(21) Appl. No.: **29/429,912**

(22) Filed: **Aug. 17, 2012**

(51) **LOC (9) Cl.** **21-02**

(52) **U.S. Cl.** **D21/752**

(58) **Field of Classification Search** D21/733, D21/752, 759; 473/324–331, 343–346
See application file for complete search history.

(56) **References Cited**

U.S. PATENT DOCUMENTS

1,541,126	A *	6/1925	Dunn	473/328
D354,103	S *	1/1995	Allen	D21/752
5,464,217	A *	11/1995	Shenoha et al.	473/328
5,547,188	A	8/1996	Dumontier et al.	
D375,535	S *	11/1996	Gorman	D21/752
D375,987	S *	11/1996	Lin	D21/752
D392,007	S *	3/1998	Fox	D21/752
D397,387	S *	8/1998	Allen	D21/733
D465,251	S *	11/2002	Wood et al.	D21/752
D490,870	S	6/2004	Burrows	
D507,030	S *	7/2005	Burrows	D21/752
D524,394	S	7/2006	Madore et al.	
D524,396	S	7/2006	Madore et al.	
D529,111	S	9/2006	Cleveland et al.	
D544,058	S	6/2007	Oldknow	
D544,557	S	6/2007	Oldknow	
D564,607	S	3/2008	Oldknow et al.	
D566,214	S *	4/2008	Evans et al.	D21/752
D569,941	S	5/2008	Evans et al.	
D589,576	S *	3/2009	Kadoya	D21/759
D591,810	S	5/2009	Murphy et al.	

7,591,737	B2	9/2009	Gibbs et al.	
D605,714	S	12/2009	Barez et al.	
D618,751	S	6/2010	Breier et al.	
D621,892	S	8/2010	Kohno	
D622,337	S	8/2010	Kohno	
D627,842	S	11/2010	Gray et al.	
7,837,577	B2	11/2010	Evans	
D630,279	S	1/2011	Kuan	
D637,670	S	5/2011	Foster et al.	
D637,671	S	5/2011	Kim et al.	
D641,818	S	7/2011	Foster et al.	
D643,897	S *	8/2011	Lee et al.	D21/752
8,016,694	B2	9/2011	Llewellyn et al.	
D646,344	S	10/2011	Glod	
D647,583	S	10/2011	Foster et al.	

(Continued)

OTHER PUBLICATIONS

Edwin Watts Golf Catalog, Holiday 2004; pp. 18 and 35, published Holiday 2004.

(Continued)

Primary Examiner — Mitchell Siegel

(74) *Attorney, Agent, or Firm* — Banner & Witcoff, Ltd.

(57) **CLAIM**

The ornamental design for a golf club head, as shown and described.

DESCRIPTION

FIG. 1 is a first perspective view of a golf club head showing my/our new design;
FIG. 2 is a second perspective view thereof;
FIG. 3 is a bottom view thereof;
FIG. 4 is a heel end view thereof;
FIG. 5 is a toe end view thereof;
FIG. 6 is a front view thereof;
FIG. 7 is a rear view thereof; and,
FIG. 8 is a top view thereof.
The broken lines immediately adjacent to the shaded areas represent unclaimed boundaries of the design. The broken lines showing the remainder of the golf club head in are for environmental purposes only and form no part of the claimed design.

1 Claim, 6 Drawing Sheets

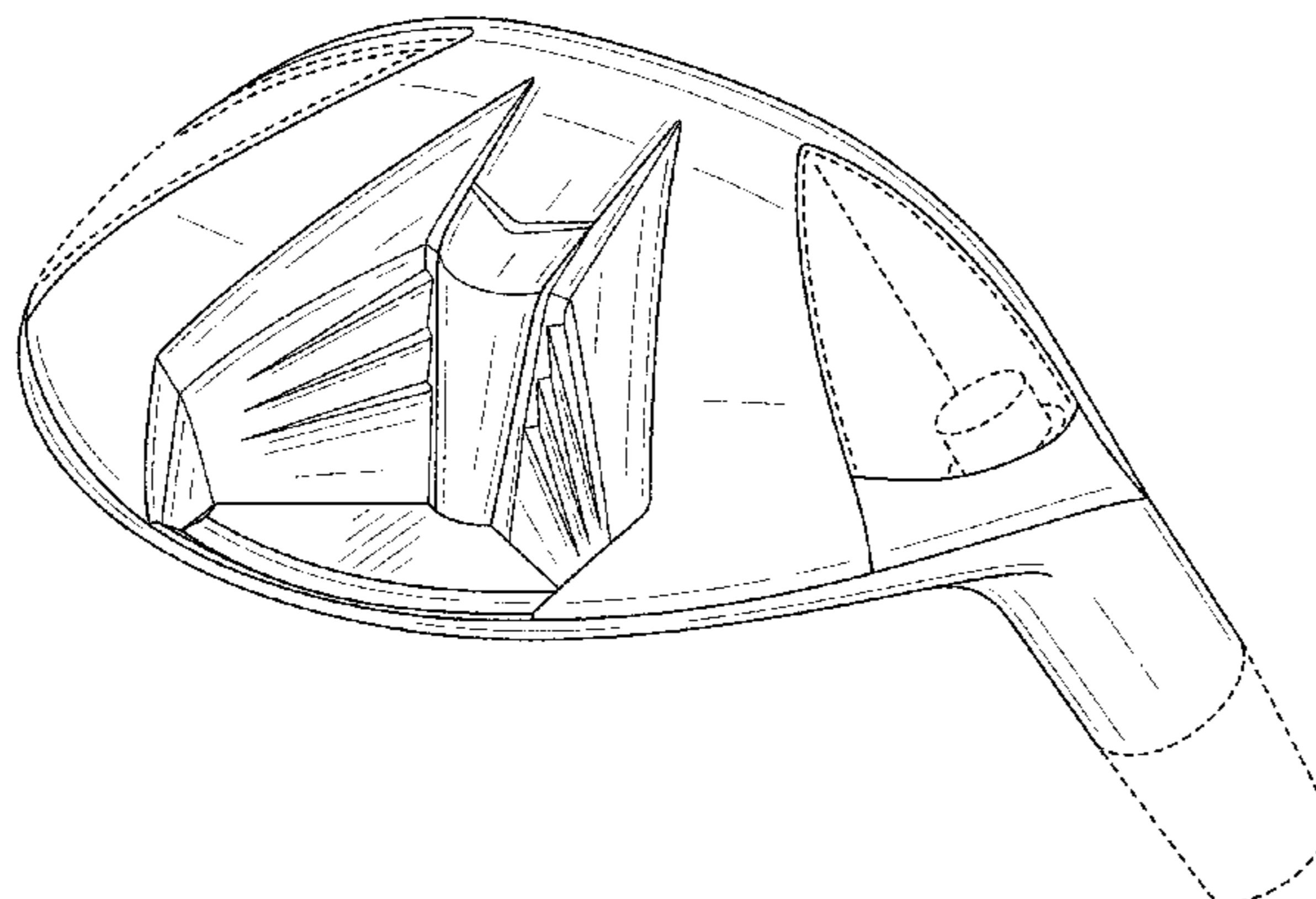

U.S. PATENT DOCUMENTS

D652,880 S	1/2012	Foster et al.
D654,130 S	2/2012	Glod
D656,210 S	3/2012	Foster et al.
2010/0190574 A1	7/2010	Foster et al.
2011/0009210 A1	1/2011	Stites et al.

OTHER PUBLICATIONS

Golfsmith Golf Catalog, Spring 2010; pp. 4 and 7, published Spring 2010.

Edwin Watts Golf Catalog, Mar. 2011; pp. 2 and 4, published Mar. 2011.

Edwin Watts Golf Catalog, Apr. 2011; pp. 12 and 22, published Apr. 2011.

Bridgestone J40 430 Driver, announcement date unknown, but prior to filing [online], [site visited Aug. 2012]. Available from Internet, <URL: <http://www.edwinwattsgolf.com>>.

Bridgestone J40 Hybrid announcement date unknown, but prior to filing [online], [site visited Aug. 2012]. Available from Internet, <URL: <http://www.edwinwattsgolf.com>>.

TaylorMade R11S Driver, announcement date unknown, but prior to filing [online], [site visited Aug. 2012]. Available from Internet, <URL: <http://www.edwinwattsgolf.com>>.

Titleist 910H Wyvem Hybrid, announcement date unknown, but prior to filing [online], [site visited Aug. 2012]. Available from Internet, <URL: <http://www.edwinwattsgolf.com>>.

TourEdge Backdraft, announcement date unknown, but prior to filing [online], [site visited Aug. 2012]. Available from Internet, <URL: <http://www.edwinwattsgolf.com>>.

TourEdge Exotics XCG5 Hybrid 65G, announcement date unknown, but prior to filing [online], [site visited Aug. 2012]. Available from Internet, <URL: <http://www.edwinwattsgolf.com>>.

* cited by examiner

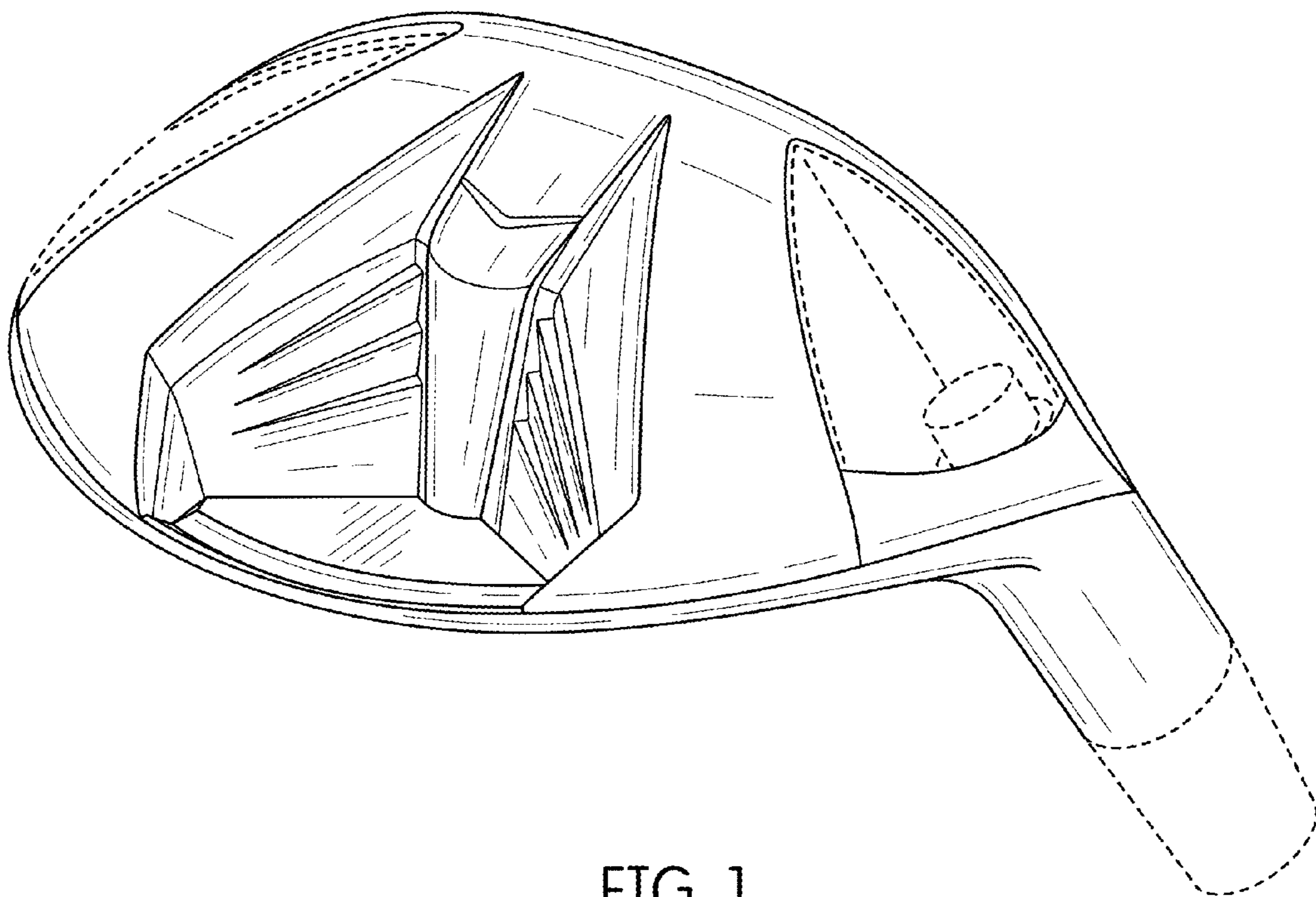

FIG. 1

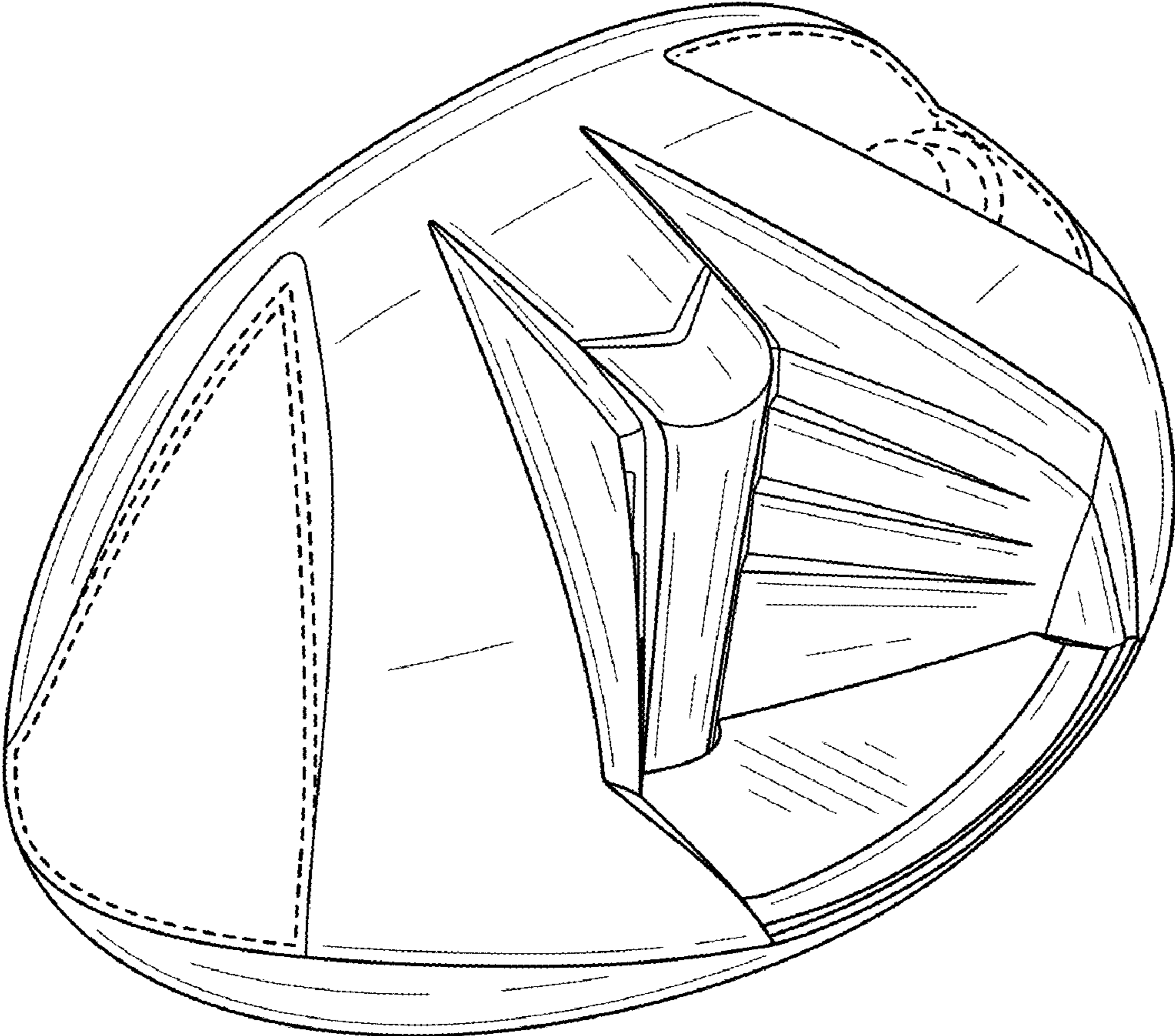

FIG. 2

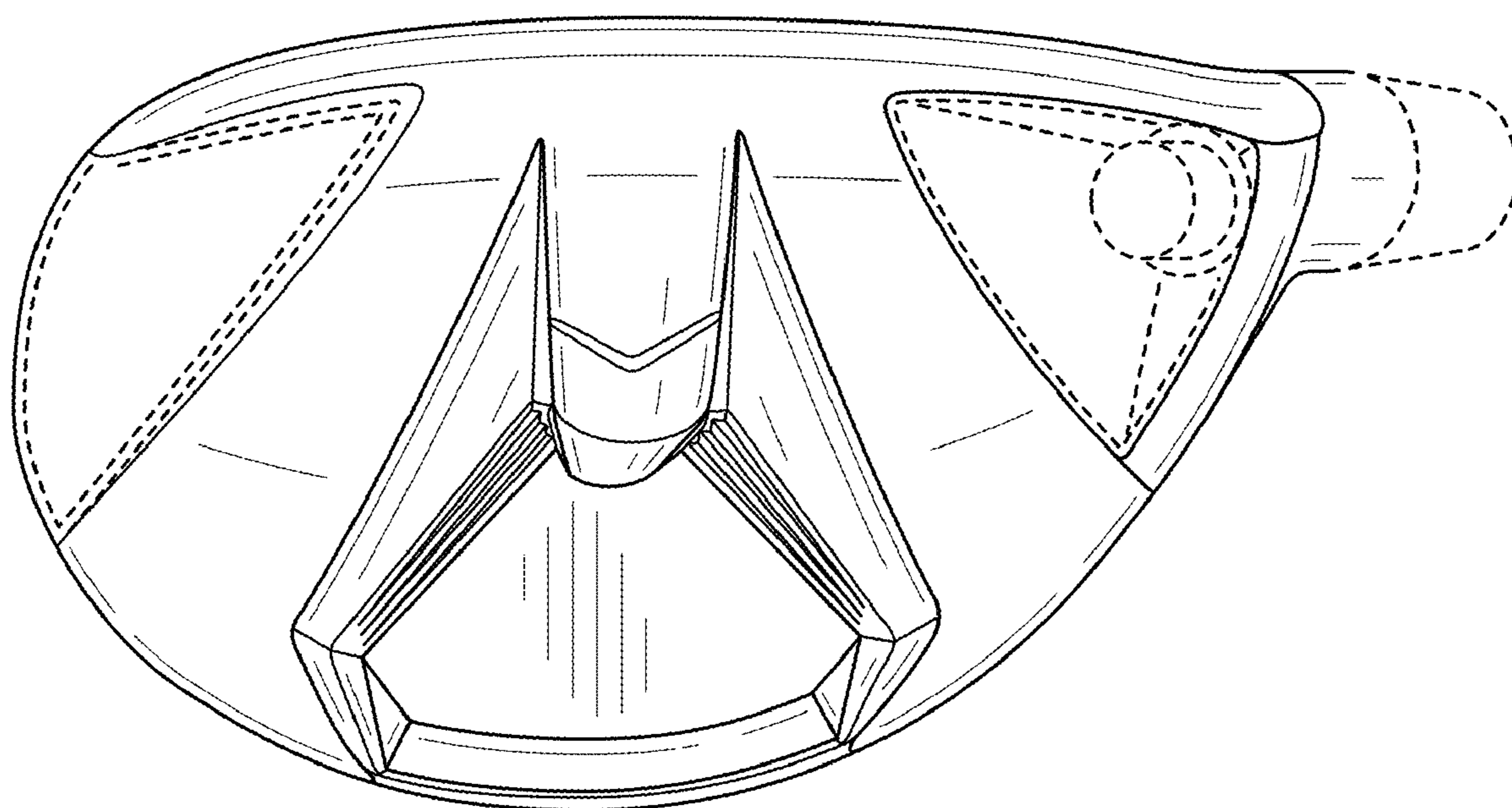

FIG. 3

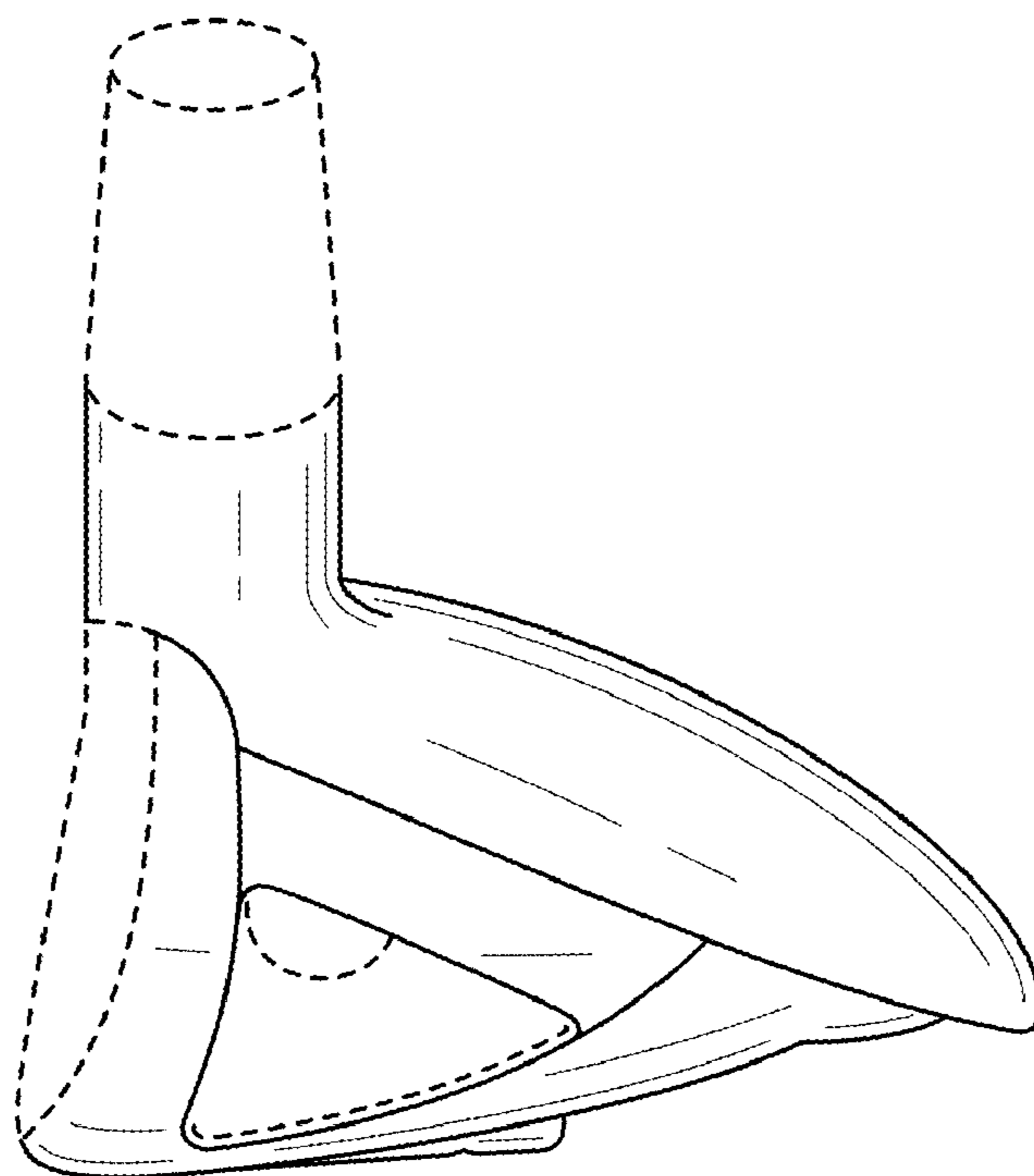

FIG. 4

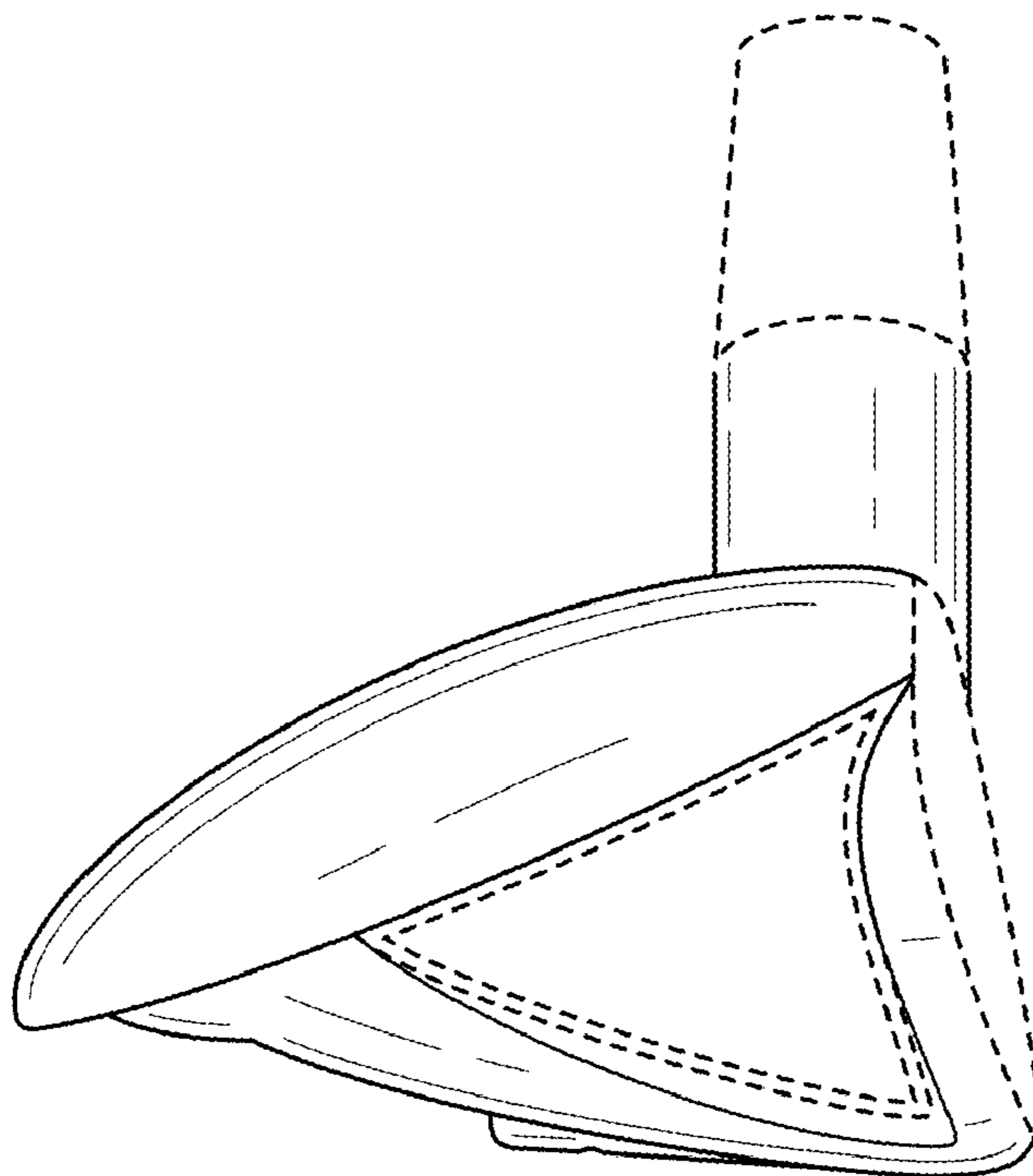

FIG. 5

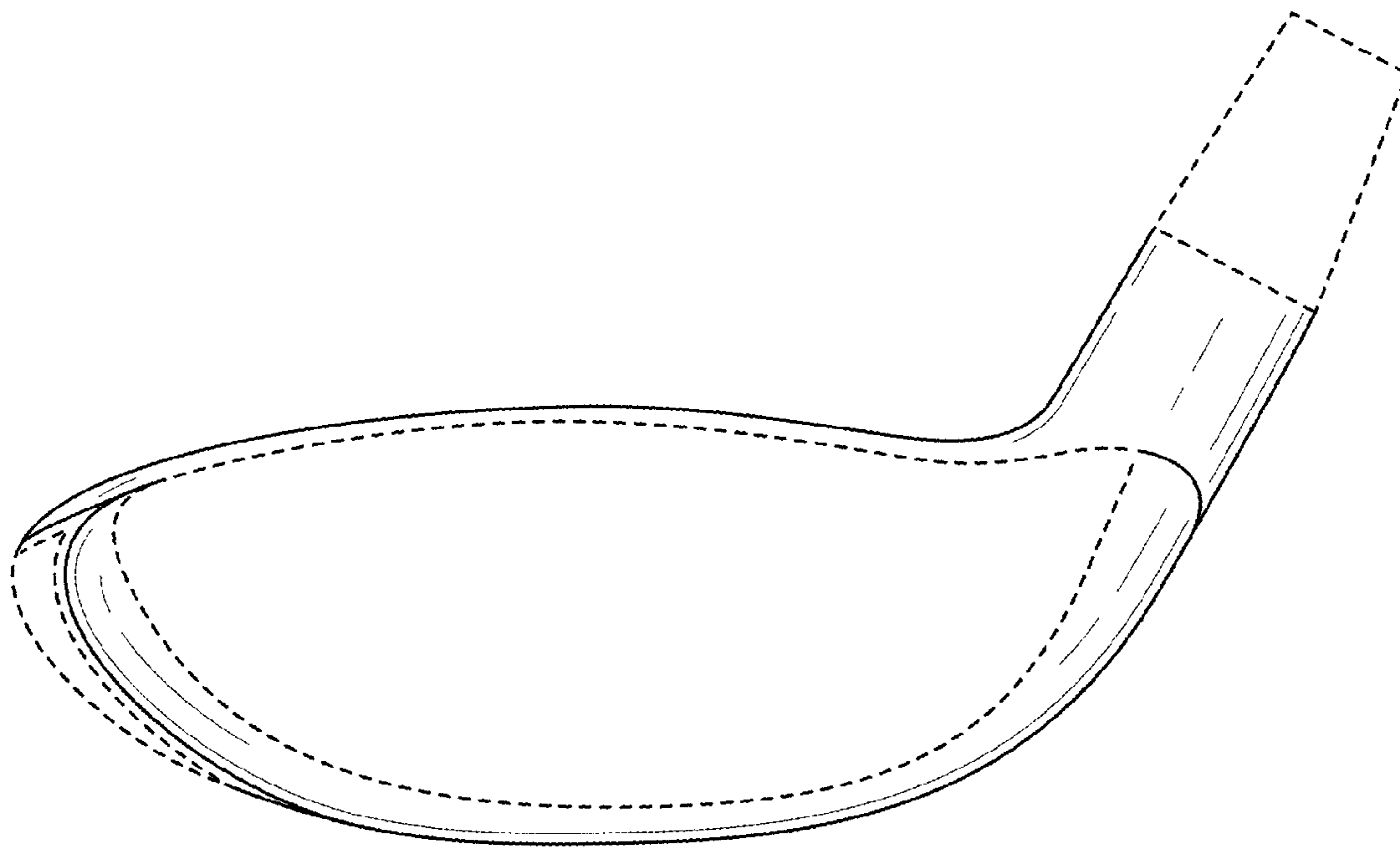

FIG. 6

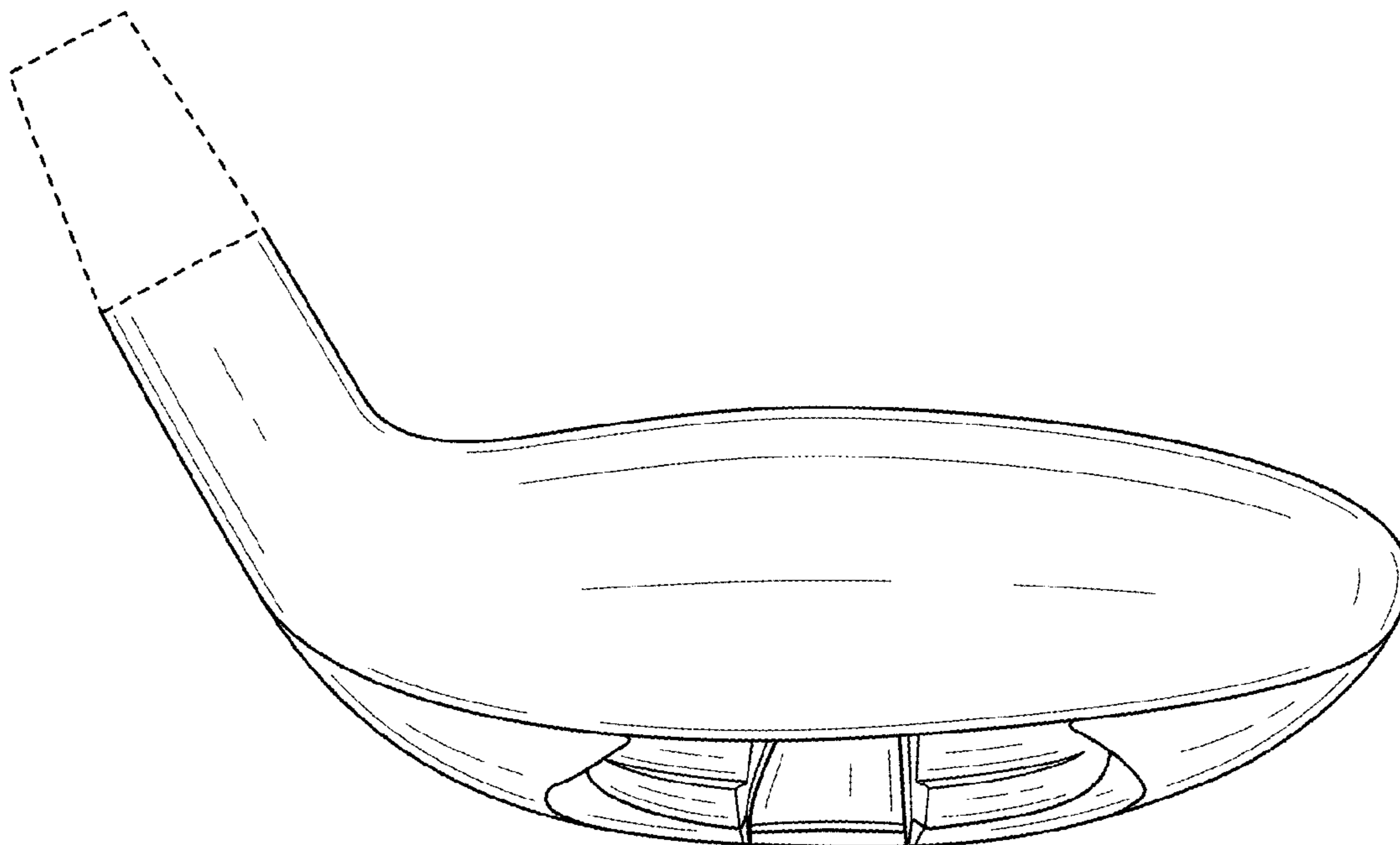

FIG. 7

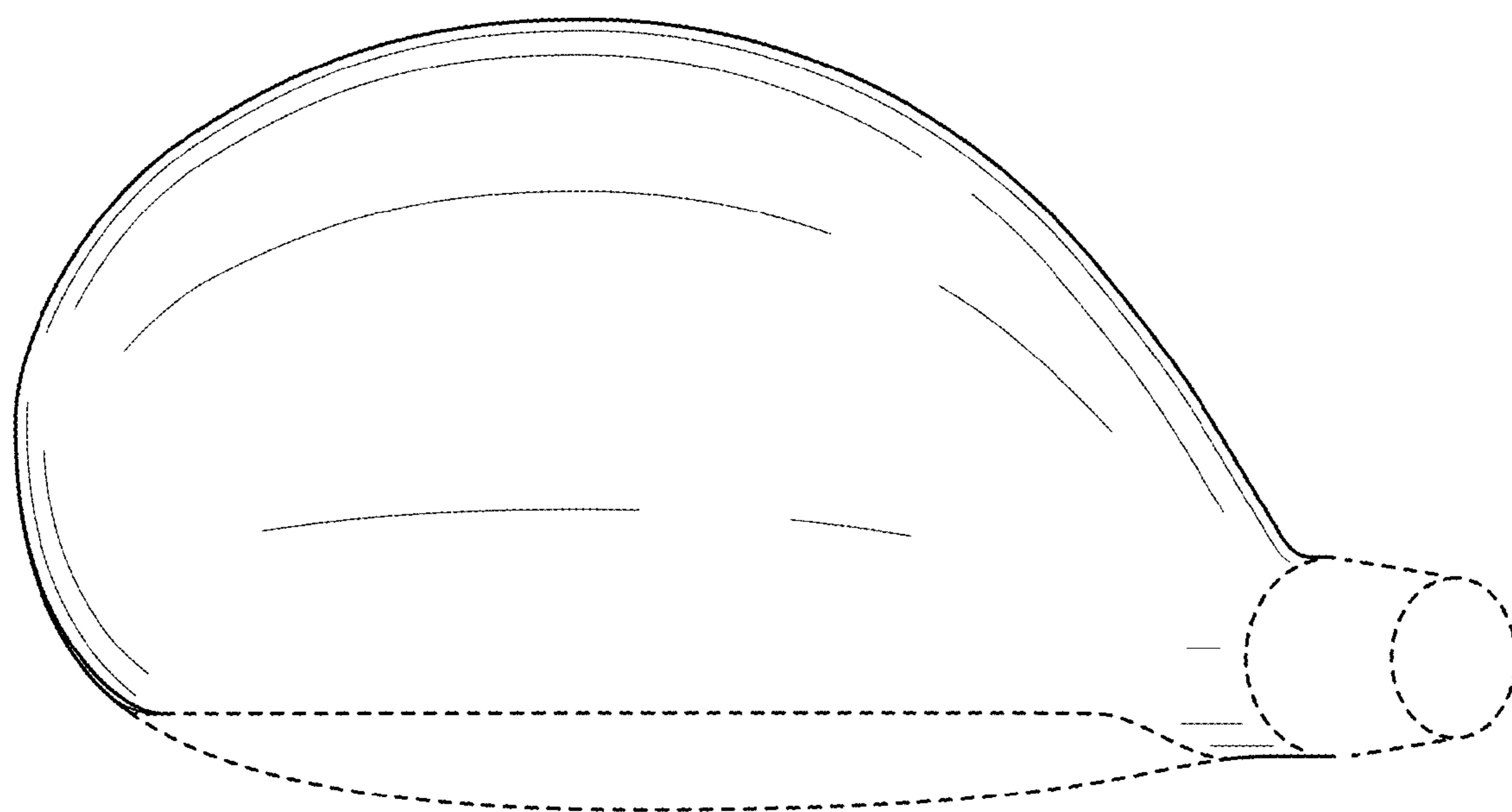

FIG. 8