



US00D678942S

(12) **United States Design Patent**
Yuan

(10) **Patent No.:** **US D678,942 S**
(45) **Date of Patent:** **** Mar. 26, 2013**

- (54) **PEN**
- (75) Inventor: **Fang Yuan**, Ningbo (CN)
- (73) Assignee: **Beifa Group Co., Ltd.**, Ningbo (CN)
- (**) Term: **14 Years**
- (21) Appl. No.: **29/400,015**
- (22) Filed: **Aug. 22, 2011**
- (30) **Foreign Application Priority Data**
Feb. 22, 2011 (CN) 2011 3 0026275
- (51) **LOC (9) Cl.** **19-06**
- (52) **U.S. Cl.** **D19/46**
- (58) **Field of Classification Search** D14/411;
D19/35, 36, 41-51, 54-58; 24/11 F, 11 P,
24/11 R; 401/52, 99-109, 192, 195, 196
See application file for complete search history.

(56) **References Cited**

U.S. PATENT DOCUMENTS

D179,615 S *	1/1957	Spatz	D28/4
D258,217 S	2/1981	Sakaoka	
D263,318 S	3/1982	Oka	
D270,547 S	9/1983	Bajusz	
D275,297 S	8/1984	Ohyabu	
D287,373 S *	12/1986	Regnault	D19/43
D303,990 S	10/1989	Petterson	
D327,621 S *	7/1992	Heller	D8/82
D328,919 S *	8/1992	Bulgari	D19/51
D329,460 S *	9/1992	Rousseau	D19/46
D445,828 S *	7/2001	Beng	D19/45
D454,584 S *	3/2002	Mershon	D19/36
D478,350 S *	8/2003	Furlong	D19/43

D495,742 S	9/2004	Collin	
D501,880 S *	2/2005	Collin	D19/43
D503,740 S *	4/2005	Carre	D19/50
D545,366 S	6/2007	Ternovits	
D555,727 S *	11/2007	Bruzzi	D19/48
D556,825 S *	12/2007	Bruzzi	D19/51
D561,832 S *	2/2008	Bhavnani	D19/51
D565,653 S *	4/2008	Freed et al.	D19/36
D568,932 S *	5/2008	Qiu et al.	D19/43
D568,939 S *	5/2008	Bhavnani	D19/57
D580,975 S	11/2008	Yu	
D593,154 S *	5/2009	Bruzzi	D19/46
D622,768 S *	8/2010	Tissier	D19/46
D628,633 S *	12/2010	Zhang	D19/46
D652,079 S *	1/2012	Tissier	D19/46
D657,820 S *	4/2012	Bruzzi	D19/42

* cited by examiner

Primary Examiner — Elizabeth Albert

(74) *Attorney, Agent, or Firm* — Christensen O'Connor Johnson Kindness PLLC

(57) **CLAIM**

The ornamental design for a pen, as shown and described.

DESCRIPTION

FIG. 1 is a lower front left perspective view of a pen showing my new design;
 FIG. 2 is a front elevation view thereof;
 FIG. 3 is a rear elevation view thereof;
 FIG. 4 is a left side elevation view thereof, with the right side elevation view being a mirror image of the left side elevation view;
 FIG. 5 is an enlarged top plan view thereof; and,
 FIG. 6 is an enlarged bottom plan view thereof.

1 Claim, 4 Drawing Sheets

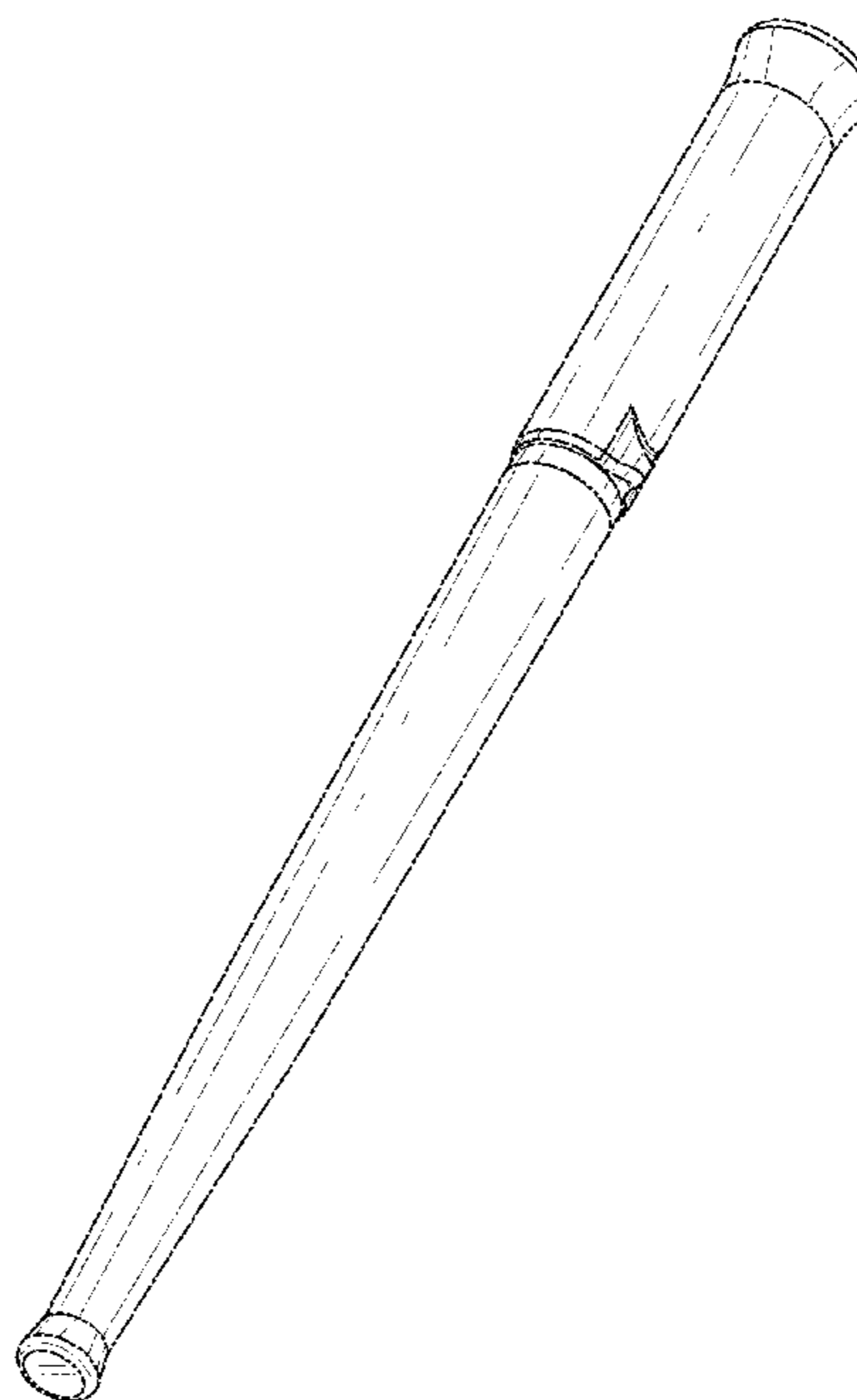

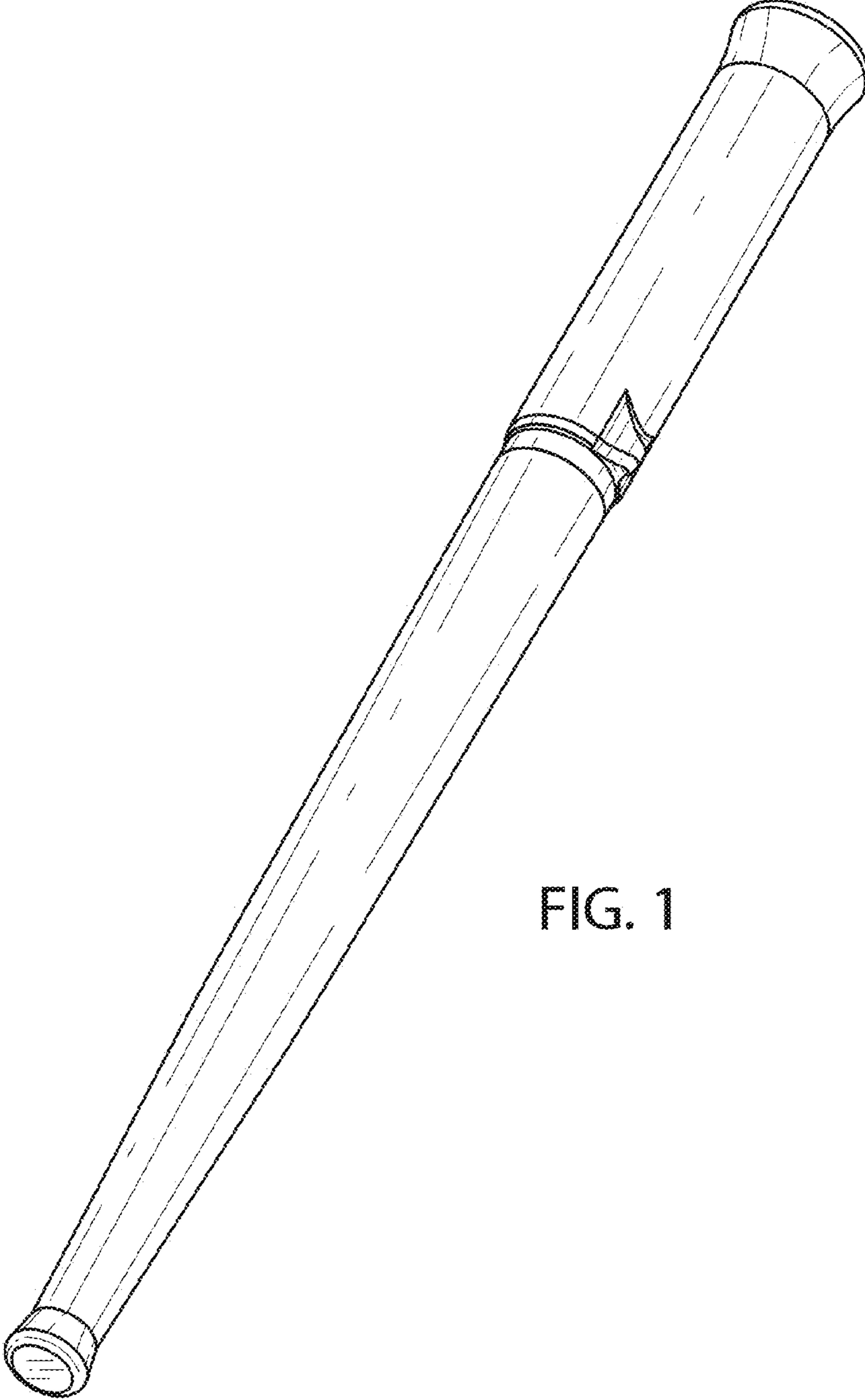

FIG. 1

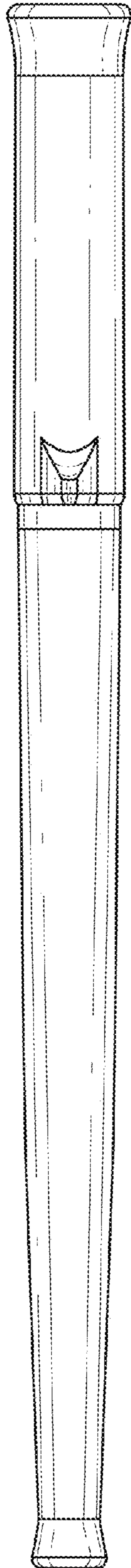

FIG. 2

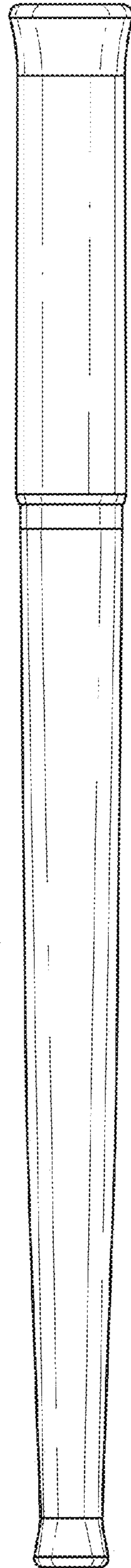

FIG. 3

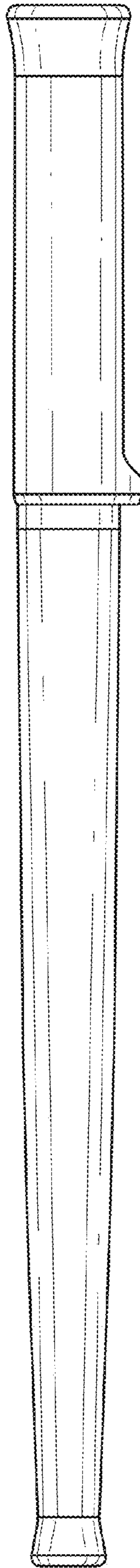

FIG. 4

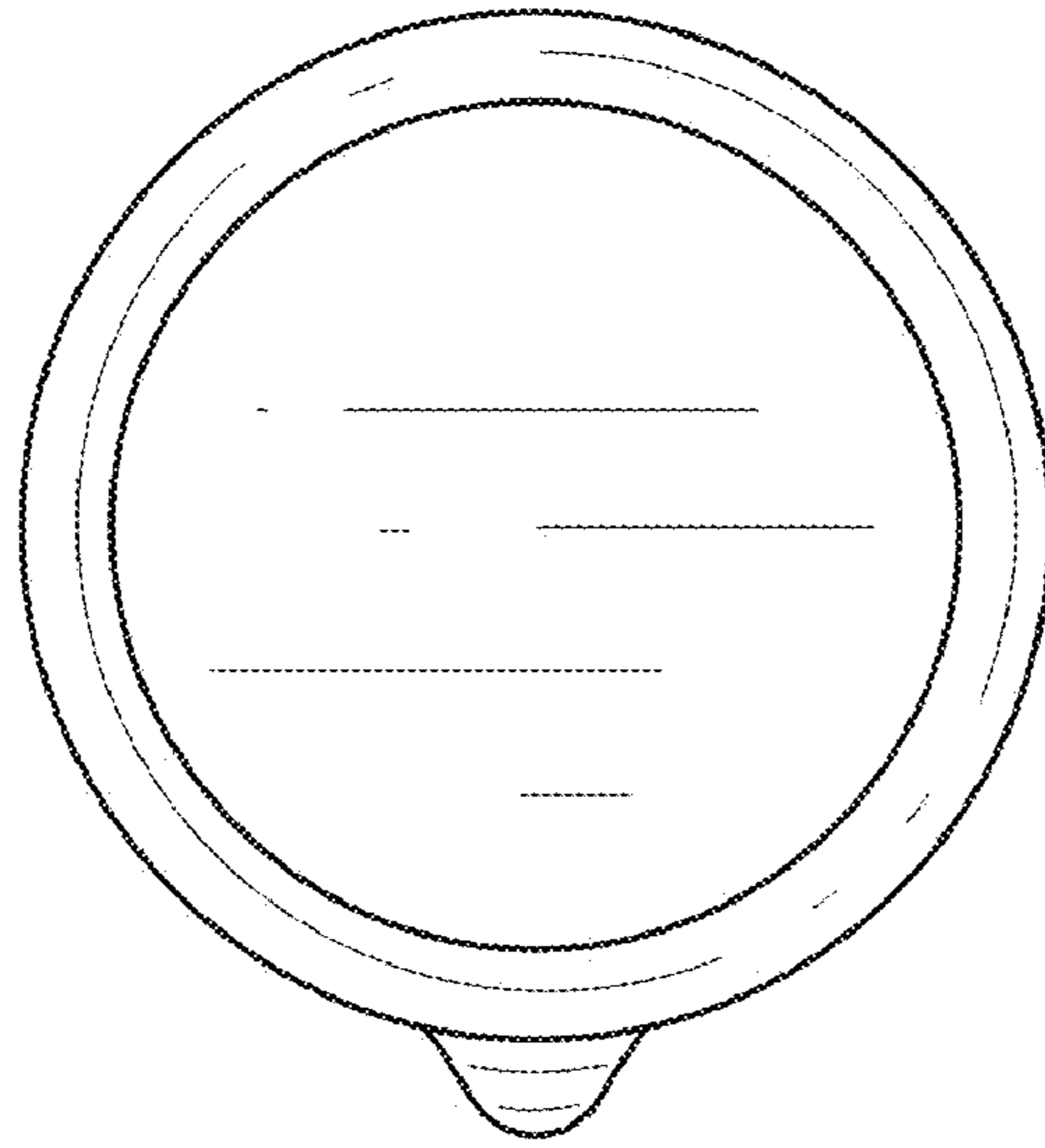

FIG. 5

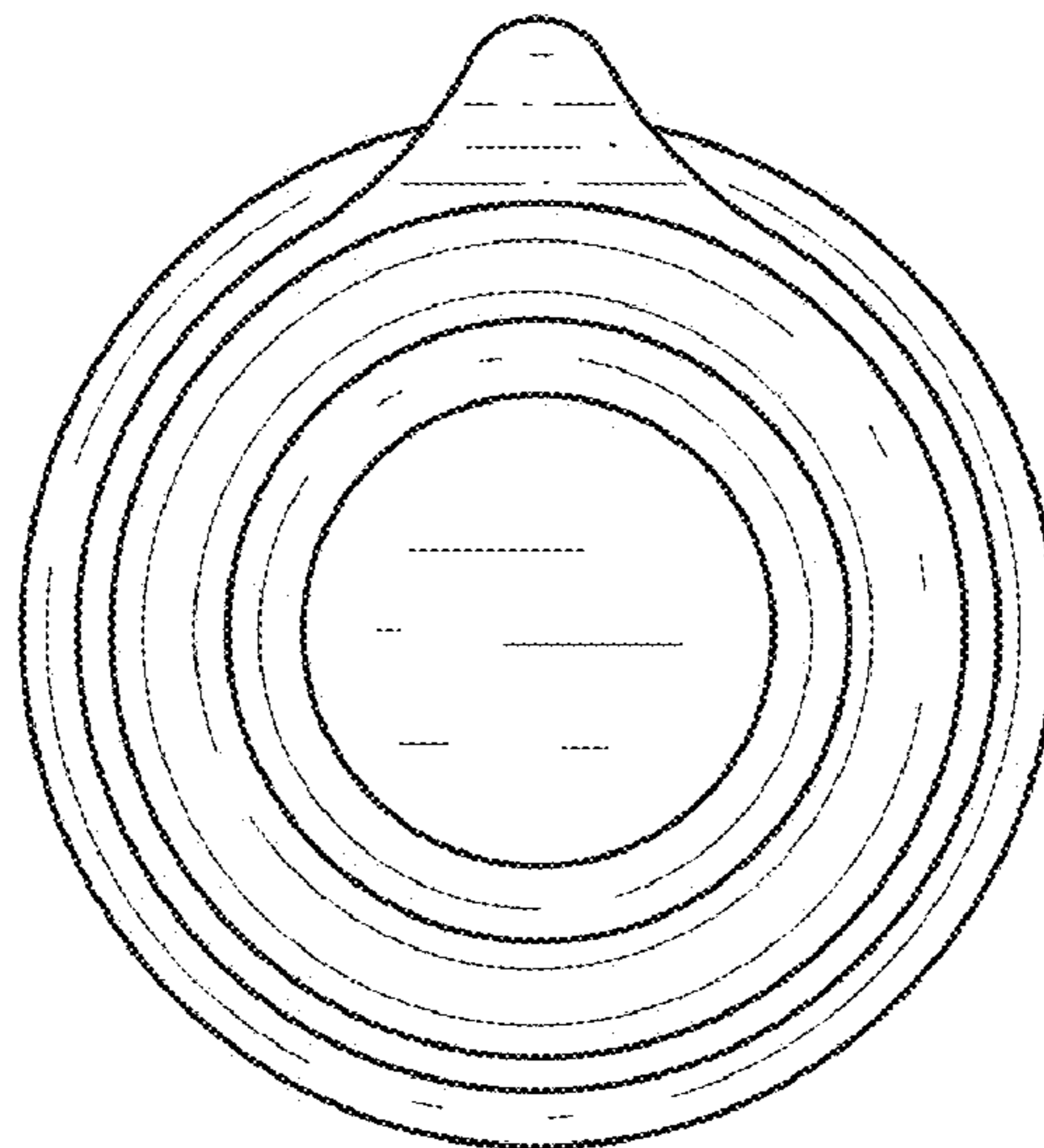

FIG. 6