



US00D678887S

(12) **United States Design Patent**
Stravitz

(10) **Patent No.:** **US D678,887 S**
(45) **Date of Patent:** **** Mar. 26, 2013**

(54) **MONITOR STAND AND ORGANIZER**

(71) Applicant: **David M. Stravitz**, New York, NY (US)

(72) Inventor: **David M. Stravitz**, New York, NY (US)

(73) Assignee: **Block and Company, Inc.**, Wheeling, IL (US)

(**) Term: **14 Years**

(21) Appl. No.: **29/438,274**

(22) Filed: **Nov. 28, 2012**

(51) **LOC (9) Cl.** **08-07**

(52) **U.S. Cl.** **D14/451**

(58) **Field of Classification Search** D14/224,
D14/239, 251, 253, 316, 375, 376, 432, 439,
D14/447, 451, 452, 457; D6/444, 513, 396,
D6/449, 510, 511; D8/349, 355, 363, 373,
D8/380; 248/121, 124.1, 127, 176.1, 177.1,
248/201, 205.1, 274.1, 276.1, 291.1, 309.1,
248/313, 346.01, 346.03, 371, 415, 917-24;
312/223.3; 348/825, 836, 446, 454; 211/134,
211/151; D19/87

See application file for complete search history.

(56) **References Cited**

U.S. PATENT DOCUMENTS

D269,749 S * 7/1983 Foster D6/475
D274,730 S * 7/1984 Hovey et al. D14/451
D279,847 S * 7/1985 Hanover D6/510
D470,533 S * 2/2003 Stravitz D19/87

D478,632 S * 8/2003 Chen D19/87
D480,088 S * 9/2003 Bakker et al. D14/447
D516,562 S * 3/2006 Solomon et al. D14/434
D557,698 S * 12/2007 Lye D14/447
D564,529 S * 3/2008 Hughes D14/451
D568,889 S * 5/2008 Hughes et al. D14/451
D569,380 S * 5/2008 Beilstein et al. D14/447
D577,361 S * 9/2008 Beilstein et al. D14/447
D578,540 S * 10/2008 Bouwknecht et al. D14/447

* cited by examiner

Primary Examiner — Cynthia Ramirez

(74) *Attorney, Agent, or Firm* — Holtz, Holtz, Goodman & Chick PC

(57) **CLAIM**

The ornamental design for a monitor stand and organizer, as shown and described.

DESCRIPTION

FIG. 1 is a top, front, right side perspective view of a monitor stand and organizer showing my new design;
FIG. 2 is a top, front, left side perspective view thereof;
FIG. 3 is a top plan view thereof;
FIG. 4 is a bottom plan view thereof;
FIG. 5 is a front elevational view thereof;
FIG. 6 is a rear elevational view thereof;
FIG. 7 is a left side elevational view thereof;
FIG. 8 is a right side elevational view thereof; and,
FIG. 9 is a rear, top, right side perspective view thereof.
The broken line portions of the drawings are for illustrative purposes only, and form no part of the claimed design.

1 Claim, 8 Drawing Sheets

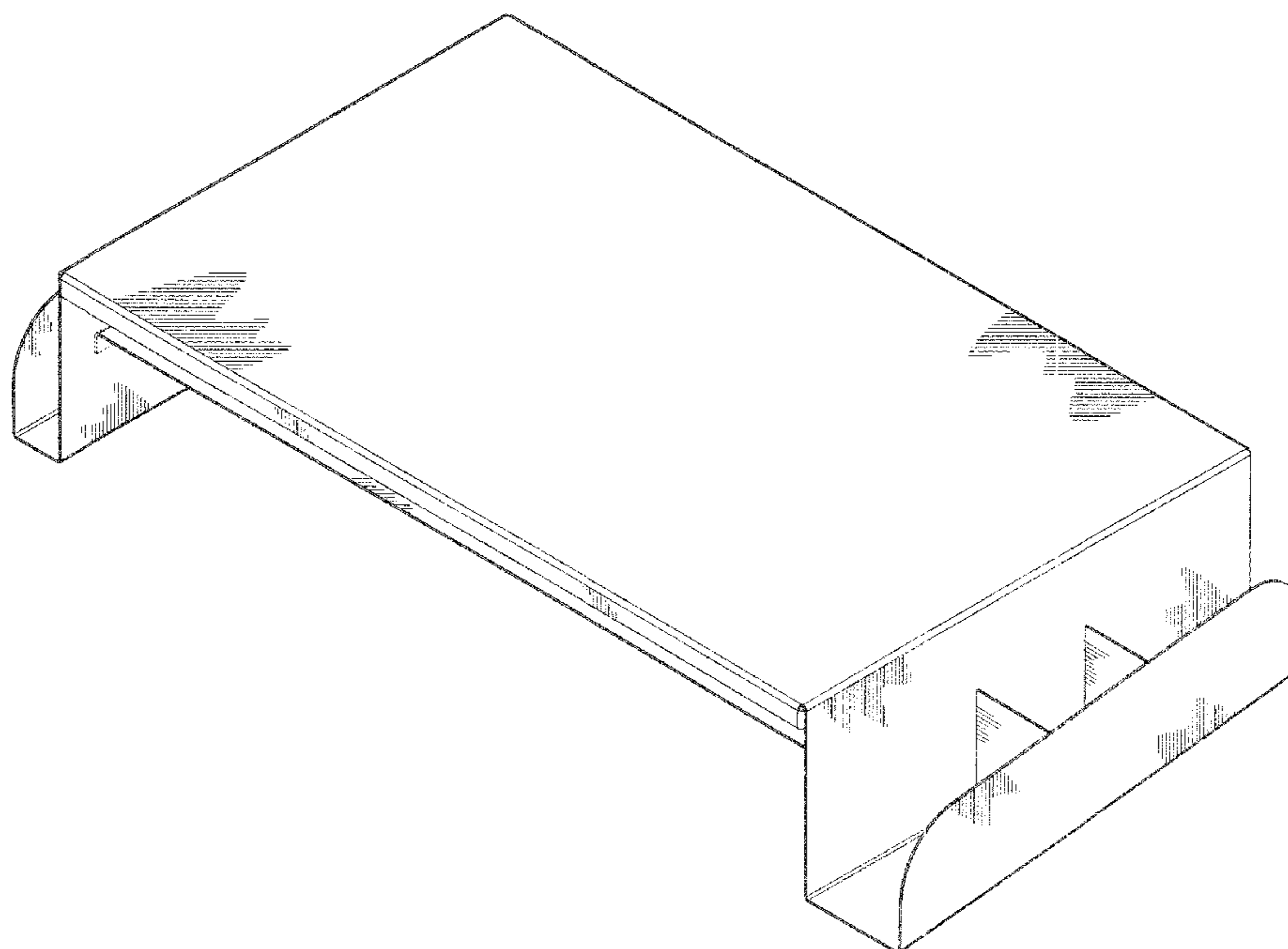

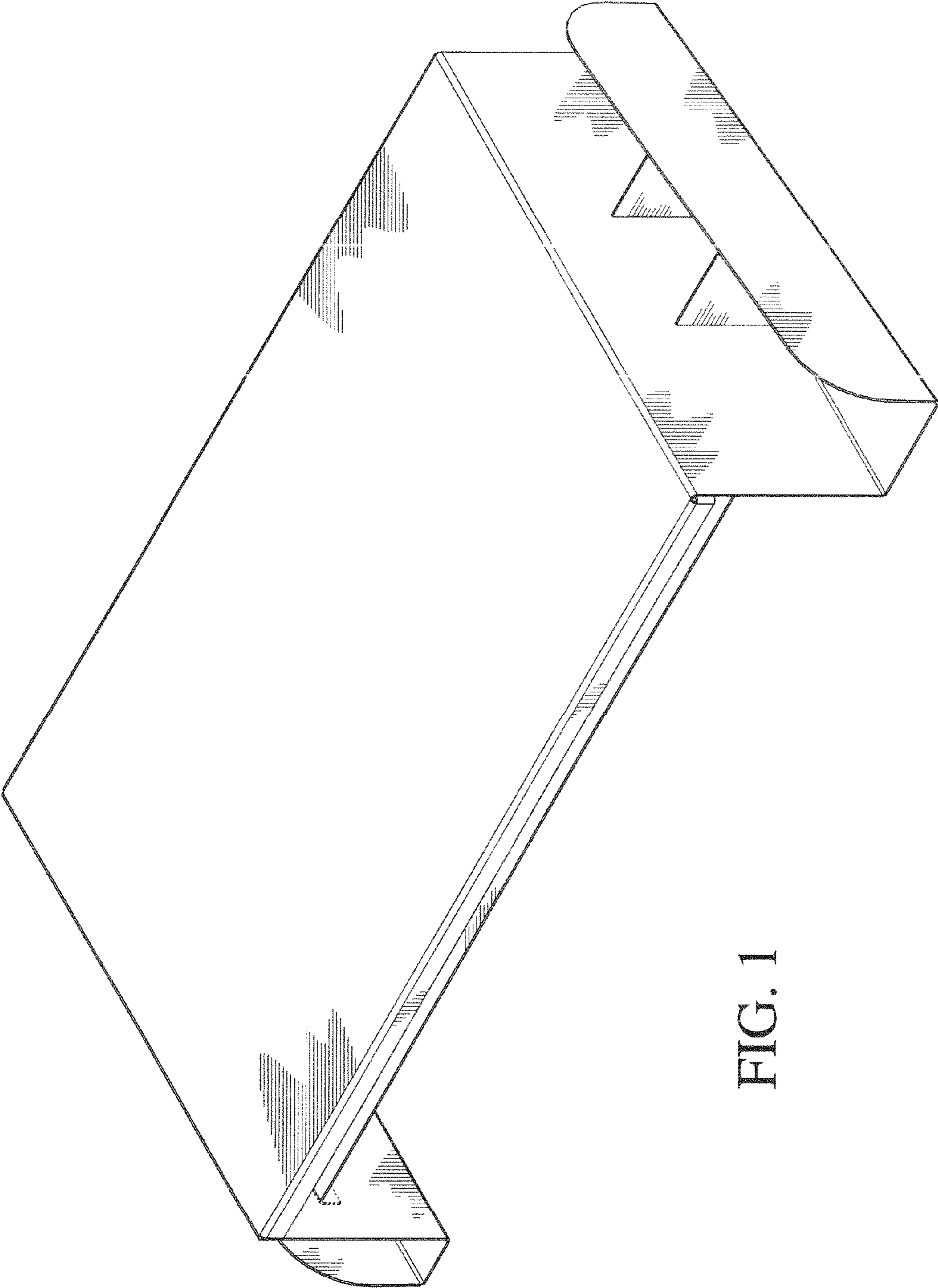

FIG. 1

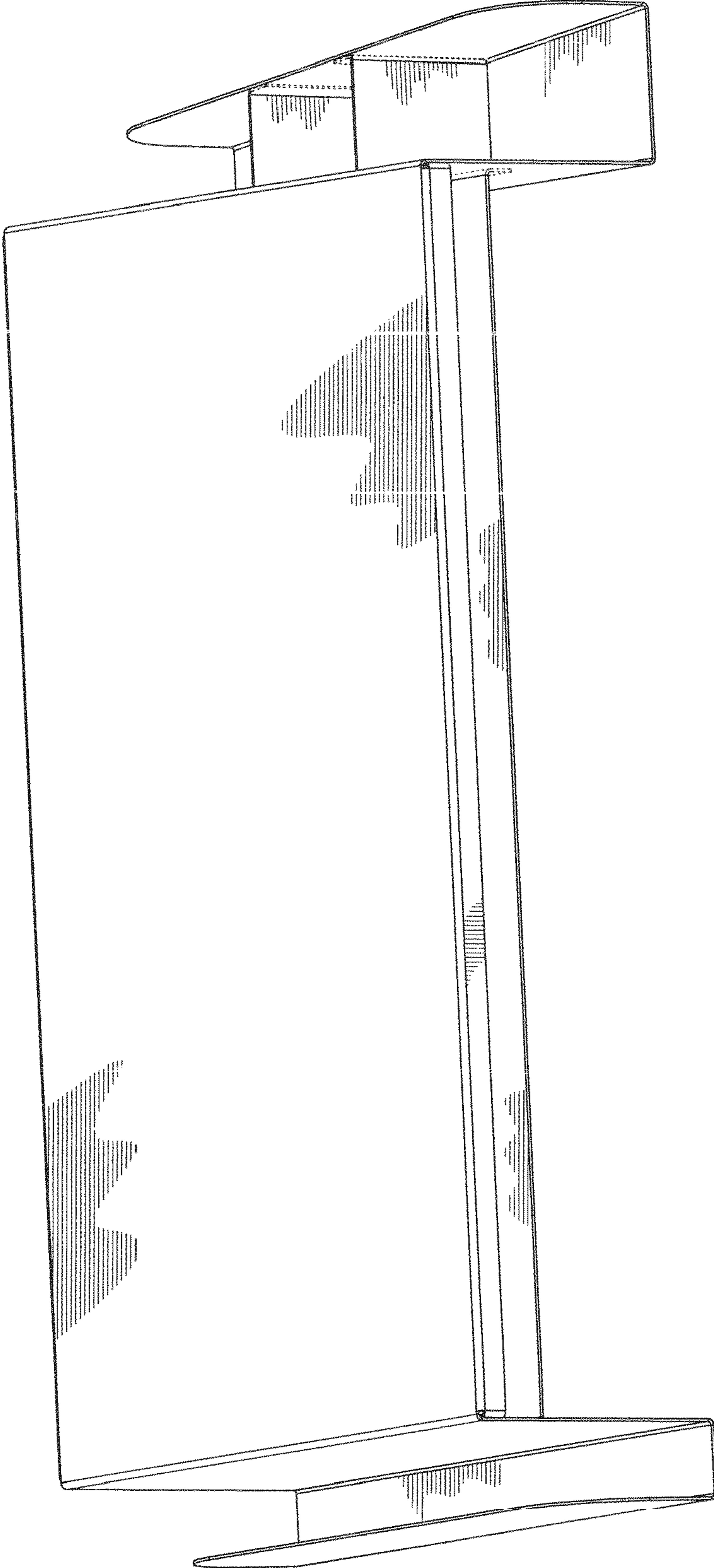

FIG. 2

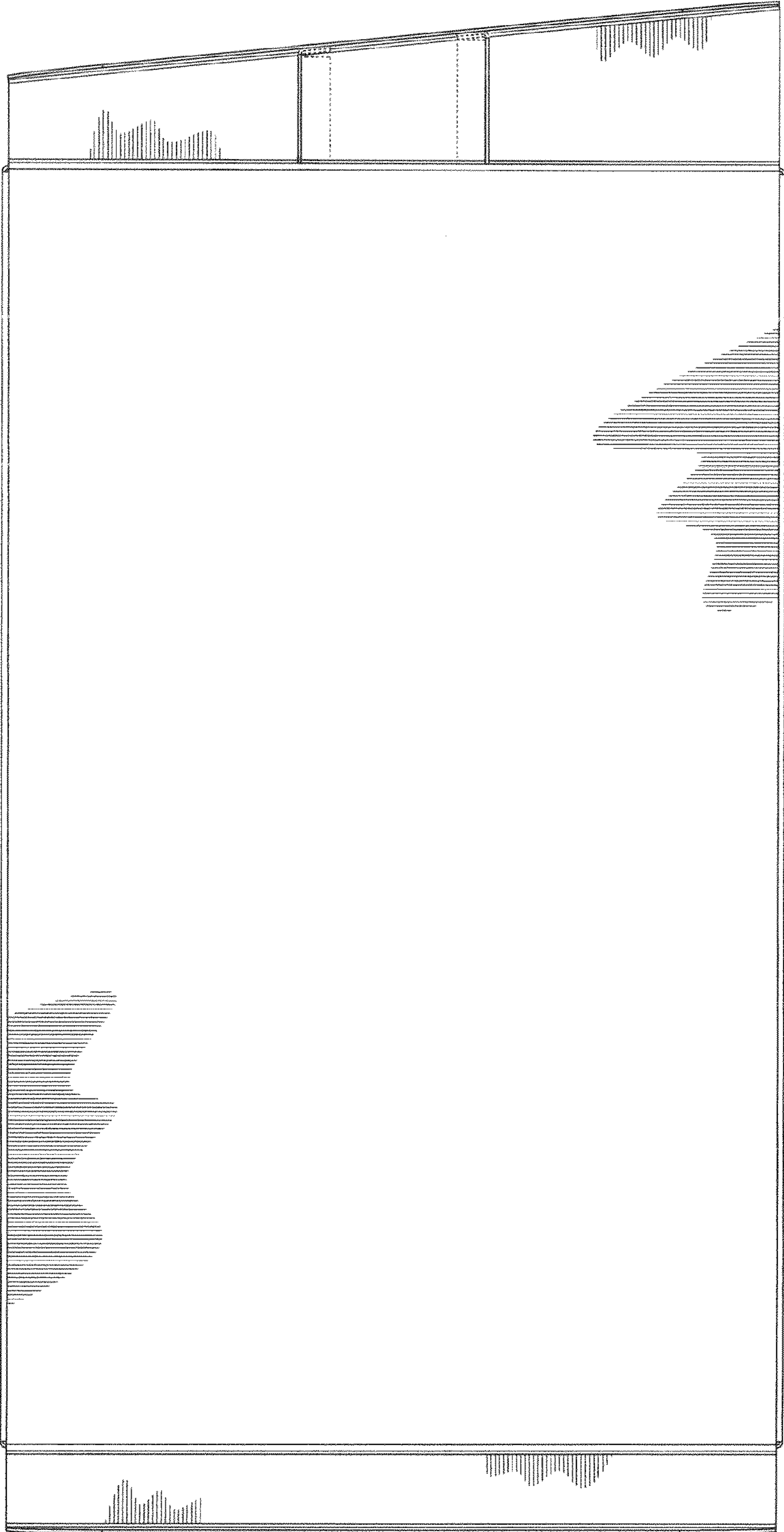

FIG. 3

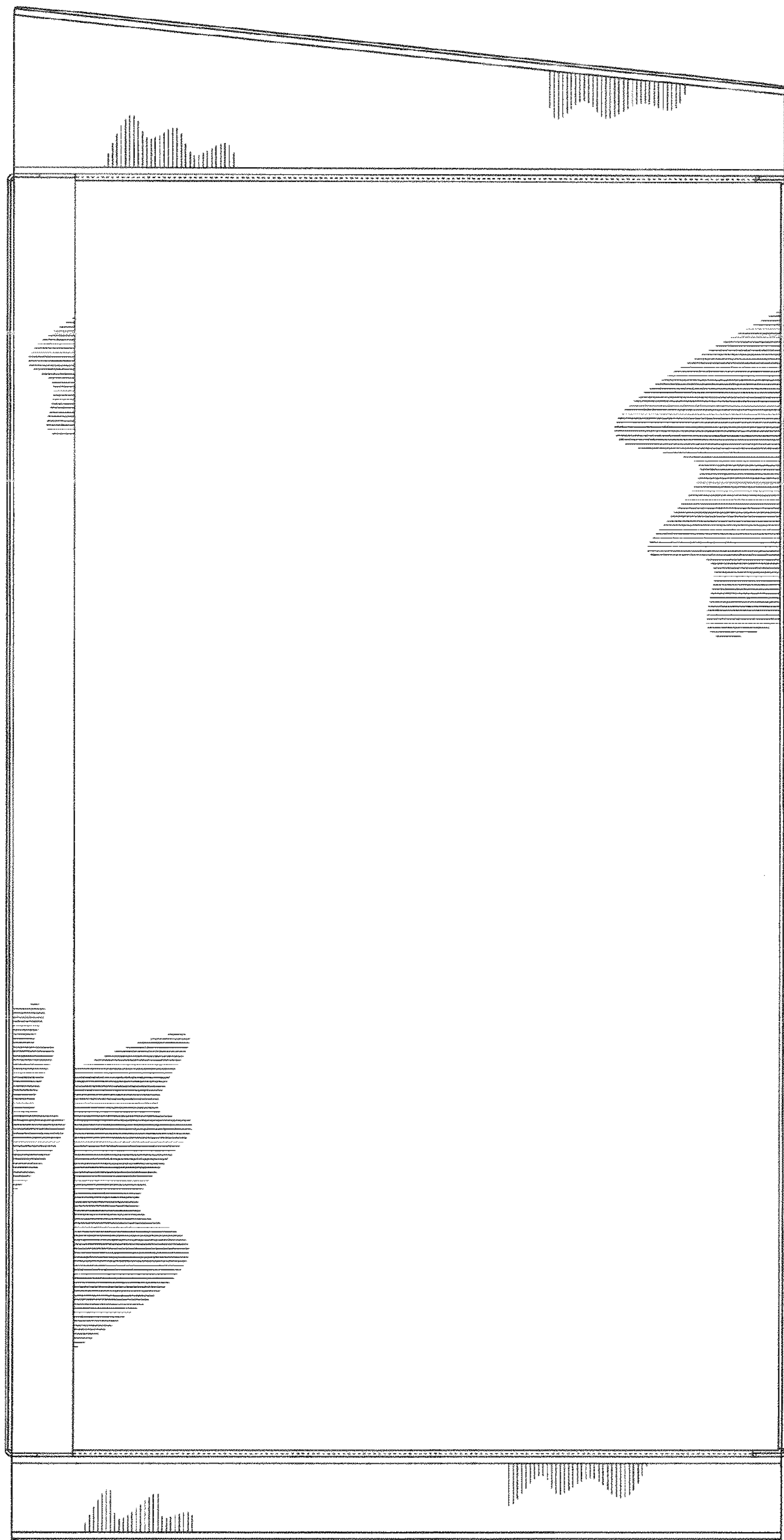

FIG. 4

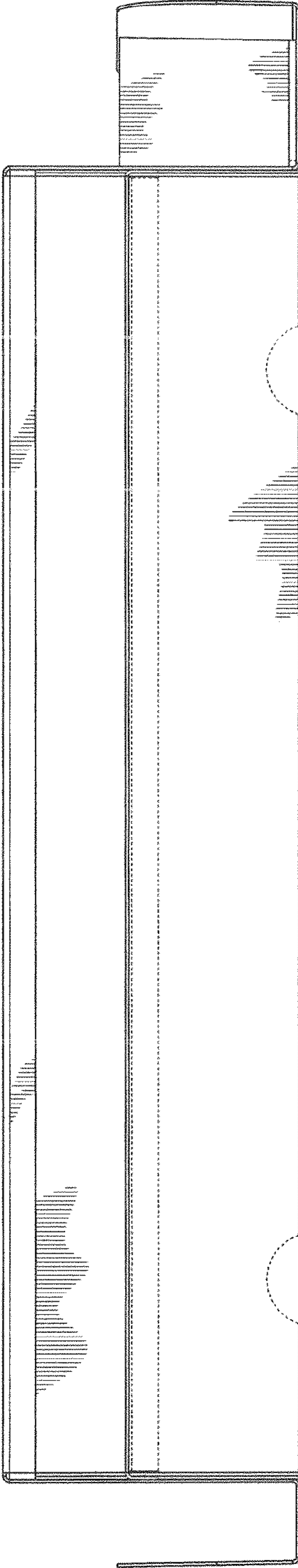

FIG. 5

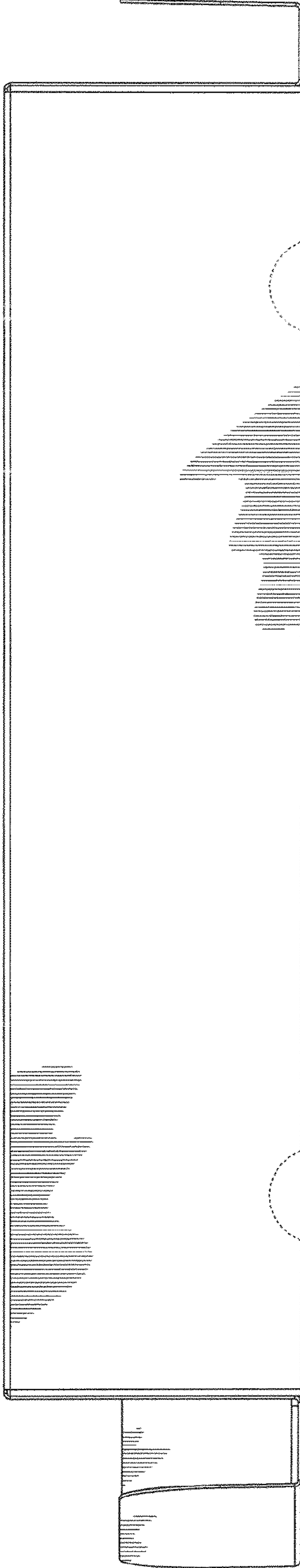

FIG. 6

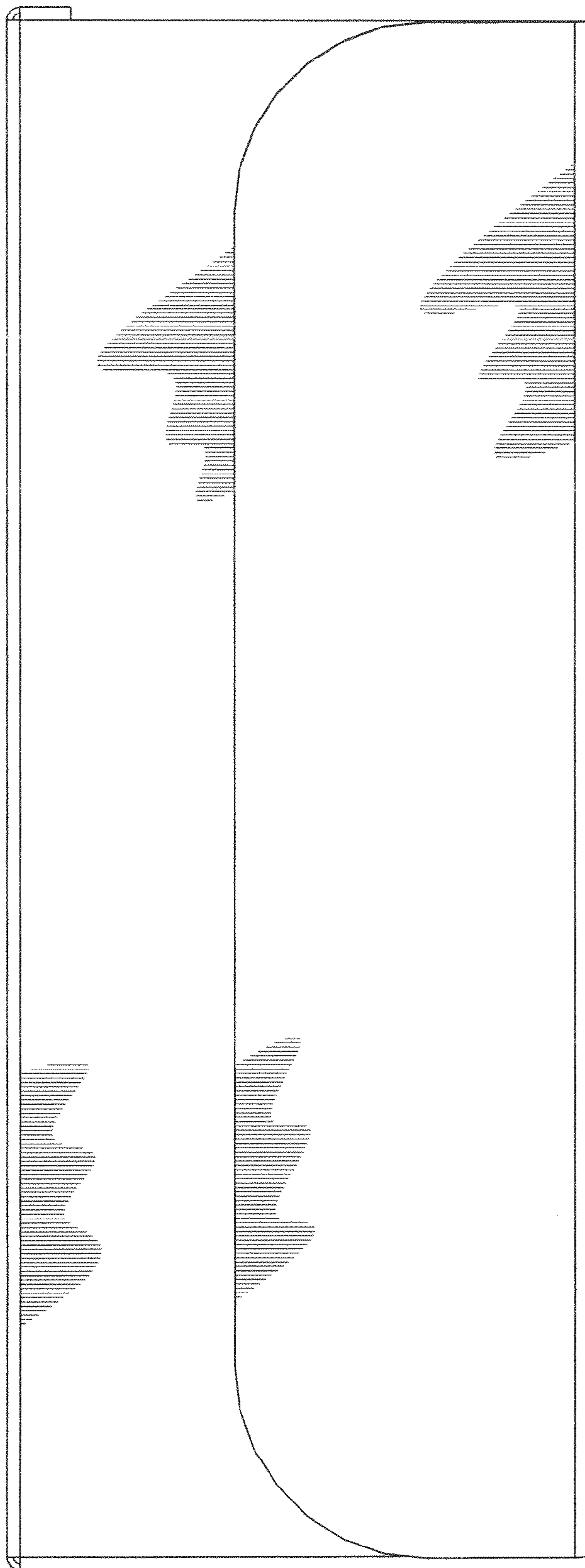

FIG. 7

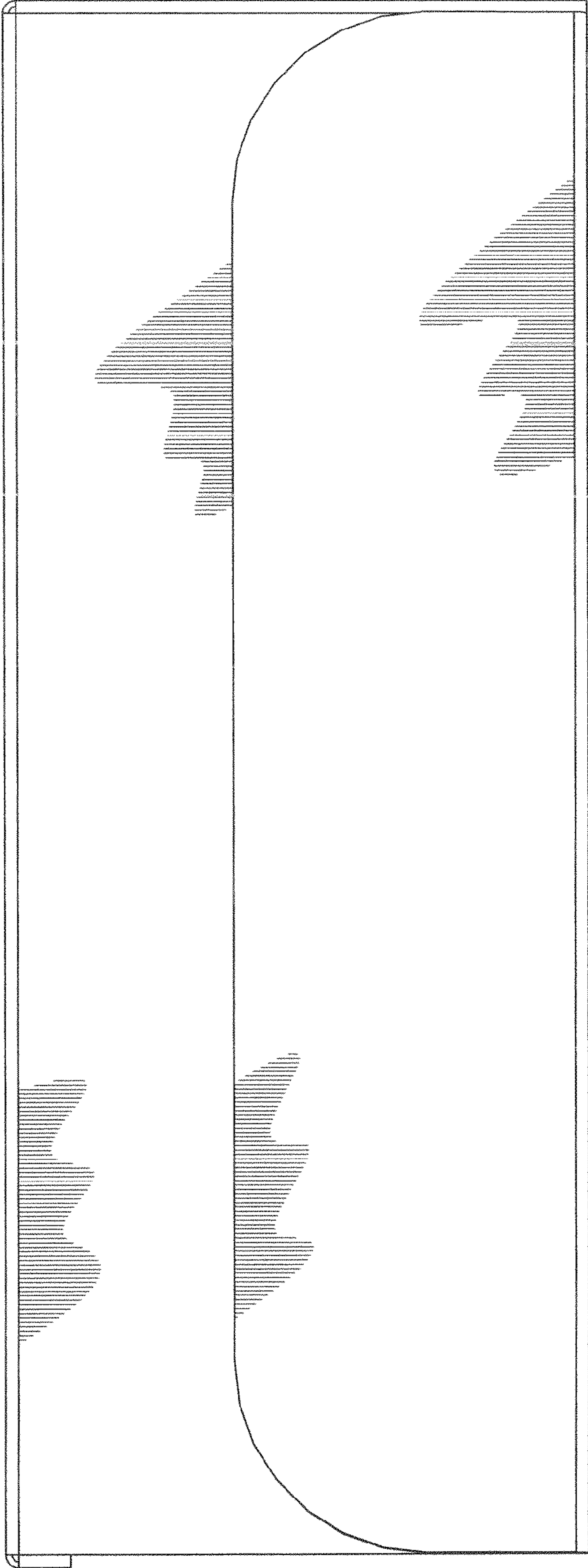

FIG. 8

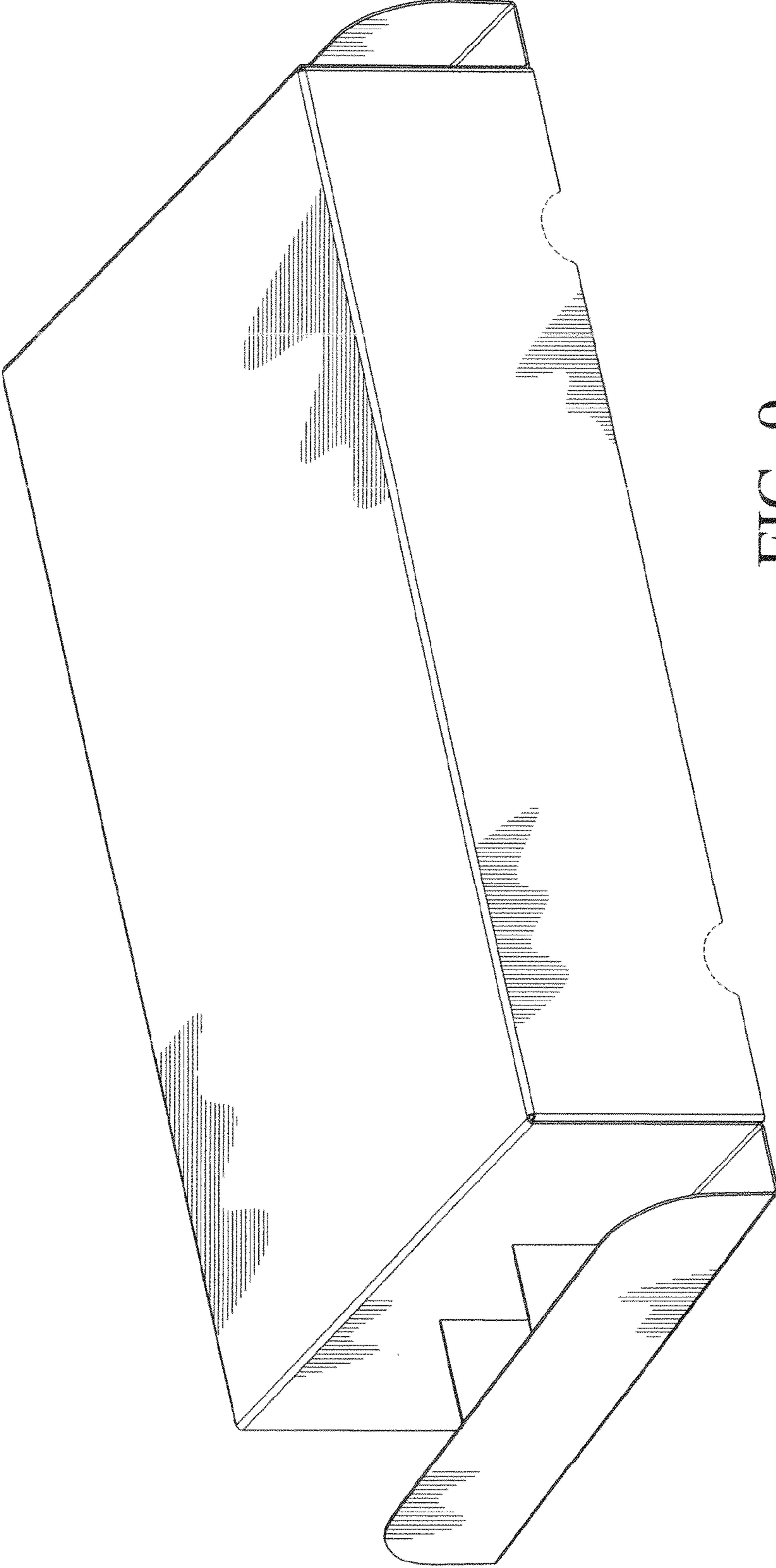

FIG. 9