



US00D678868S

(12) **United States Design Patent**
Feng et al.

(10) **Patent No.:** **US D678,868 S**
(45) **Date of Patent:** **** Mar. 26, 2013**

(54) **EAR BUD ADAPTER**

(75) Inventors: **Feng Feng**, Chesterfield, MO (US); **Seth Burgett**, Glen Carbon, IL (US); **Richard J. Daniels**, St. Louis, MO (US)

(73) Assignee: **Verto Medical Solutions, LLC**, St. Louis, MO (US)

(**) Term: **14 Years**

(21) Appl. No.: **29/405,993**

(22) Filed: **Nov. 8, 2011**

(51) **LOC (9) Cl.** **14-01**

(52) **U.S. Cl.** **D14/223**

(58) **Field of Classification Search** D14/205,
D14/206, 223; 181/129, 130, 135; 379/430,
379/431; 381/380, 381, 322; 128/864, 865;
D24/106, 174

See application file for complete search history.

(56) **References Cited**

U.S. PATENT DOCUMENTS

1,893,474	A *	1/1933	Lieber	381/380
2,148,477	A *	2/1939	Koch	381/151
2,325,590	A *	7/1943	Carlisle et al.	381/328
2,344,023	A *	3/1944	Carlisle et al.	381/328
D242,810	S *	12/1976	Rynearson	D14/205
D266,590	S *	10/1982	Bennett	D24/174
D273,707	S *	5/1984	McCall	D24/173
5,146,051	A *	9/1992	Hermann	181/130

D388,093	S *	12/1997	Frengley	D14/223
D478,991	S *	8/2003	Dyer et al.	D24/174
6,690,807	B1 *	2/2004	Meyer	381/327
D618,218	S *	6/2010	Burgett et al.	D14/223
D618,219	S *	6/2010	Burgett et al.	D14/223
D622,705	S *	8/2010	Fahrendorff et al.	D14/223
D645,455	S *	9/2011	Manhard et al.	D14/223
8,111,863	B2 *	2/2012	Oliveira et al.	381/381
8,111,864	B2 *	2/2012	Oliveira et al.	381/381

* cited by examiner

Primary Examiner — Paula Greene

(74) *Attorney, Agent, or Firm* — **Herness, Dickey & Pierce, P.L.C.**

(57) **CLAIM**

The ornamental design for ear bud adapter, as shown and described.

DESCRIPTION

FIG. 1 is a perspective view of the ear bud adapter, in accordance with our new design;

FIG. 2 is a right-side elevation view thereof;

FIG. 3 is a left-side elevation view thereof;

FIG. 4 is a front elevation view thereof;

FIG. 5 is rear elevation view thereof;

FIG. 6 is top plan view thereof; and,

FIG. 7 is bottom plan view thereof.

The matter shown in broken lines do not form part of the claimed design.

1 Claim, 4 Drawing Sheets

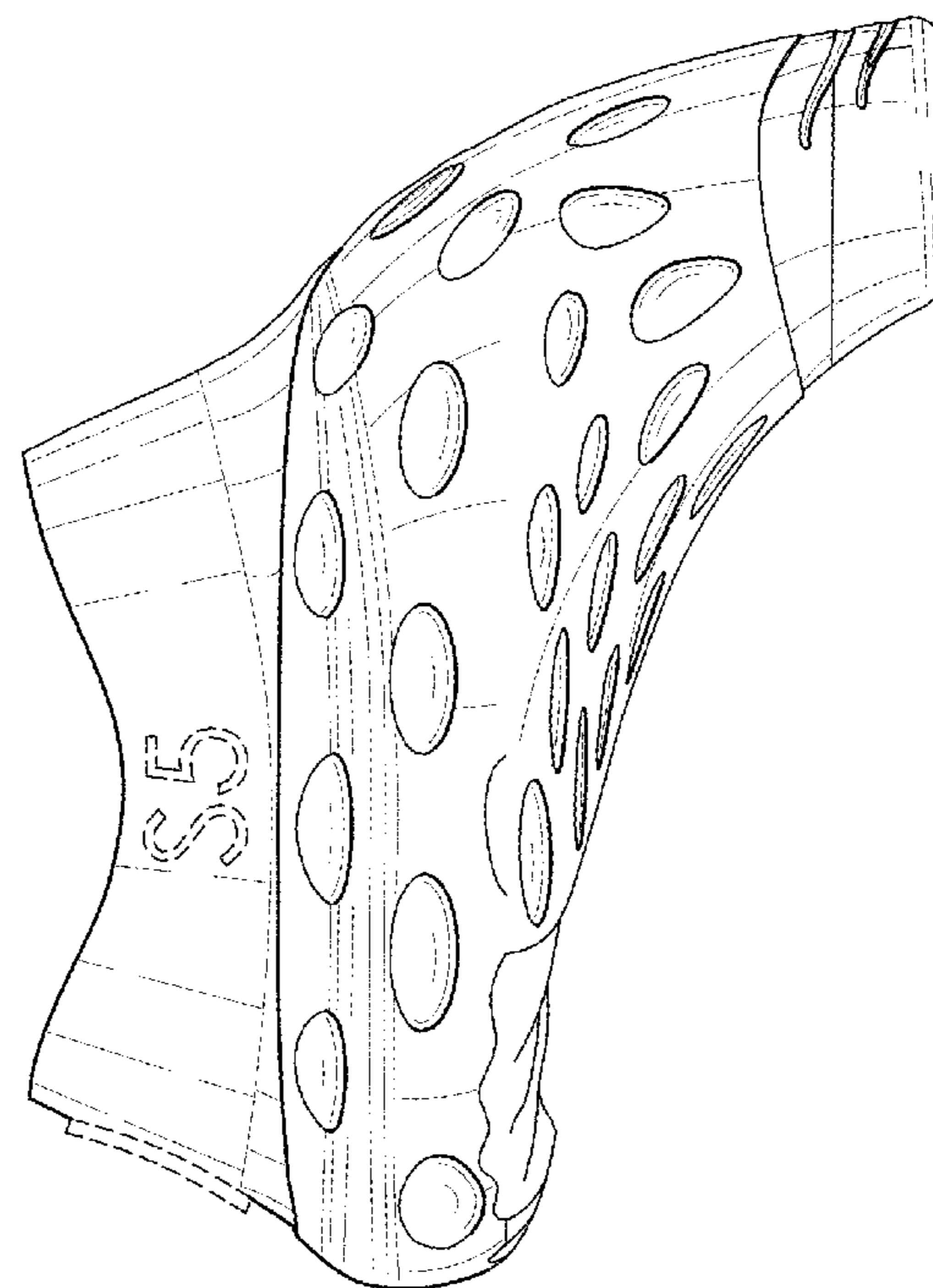
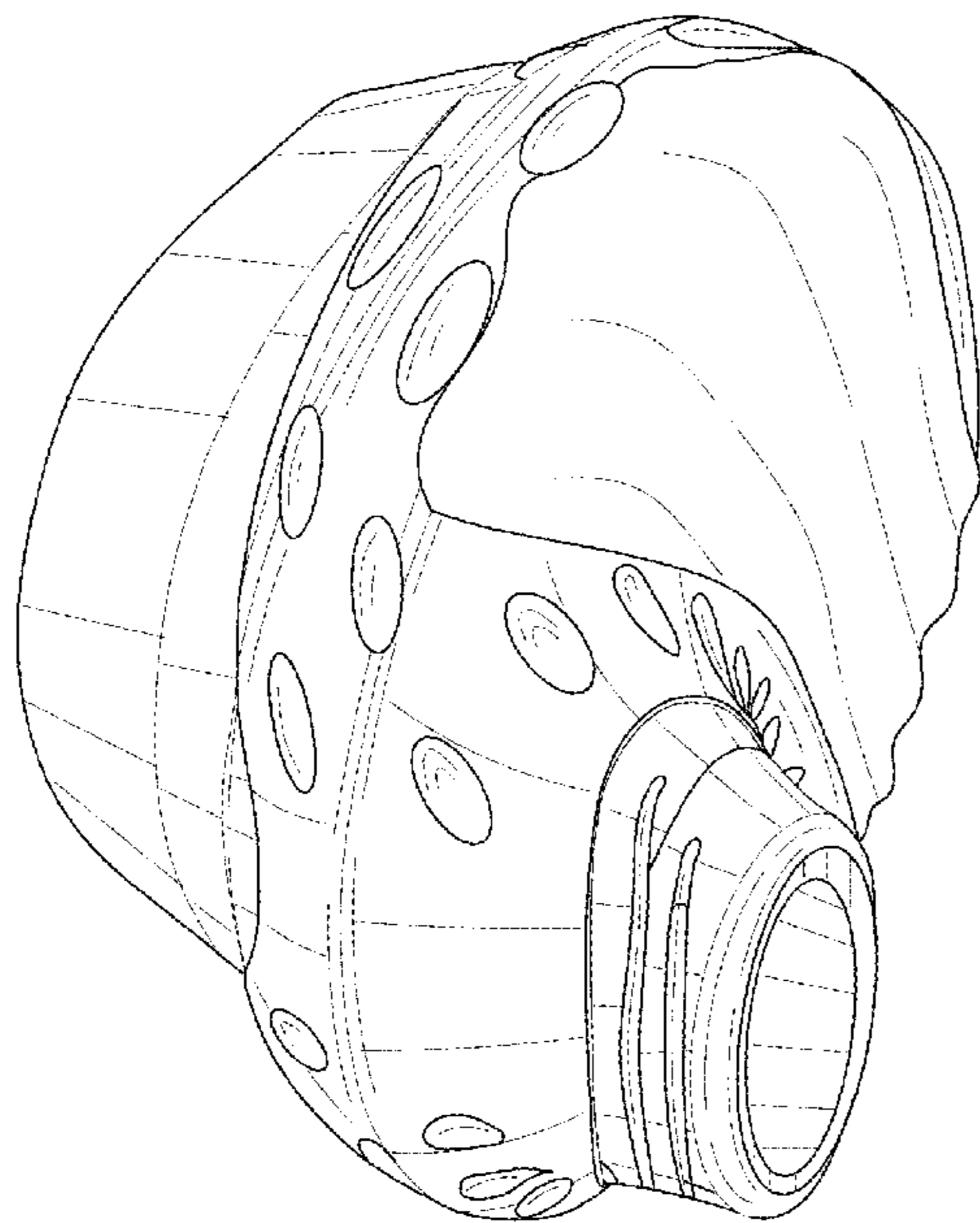

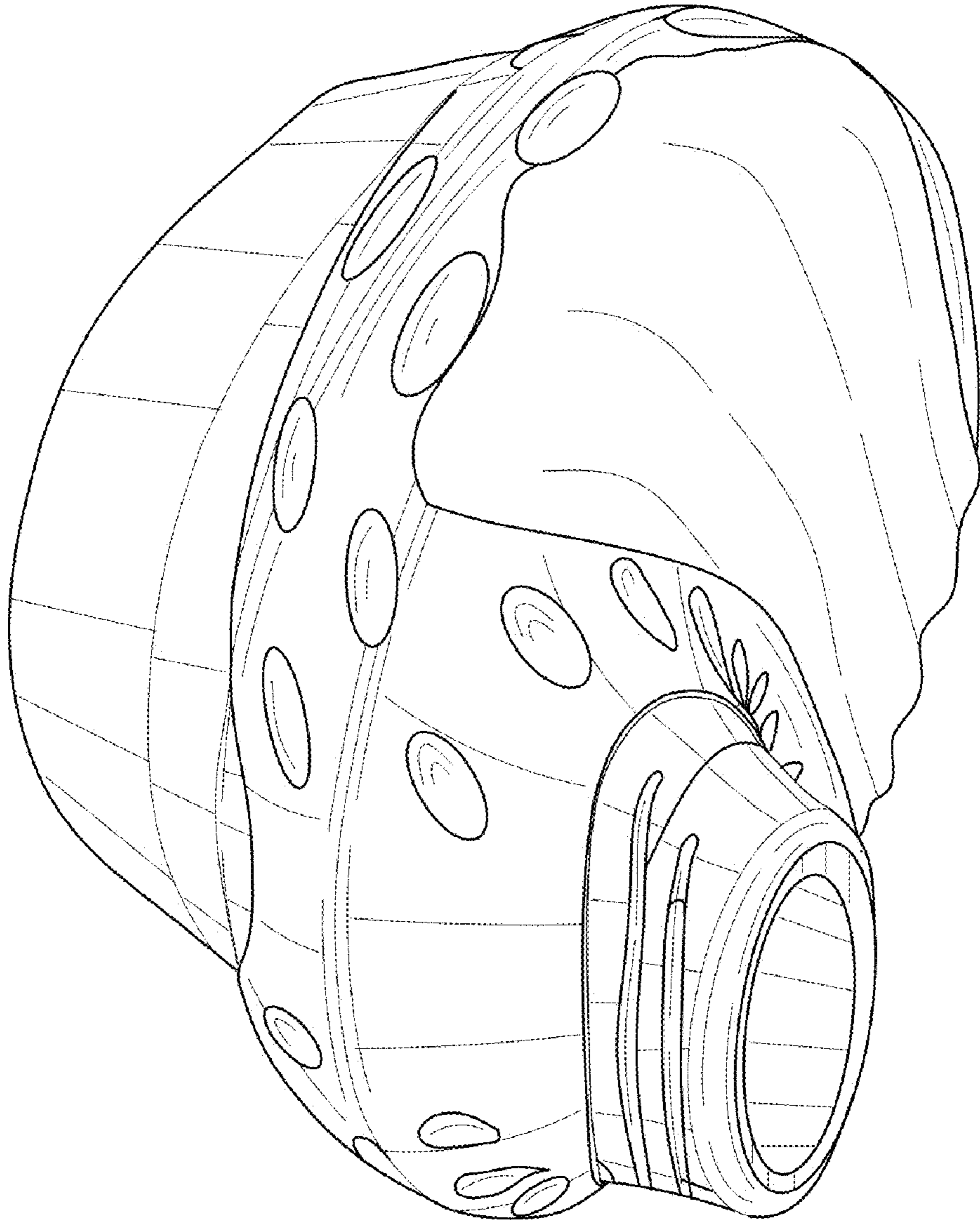

FIG. 1

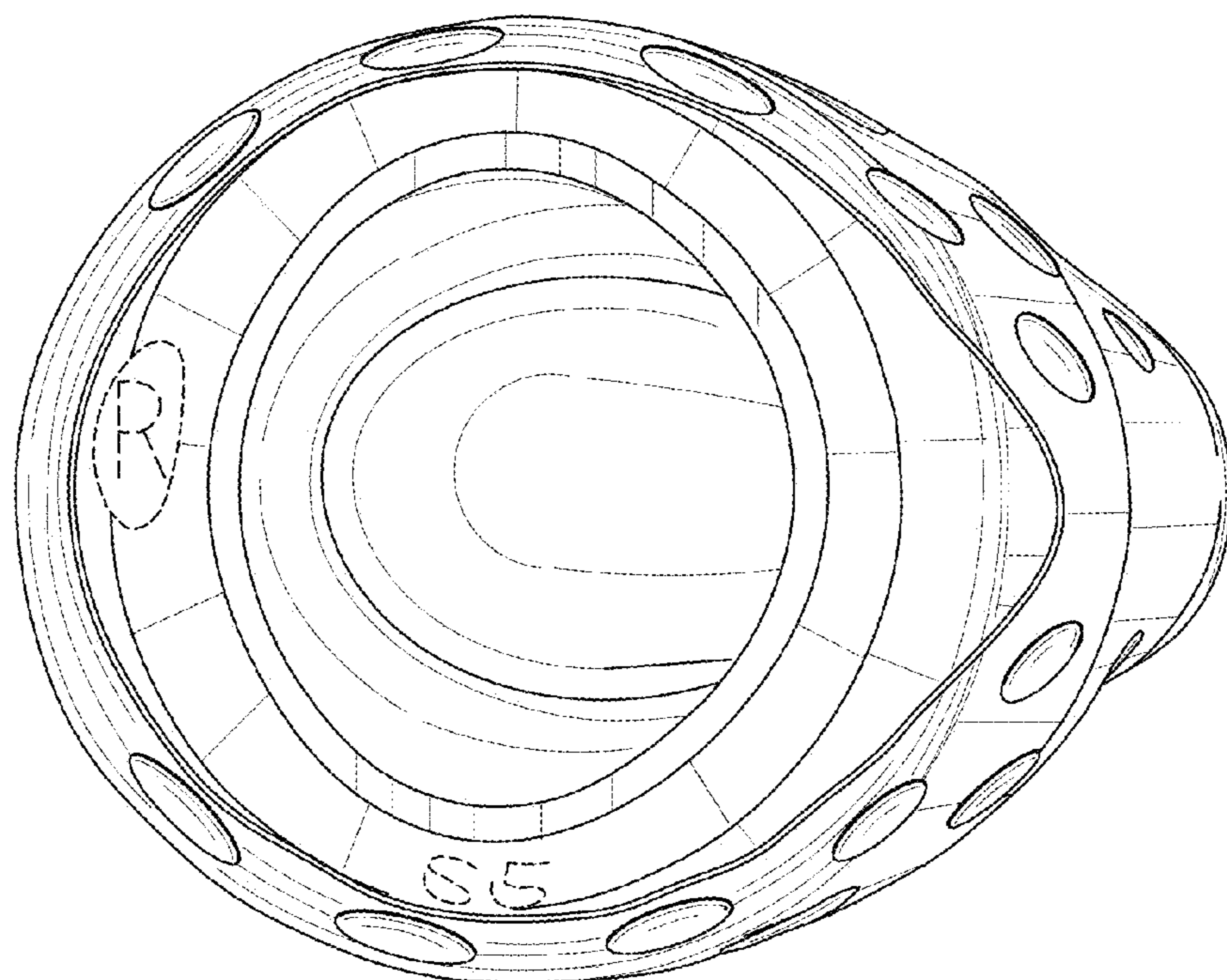

FIG. 2

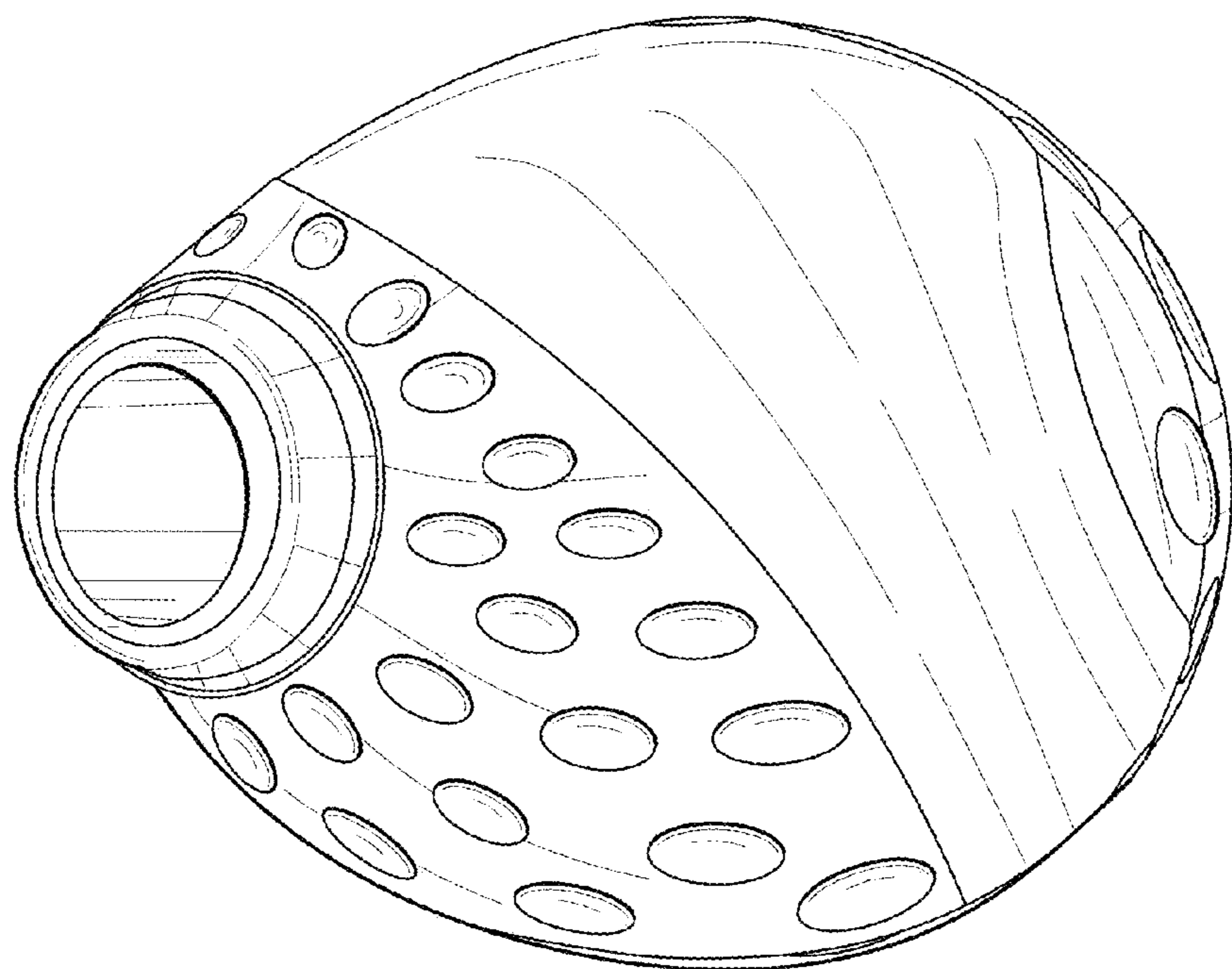

FIG. 3

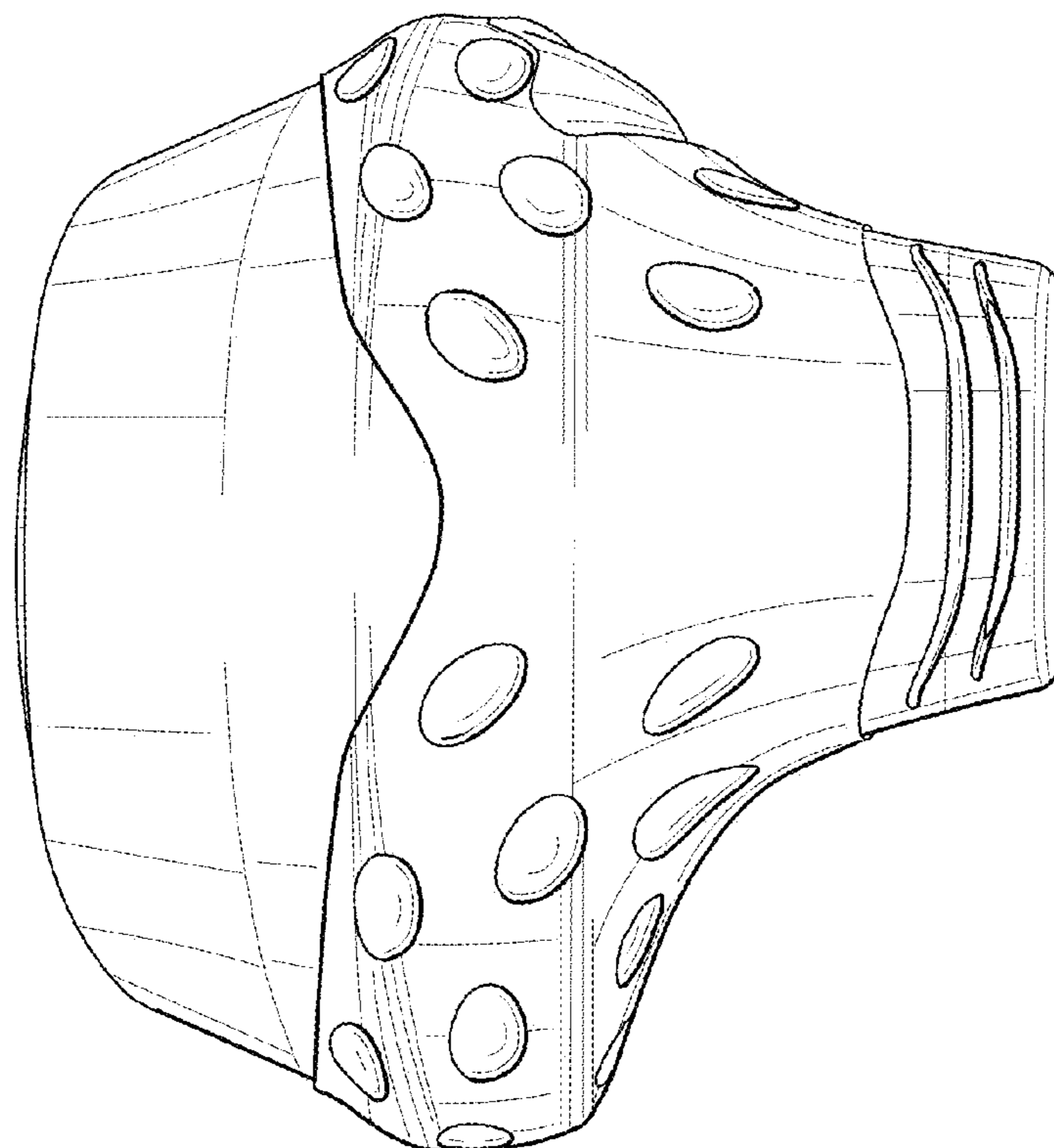

FIG. 4

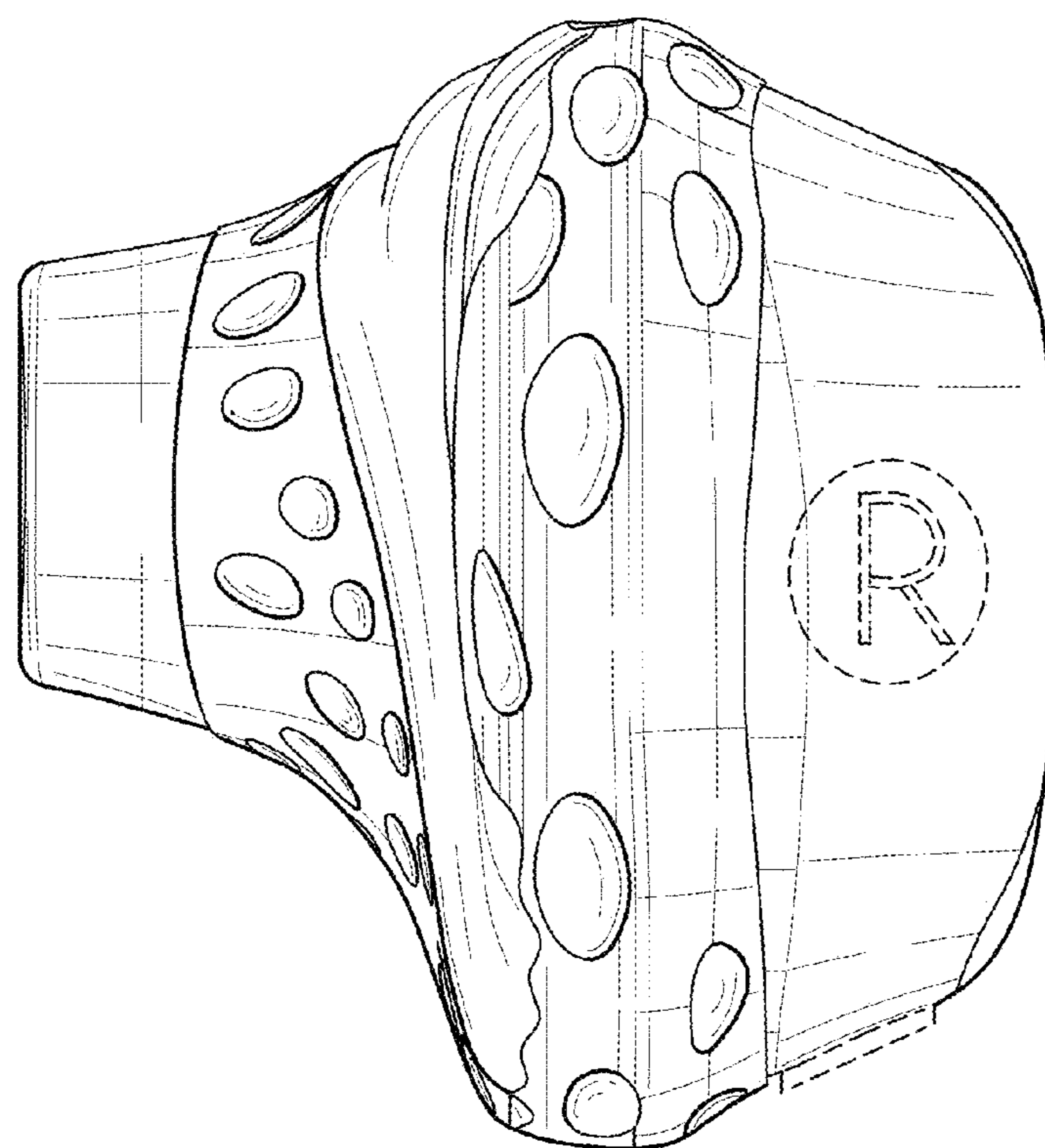

FIG. 5

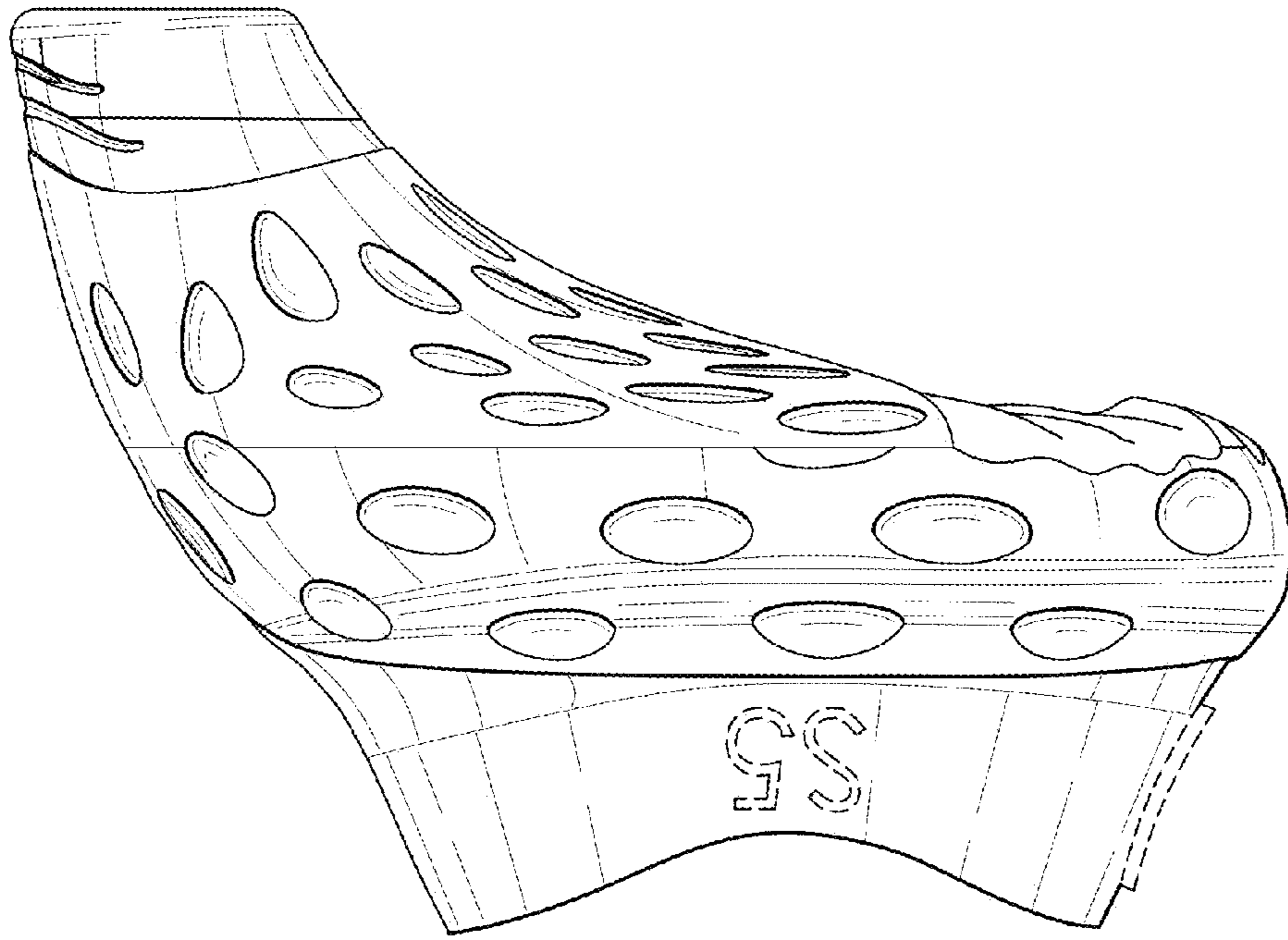

FIG. 7

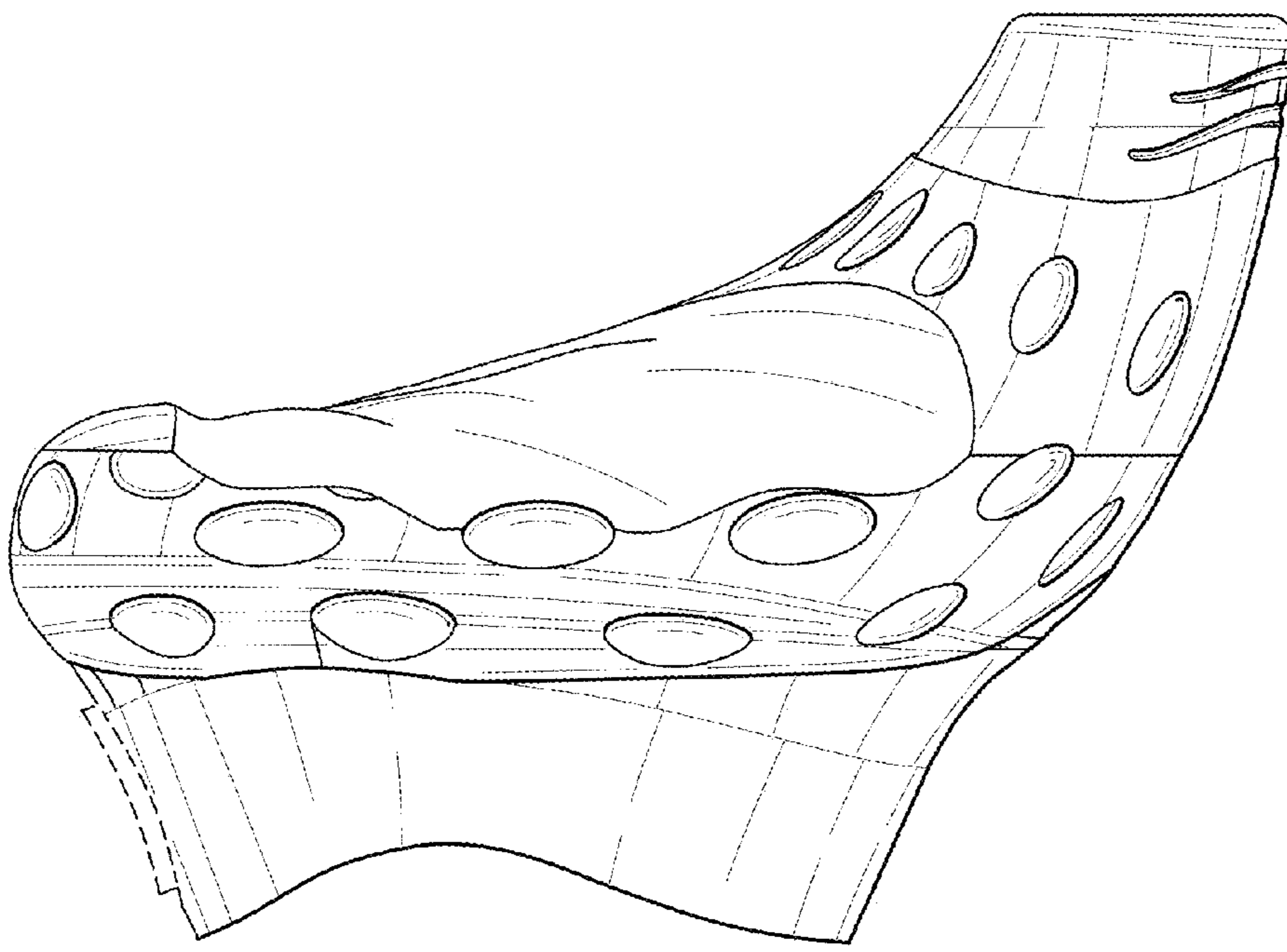

FIG. 6