



US00D678865S

(12) **United States Design Patent**
Behar et al.

(10) **Patent No.:** **US D678,865 S**

(45) **Date of Patent:** **** Mar. 26, 2013**

(54) **SPEAKER**

(75) Inventors: **Yves Albert Behar**, San Francisco, CA (US); **Gabriel J. Lamb**, San Francisco, CA (US); **William Hardy Chambliss**, San Francisco, CA (US)

(73) Assignee: **Aliphcom**, San Francisco, CA (US)

(**) Term: **14 Years**

(21) Appl. No.: **29/413,572**

(22) Filed: **Feb. 16, 2012**

(51) **LOC (9) Cl.** **14-03**

(52) **U.S. Cl.** **D14/214**

(58) **Field of Classification Search** D14/172,
D14/194, 196, 204, 207, 210–216; 181/143,
181/144, 147, 148, 150, 153, 157, 198, 199;
381/300–303, 306, 332, 333, 336, 345, 361–364,
381/386–388

See application file for complete search history.

(56) **References Cited**

U.S. PATENT DOCUMENTS

D489,707 S *	5/2004	Kobayashi	D14/214
D531,986 S	11/2006	Azumi et al.		
D546,318 S	7/2007	Yoon et al.		
D568,289 S *	5/2008	Solland	D14/204
D589,939 S	4/2009	Hsu		
D597,529 S	8/2009	Tan et al.		
D645,024 S *	9/2011	Behar et al.	D14/214
D652,019 S *	1/2012	Behar et al.	D14/214
D652,020 S *	1/2012	Behar et al.	D14/214

OTHER PUBLICATIONS

Office Action in related U.S. Appl. 29/378,329 dated May 5, 2011.

* cited by examiner

Primary Examiner — Keli L Hill

(74) *Attorney, Agent, or Firm* — Kilpatrick Townsend & Stockton LLP

(57) **CLAIM**

The ornamental design for a speaker, as shown and described.

DESCRIPTION

FIG. 1 is a perspective view of a speaker showing our new design;
 FIG. 2 is a front elevational view thereof;
 FIG. 3 is a rear elevational view thereof;
 FIG. 4 is a top plan view thereof;
 FIG. 5 is a bottom plan view thereof;
 FIG. 6 is a right side elevational view thereof;
 FIG. 7 is a left side elevational view thereof;
 FIG. 8 is a duplicate of FIG. 2 showing section views **9-9** and **10-10**;
 FIG. 9 corresponds with section **9-9** of FIG. 8; and,
 FIG. 10 corresponds with section **10-10** of FIG. 8.
 The broken lines shown are included for the purpose of illustrating the unclaimed portions of the article and form no part of the claim.

1 Claim, 4 Drawing Sheets

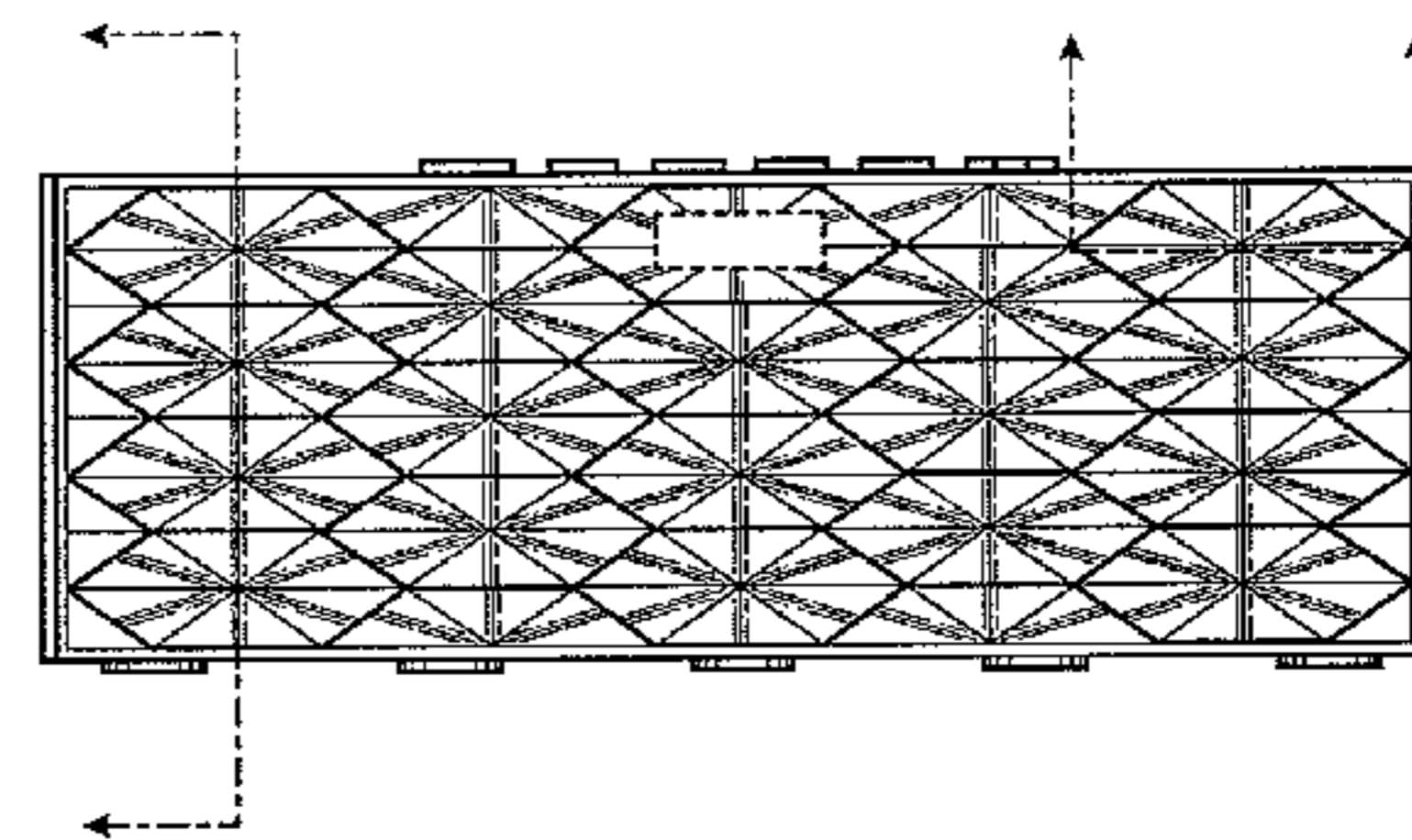
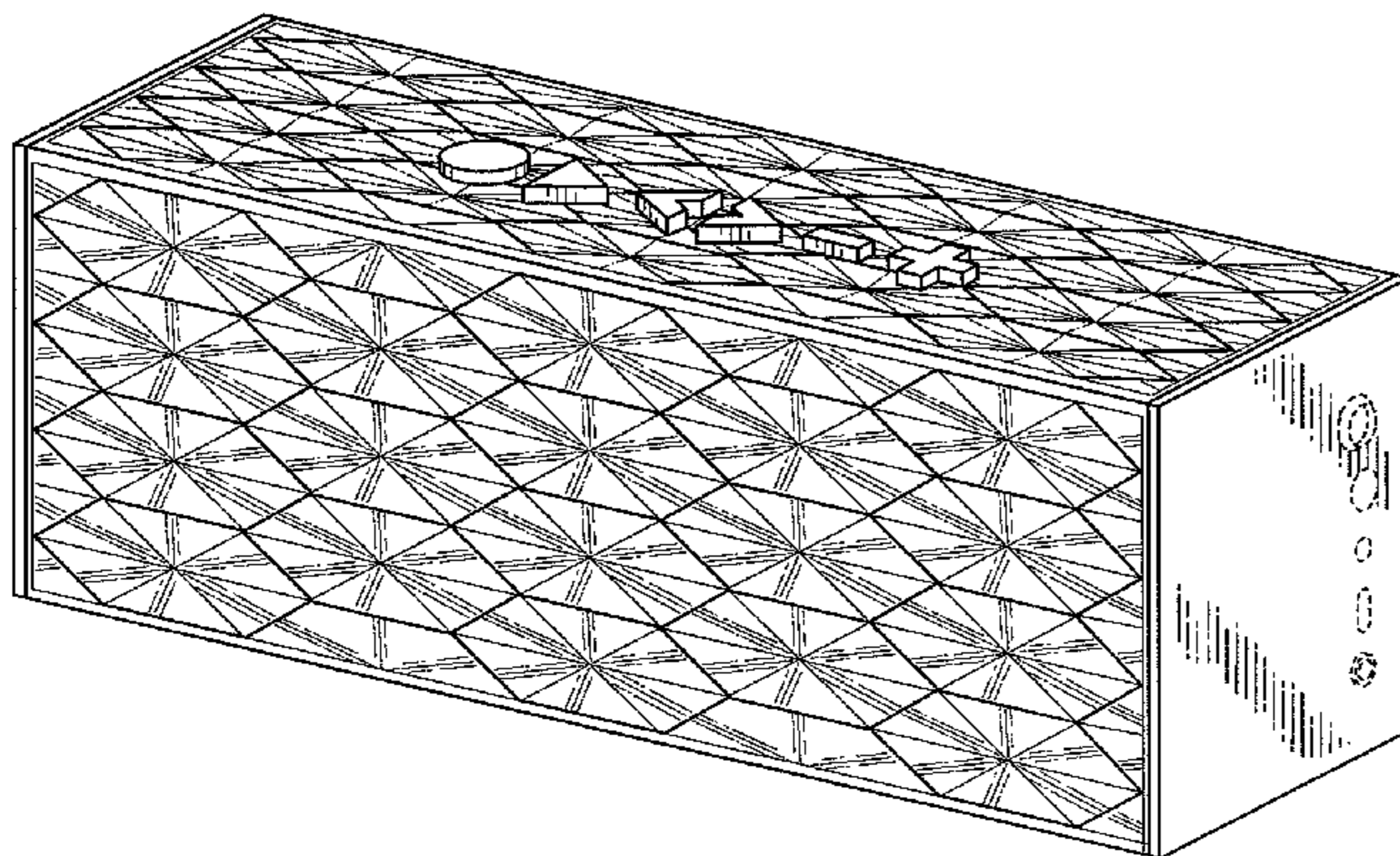

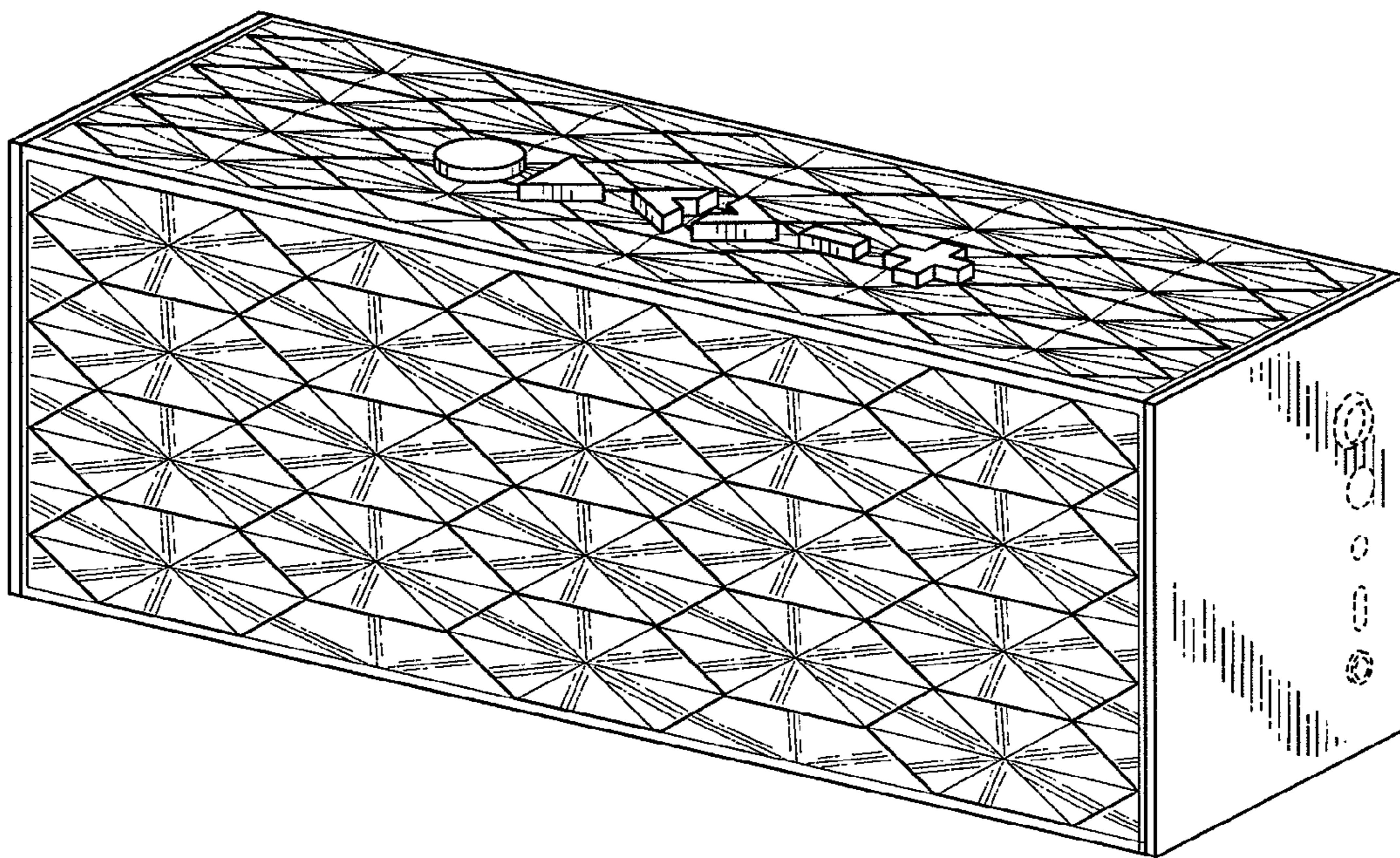

FIG. 1

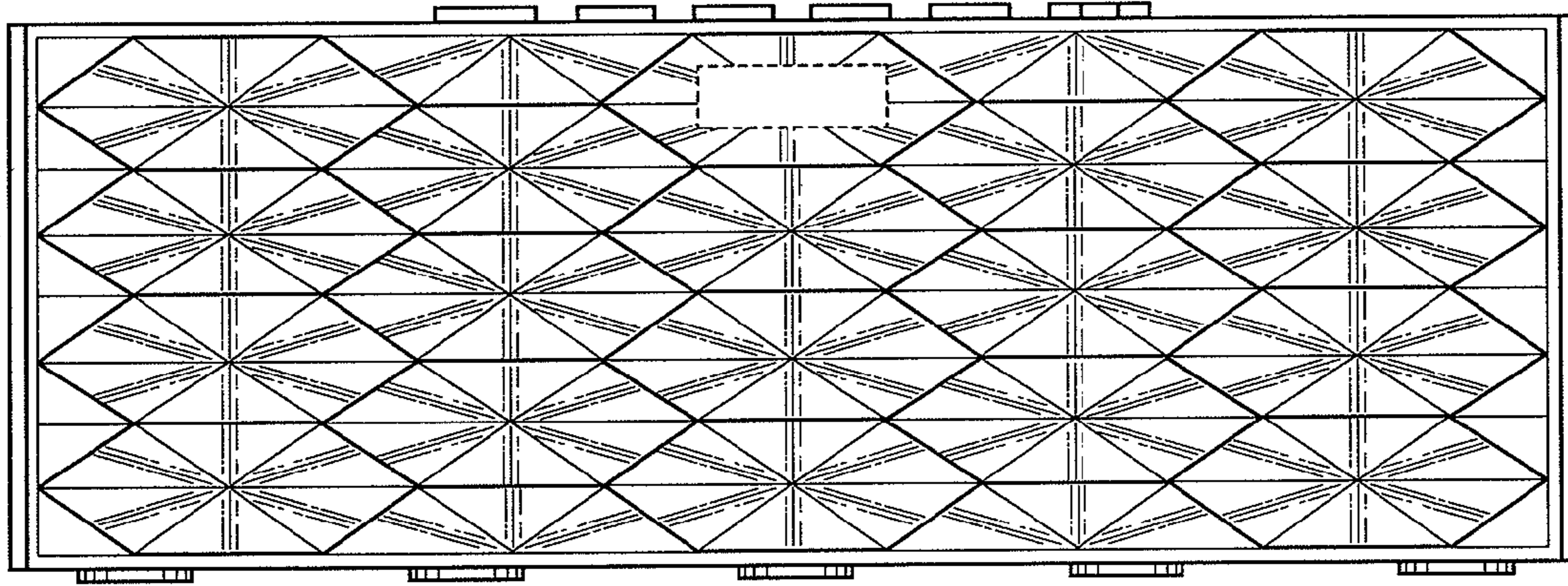

FIG. 2

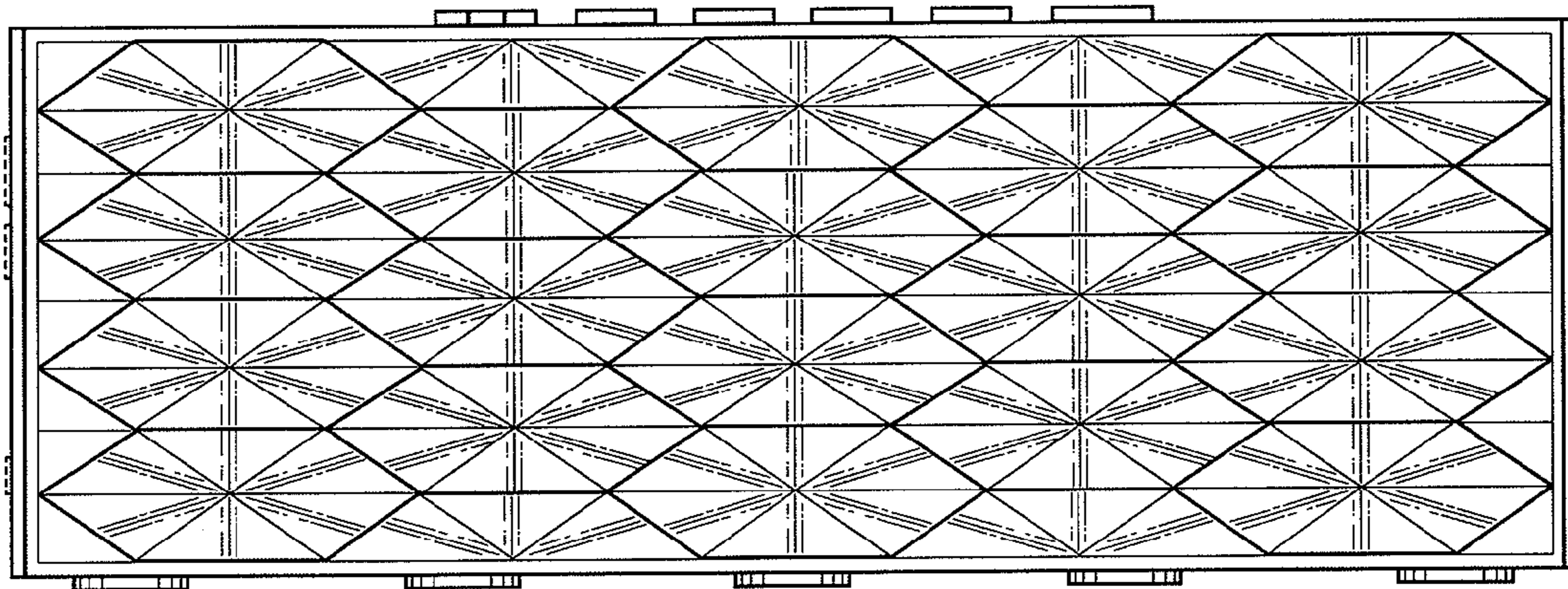

FIG. 3

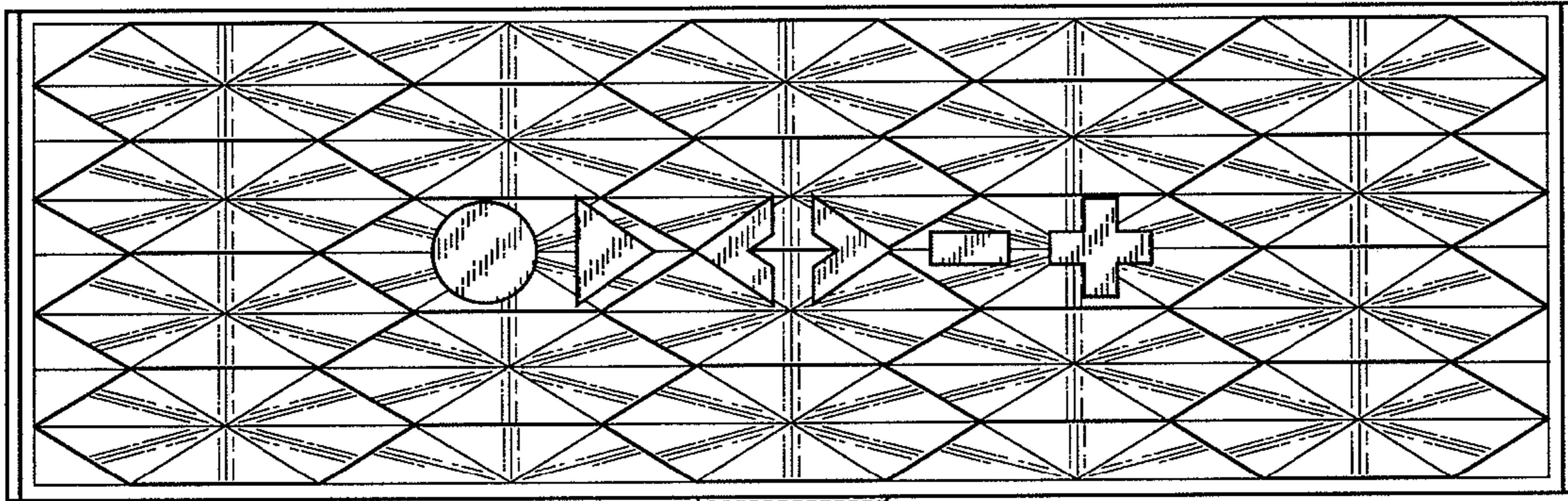

FIG. 4

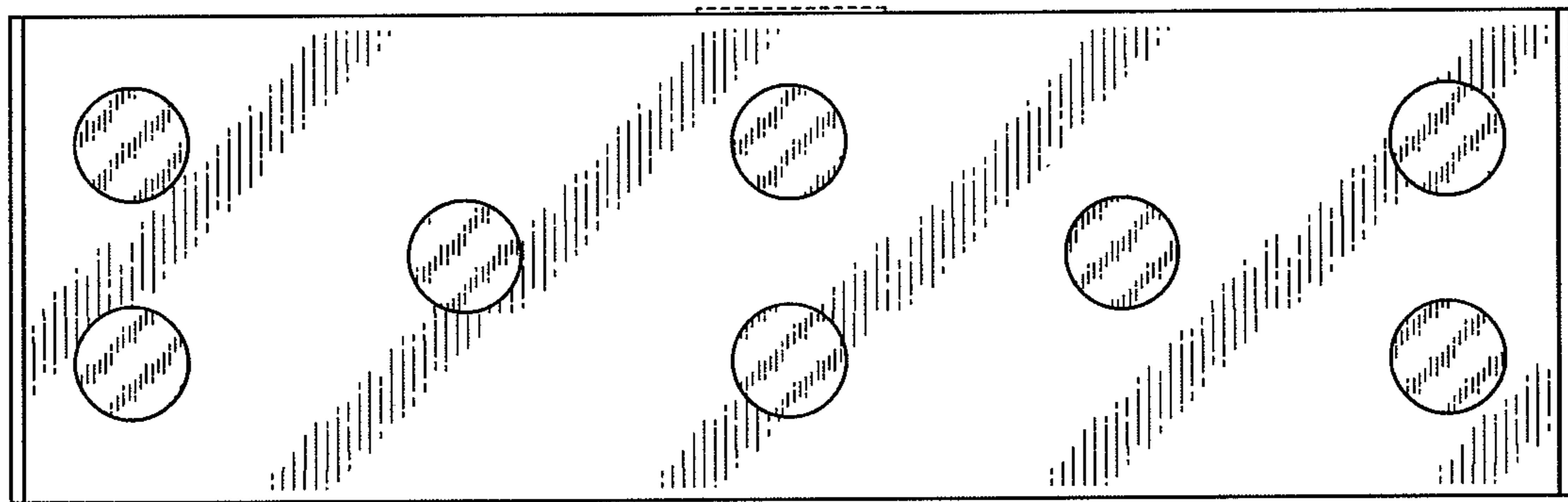

FIG. 5

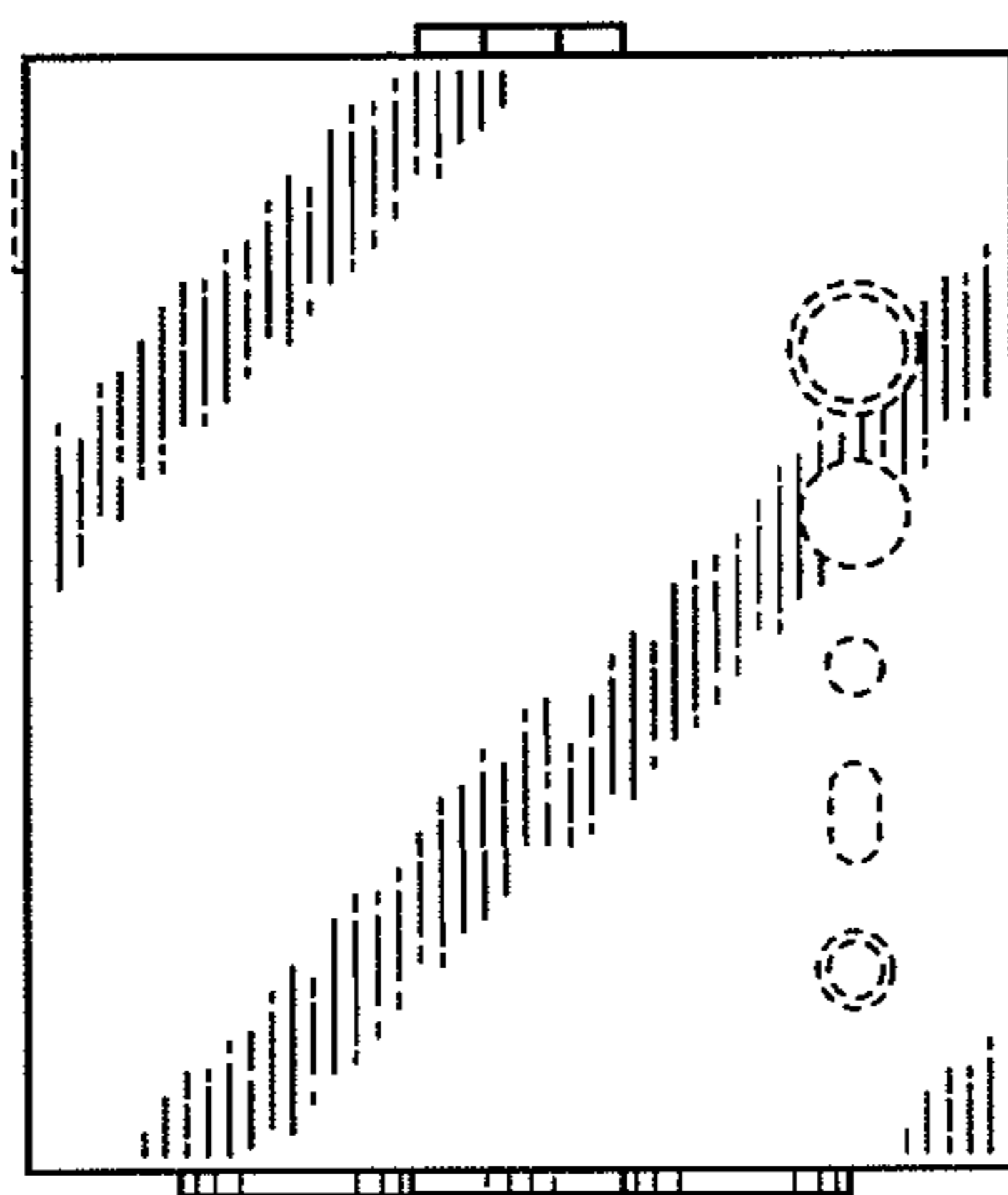

FIG. 6

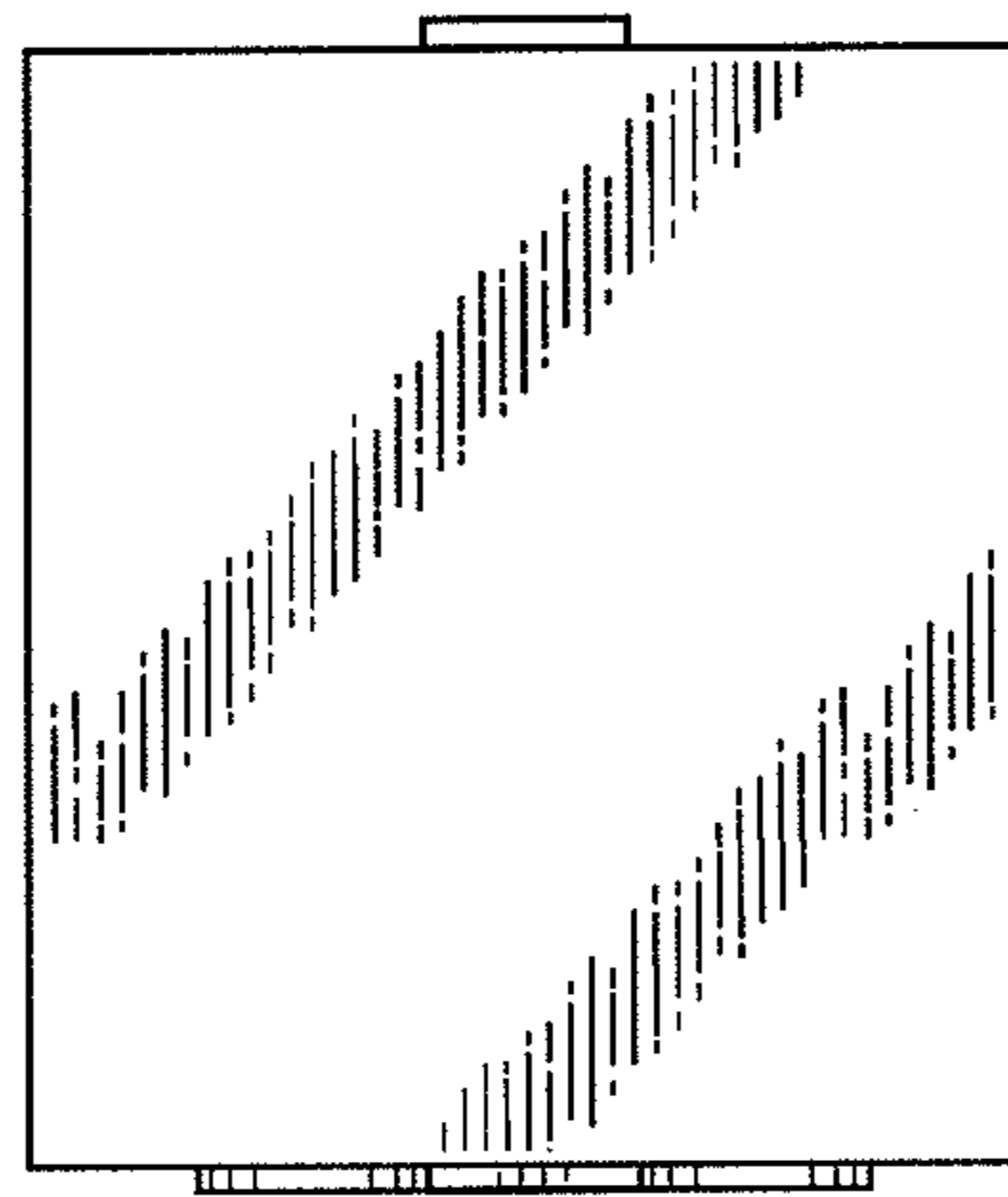

FIG. 7

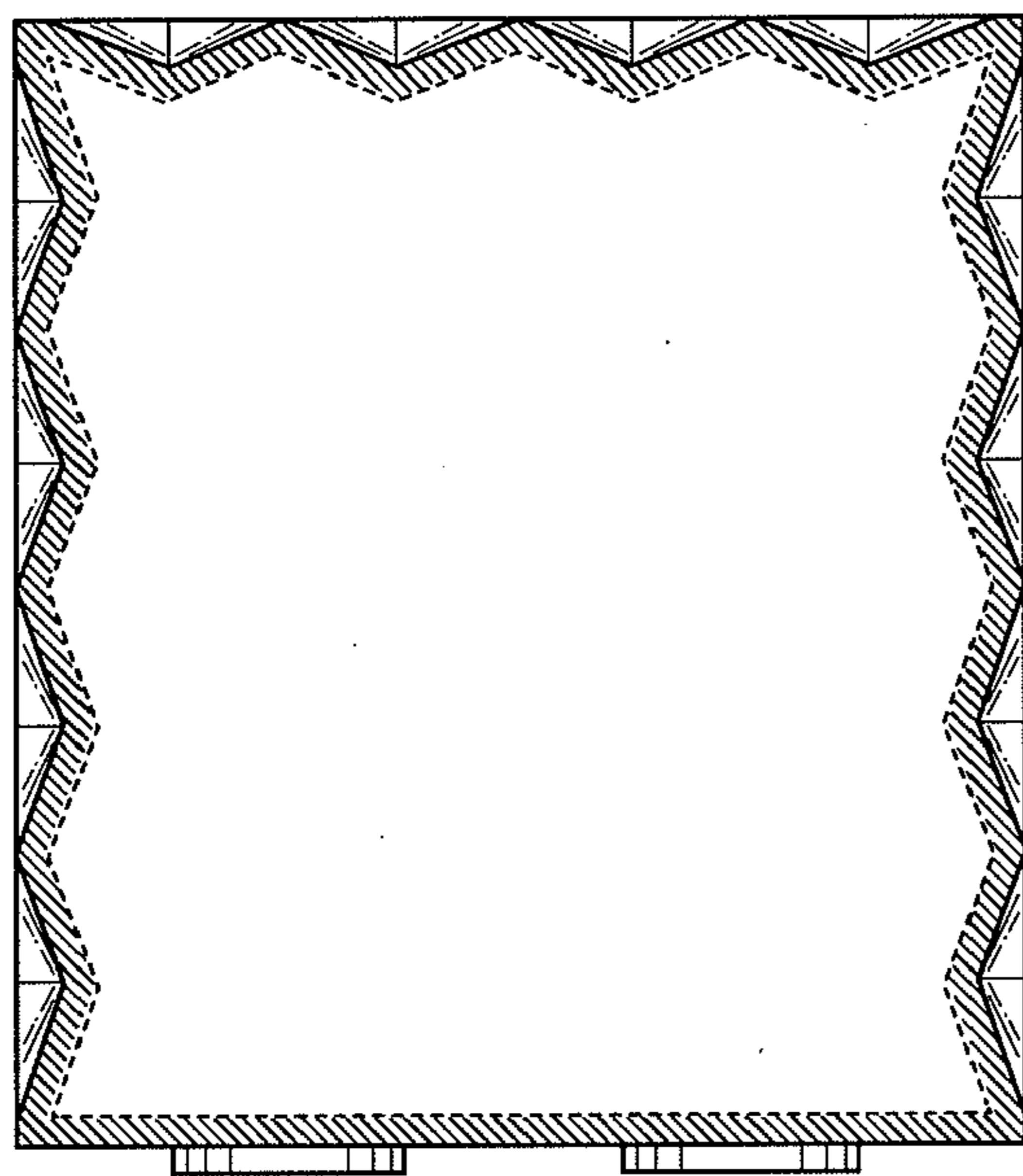
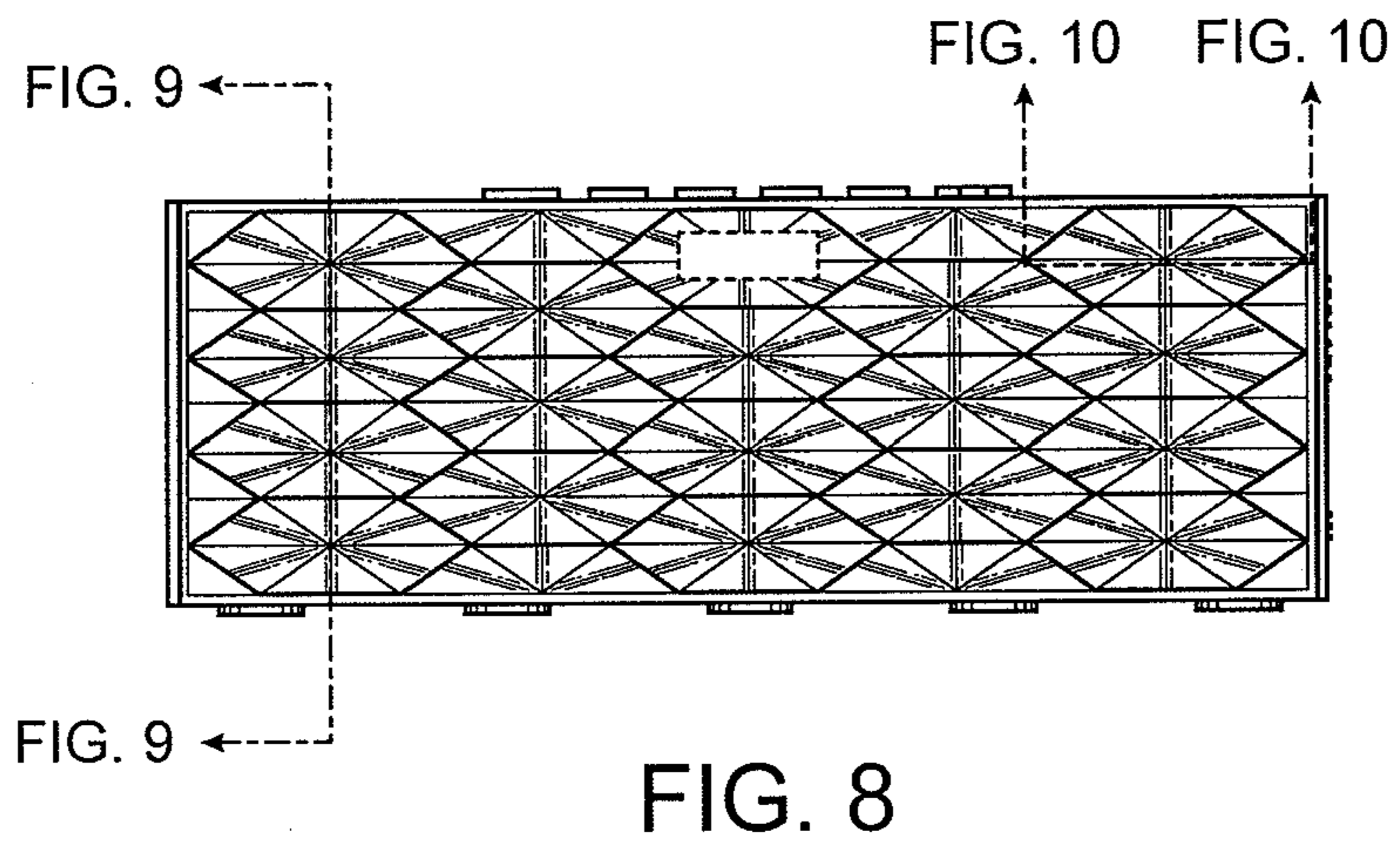

FIG. 9

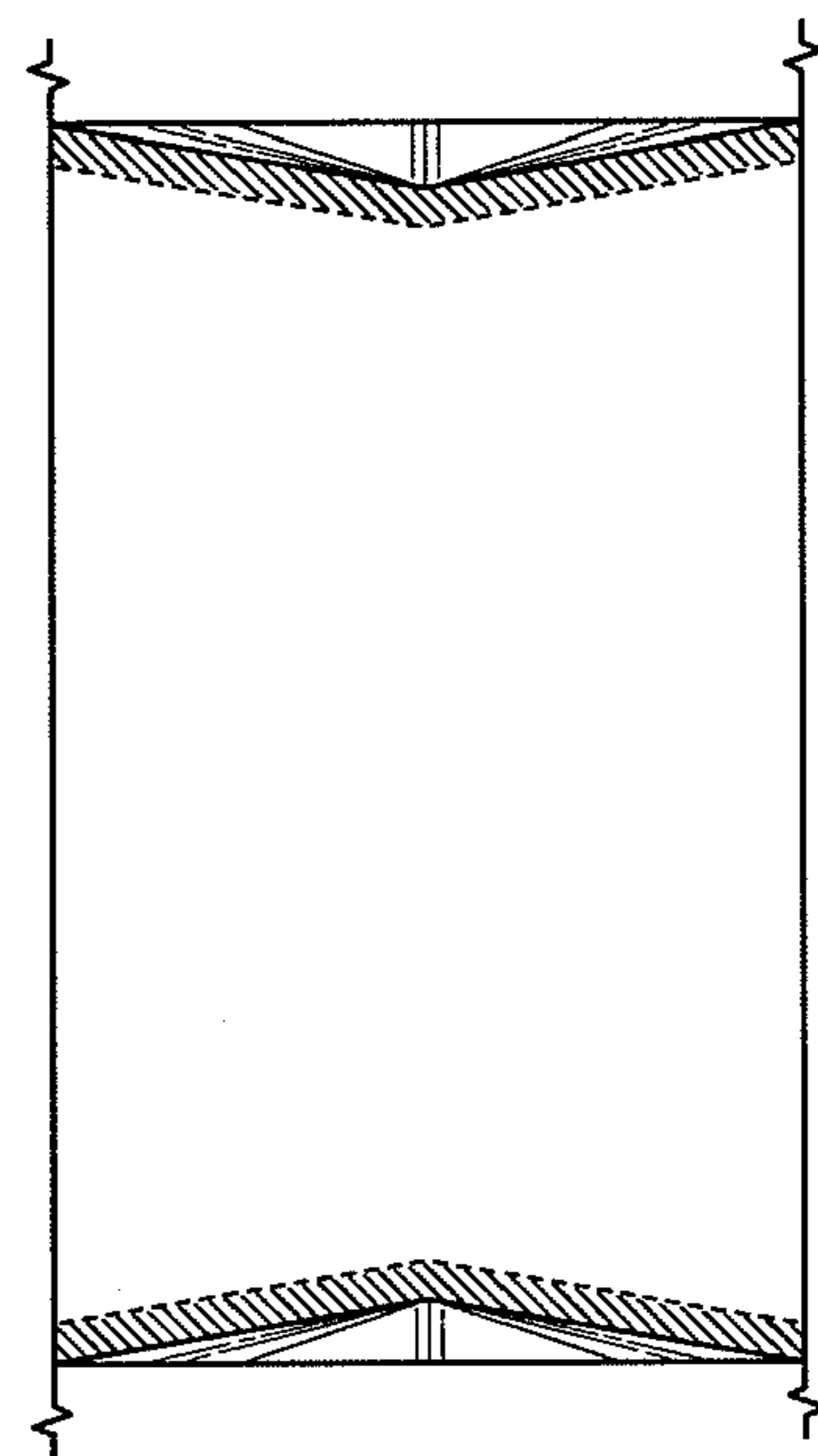

FIG. 10