



US00D678782S

(12) **United States Design Patent**
Andreotti

(10) **Patent No.:** **US D678,782 S**
(45) **Date of Patent:** **** Mar. 26, 2013**

(54) **BOTTLE**

U.S. Appl. No. 29/404,611, filed Oct. 22, 2011 on behalf of Andreotti.

(76) Inventor: **Teresa Andreotti**, Palisades Park, NJ
(US)

* cited by examiner

(**) Term: **14 Years**

Primary Examiner — Sandra Morris

(21) Appl. No.: **29/404,612**

(74) *Attorney, Agent, or Firm* — Raymond Chung

(22) Filed: **Oct. 22, 2011**

(57) **CLAIM**

I claim, the ornamental design for a bottle, as shown and described.

(51) **LOC (9) Cl.** **09-01**

(52) **U.S. Cl.** **D9/669**

(58) **Field of Classification Search** D9/600,
D9/667, 669, 682, 686–687, 694, 516, 414;
206/494, 457, 527, 540; 215/400; 220/890;
229/116.1

See application file for complete search history.

DESCRIPTION

© 2011 Teresa Andreotti. Portions of the disclosure of this patent document contain material to which a claim for copyright is made. The copyright owner has no objection to the facsimile reproduction by anyone of the patent document or the patent disclosure, as it appears in the Patent and Trademark Office patent file or records, but reserves all other copyright rights whatsoever.

(56) **References Cited**

U.S. PATENT DOCUMENTS

D10,970 S	12/1878	Weller et al.	
D340,837 S *	11/1993	Fox	D9/669
D431,187 S	9/2000	Davis	
D433,933 S	11/2000	Stefanovic	
D438,788 S *	3/2001	Rigel	D9/669
D462,898 S	9/2002	Weinstock	
D478,180 S	8/2003	Boss	
D552,481 S *	10/2007	Hough et al.	D9/669
D626,427 S	11/2010	Andreotti	

OTHER PUBLICATIONS

U.S. Appl. No. 29/404,609, filed Oct. 22, 2011 on behalf of Andreotti.
U.S. Appl. 29/404,610, filed Oct. 22, 2011 on behalf of Andreotti, et al.

FIG. 1 is an assembled, perspective view of the bottle showing my new design thereof;

FIG. 2 is an assembled, front view thereof;

FIG. 3 is an assembled, side view thereof taken from the right of FIG. 1;

FIG. 4 is an assembled, rear view thereof;

FIG. 5 is an assembled, side view thereof taken from the left of FIG. 1;

FIG. 6 is an assembled, top view thereof;

FIG. 7 is an assembled, bottom view thereof; and,

FIG. 8 is an exploded, perspective view thereof.

The broken line showing is for illustrative purposes only, and forms no part of the claimed design.

1 Claim, 7 Drawing Sheets

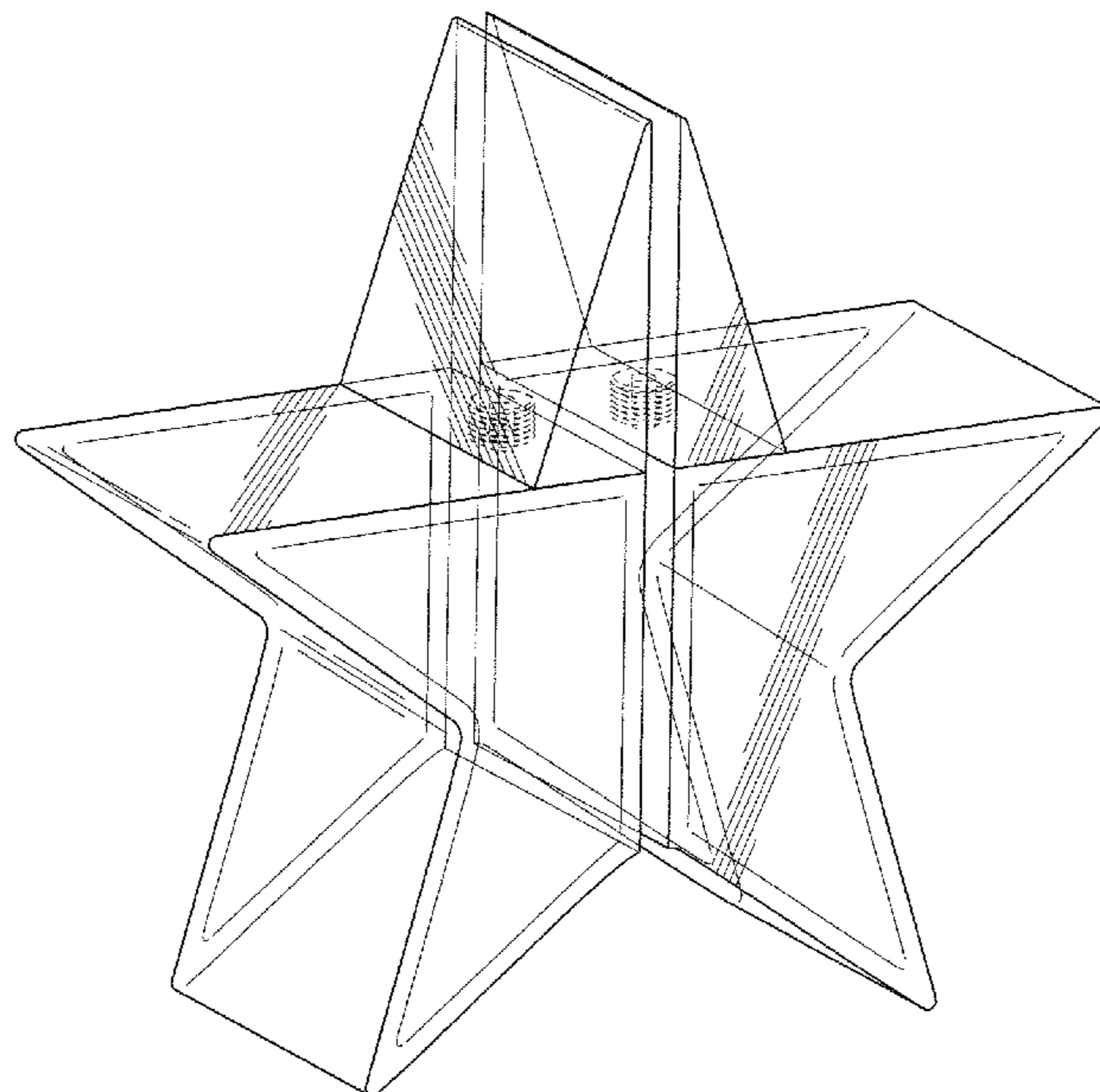

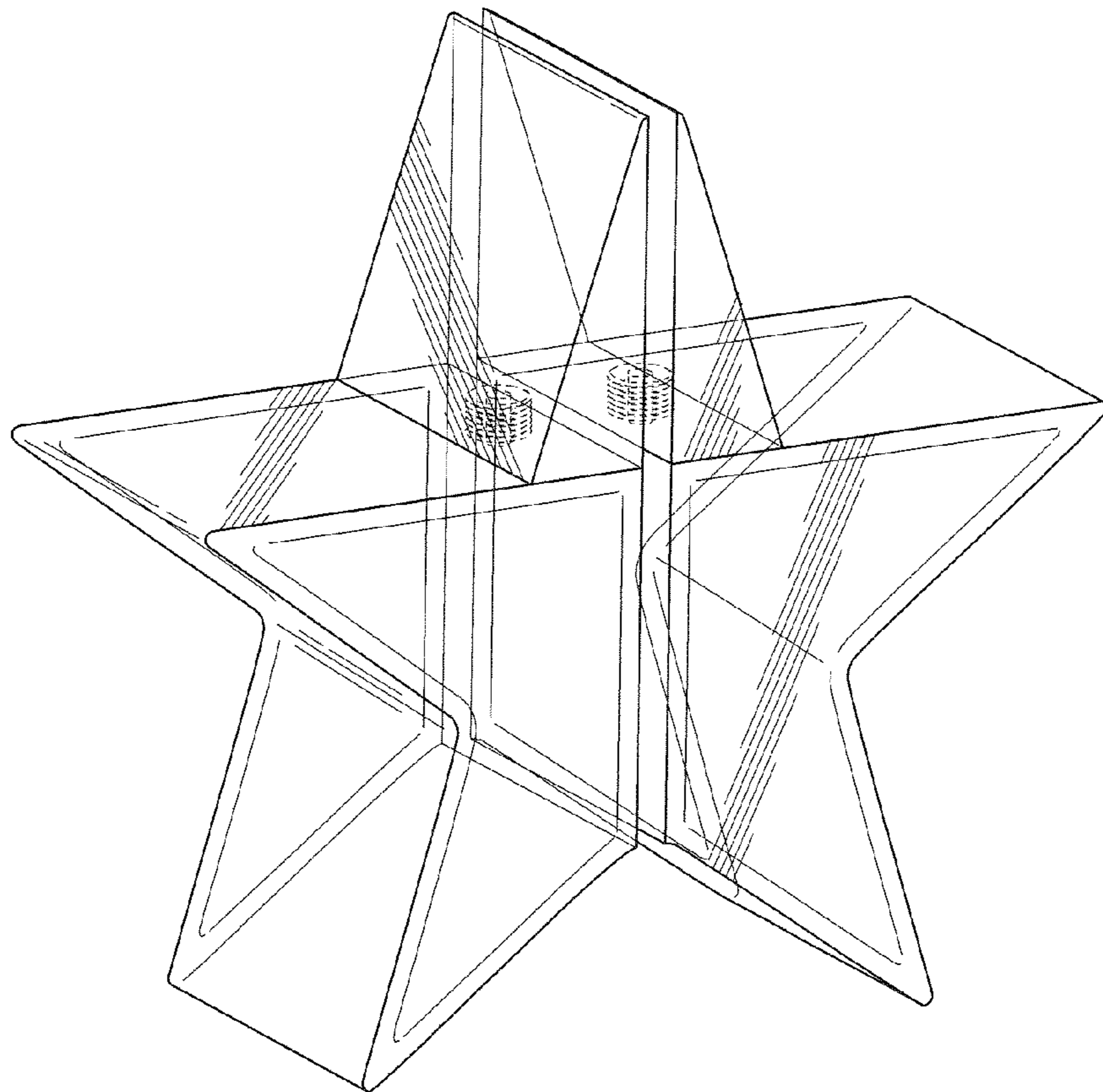

FIG. 1

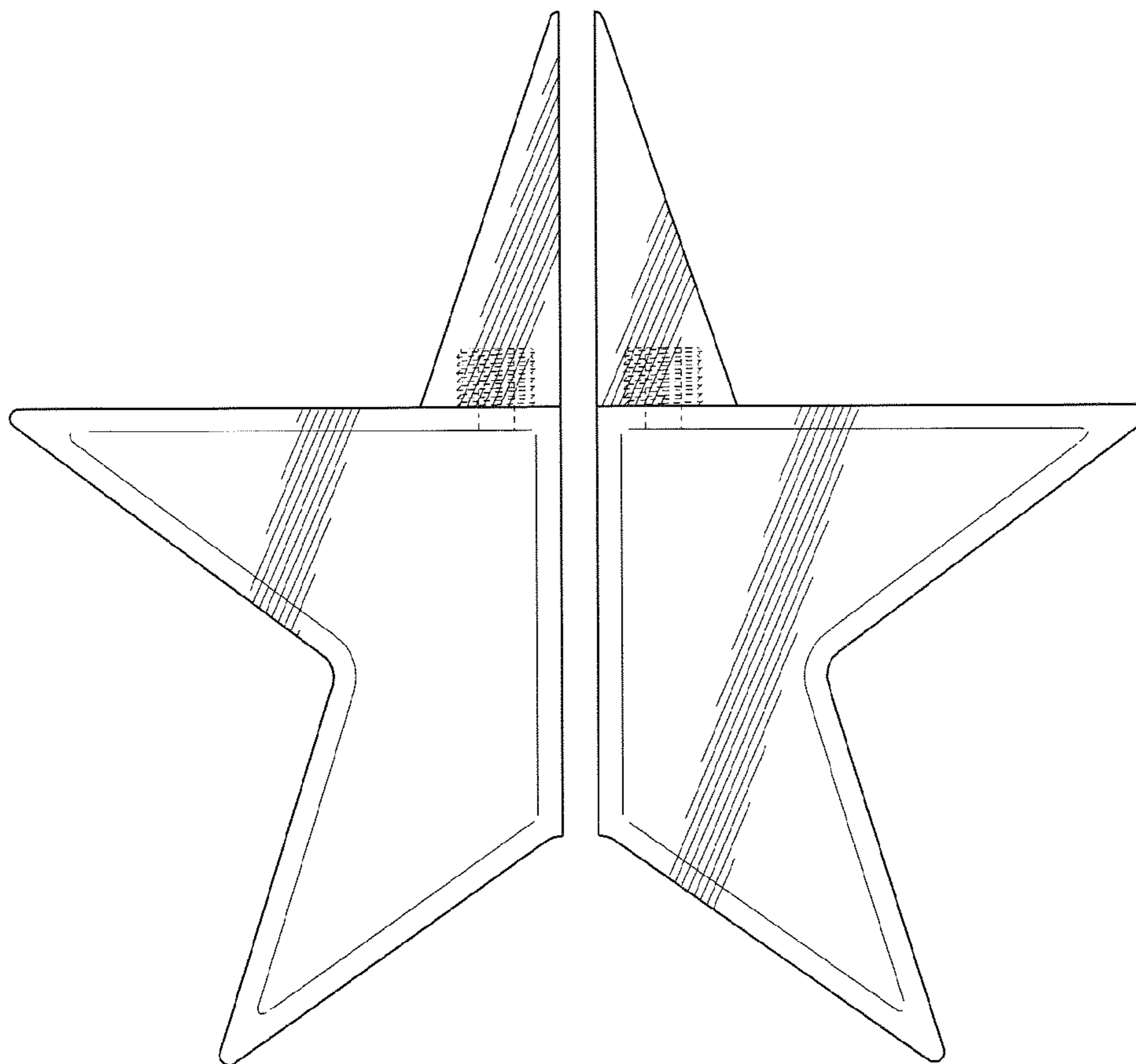

FIG. 2

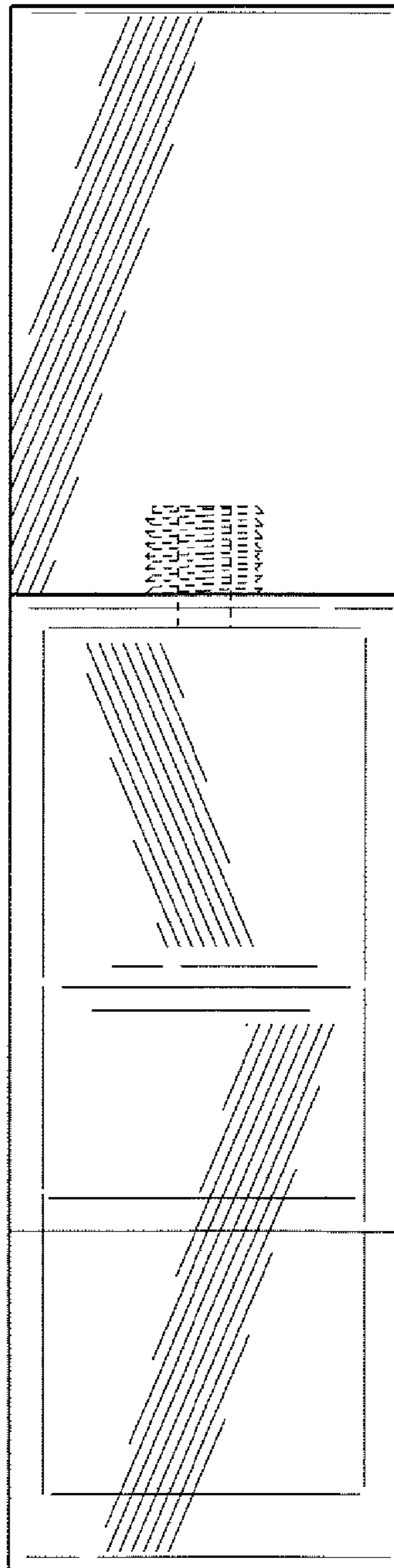

FIG. 3

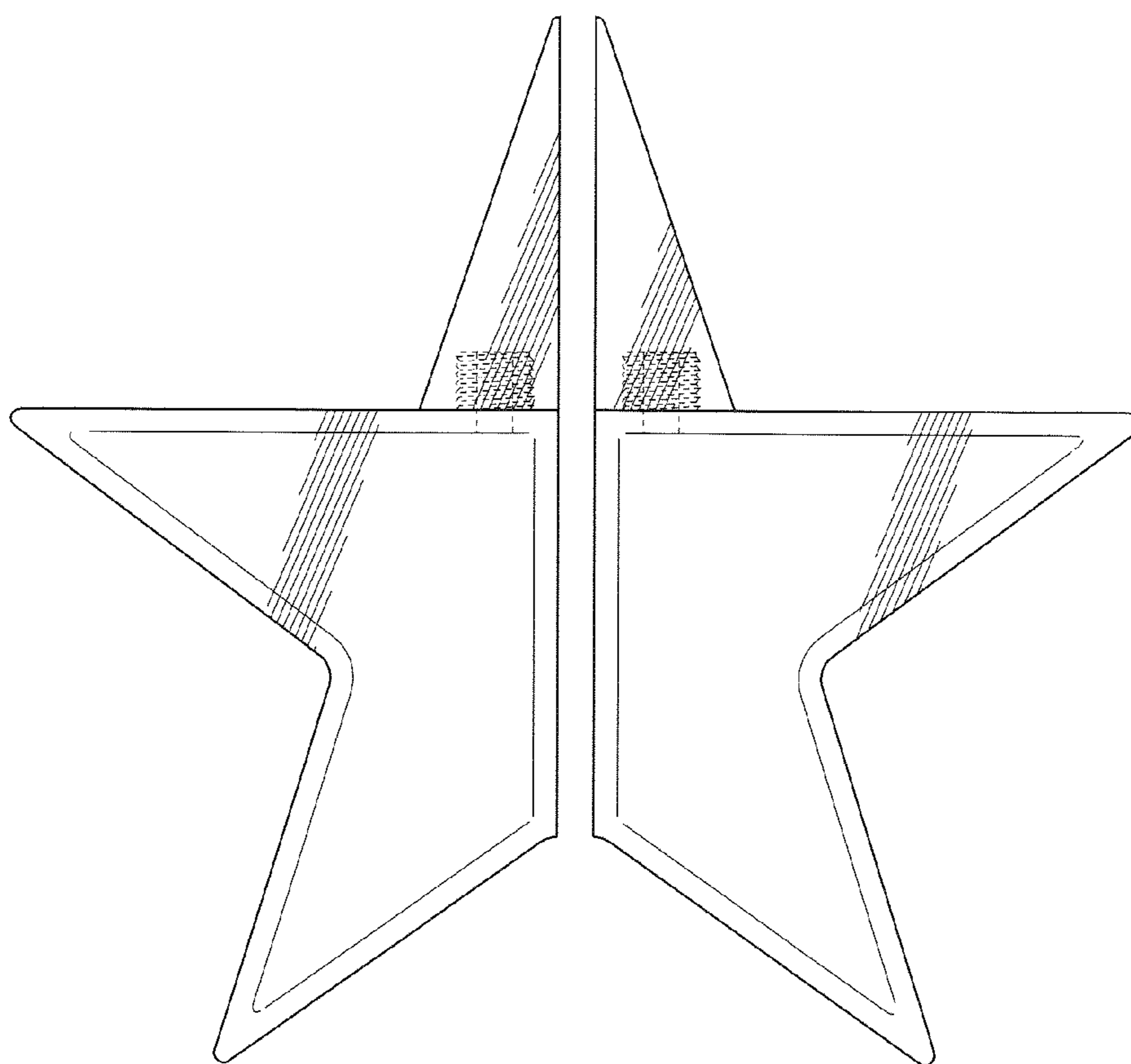

FIG. 4

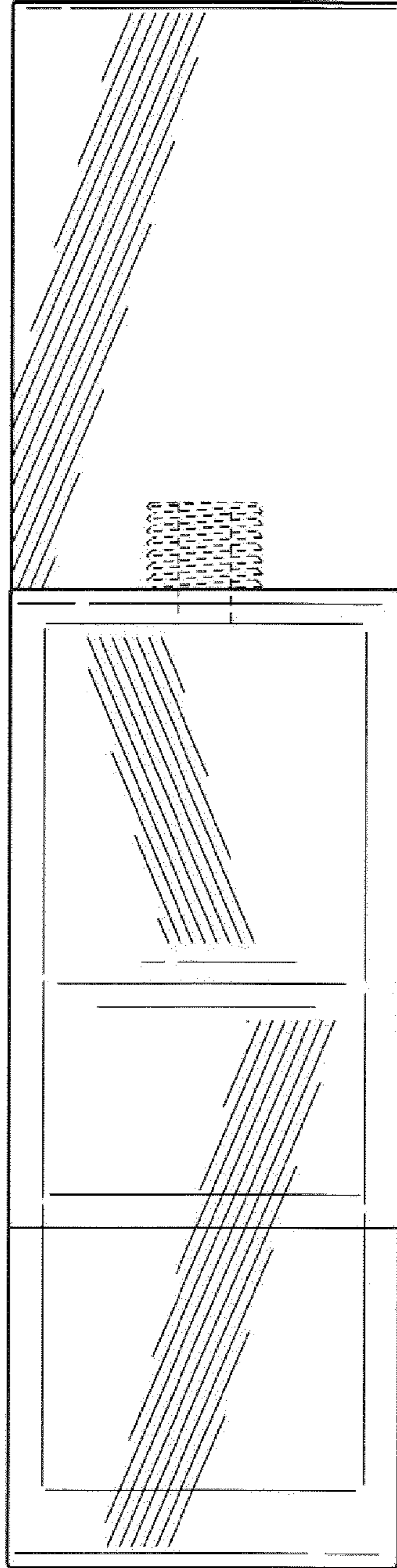

FIG. 5

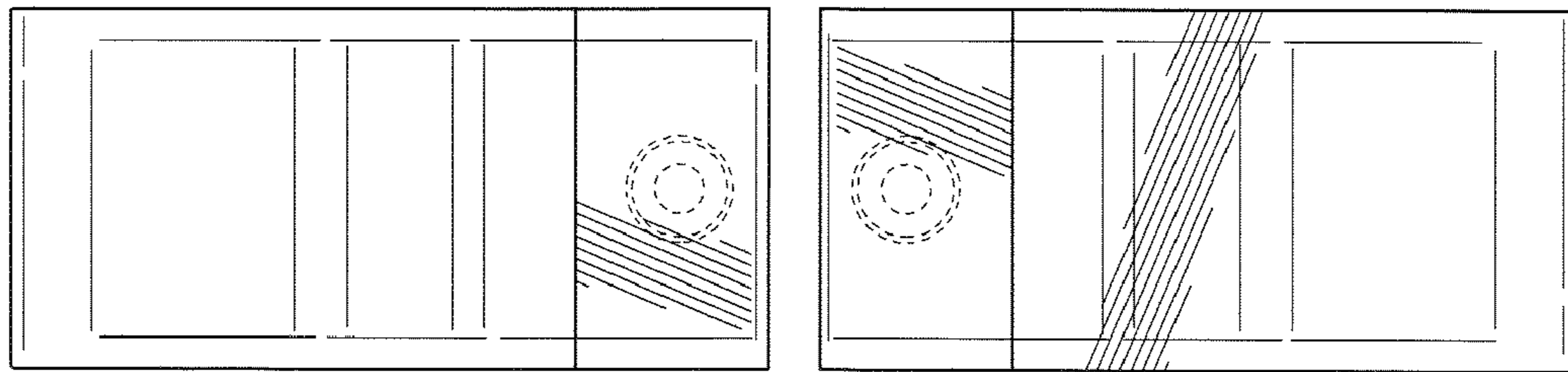

FIG. 6

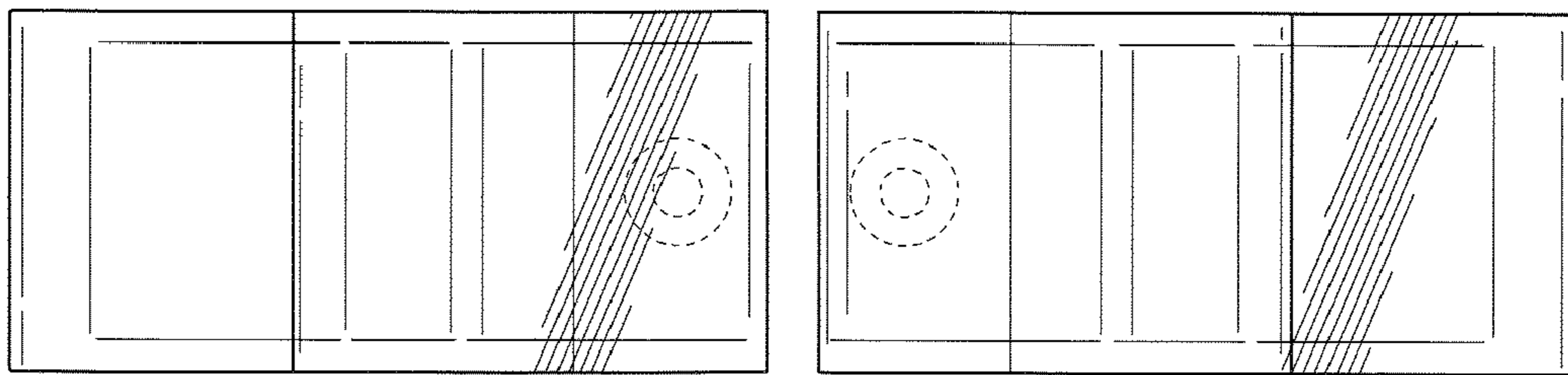

FIG. 7

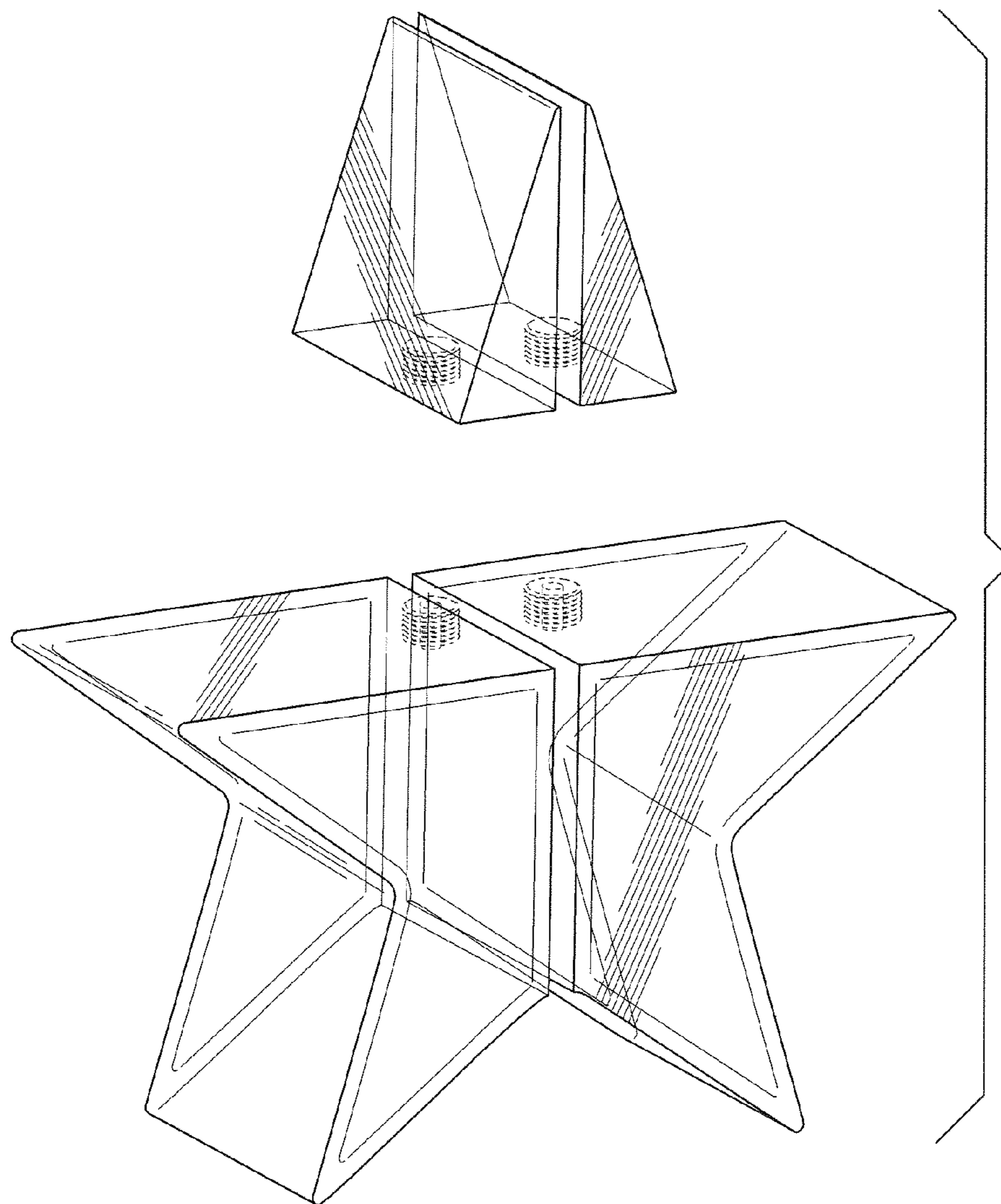

FIG. 8